

New Technical Notes

Macintosh

®

Developer Support

HW 25 - Macintosh Memory Configurations Hardware

Revised by: Jack Robson

April 1992

Prior Revisions:

Mark Baumwell, Craig Prouse, and Dennis Hescocx

Written by: Cameron Birse

November 1987

This Technical Note describes the different possible memory configurations of all models of the Macintosh family that use Single In-line Memory Modules (SIMMs) as well as the non-SIMM memory upgrade options of the Macintosh Portable and Macintosh Classic. (Special thanks to Brian Howard for the Macintosh Plus and original SE drawings, and for the inspiration for the other drawings.) This Note also describes the obstacles to using four megabit (Mbit) DRAM SIMMs in Apple Macintosh products to date.

Changes since November 1991: Corrected error on the RAM configuration chart (page 2); additional information added to Quadra 900 section (page 15).

Developer Technical Support receives numerous questions about the many different possible configurations of RAM on the different Macintosh models, so we'll attempt to answer these questions in this Technical Note, as well as to provide a showcase for some outstanding Macintosh Plus and SE artwork by Apple engineer Brian Howard. Interested readers should refer to the *Guide to the Macintosh Family Hardware*, Second Edition, which contains much more detail on the memory configurations and specifications for all Macintosh models released to date. For information on the newer Macintosh models not mentioned in the *Guide to the Macintosh Family Hardware*, please refer to the companion developer notes for those particular products.

RAM Configuration Chart

Caveat: The upper physical RAM totals expressed here assume the use and compatibility of 4 and 16 MB SIMMs. Since Apple has not yet thoroughly tested SIMMs larger than 1 MB with our Macintosh line, these upper limits should be considered theoretical. At this point Apple cannot claim that these SIMM sizes will work, nor can we guarantee any information in this Tech Note that pertains to the use of 4 and 16 MB SIMMs (read: use them at your own risk). All numbers are expressed in terms of megabytes (MB) unless otherwise noted.

| | Permanent RAM | No of SIMM slots | Allowable SIMM sizes | Physical RAM Totals | Req. Speed | TN Page |
|----------------------------|------------------|---------------------|---------------------------|--|---------------|------------|
| Plus | 0 | 4 | 256K,1 | 512K,1,2,2.5,4 | 150 ns | 3,4 |
| SE | 0 | 4 | 256K,1 | 512K,1,2,2.5,4 | 150 ns | 3,5,6 |
| Classic | 1 | 2* | 256K,1 | 1,2,2.5,4 | 150 ns | 3,8 |
| Classic II [†] | 2 | 2 | 1,2,4 | 2,4,6,10 | 100 ns | 17 |
| SE/30 | 0 | 8 | 256K,1,4,16 | 1,2,4,5,8...128 [†] | 120 ns | 7,9 |
| II | 0 | 8 | 256K,1,4,16 ^{††} | 1,2,4,5,8...68 [†] | 120 ns | 7,9 |
| IIx | 0 | 8 | 256K,1,4,16 | 1,2,4,5,8...128 [†] | 120 ns | 7,9 |
| IIcx | 0 | 8 | 256K,1,4,16 | 1,2,4,5,8...128 [†] | 120 ns | 7,12 |
| LC [‡] | 2 | 2 | 1,2,4,16 | 2,4,6,10 | 100 ns | 8,10 |
| IIisi [‡] | 1 | 4 | 256K,512K,1,2,4,16 | 1,2,3,5,9,17...65 | 100 ns | 8,10 |
| IIici [‡] | 0 | 8 | 256K,1,4,16 | 1,2,4,5,8,16, 10,17,20,32...128 | 80 ns | 10,12 |
| Portable | 1 | 0** | n/a | 1,2,3,4,5,6,7,8,9*** | 100 ns | 11,12 |
| Portable (backlit) | 1 | 0** | n/a | 1,2,3,4,5,6,7,8*** | 100 ns | |
| IIifx [‡] | 0 | 8 | 1,4,16 | 4,8,16,20,32...128 | 80 ns | 13,14 |
| Quadra 700 [‡] | 4 | 4 | 1,4,16 | 4,8,20...68 | 80 ns | 16 |
| Quadra 900 [‡] | 0 | 16 | 1,4,16 | 4,8,12,16,20, 24,28,32,36, 40,48,52,64...256 | 80 ns | 15 |
| PowerBook 100 | 2 | 0** | n/a | 2,4,6,8 | n/a | 19 |
| PowerBook 140 [‡] | 2 | 0** | n/a | 2,4,6,8 | n/a | 18 |
| PowerBook 170 [‡] | 2 | 0** | n/a | 2,4,6,8 | n/a | 18 |

*The Macintosh Classic has 1 MB of RAM soldered onto the motherboard. Additional RAM can be added by using an expansion card. Apple Macintosh Classic 1 MB Memory Expansion Card has 1 MB of additional RAM and two SIMM connectors.

**The Macintosh Portable and the PowerBook computers allow you to add RAM by using an expansion card. These expansion cards can have from 1 MB to 4 MB of memory for the Portable, 1 MB to 3 MB for the backlit Portable, and 2, 4, or 6 MB for the PowerBook line.

***If the PDS slot is used for other peripherals, then the maximum amount of RAM (by using a RAM expansion card) is 5 MB for the Macintosh Portable, and 4 MB for the backlit Macintosh Portable.

‡These systems have ROMs that are capable of 32-bit addressing (when using the appropriate system software, such as System 7 or A/UX).

†The Macintosh II, IIx, IIcx, and SE/30 can benefit from larger SIMM sizes and address more than 8 MB of RAM by using either A/UX or the 32-bit addressing software solution called MODE32™ in conjunction with System 7. This will allow you to address up to 128 MB on the IIx, IIcx, and SE/30, and up to 68 MB on the Macintosh II (four 1 MB SIMMs in Bank A, four 16 MB SIMMs in Bank B). If you use SIMMs larger than 1 MB on the Macintosh II or IIx, you must have a PMMU and special SIMMs with PAL™ logic on them. Please refer to pages 7 and 20 of this Tech Note for more information on these SIMMs. MODE32, by Connectix, has been made available at no charge to all Apple customers. For more information about MODE32, please contact Apple at 1-800-776-2333.

††SIMMs greater than 1 MB can only be in SIMM Bank B. Please refer to Page 7 for more Macintosh II information.

Warning: Because the video monitor is built in, there are dangerous voltages inside the cases of the Macintosh Plus, SE, Classic, Classic II, and SE/30 computers. The video tube and video circuitry may hold dangerous charges long after the computer's power is turned off. Opening the case of these computers requires special tools and may invalidate your warranty. Installation of RAM in the SIMM sockets in these computers should be done by qualified service personnel only.

Macintosh Plus

The Macintosh Plus has the following possible configurations (see Figure 1):

- 512K, using two 256 Kbit SIMMs
- 1 MB, using four 256 Kbit SIMMs
- 2 MB, using two 1 Mbit SIMMs
- 2.5 MB, using two 1 Mbit SIMMs and two 256 Kbit SIMMs
- 4 MB, using four 1 Mbit SIMMs

It is important to place the SIMMs in the correct location when using a combination of SIMM sizes, as in the 2.5 MB example, and to make sure the right resistors are cut. Refer to Figure 1 for the correct location of the SIMMs and size resistors.

Macintosh SE

The Macintosh SE configurations (the original motherboard as well as the revised motherboard with a memory jumper selector) are the same as the Macintosh Plus, except physical locations on the motherboard are different. In addition, memory configurations with only two SIMMs (for example, 512K and 2 MB) use slots 3 and 4 on the revised SE motherboard instead of slots 1 and 2 like the original motherboard and Macintosh Plus. Refer to Figures 2 and 3 for the correct locations and settings.

Macintosh Classic

The Macintosh Classic has the following possible configurations (see Figure 4):

- 1 MB, using eight 128 Kbit DRAMs soldered to the motherboard
- 2 MB, using the memory expansion card and setting the jumper to “SIMM NOT INSTALLED”
- 2.5 MB, using two 256 Kbit SIMMs on the memory expansion card and setting the jumper to “SIMM INSTALLED”
- 4 MB, using two 1 Mbit SIMMs on the memory expansion card and setting the jumper to “SIMM INSTALLED”

When adding SIMMs to the memory expansion card, use either two 256 Kbit or two 1 Mbit parts rated at 120 ns or faster.

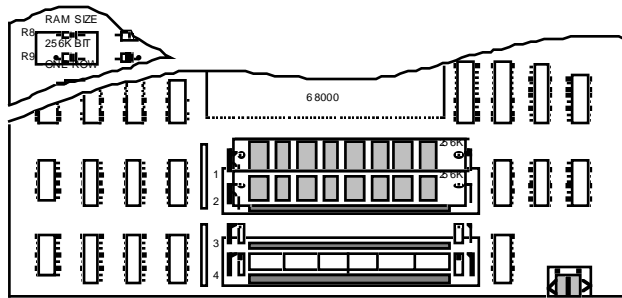

System Memory Size 512K

SIMMs Configuration
 Row 1 (SIMMs 1 & 2): 256K
 Row 2 (SIMMs 3 & 4): Not Installed

RAM SIZE Resistors
 256 Kbit (R8): 150 Ohms
 One Row (R9): 150 Ohms

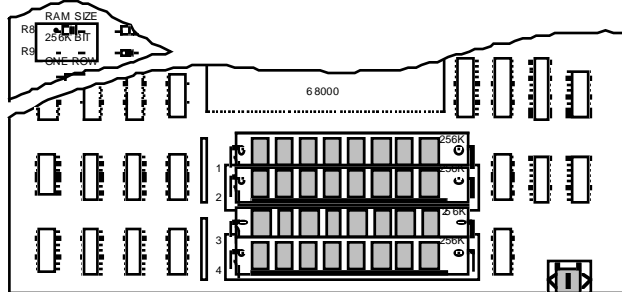

System Memory Size 1MB

SIMMs Configuration
 Row 1 (SIMMs 1 & 2): 256K
 Row 2 (SIMMs 3 & 4): 256K

RAM SIZE Resistors
 256 Kbit (R8): 150 Ohms
 One Row (R9): Not Installed

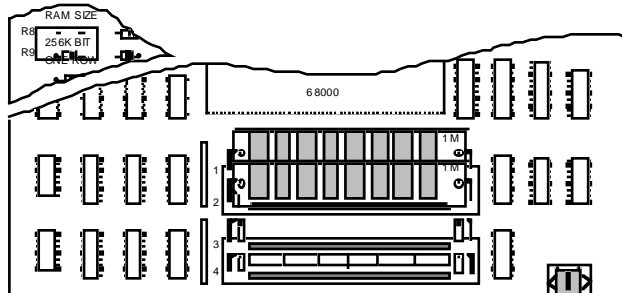

System Memory Size 2MB

SIMMs Configuration
 Row 1 (SIMMs 1 & 2): 1MB
 Row 2 (SIMMs 3 & 4): Not Installed

RAM SIZE Resistors
 256 Kbit (R8): Not Installed
 One Row (R9): 150 Ohms

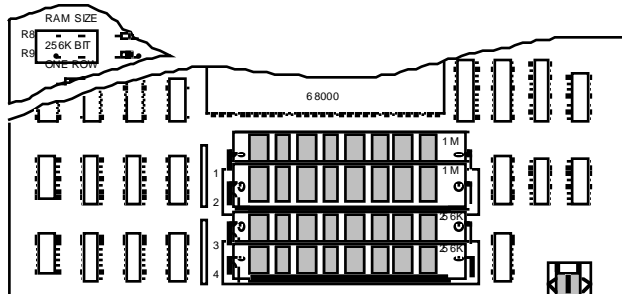

System Memory Size 25MB

SIMMs Configuration
 Row 1 (SIMMs 1 & 2): 1MB
 Row 2 (SIMMs 3 & 4): 256K

RAM SIZE Resistors
 256 Kbit (R8): Not Installed
 One Row (R9): Not Installed

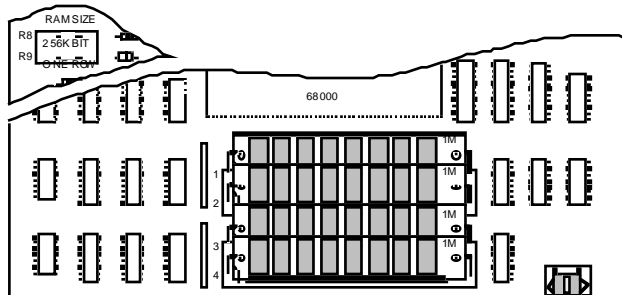

System Memory Size 4MB

SIMMs Configuration
 Row 1 (SIMMs 1 & 2): 1MB
 Row 2 (SIMMs 3 & 4): 1MB

RAM SIZE Resistors
 256 Kbit (R8): Not Installed
 One Row (R9): Not Installed

(SIMMs must be 150 nS RAS-access time or faster, and the same speed within a row.)

Figure 1 - Macintosh Plus Memory Configurations

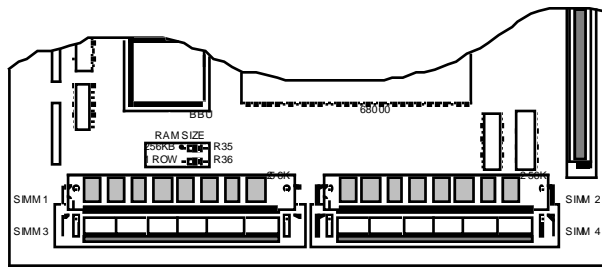

System Memory Size 512K
 SIMMs Configuration
 Row 1 (SIMMs 1 & 2) 256K
 Row 2 (SIMMs 3 & 4) Not Installed
 RAM SIZE Resistors
 256 Kb i (R35) 150 Ohms
 One Row (R36) 150 Ohms

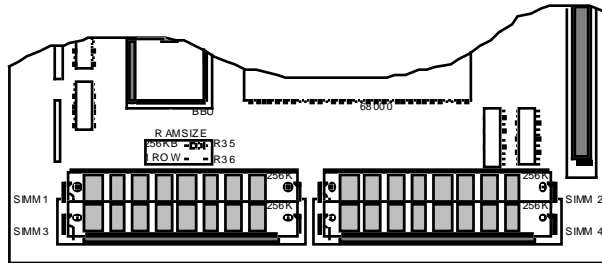

System Memory Size 1 MB
 SIMMs Configuration
 Row 1 (SIMMs 1 & 2) 256K
 Row 2 (SIMMs 3 & 4) 256K
 RAM SIZE Resistors
 256 Kb i (R35) 150 Ohms
 One Row (R36) Not Installed

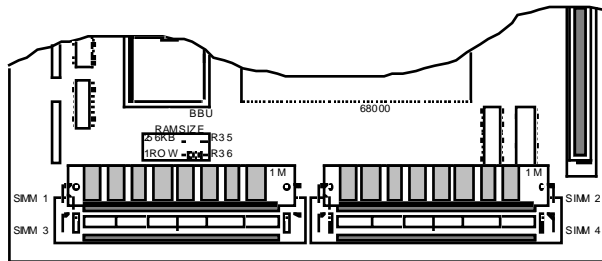

System Memory Size 2 MB
 SIMMs Configuration
 Row 1 (SIMMs 1 & 2) 1 MB
 Row 2 (SIMMs 3 & 4) Not Installed
 RAM SIZE Resistors
 256 Kb i (R35) Not Installed
 One Row (R36) 150 Ohms

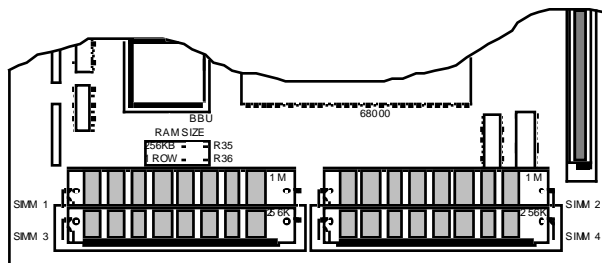

System Memory Size 2.5 MB
 SIMMs Configuration
 Row 1 (SIMMs 1 & 2) 1 MB
 Row 2 (SIMMs 3 & 4) 256K
 RAM SIZE Resistors
 256 Kb i (R35) Not Installed
 One Row (R36) Not Installed

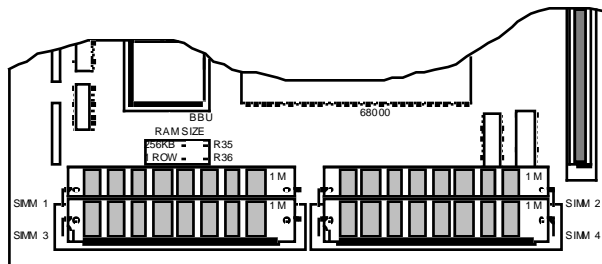

System Memory Size 4 MB
 SIMMs Configuration
 Row 1 (SIMMs 1 & 2) 1 MB
 Row 2 (SIMMs 3 & 4) 1 MB
 RAM SIZE Resistors
 256 Kb i (R35) Not Installed
 One Row (R36) Not Installed

(SIMMs must be 150 nS RAS-access time or faster, and the same speed within a row.)

Figure 2 – Macintosh SE Memory Configurations

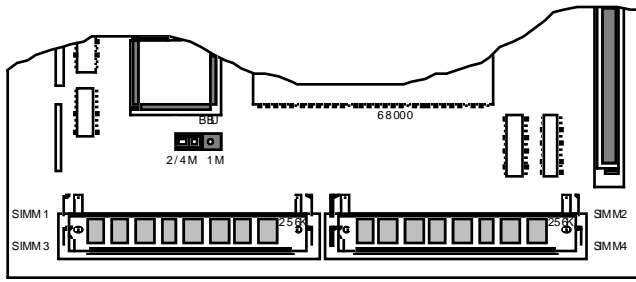

System Memory Size 512K
 SIMMs Configuration
 Row 1 (SIMMs 1 & 2): Not Installed
 Row 2 (SIMMs 3 & 4): 256 K
 Jumper on 2/4M

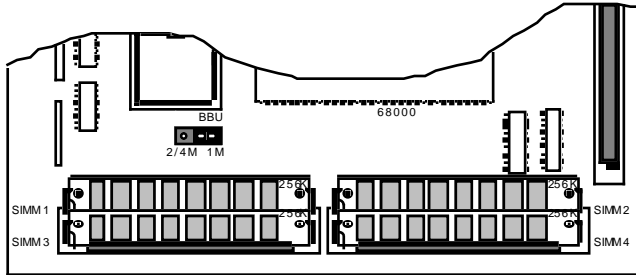

System Memory Size 1 MB
 SIMMs Configuration
 Row 1 (SIMMs 1 & 2): 256 K
 Row 2 (SIMMs 3 & 4): 256 K
 Jumper on 1M

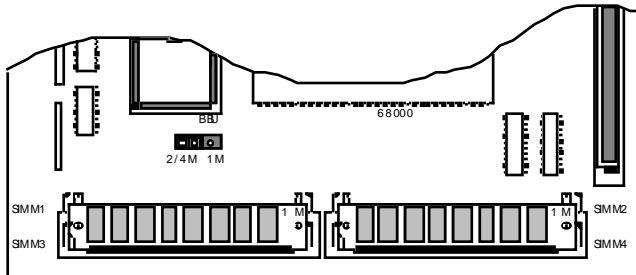

System Memory Size 2 MB
 SIMMs Configuration
 Row 1 (SIMMs 1 & 2): Not Installed
 Row 2 (SIMMs 3 & 4): 1 MB
 Jumper on 2/4M

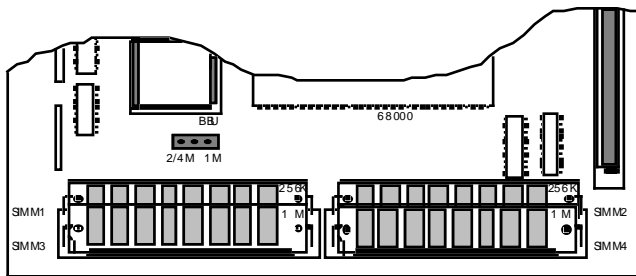

System Memory Size 2.5 MB
 SIMMs Configuration
 Row 1 (SIMMs 1 & 2): 256K
 Row 2 (SIMMs 3 & 4): 1 MB
 Jumper off

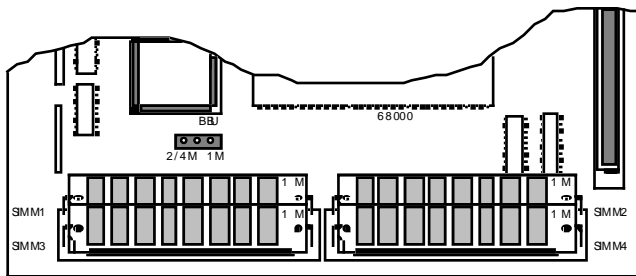

System Memory Size 4 MB
 SIMMs Configuration
 Row 1 (SIMMs 1 & 2): 1 MB
 Row 2 (SIMMs 3 & 4): 1 MB
 Jumper off

(SIMMs must be 150 nS RAS-access time or faster, and the same speed within a row.)

Figure 3 - Macintosh SE (with jumper) Memory Configurations

Macintosh SE/30, II, IIx, and IIcx

Since these machines use a 32-bit data bus with eight-bit SIMMs, you must always upgrade memory in four SIMM chunks. The eight SIMM connectors are divided into two banks of four SIMM slots, Bank A and Bank B.

On the Macintosh SE/30, Bank A is located next to the ROM SIMM while Bank B is next to the 68882 coprocessor. On the Macintosh II and IIx, Bank A is the bank closest to the edge of the board, while on the Macintosh IIcx, Bank A is the bank closest to the disk drives and power supply. Refer to Figure 5 for the proper locations of Banks A and B on the SE/30, II, and IIx, and refer to Figure 6 for the proper locations on the IIcx.

Unlike the Macintosh Plus and the Macintosh SE, the Macintosh II and IIx have no resistors to cut and no jumpers to set; you need only install the SIMMS in the correct banks and you'll be up and running. You can implement the following configurations:

- 1 MB, using four 256 Kbit SIMMs in Bank A
- 2 MB, using eight 256 Kbit SIMMs in Banks A and B
- 4 MB, using four 1 Mbit SIMMs in Bank A
- 5 MB, using four 1 Mbit SIMMs in Bank A and four 256 Kbit SIMMs in Bank B
- 8 MB, using eight 1 Mbit SIMMs in Banks A and B
- >8 MB: see the 32-bit addressing information below

Again, it is important to make sure the right size SIMMs are in the right Bank; when you are using a combination of SIMMs, the larger SIMMs (in terms of Mbits) must typically be in Bank A (see the exception below). When you are using only four SIMMs, they must be in Bank A as well.

32-Bit Addressing With the Macintosh SE/30, II, IIx, and IIcx

The Macintosh SE/30, II, IIx, and IIcx ROMs are not capable of 32-bit addressing. These models can overcome this limitation, however, by using the appropriate system software. A/UX is a 32-bit operating system, as is System 7 when used in conjunction with MODE32 or when used on a Macintosh with 32-bit clean ROMs.

To have more than 8 MB of RAM in a Macintosh II or IIx, special 120 ns PAL SIMMs are required. These SIMMs incorporate PAL logic chips that overcome problems caused by the refresh logic on the Macintosh II and IIx. In addition, a PMMU is required on the Macintosh II. Please refer to the end of this Note ("4 MBit DRAMs in Revolt") for more information on this subject.

Due to an undocumented feature in the ROM firmware shipped with the original Macintosh II, a Macintosh II with original ROMs is limited to using SIMMs no larger than 1 MB in Bank A. Large SIMMs can only be put in Bank B (that is, 4 and 16 MB SIMMs). Remember that if Bank B is to be used at all, Bank A must be populated first. As a result of this limitation, the largest memory configuration on an unmodified Macintosh II using 1 MB SIMMs in Bank A and 4 MB SIMMs in Bank B is 20 MB. This problem is avoided if you've installed the SuperDrive upgrade kit, which includes a set of Macintosh IIx ROMs. The Macintosh IIx ROMs can handle 4 MB SIMMs, and expect the presence of a SWIM chip in place of the old IWM.

The theoretical maximum memory that a Macintosh SE/30, IIfx, IIfx (and II with IIfx ROMs) can address is 128 MB using 16 MB SIMMs.

Please remember that the use of large SIMM sizes with the Macintosh hardware line has not yet been tested thoroughly. It is mentioned here for your consideration and should be considered theoretical until we have been able to further test all of these possible configurations.

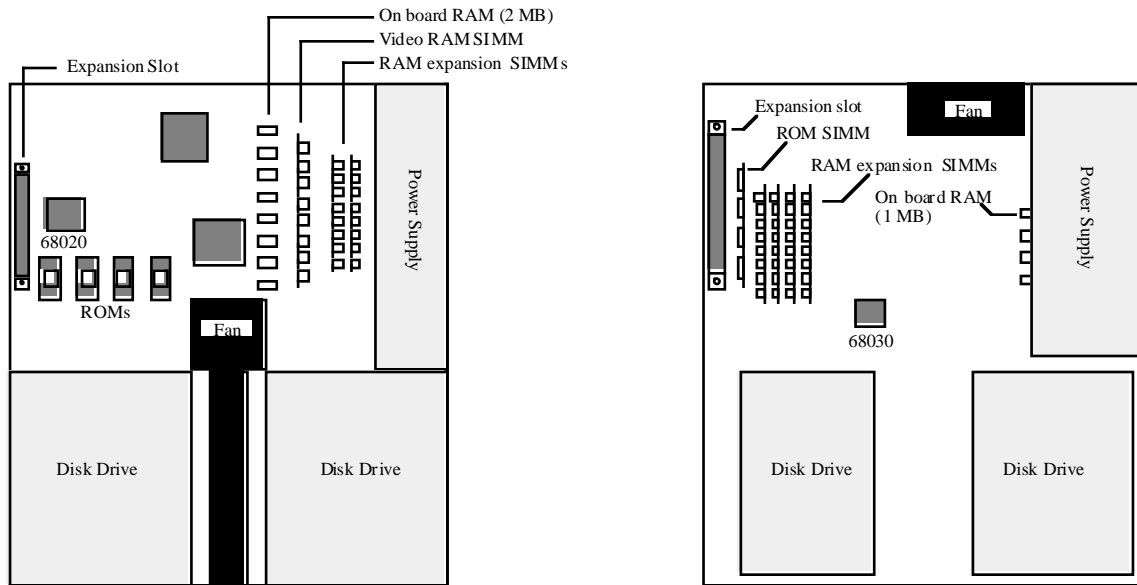

Macintosh LC
(RAM SIMMs must be 100 nS RAS-access time or faster.)

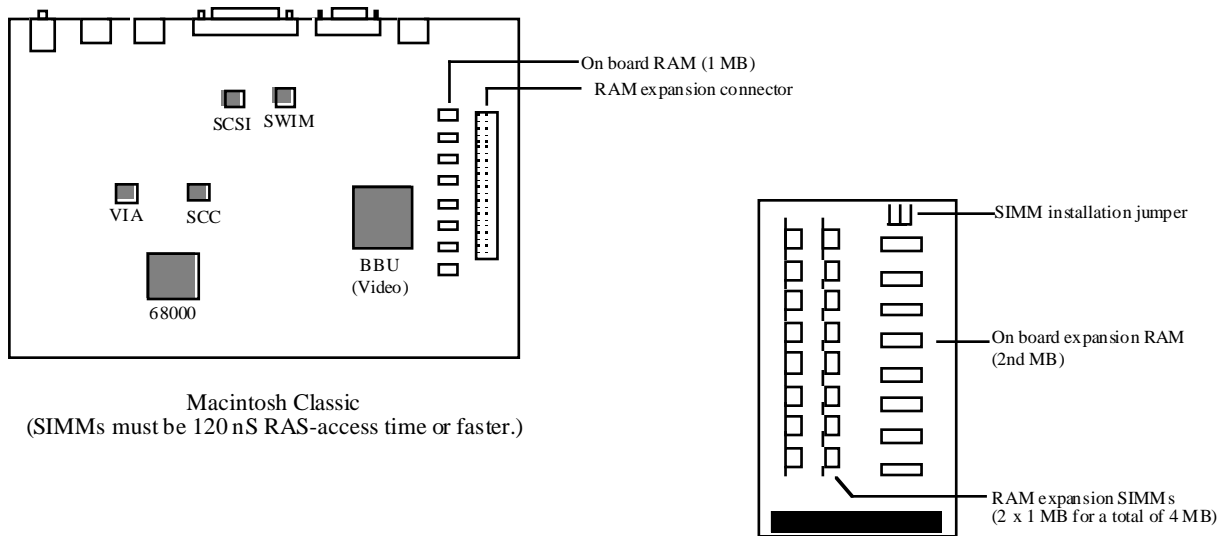

Macintosh Classic RAM expansion board

Figure 4 - Macintosh Classic, LC and IIfx

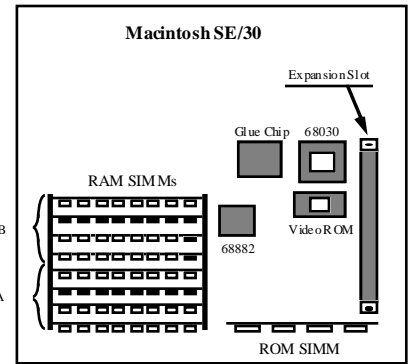
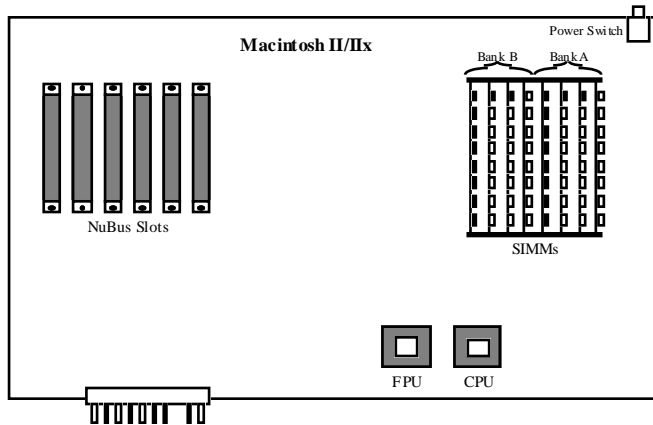

(SIMMs must be 120 nS RAS-access time or faster, and the same speed within a row.)

Macintosh II, IIX, and Macintosh SE/30 memory configurations are identical.

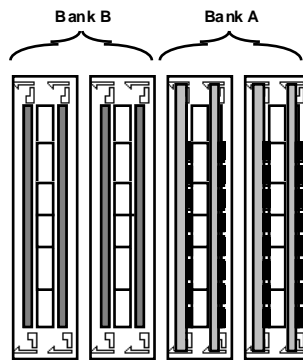

System Memory Size: 1 MB
Bank A: 4 x 256K SIMMs
Bank B: Empty

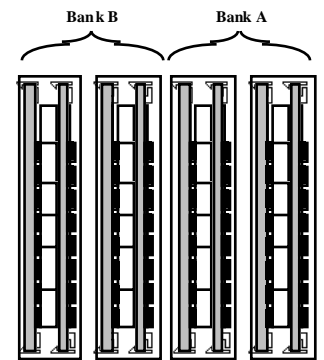

System Memory Size: 2 MB
Bank A: 4 x 256K SIMMs
Bank B: 4 x 256K SIMMs

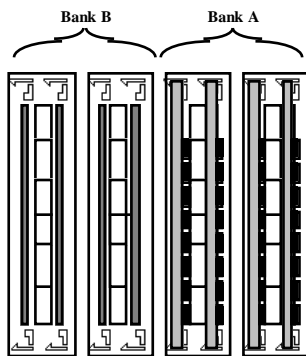

System Memory Size: 4 MB
Bank A: 4 x 1 MB SIMMs
Bank B: Empty

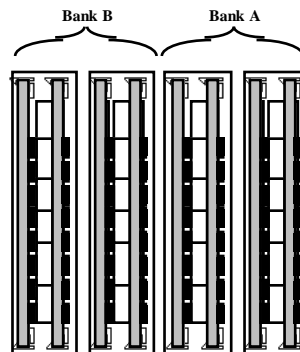

System Memory Size: 5 MB
Bank A: 4 x 1 MB SIMMs
Bank B: 4 x 256K SIMMs

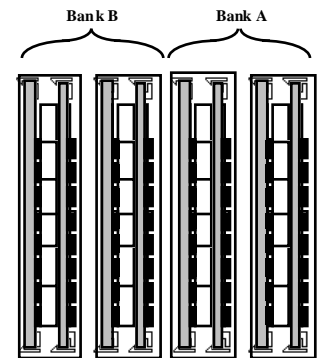

System Memory Size: 8 MB
Bank A: 4 x 1 MB SIMMs
Bank B: 4 x 1 MB SIMMs

Figure 5 - Macintosh SE/30, II, and IIX Memory Configuration

Macintosh LC

The Macintosh LC uses a 16-bit data bus with 8-bit SIMMs, so upgrades must always be performed two SIMMs at a time. The LC has two SIMM connectors that are used as a single additional RAM bank (see Figure 4) in addition to the 2 MB already soldered to the motherboard. The following memory configurations can be implemented by installing SIMM pairs in this additional bank:

- 2 MB, using four 1 Mbit x 4 DRAMs soldered to the motherboard
- 4 MB, using two 1 Mbit SIMMs in the SIMM connectors
- 6 MB, using two 2 Mbit SIMMs in the SIMM connectors
- 10 MB, using two 4 Mbit SIMMs in the SIMM connectors

The Macintosh LC requires 100 ns or faster SIMMs.

Macintosh IIsi

The Macintosh IIsi is similar to the SE/30, II, IIX, and IICX in that it uses a 32-bit data bus with 8-bit SIMMs; you must always upgrade memory in four SIMM chunks. The IIsi differs in that it only has one SIMM bank instead of two (see Figure 4).

If future 16 Mbit DRAMs are compatible with the current refresh frequency, then the IIsi will support 16 Mbit SIMMs, enabling a RAM configuration of 65 MB (4 x 16 MB + 1 MB). The IIsi requires 100 ns or faster SIMMs.

Macintosh IICI

The Macintosh IICI motherboard layout is somewhat different from the IICX, but the location of the RAM SIMMs is unchanged. Bank A is still the bank closest to the disk drives. Refer to Figure 6 for the proper locations of Banks A and B on the IICI.

The IICI has a much improved RAM interface and allows a great deal more freedom when installing SIMMs. Banks A and B are interchangeable, meaning that when mixing two sizes of RAM, the larger SIMMs do not necessarily have to go in Bank A. In fact, for best performance when using on-board video, Apple recommends that the smaller SIMMs be installed in Bank A. Note, however, that if on-board video is used, then RAM **must** be present in Bank A.

The IICI **requires** that SIMMs be 80 ns time or faster and the same speed within a row. You can implement the following memory configurations with 256K and 1 MB SIMMs:

- 1 MB using four 256 Kbit SIMMs in Bank A or in Bank B
- 2 MB using eight 256 Kbit SIMMs in Banks A and B
- 4 MB using four 1 Mbit SIMMs in Bank A or in Bank B
- 5 MB using four 256 Kbit SIMMs in Bank A and four 1 Mbit SIMMs in Bank B
- 5 MB using four 1 Mbit SIMMs in Bank A and four 256 Kbit SIMMs in Bank A
- 8 MB using eight 1 Mbit SIMMs in Banks A and B

The 1 MB and 4 MB configurations using only Bank B are not compatible with on-board video, since Bank A must contain memory when using on-board video. The first 5 MB

configuration (with 256 Kbit SIMMs in Bank A) is recommended for 5 MB configurations using on-board video.

Parity RAM

Some specially ordered versions of the Macintosh IIfx are equipped with a PGC chip and support parity for RAM error detection. These machines require parity RAM. SIMMs for these machines are nine bits wide instead of eight, so there is generally an extra RAM IC on the SIMM. There is no difference in the installation of 256K x 9 or 1M x 9 SIMMs.

Macintosh Portable

Memory expansion on the Macintosh Portable is different from other members of the Macintosh family since the Portable uses memory expansion cards in place of SIMMs. The base Portable is equipped with 1 MB of RAM on the motherboard and has one RAM expansion card slot. Apple currently supplies a 1 MB memory expansion kit that takes the Portable to 2 MB total. Apple and third-party developers may produce higher-capacity expansion boards (2 MB to 8 MB) in the future.

Since the Portable has only one RAM expansion slot, you may use only one memory expansion board at a time. This limit means that a 1 MB expansion board would have to be completely replaced by a higher-capacity board when it became available.

Total RAM for the Portable will always be 1 MB plus the size of your one RAM expansion board (if installed). Refer to Figure 6 for the location of the RAM expansion slot.

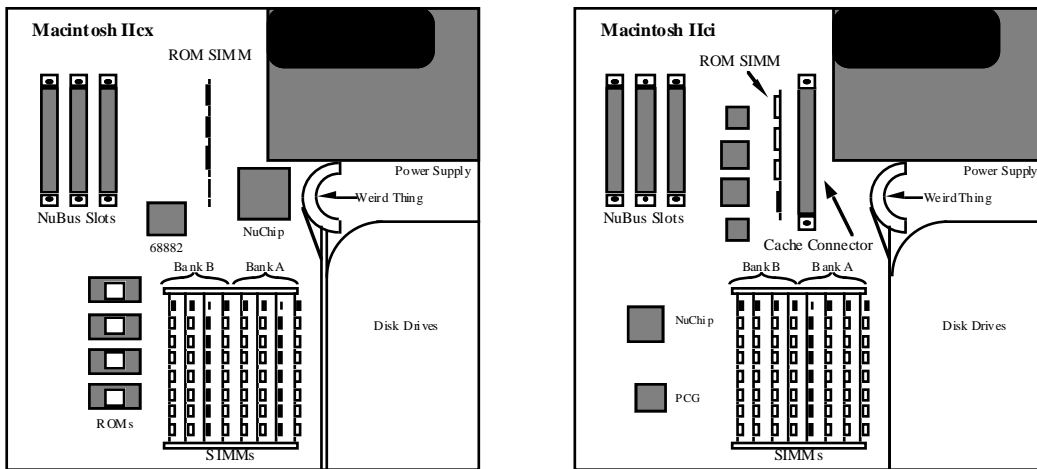

(SIMMs must be 80 nS RAS-access time or faster, and the same speed within a row.)

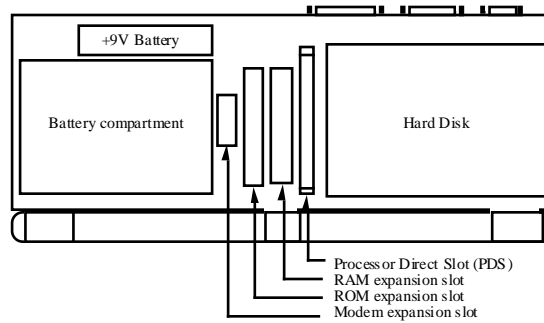

Figure 6 - Macintosh IIcx, IIci, and Portable Memory Configurations

Macintosh IIfx

The Macintosh IIfx motherboard layout has its SIMMs located in the same general area as the IIX, but they are oriented transversely. Bank A is the bank closest to the rear of the machine; bank B is closest to the main processor. Refer to Figure 7 for the proper memory bank locations.

The IIfx has a RAM SIMM interface similar to that of the IICx, et al.: when you are using a combination of SIMMs, the larger SIMMs (in terms of Mbits) must be in Bank A. When you are using only four SIMMs, they must be in Bank A as well. The description in the *Guide to the Macintosh Family Hardware*, Second Edition inaccurately states the larger SIMMs can be placed in either bank.

The IIfx **requires** that SIMMs be 80 ns RAS-access time or faster and the same speed within a row. You can implement the following memory configurations with 1 and 4 MB SIMMs (256K address-depth SIMMs are not supported):

- 4 MB using four 1 Mbit SIMMs in Bank A
- 8 MB using eight 1 Mbit SIMMs in Banks A and B
- 16 MB using four 4 Mbit SIMMs in Bank A
- 20 MB using four 4 Mbit SIMMs in Banks A and four 1 Mbit SIMMs in Bank B
- 32 MB using eight 4 Mbit SIMMs in Banks A and B

Parity RAM

Parity RAM requirements are as follows: if using 1 MB or 4 MB SIMMs, the RAM speed must be 60 ns. However, the parity circuit programmable array that goes on the motherboard as well as the parity PALs that go on the SIMMs are proprietary to Apple—their equations are not expected to be released to developers. Because of this proprietary design, Apple does not recommend third-party development of parity products.

RAM SIMM Drawings

The IIfx has 64-pin SIMMs, which are different from previous Macintosh models. Developers can request mechanical drawings and electrical specifications of the IIfx RAM SIMM modules from DTS. Please send the request with a mailing address and include the words “IIfx SIMM information request” in the title of the electronic mail request or letter to facilitate handling.

Warning: To avoid degradation of signal quality, it is critical to adhere to the strict timing parameters of the IIfx and to use a good layout that takes high-speed circuits into account.

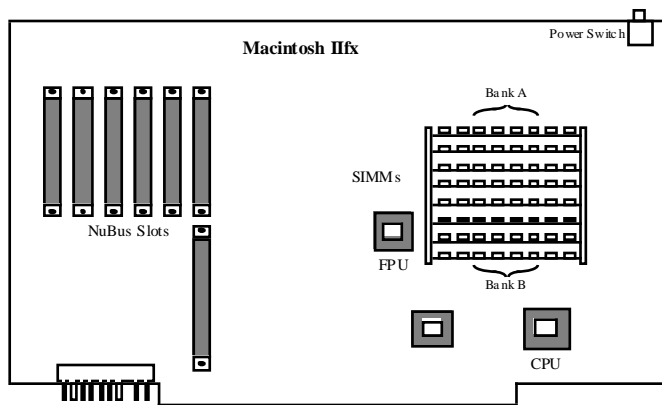

(SIMMs must be 80 nS RAS-access time or faster, and the same speed within a row).



System Memory Size: 4 MB
Bank A: 4 x 1 MB SIMMs
Bank B: Empty



System Memory Size: 8 MB
Bank A: 4 x 1 MB SIMMs
Bank B: 4 x 1 MB SIMMs

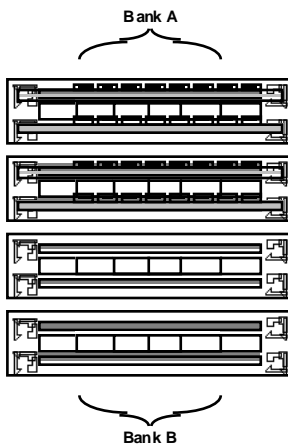

System Memory Size: 16 MB
Bank A: 4 x 1 MB SIMMs
Bank B: Empty



System Memory Size: 20 MB
Bank A: 4 x 4 MB SIMMs
Bank B: 4 x 1 MB SIMMs



System Memory Size: 32 MB
Bank A: 4 x 4 MB SIMMs
Bank B: 4 x 4 MB SIMMs

Figure 7 - Macintosh IIx Memory Configurations

Macintosh Quadra 900

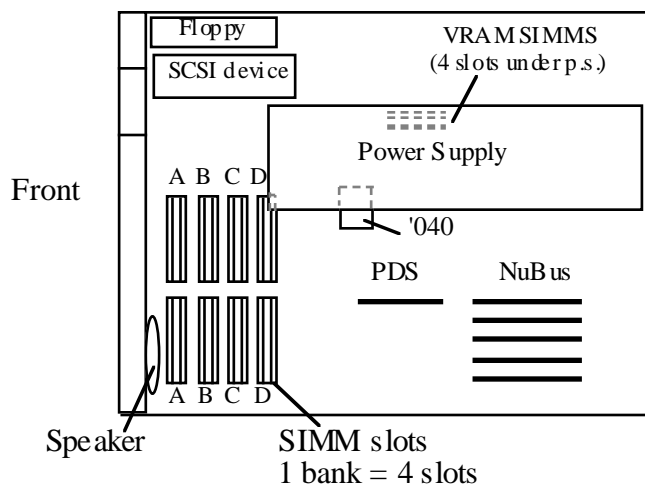

Figure 8 - View of the Macintosh Quadra 900 With Case Open

The memory control unit (MCU) controls four banks of dynamic RAM, for a total of 16 SIMM slots. Each bank accepts standard 80 ns SIMMs containing 1 MB, 4 MB, and perhaps 16 MB SIMMs (256K and 2 MB are not supported), giving total memory sizes from 4 MB to 16 MB for each bank (64 MB if 16 MB SIMMs work). Therefore, the Macintosh Quadra 900 could have a total of 64 MB when using currently available 4 MB SIMMs. 16 MB SIMMs have not been thoroughly tested on the Quadra 900 and therefore cannot be listed as a possible configuration. The Macintosh Quadra 900 can also use 60 ns SIMMs, but the MCU is programmed for 80 ns DRAM, so a 60 ns SIMM wouldn't improve the speed.

If one slot in a given bank is filled, then all slots in that particular bank must be populated with the same size SIMM. It is not possible to mix the speed of RAM, even between banks. The order that the banks are populated does not matter (for example, it is acceptable to have four 1 MB SIMMs in Bank B, and four 4 MB SIMMs in Bank D).

Note: When large amounts of DRAM are installed, the memory check upon startup is lengthy and can cause users to think that the machine isn't functioning. There is no software indication that the machine is running memory checks.

Macintosh Quadra 700

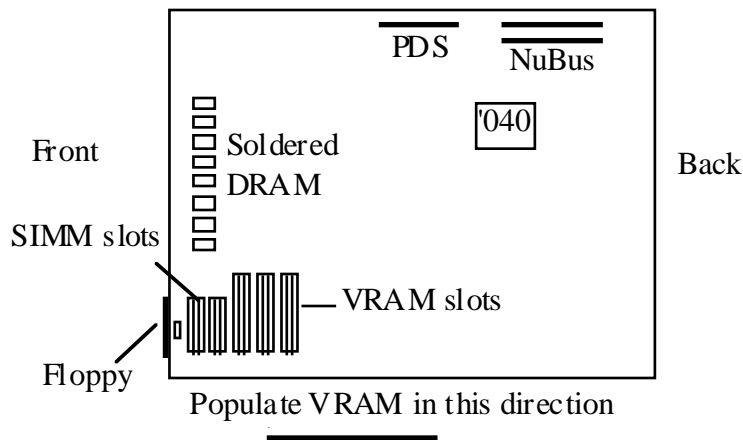

Figure 9 - View of the Macintosh Quadra 700 With Case Open

The memory control unit (MCU) IC controls two banks of dynamic RAM on the Macintosh Quadra 700. The first bank is soldered down at the factory, and fixed at 4 MB. The additional bank accepts standard 80 ns SIMMs containing 1 MB, 4 MB, and perhaps 16 MB (256K and 2 MB are not supported), giving total memory sizes from 4 MB to 16 MB for each bank. Therefore the Macintosh Quadra 700 could have a total of 20 MB when using SIMMs that are currently available. 16 MB SIMMs have not been tested on the Quadra 700 and therefore cannot be listed as a possible configuration. The Macintosh Quadra 700 can also use 60 ns SIMMs, but the MCU is programmed for 80 ns DRAM, so a 60 ns SIMM wouldn't improve the speed. If one slot in a given bank is filled, then all slots in the bank must be populated. It is not possible to mix the speed of RAM SIMMs on the Quadra 700.

Note: Due to the location of the SIMM slots on the Macintosh Quadra 700, it is unlikely that third-party vendors will be able to develop 16 MB SIMMs that work on this machine. The placement of the SIMM slots (under the hard drive) is unfortunate, but necessary due to the logic board real estate.

Macintosh Classic II

The Macintosh Classic II can support up to 10 MB of system RAM. The logic board includes 2 MB soldered and 2 SIMM sockets that can accommodate 1, 2, or 4 MB SIMMs for possible system configurations of 2, 4, 6, or 10 MB. The Classic II requires 100 ns or faster access time for SIMMs to be compatible.

Possible memory configurations:

| Built-in | + | SIMM size | x2 | = | Total RAM (MB) |
|----------|---|-----------|----|---|----------------|
| 2 | | 0 | | | 2 |
| 2 | | 1 | | | 4 |
| 2 | | 2 | | | 6 |
| 2 | | 4 | | | 10 |

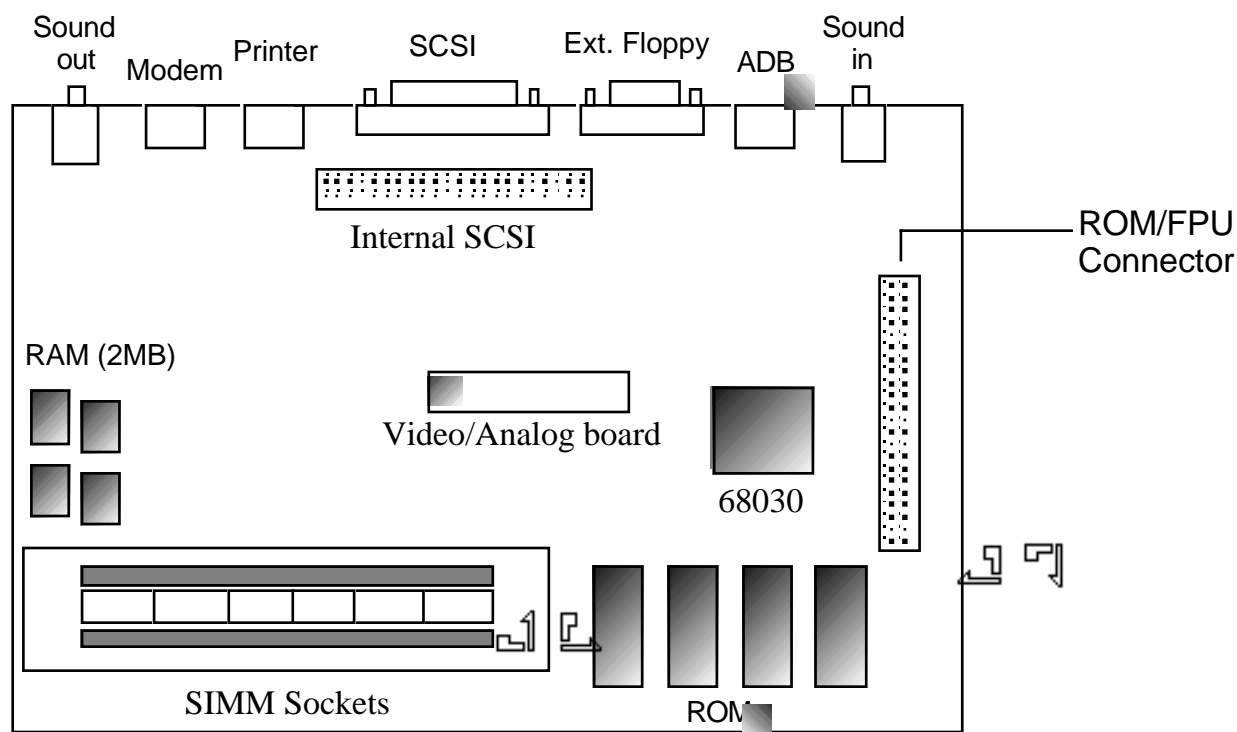

Figure 10 - Macintosh Classic II
(SIMMs must be 100 ns RAS-access time or faster.)

Macintosh PowerBook 140 and Macintosh PowerBook 170

The Macintosh PowerBook 140 and 170 ship with 2 MB of PSRAM (pseudo-static) on the daughter board. The RAM is arranged physically as four 4 Mbit chips of 512K x 8-bits each. Additionally, an expansion slot allows RAM to be expanded to a total of 8 MB. Both notebook systems use 100 ns PSRAM. The Macintosh PowerBook 140 has one wait state (four clock cycles). The Macintosh PowerBook 170 has two wait states (five clock cycles). PSRAM needs to be refreshed, and the refresh is accomplished by circuitry in the CPU Glue Logic ASIC. The refresh requirement causes a 2% reduction in performance over SRAM. However, PSRAM uses less current in sleep mode and costs less than SRAM.

The PowerBook computers contain a 70-pin RAM expansion connector (slot) that supports RAM expansion card sizes of 2, 4, and 6 MB. Apple offers a 2 MB and 4 MB memory card.

Note: If a RAM expansion card is designed correctly, it will work in all of the PowerBook computers. The 68030-based PowerBooks have a 32-bit data bus whereas the 68HC000-based machine (the PowerBook 100) has only a 16-bit data bus. If the expansion card is designed as a 32-bit device it will only work in the PowerBook 140 and 170, but if the data lines and chip select lines are in the correct location on the card, users can use the same card in either machine without loss of performance. The separated chip select lines are necessary for the 68HC000-based machine because it can get access to only 16 bits at a time. The Macintosh PowerBook 140 and 170 do not require separated chip select

lines because both have a 32-bit data bus; therefore the lines are tied back together on the computer's main logic board.

The Apple PowerBook RAM cards will work in all three PowerBook systems. If purchasing RAM from third-party vendors, make sure it will work in the 68HC000-based portable as well.

RAM is always contiguous because only one size of RAM chip (4 Mbits) is used. As a result, the amount of memory the computer has doesn't have to be determined by the software. The RAM array is nominally located in the system memory map between addresses \$0000 0000 and \$0020 0000 (up to \$0080 0000 in an 8 MB system), except following a system reset or sleep cycle, at which time it is overlaid by system ROM. However, the overlay is removed following access to normal ROM space, and the RAM space is then accessible. Both RAM and ROM memory spaces provide DSACK signals to the processor even if memory is not actually installed.

RAM wait states: access to the RAM from the main processor requires 100 ns PSRAM and two processor wait states (five clock cycles per RAM access). The CPU Glue Logic custom chip includes special circuitry that performs the refresh function.

Battery backup: both main and expansion RAM memories are backed up when the computer is in the sleep mode. This means that when the computer is not in use, the contents of the memory array are retained as long as the battery remains charged.

Note: When the battery is removed RAM contents are lost. Unlike the Macintosh PowerBook 100 and Macintosh Portable, when the battery is removed, the contents of RAM are lost. The user must shut down the unit before replacing the battery. The backup battery in the Macintosh PowerBook 140 and 170 computers supply power only to the RTC chip (the clock).

Macintosh PowerBook 100

The system comes with 2 MB of PSRAM (pseudo-static RAM). The RAM is arranged as four 4 Mbit chips of 512 by 8 bits each. The memory chips have an access and cycle time of 100 ns. There are no processor wait states to RAM unless the requested location in the pseudo-static RAM is being refreshed.

The system RAM can be expanded via a new 70-pin RAM expansion connector. The expansion slot can be filled with card sizes of 2 MB, 4 MB, or 6 MB. The system will automatically determine the card's memory size. These memory expansion cards can be used with the Macintosh PowerBook 140 and 170 computers.

System RAM is always powered; therefore RAM disks will be saved even after shutdown (similar to the Macintosh Portable). RAM will be maintained by three lithium batteries during a main battery exchange.

4 Mbit DRAMs in Revolt

When the Macintosh II was originally designed, Apple engineers intended for it to accept large amounts of memory in the form of 4 MB and 16 MB DRAM SIMMs. That was in 1986, when

1 Mbit DRAM was difficult to find and the higher-density chips did not yet exist. The engineers anticipated the pinouts of the yet to be introduced 4 MB SIMMs and provided all the necessary hardware and address multiplexing to allow installation of these parts when they became available.

Woe that Cupertino is not Camelot, James Brown is still on probation, and 4 MB SIMMs do not work as advertised in most cases. This is the story of the Revolt of the 4 MB DRAM SIMMs.

Preliminary Notes

Before diving into the problem with 4 Mbit DRAMs, there is some preliminary ground that must be covered.

First, there are a couple ways to construct a 4 MB SIMM. Using old technology, it is possible to cram together 32 DRAM ICs of 1M x 1 density. Using new technology, it only takes eight 4M x 1 ICs, resulting in a much smaller, lower-power module. If a 4 MB SIMM is of the large, so-called composite type (that is, it is constructed of 32 1 Mbit ICs), then everything is fine except on the original Macintosh II. Please refer to page 7 of this Tech Note for more information on Macintosh II RAM.

With the FDHD SuperDrive upgrade kit installed, the Macintosh II is on equal footing with the Macintosh Iix. That is, SIMMs made exclusively of the new 4 Mbit ICs still won't work, regardless of whether you are using a Macintosh II or Iix; therefore, for the remainder of this discussion, *Macintosh II* is used to refer to not only the original Macintosh II, but also the Iix.

Subsequent Macintosh models have revised ROMs that recognize 4 MB SIMMs.

The 4 Mbit Problem

DRAM ICs are now available in 4 Mbit density, but they come with a very nasty surprise. JEDEC, the committee overseeing the standardization of new solid-state devices, has added an additional built-in test mode to high-density DRAMs. The test mode is invoked by a sequence of electrical signals that was ignored by earlier-generation DRAM. The crux of the situation is this: under certain conditions, the Macintosh II unwittingly activates this new test mode and large amounts of memory become very forgetful.

More Specifically . . .

Those who are interested in the specific phenomenon occurring within the memory ICs should consult the detailed technical data supplied by the DRAM manufacturers. This Note only explains how the Macintosh II offends this new feature of the 4 Mbit DRAM, and hence, what might be done to work around the problem.

The Macintosh II uses /CAS-before-/RAS refresh cycles to keep RAM up to date on its contents. For 1 Mbit DRAM, the state of the /W control line is ignored during this type of refresh cycle. No longer. DRAM of the 4 Mbit variety goes off into test mode if /W is asserted (low, so that the RAM thinks it is write-enabled) during a /CAS-before-/RAS refresh cycle. The problem with the Macintosh II is that /W is the same signal as the MPU R/W line, and if the MPU is writing to an I/O address or a NuBus™ card concurrently with a refresh cycle, all the conditions are right for a waltz into test mode. Unfortunately, this condition is not all that unusual, since video card accesses qualify.

Consolation for SIMM manufacturers: SIMMs constructed with an on-board PAL are not necessarily Macintosh II-specific. SIMMs constructed in this manner should work without modification in any usage calling for 4 MB SIMMs (except in the unlikely event that the new test mode is required).

The Salvage Process

All is not necessarily lost, and although the situation is ugly, there is still a way to use 4 Mbit DRAM ICs to construct 4 MB SIMMs that work in the Macintosh II. A solution lies in the addition of a ninth IC to the SIMM. Programmed with suitable logic, a high-speed (-D or -E suffix) PAL on the SIMM itself can recognize and intercept /CAS-before-/RAS refresh cycles and set /W appropriately before any damage is done. More or less, the PAL becomes an intelligent buffer between the MPU read/write line and the DRAM write-enable lines. When the PAL senses a refresh cycle commencing, it holds /W high, ensuring that the ICs are not corrupted by the potentially dangerous processor-generated R/W signal.

What's the Point?

You have overcome all the problems discussed in this section and have working 4 Mbit SIMMs installed in your Macintosh. You probably have at least 20 MB of RAM. What can you do with all of it? Create lots of huge 32-bit PICTs and edit them all simultaneously? Model and animate Bay Area weather patterns in Mathematica™? Yes! But, you have to use the appropriate system software to address this memory. Also, if you're running in 32-bit addressing mode, the applications that you desire to use need to be 32-bit clean. For more information on 32-bit cleanliness and addressing, please see Technical Notes OV 11 and ME 6.

Under System 7.0, applications can finally access additional physical memory over and above 8 MB. As mentioned previously in this Tech Note, the 32-bit addressing mode of System 7 requires either a Macintosh with 32-bit clean ROMs (listing is on page 2), or else the 32-bit software solution provided by the MODE32 system extension. A/UX is an alternative that can use up to 256K of RAM on Macintosh computers that support A/UX. Many manufacturers of large SIMMs also offer RAM disks. This is a volatile form of storage, but can certainly be useful for I/O intensive operations.

Other Permutations

The problem with 4 Mbit DRAM is not limited to 4 MB SIMMs. It is the 4 Mbit density of the individual RAM ICs that causes problems with certain machines. There exist 1 MB SIMMs constructed of only two 1M x 4 (4 Mbit) ICs. These do not work in a Macintosh II or IIX, any more than 4 MB SIMMs constructed of eight 4M x 1 ICs.

A few machines, namely the Macintosh Plus, Macintosh SE, and Macintosh Classic, depend on video accesses to refresh all of their DRAM. As the video circuitry accesses sequential locations through the video frame buffer, it simultaneously refreshes row after row of memory, eventually refreshing all 512 rows. Memory at the 4 Mbit density, however, is arranged as 1024 rows and there are not sufficient video accesses to refresh all 1024 rows. Chunks of memory simply go blank. Thus for a different reason, 4 Mbit DRAM parts are also not compatible with these older Macintosh hardware designs.

Executive Summary

Owners of the Macintosh Plus, SE, Classic, II, or IIX are all likely to have problems with any 1 MB SIMM carrying only two ICs, or any 4 MB SIMM carrying only 8 ICs. Any SIMM constructed in one of these ways likely uses 4 Mbit density DRAM ICs and does not account for problems with the 4 Mbit test mode nor the video refresh strategy of older Macintosh designs.

Further Reference:

- *Inside Macintosh*, Volume V-1, Compatibility Guidelines
- *Guide to the Macintosh Family Hardware*, Second Edition
- Macintosh IIsi, LC, and Classic Developer Notes
- Macintosh Classic II, Macintosh PowerBook Family, and Macintosh Quadra Family Developer Notes
- Macintosh Technical Notes OV 11 and ME 6

NuBus™ is a trademark of Texas Instruments.

PAL is a trademark of Monolithic Memories, Inc.

Mathematica is a trademark of Wolfram Research, Inc.

MODE32™ is a trademark of Connectix Corporation.