

iMac (USB 2.0)





Basics
iMac (USB 2.0)



Overview

The iMac (USB 2.0) computers are powered by the PowerPC G4 processors. Two models are available: the 17-inch widescreen LCD (1.25 GHz) or the 15-inch LCD flat screen (1 GHz). The computer also includes 80GB hard drives, 256MB DDR333 SDRAM, two FireWire 400 ports and three USB 2.0 ports. The 17-inch widescreen and the 15-inch flat panel computers come with Mac OS X version 10.2.7 installed as the default system.



How to identify these models

Verify the processor speed. If the system is up and running, select “About this Mac” under the Apple icon in the Finder. Or, select the “More Info” button on the “About this Mac” window. Apple System Profiler opens and displays the machine speed under “Hardware Overview.” The 15-inch iMac has a 1GHz PowerPC G4 processor and the 17-inch iMac has a 1.25GHz PowerPC G4 processor.



What's New

New Features

Processor and speed—The microprocessor in the iMac (Flat Panel, USB 2.0) is a PowerPC G4 with a clock speed of 1 GHz in the 15" configuration and a 1.25 GHz in the 17" configuration.

USB 2.0 ports—The computer has three USB 2.0 ports.

Memory— This computer comes with 256 MB of DDR333 SDRAM installed in an internal standard 186-pin DIMM expansion slot, with a build-to-order options of 512 MB. A second user-accessible slot accepts an SO-DIMM with up to 512 MB. The maximum total memory is 1 GB.

System bus— The speed of the system bus is 167 MHz.

Graphics acceleration— The AGP 4X graphics IC used is either an NVidia GeForce4MX or and NVidia GeForce FX5200 Ultra.

Video RAM— The video hardware includes either 32 MB or 64 MB of DDR SDRAM, which supports 3D features and millions of colors in all resolutions.

External video monitor— The external display connector supports mini-VGA, composite, S-video monitors and projectors, and television sets. A video adapter with composite and S-video connectors and a VGA-out adapter are available separately.

Bluetooth support (optional)— Bluetooth support is available as a build-to-order option to enable short-range wireless connections between desktop and laptop computers and a host of other peripheral devices.

Standard Configurations

| Features | 15-inch | 17-inch |
|-------------------------------------|--|--|
| CPU and speed | 1GHz PowerPC G4 | 1.25GHz PowerPC G4 |
| System bus speed | 167 MHz | 167 MHz |
| Main memory | 256 MB SDRAM, expandable up to 1 GB | 256 MB SDRAM, expandable up to 1 GB |
| Display | 15-inch flat panel | 17-inch, wide-screen flat panel |
| Graphics IC | NVIDIA GeForceMX | NVIDIA GeForce FX 5200 Ultra |
| Graphics memory | 32 MB DDR RAM | 64 MB DDR RAM |
| Hard disk drive | 80 GB Ultra ATA-66 7200 rpm | 80 GB Ultra ATA-66 7200 rpm |
| Optical drive | Tray-load Combo drive | Tray-load SuperDrive |
| External monitor adapter | Mini-VGA or S-video/ composite | Mini-VGA or S-video/ composite |
| Communication fea- tures | 10/100 Ethernet; 56K V.92 fax modem | 10/100 Ethernet; 56K V.92 fax modem |
| Wireless features | Optional 54 Mbps AirPort Extreme Card; optional internal Bluetooth | Optional 54 Mbps AirPort Extreme Card; optional internal Bluetooth |



Serial Number Location

To identify a particular model of iMac (USB 2.0), check the computer's serial number, which lists the model's configuration. The serial number is located on the bottom of the computer, on the metal access plate, or on the inside of the optical drive door (bottom photo).





Take Apart
iMac (USB 2.0)





General Information

Overview

The Take Apart chapter includes take apart procedures for both the 15" and 17" iMac (USB 2.0) computers. If you are familiar with taking apart iMac (Flat Panel) computers, you will find that the procedures for these newer models haven't changed. The changes consist of faster processors, faster system bus, larger capacity hard drives, and three USB 2.0 ports.

New Procedures

The following Take Apart sections were updated:

- Display, Inverter, Back Cover, and the Neck Assembly

Tools

The following tools are recommended for the take apart procedures.

- The service stand (076-0898)
- Thermal paste (922-4757)
- Torque driver, 17" LB (076-0899)
- 1.5 mm hex driver (for LCD bezel screws)
- #0 Phillips screwdriver)
- Torx screwdriver set (6, 8, 10, 15)
- Plastic flatblade screwdriver or stylus (922-5065)
- Needlenose pliers
- ESD wriststrap and mat

Service Stand

1. Support the computer by neck and the base (A). Gently position the computer in the service stand with the flat panel facing up (B).



2. **Note:** The base of the computer can be rotated when servicing internal parts.

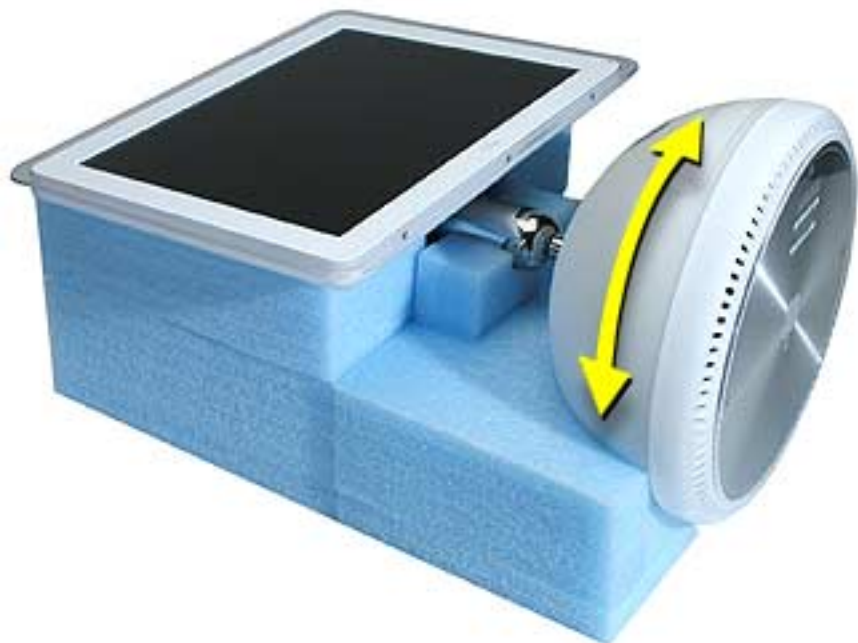



User Access Plate

Tools

This procedure requires the following tools:

- Phillips #0 screwdriver

Part Location



Preliminary Steps

Before you begin, do the following:

- Position the computer in the service stand.

Procedure

1. Loosen the four captive screws on the access panel.
2. Remove the panel by grabbing onto two captive screws and lift the panel off the base.





AirPort Extreme Card

Tools

This procedure requires no tools.

Part Location

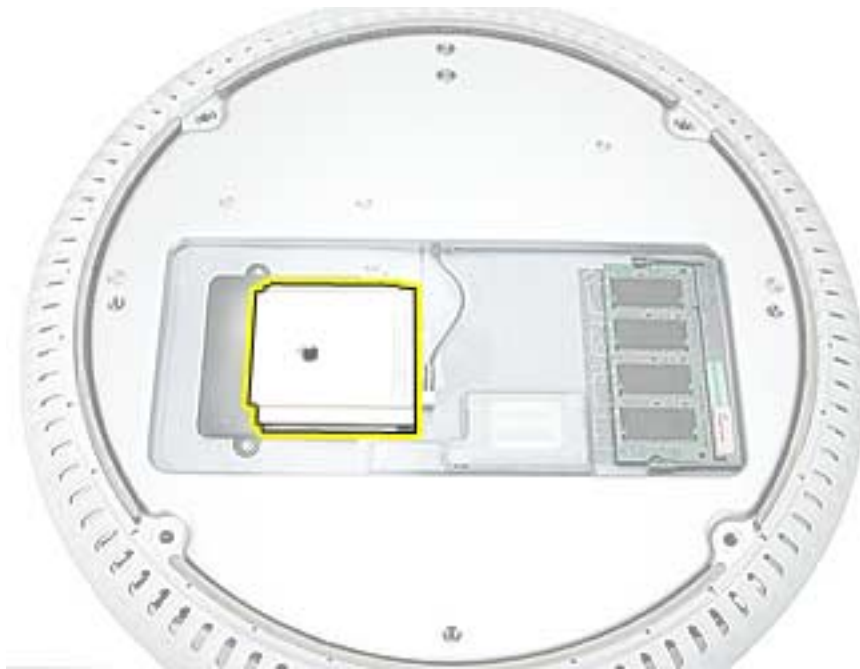

Preliminary Steps

Before you begin, do the following:

- Position the computer in the service stand.
- Remove the user access plate.

Procedure

1. Unplug all cables from the computer **except** the power cord.
2. **Important:** To avoid electrostatic discharge, always ground yourself by touching metal before you touch any parts or install any components inside the computer. To avoid static electricity building back up in your body, do not walk around the room until you have completed the installation and closed the computer.
3. Touch a metal surface inside the computer to ground yourself.



4. Unplug the power cord.
5. Pull the plastic tab on the AirPort Extreme card to remove it from the slot. Disconnect the AirPort antenna from the card.





Memory, SO-DIMM (user-installable)

Tools

No tools are required for this procedure.

Part Location



Preliminary Steps

Before you begin, do the following:

- Position the computer in the service stand.
- Remove the user access plate.

Note: DIMMs used in this slot should be a low-profile PC2700 (DDR333) SO-DIMM. Only the SO-DIMM slot is accessible by the user.

Procedure

1. Unplug all cables from the computer except the power cord.
2. **Important:** To avoid electrostatic discharge, always ground yourself by touching metal before you touch any parts or install any components inside the computer. To avoid static electricity building back up in your body, do not walk around the room until you have completed the installation and closed the computer.
3. Touch a metal surface inside the computer to ground yourself.



4. Unplug the power cord.
5. Release the memory by spreading apart the tabs in the expansion slot from the notches in the card.

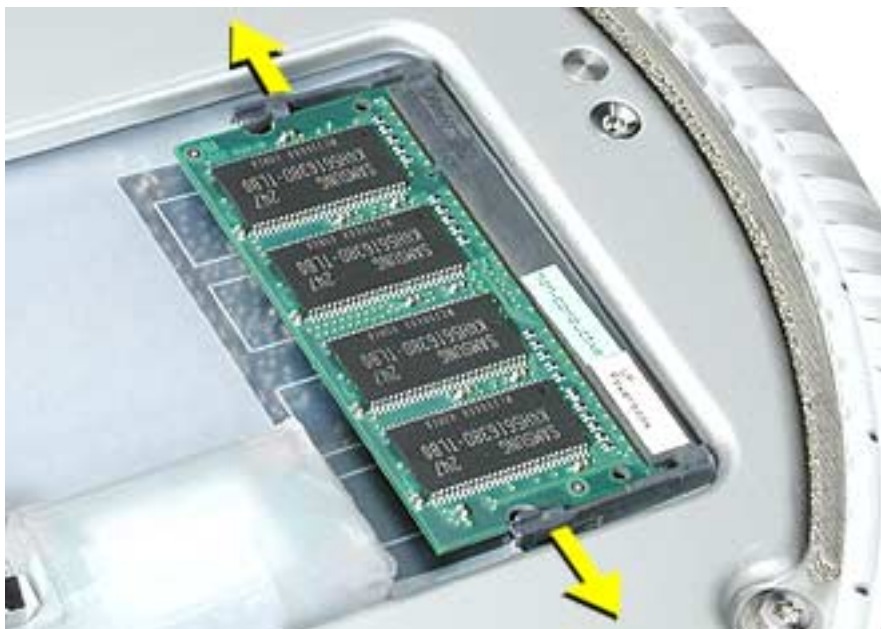

6. Allow the memory to pop up slightly, and pull it out of the memory slot.





Bottom Housing

Tools

This procedure requires the following tools:

- Torx-15 screwdriver

Part Location



Preliminary Steps

Before you begin, do the following:

- Position the computer in the service stand.
- Remove the user access plate.

Procedure

1. When opening the bottom housing, rotate the base so the optical drive door is on the right. (This position is less stressful on the internal cables when the bottom is open).
2. Remove the four torx screws.



Replacement Note: These torx screws must be tightened to at least 17 in.-lbs. If you do not have a torque driver, you will have to make sure these screws are tightened by hand **FIRMLY, BUT NOT FORCIBLY**. Or, purchase the service tool (076-0899) in order to ensure the thermal pipe is firmly mated with the top base. If the bottom housing is not securely attached to the base in this fashion, the CPU may overheat and become damaged. For more information, refer to “Thermal Paste Application” in this chapter. Rotate the base so that the optical drive door is on the right.

-
3. Gently open the bottom housing in the direction of the arrow. Disconnect the cables.

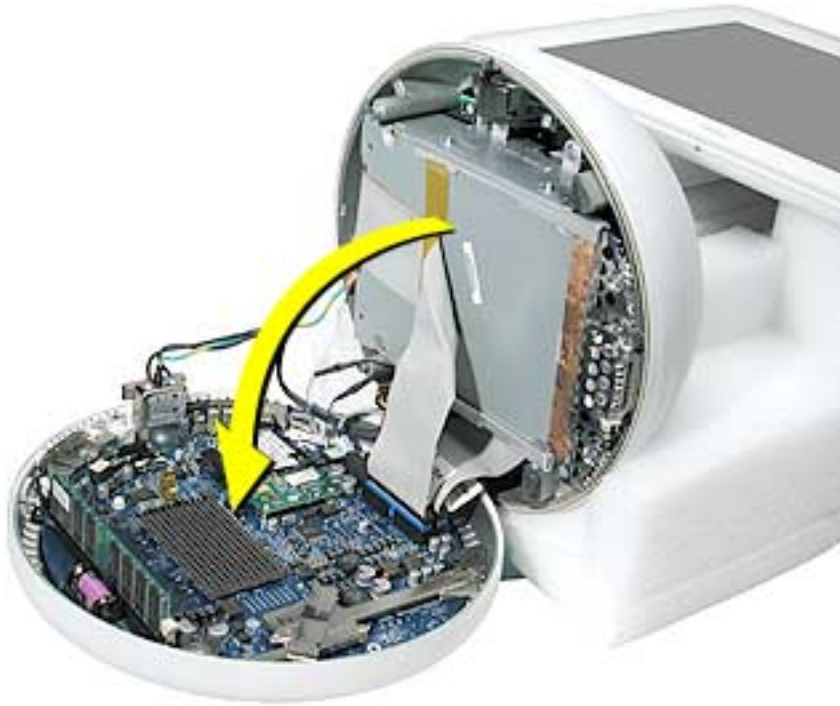

4. Disconnect the following:
 - A Grounding screw
 - B Bluetooth connector (if Bluetooth board is present, this will be connected)
 - C AirPort connector
 - D AC line filter connector
 - E TMDS video connector
 - F Inverter, speaker, fan connector
 - G Optical cable and connector
 - H Hard drive cable and connector
 - I Power Supply connector

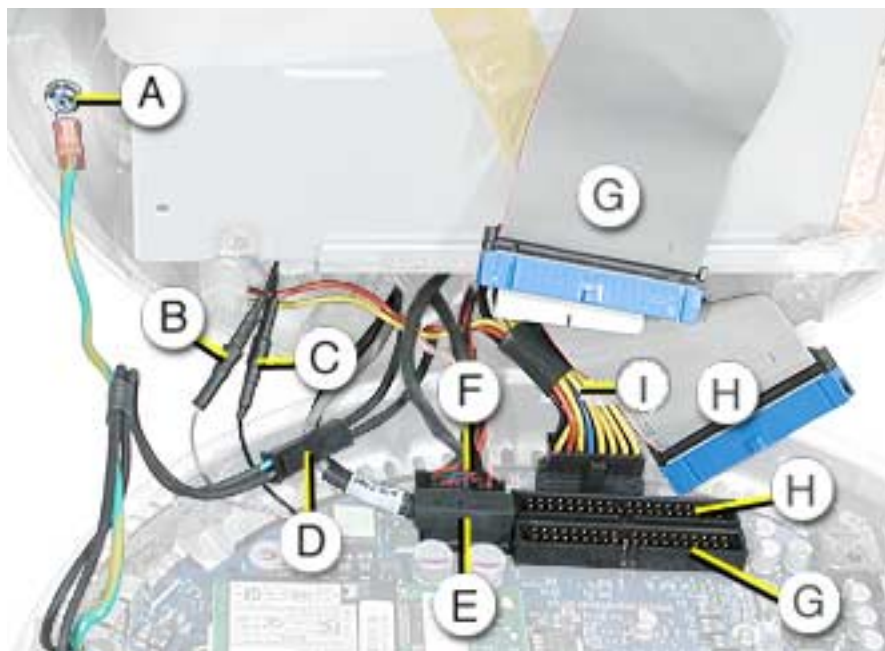

5. Set the bottom housing aside.

Warning: Whenever the bottom housing is opened for service, you must do two things:

1. You must clean the original thermal film from all thermal interface mating surfaces, and reapply thermal paste to the mating surfaces on the thermal pipe.
2. You must tighten the four torx screws on the bottom housing to a minimum of 17 in.-lbs. Use a torque driver (service tool 076-0899) to ensure that the thermal pipe is firmly mated with the top base. If you do not have a torque driver, you must make sure the screws are tightened by hand **FIRMLY, BUT NOT FORCIBLY.**

Failure to follow these steps could cause the computer to overheat and damage internal components.

Refer to the topic “Thermal Paste Application” for detailed information.



Thermal Paste Application

Tools

This procedure requires the following tools:

- Plastic stylus or plastic spatula to remove the old thermal paste
- Plastic stylus or plastic spatula to spread the thermal paste
- Thermal paste (922-4757)

Part Location

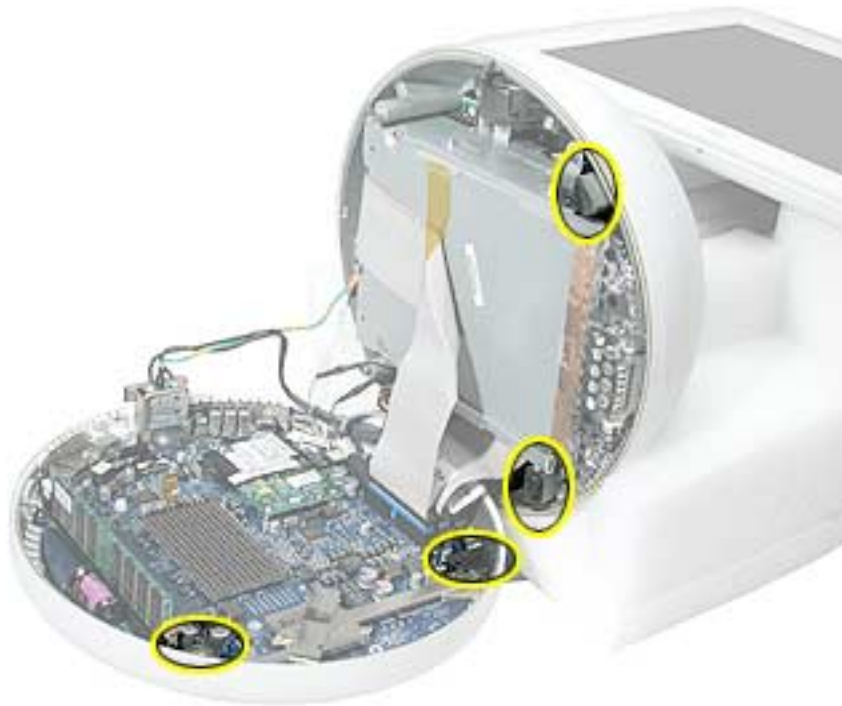

Procedure

1. Thoroughly clean the original thermal film from the mating surfaces (circled below) of the bottom housing and thermal pipe. Use a plastic stylus to scrape the surfaces clean. **Note:** Do not use an abrasive material or liquid cleaner.

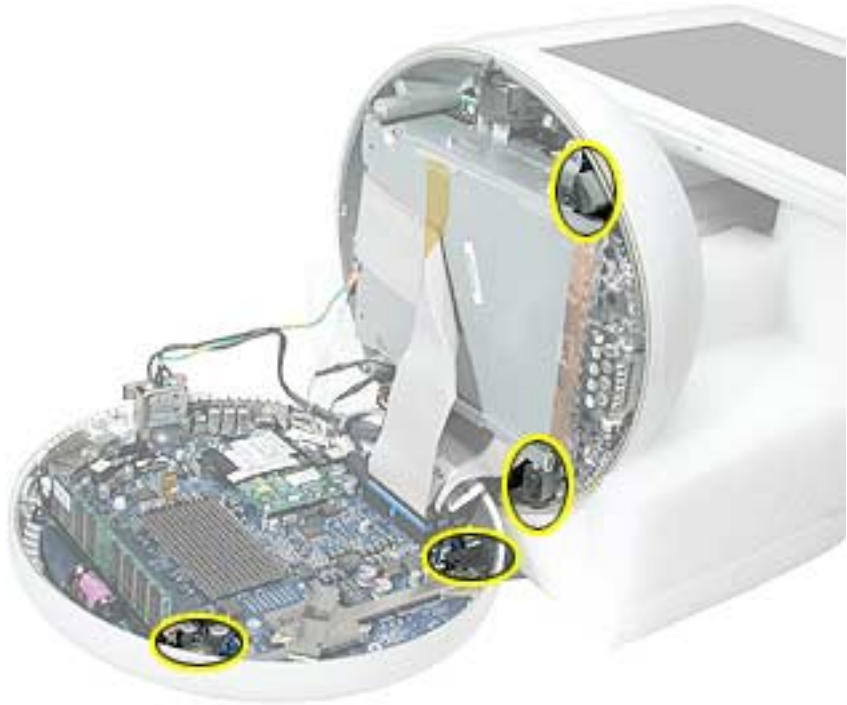

2. Squeeze a ball of thermal paste onto the mating surfaces of the thermal pipe.

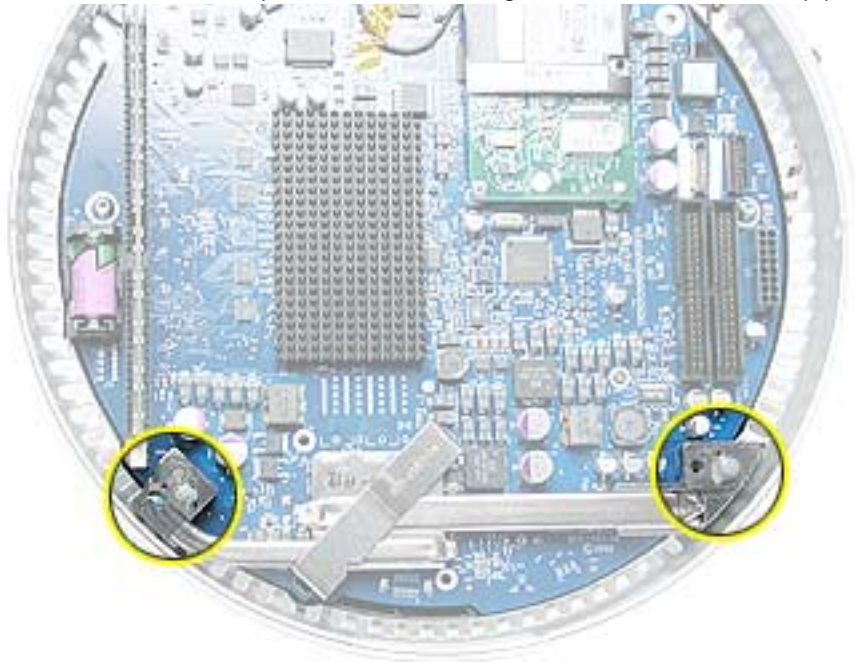

-
3. Replace the bottom housing.

Warning: The bottom housing has four torx screws that must be tightened to at least 17 in.-lbs. Use a torque driver (service tool 076-0899) to ensure that the thermal pipe is firmly mated with the top base. If you do not have a torque driver, you must make sure the screws are tightened by hand **FIRMLY, BUT NOT FORCIBLY**.

Failure to apply the thermal paste as described in this procedure, and failure to tighten the torx screws as directed, could cause the computer to overheat and damage internal components.

Refer to the topic "Thermal Paste Application" for detailed information.



RJ-11 Modem Filter Board

Tools

This procedure requires the following tools:

- Torx-6 screwdriver

Part Location

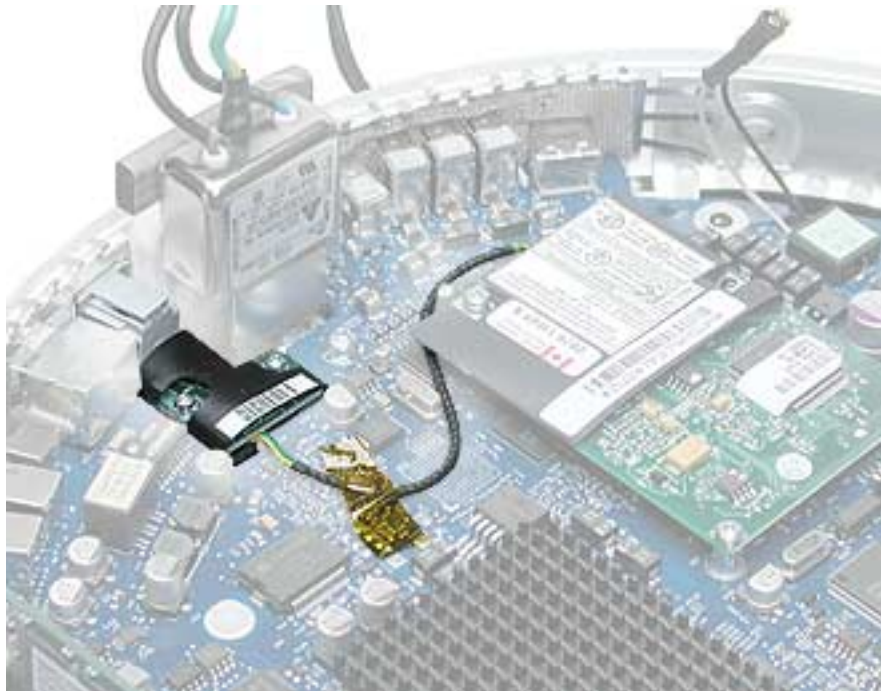

Preliminary Steps

Before you begin, do the following:

- Position the computer in the service stand.
- Remove the user access plate.
- Remove the bottom housing.

Procedure

1. Remove two screws and disconnect the cable from the modem.

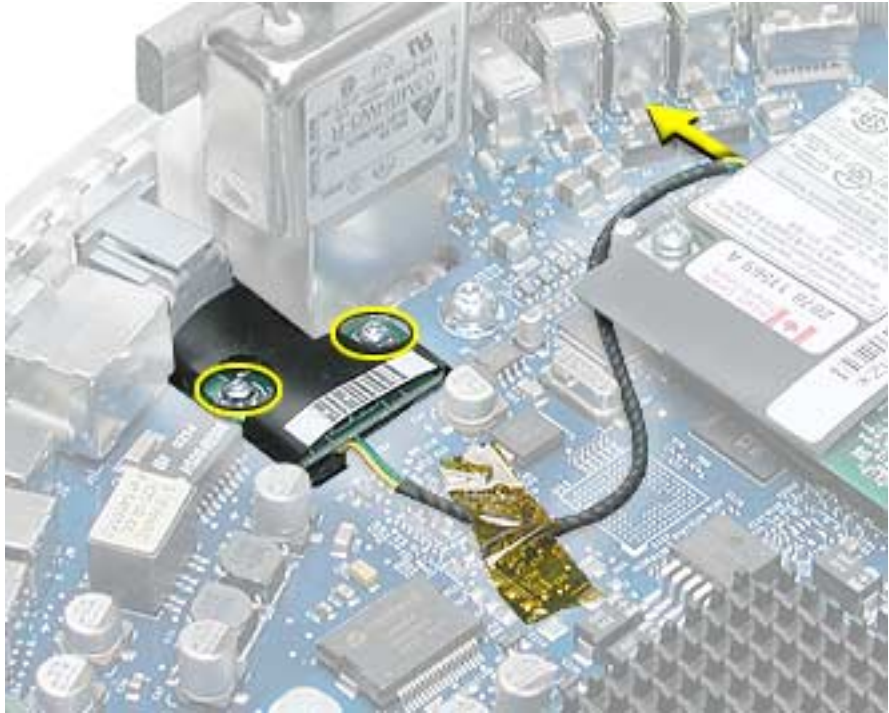

2. Remove the RJ-11 board from the I/O port.

Warning: Whenever the bottom housing is opened for service, you must do two things:

1. You must clean the original thermal film from all thermal interface mating surfaces, and reapply thermal paste to the mating surfaces on the thermal pipe.
2. You must tighten the four torx screws on the bottom housing to a minimum of 17 in.-lbs. Use a torque driver (service tool 076-0899) to ensure that the thermal pipe is firmly mated with the top base. If you do not have a torque driver, you must make sure the screws are tightened by hand **FIRMLY, BUT NOT FORCIBLY**.

Failure to follow these steps could cause the computer to overheat and damage internal components.

Refer to the topic “Thermal Paste Application” for detailed information.



Modem

Tools

This procedure requires the following tools:

- Torx-8 screwdriver

Part Location

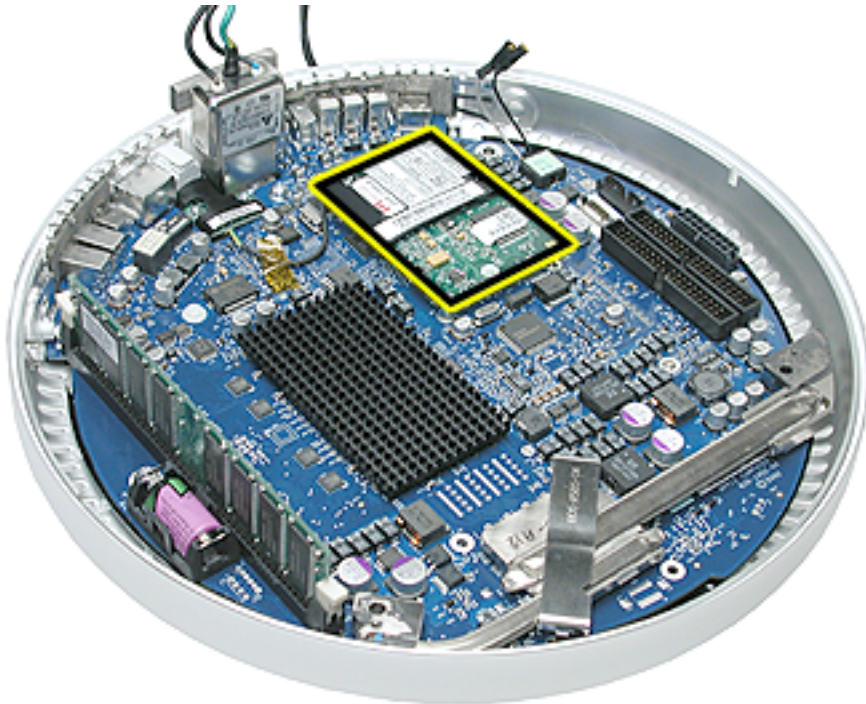

Preliminary Steps

Before you begin, do the following:

- Position the computer in the service stand.
- Remove the user access plate.
- Remove the bottom housing.

Procedure

1. Remove two screws and disconnect the cable.



2. Lift the modem board from the connector on the logic board.

Warning: Whenever the bottom housing is opened for service, you must do two things:

1. You must clean the original thermal film from all thermal interface mating surfaces, and reapply thermal paste to the mating surfaces on the thermal pipe.
2. You must tighten the four torx screws on the bottom housing to a minimum of 17 in.-lbs. Use a torque driver (service tool 076-0899) to ensure that the thermal pipe is firmly mated with the top base. If you do not have a torque driver, you must make sure the screws are tightened by hand **FIRMLY, BUT NOT FORCIBLY**.

Failure to follow these steps could cause the computer to overheat and damage internal components.

Refer to the topic "Thermal Paste Application" for detailed information.



Memory (factory-installed)

Tools

This procedure requires the following tools:

- No tools are required

Part Location

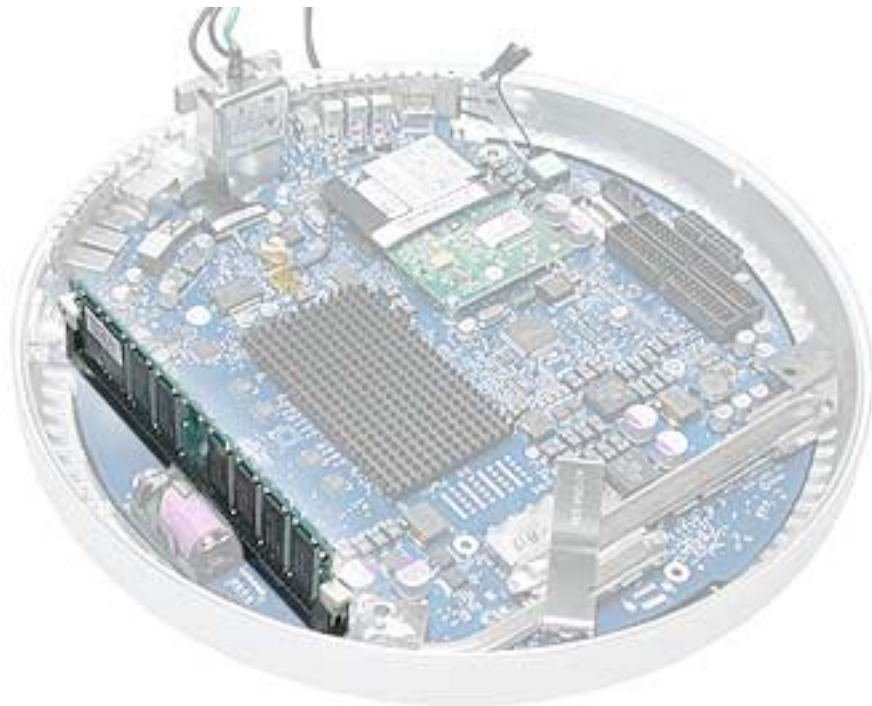

Preliminary Steps

Before you begin, do the following:

- Position the computer in the service stand.
- Remove the user access plate.
- Remove the bottom housing.

Procedure

1. Push down on the ejector tabs to release the memory module.
2. Pull the memory up and out of the slot. **Important:** Make sure that the memory installed on the logic board is compatible with the system. The computer accepts double-data rate (DDR) SDRAM DIMMs. DIMMs used in this slot must fit the following specification: PC2700 SDRAM DDR333 DIMMs for 167 MHz systems.

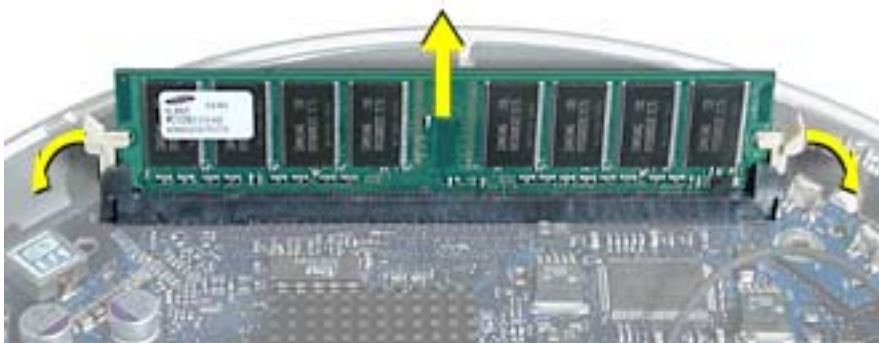

Warning: Whenever the bottom housing is opened for service, you must do two things:

1. You must clean the original thermal film from all thermal interface mating surfaces, and reapply thermal paste to the mating surfaces on the thermal pipe.
2. You must tighten the four torx screws on the bottom housing to a minimum of 17 in.-lbs. Use a torque driver (service tool 076-0899) to ensure that the thermal pipe is firmly mated with the top base. If you do not have a torque driver, you must make sure the screws are tightened by hand **FIRMLY, BUT NOT FORCIBLY.**

Failure to follow these steps could cause the computer to overheat and damage internal components.

Refer to the topic “Thermal Paste Application” for detailed information.



Battery

Tools

This procedure requires the following tools:

- No tools are required

Part Location

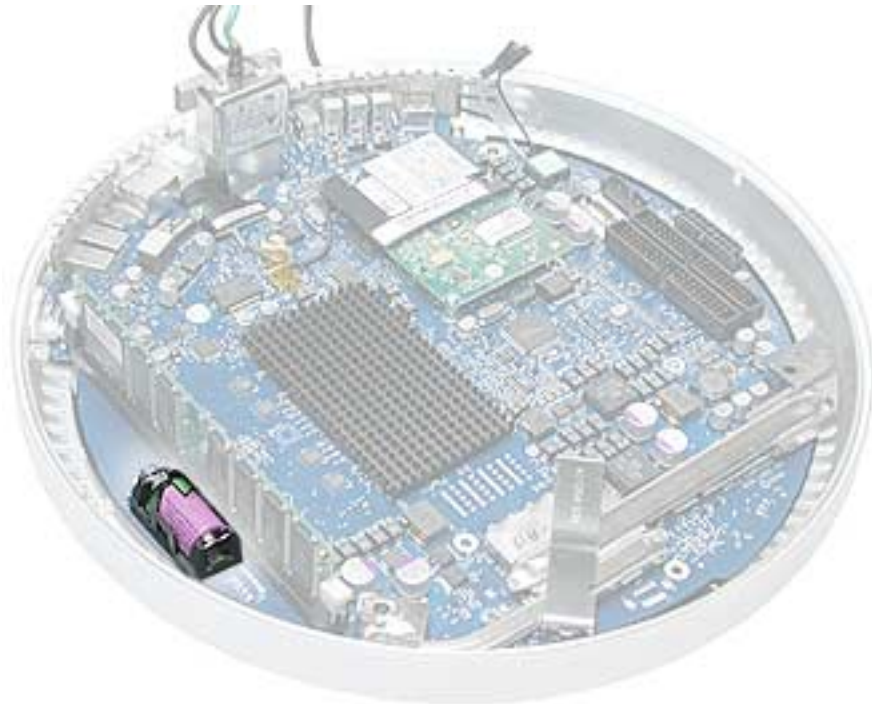

Preliminary Steps

Before you begin, do the following:

- Position the computer in the service stand.
- Remove the user access plate.
- Remove the bottom housing.

Procedure

1. Using a flatblade screwdriver, gently pry the battery from the battery holder.

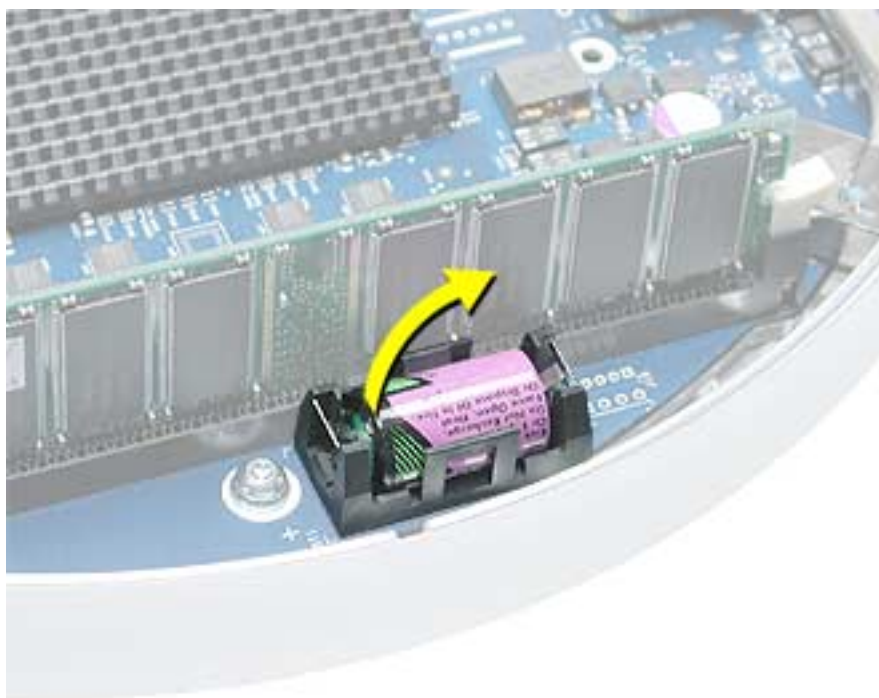

Warning: Whenever the bottom housing is opened for service, you must do two things:

1. You must clean the original thermal film from all thermal interface mating surfaces, and reapply thermal paste to the mating surfaces on the thermal pipe.
2. You must tighten the four torx screws on the bottom housing to a minimum of 17 in.-lbs. Use a torque driver (service tool 076-0899) to ensure that the thermal pipe is firmly mated with the top base. If you do not have a torque driver, you must make sure the screws are tightened by hand **FIRMLY, BUT NOT FORCIBLY**.

Failure to follow these steps could cause the computer to overheat and damage internal components.

Refer to the topic “Thermal Paste Application” for detailed information.



Logic Board

Tools

This procedure requires the following tools:

- Phillips #2 screwdriver (for the plastic screw)
- Torx-15 screwdriver

Part Location

Note: The battery, RJ-11 board, AirPort Extreme card, modem, I/O port covers, memory (on the top and the bottom of the logic board), Bluetooth board and the Bluetooth extension cable need to be removed from the logic board before returning the board to Apple for service.

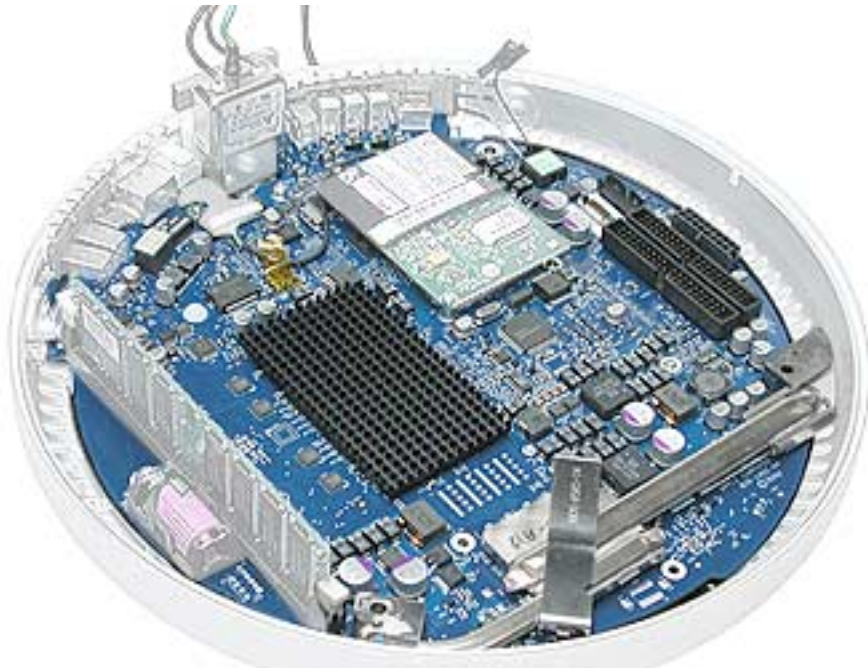

Preliminary Steps

Before you begin, do the following:

- Position the computer in the service stand.
- Remove the user access plate.
- Remove the bottom housing.
- Remove the RJ-11 board.

Procedure

1. Remove the three torx screws (metal) and one plastic screw.

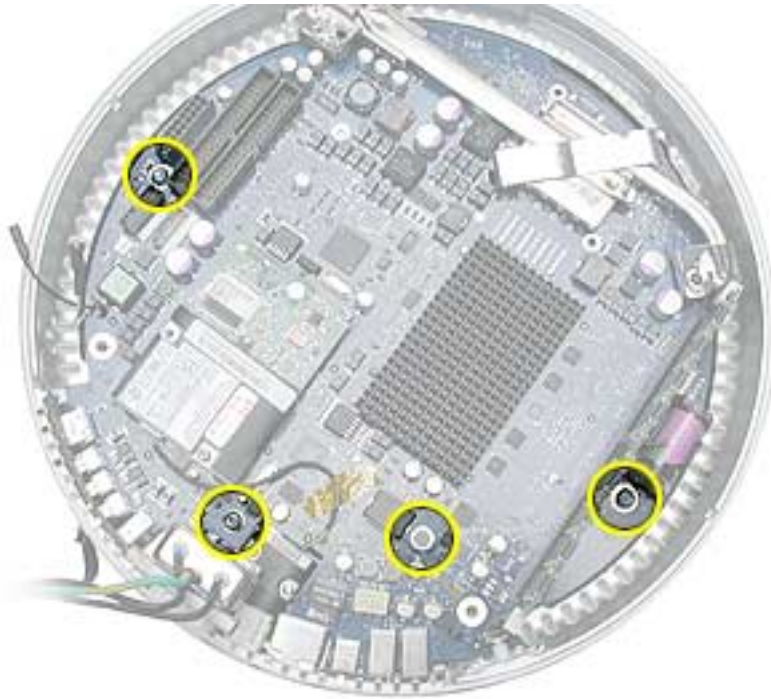

- Grab the logic board by the battery retainer and the hard drive connector. Lift the board slightly and pull back to release the board from the bottom housing and I/O ports. **Note:** The I/O port covers may come out with the logic board when it's removed.

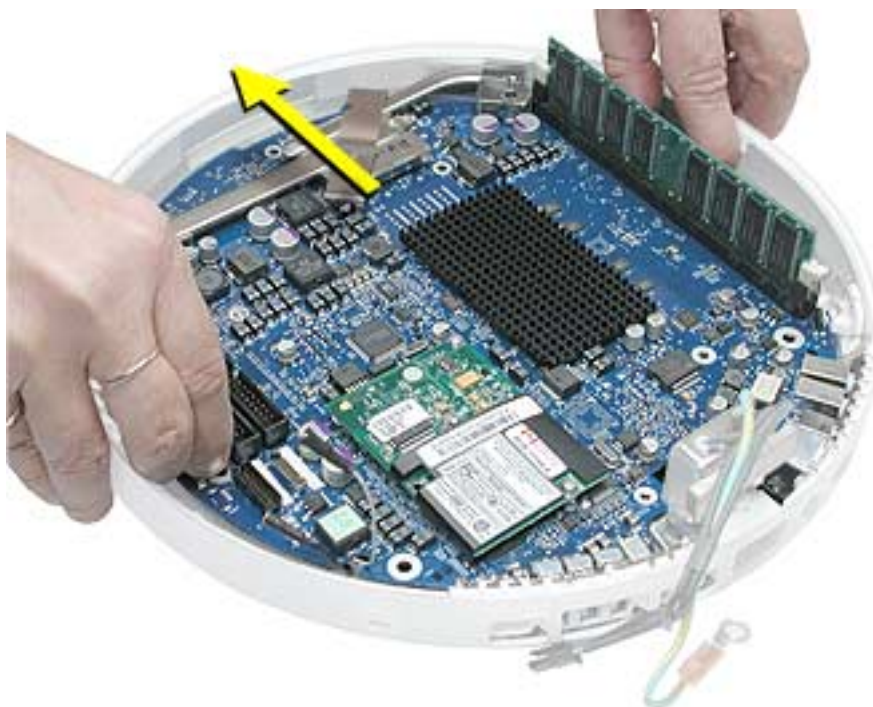

- Remove the I/O port covers from the logic board.

Warning: Whenever the logic board is separated from the bottom housing, you must install new thermal pads to three surfaces on the bottom housing. Failure to apply these pads whenever the logic board is separated from the bottom housing could cause these parts to overheat and could damage internal components.

Note: AFTER installing new thermal pads, if you must briefly re-separate the logic board from the housing, it is OK to retain the same, new pads as long as they are not handled excessively. Refer to “Thermal Pad Installation” in this chapter for detailed information.

Warning: Whenever the bottom housing is opened for service, you must do two things:

- You must clean the original thermal film from all thermal interface mating surfaces, and reapply thermal paste to the mating surfaces on the thermal pipe.
- You must tighten the four torx screws on the bottom housing to a minimum of 17 in.-lbs. Use a torque driver (service tool 076-0899) to ensure that the thermal pipe is firmly mated with the top base. If you do not have a torque driver, you must make sure the screws are tightened by hand **FIRMLY, BUT NOT FORCIBLY**.

Failure to follow these steps could cause the computer to overheat and damage internal components.

Refer to the topic “Thermal Paste Application” for detailed information.



Bluetooth Board and Cable

Tools

This procedure requires the following tools:

- Phillips #2 jeweler's screwdriver

Part Location

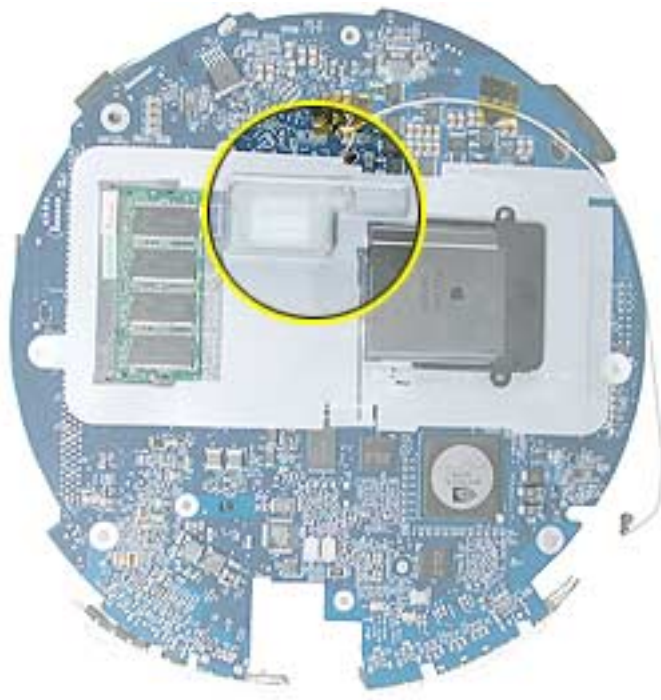

Preliminary Steps

Before you begin, do the following:

- Position the computer in the service stand.
- Remove the user access plate.
- Remove the bottom housing.
- Remove the RJ-11 board.
- Remove the logic board.

Procedure

1. Ground yourself. Remove the AirPort Extreme card and SO-DIMM memory (if present).



2. Remove the logic board protective cover to access the Bluetooth board



3. Remove the two screws (circled below) on the Bluetooth board.
4. Peel the Kapton tape off the Bluetooth extension cable. Disconnect the extension cable from the Bluetooth board. **Note:** The Bluetooth wireless extension cable is a separate service part from the Bluetooth board.

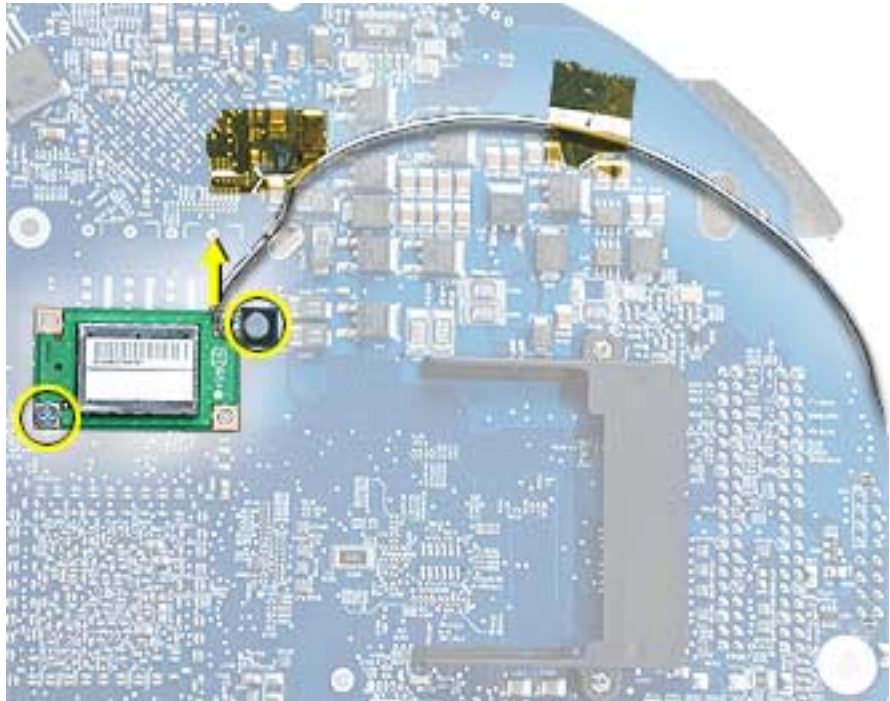

5. Lift the Bluetooth board from the connector on the logic board.

Warning: Whenever the logic board is separated from the bottom housing, you must install new thermal pads to three surfaces on the bottom housing. Failure to apply these pads whenever the logic board is separated from the bottom housing could cause these parts to overheat and could damage internal components.

Note: AFTER installing new thermal pads, if you must briefly re-separate the logic board from the housing, it is OK to retain the same, new pads as long as they are not handled excessively. Refer to “Thermal Pad Installation” in this chapter for detailed information.

Warning: Whenever the bottom housing is opened for service, you must do two things:

1. You must clean the original thermal film from all thermal interface mating surfaces, and reapply thermal paste to the mating surfaces on the thermal pipe.
2. You must tighten the four torx screws on the bottom housing to a minimum of 17 in.-lbs. Use a torque driver (service tool 076-0899) to ensure that the thermal pipe is firmly mated with the top base. If you do not have a torque driver, you must make sure the screws are tightened by hand **FIRMLY, BUT NOT FORCIBLY.**

Failure to follow these steps could cause the computer to overheat and damage internal components.

Refer to the topic “Thermal Paste Application” for detailed information.



I/O Port Covers

Tools

This procedure requires the following tools:

- No tools are required

Part Location

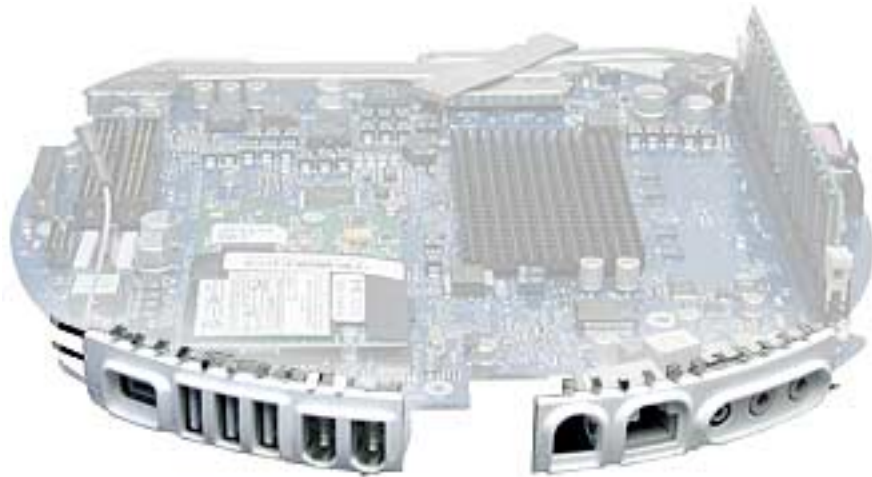

Preliminary Steps

Before you begin, do the following:

- Position the computer in the service stand.
- Remove the user access plate.
- Remove the bottom housing.
- Remove the RJ-11 board
- Remove the logic board.

Procedure

1. Gently pull the I/O port covers off the logic board.

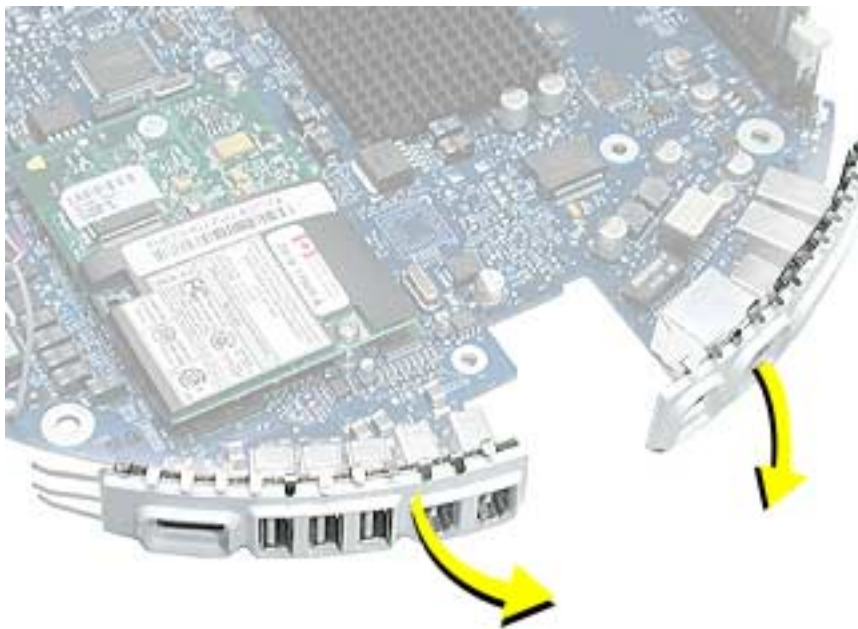

Warning: Whenever the bottom housing is opened for service, you must do two things:

1. You must clean the original thermal film from all thermal interface mating surfaces, and reapply thermal paste to the mating surfaces on the thermal pipe.
2. You must tighten the four torx screws on the bottom housing to a minimum of 17 in.-lbs. Use a torque driver (service tool 076-0899) to ensure that the thermal pipe is firmly mated with the top base. If you do not have a torque driver, you must make sure the screws are tightened by hand **FIRMLY, BUT NOT FORCIBLY**.

Failure to follow these steps could cause the computer to overheat and damage internal components.

Refer to the topic “Thermal Paste Application” for detailed information.

Warning: Whenever the logic board is separated from the bottom housing, you must install new thermal pads to three surfaces on the bottom housing. Failure to apply these pads whenever the logic board is separated from the bottom housing could cause these parts to overheat and could damage internal components.

Note: AFTER installing new thermal pads, if you must briefly re-separate the logic board from the housing, it is OK to retain the same, new pads as long as they are not handled excessively. Refer to “Thermal Pad Installation” in this chapter for detailed information.



AirPort Antenna Extension Cable

Tools

This procedure requires the following tools:

- No tools are required

Part Location



Preliminary Steps

Before you begin, do the following:

- Position the computer in the service stand.
- Remove the user access plate.
- Remove the bottom housing.
- Remove the RJ-11 board
- Remove the logic board.

Procedure

1. Release the extension cable from the plastic cable clips to remove the cable from the bottom housing.

Replacement Note: Be careful not to pinch the antenna extension cable when replacing it.

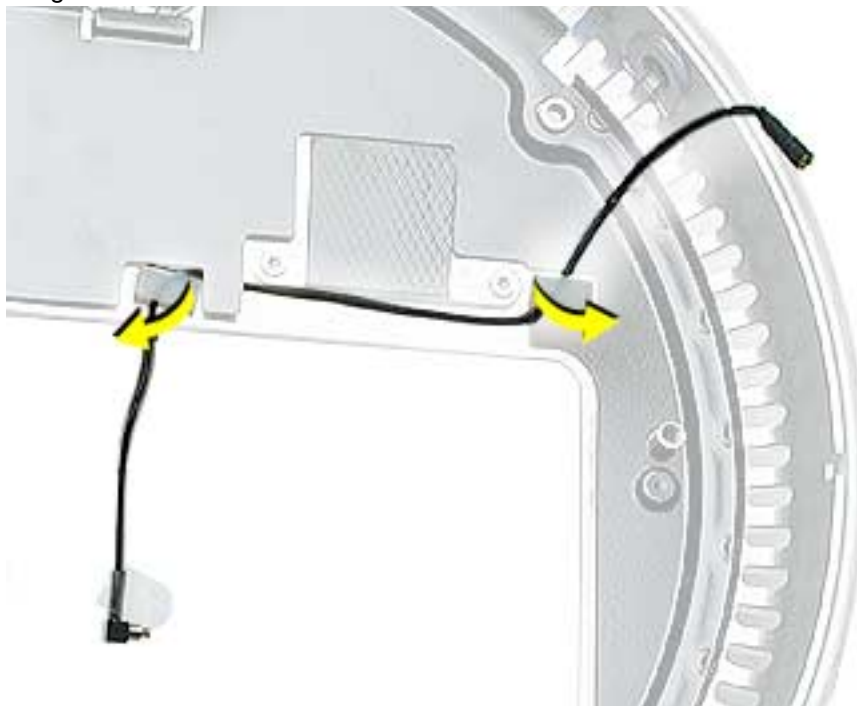

Warning: Whenever the bottom housing is opened for service, you must do two things:

1. You must clean the original thermal film from all thermal interface mating surfaces, and reapply thermal paste to the mating surfaces on the thermal pipe.
2. You must tighten the four torx screws on the bottom housing to a minimum of 17 in.-lbs. Use a torque driver (service tool 076-0899) to ensure that the thermal pipe is firmly mated with the top base. If you do not have a torque driver, you must make sure the screws are tightened by hand **FIRMLY, BUT NOT FORCIBLY**.

Failure to follow these steps could cause the computer to overheat and damage internal components.

Refer to the topic “Thermal Paste Application” for detailed information.

Warning: Whenever the logic board is separated from the bottom housing, you must install new thermal pads to three surfaces on the bottom housing. Failure to apply these pads whenever the logic board is separated from the bottom housing could cause these parts to overheat and could damage internal components.

Note: AFTER installing new thermal pads, if you must briefly re-separate the logic board from the housing, it is OK to retain the same, new pads as long as they are not handled excessively. Refer to “Thermal Pad Installation” in this chapter for detailed information.



Thermal Pad Installation

Tools

- No tools are required.
- Thermal pad kit (076-0925)

Part Location

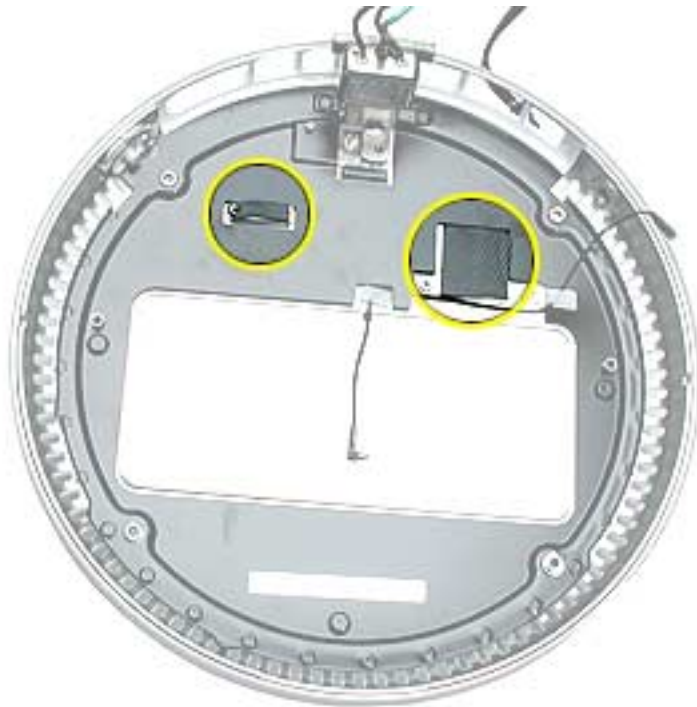

Warning: Whenever the logic board is separated from the bottom housing, you must install new thermal pads to two surfaces on the bottom housing. Failure to apply these pads whenever the logic board is separated from the bottom housing could cause these parts to overheat and could damage internal components.

Note: AFTER installing new thermal pads, if you must briefly re-separate the logic board from the housing, it is OK to retain the same, new pads as long as they are not handled excessively.

Procedure

1. Remove the old thermal pads from the bottom housing. **Note:** If you don't see the two thermal pads on the bottom housing, check the under side of the logic board. The thermal pads may stick to the logic board. Always remove the old thermal pads, and install new pads if you are taking the unit apart to this level.



2. Using the thermal pad kit, remove the clear protective backing from the new thermal pads.
3. Place the new thermal pads on the bottom housing. Press down on the blue protective backing to make sure the thermal pad has even contact with the bottom housing. There should be no air pockets.
4. Remove the blue protective backing from the new thermal pad. **Note:** Avoid unnecessary contact with either side of the thermal pad as dirt and body oils reduce the thermal pad's conductivity.
5. Slide the logic board back into the bottom housing (make sure the I/O port covers are on the logic board).



AC Line Filter

Tools

This procedure requires the following tools:

- Torx-10 screwdriver

Part Location

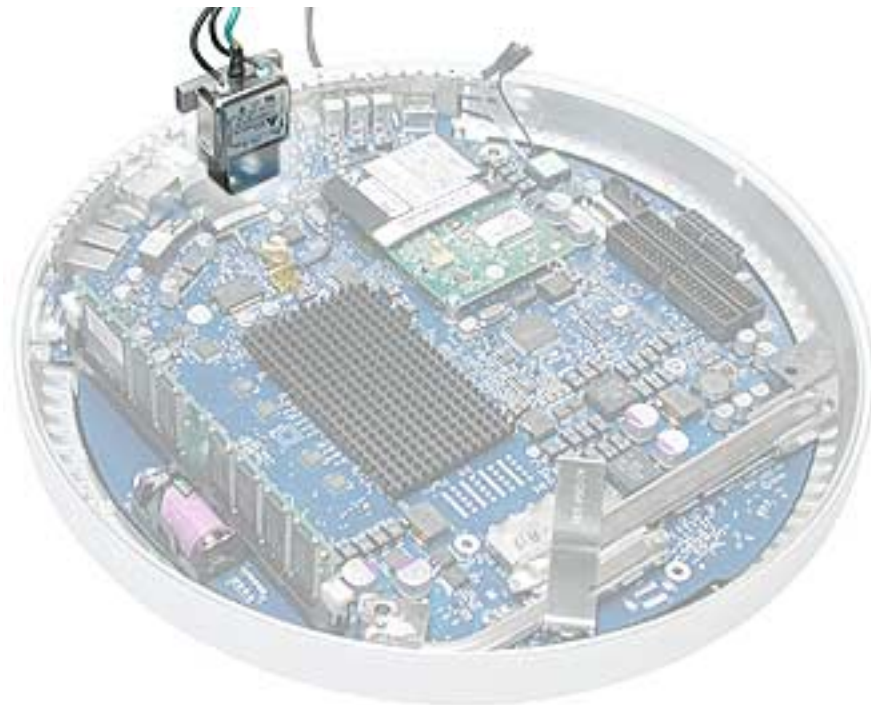

Preliminary Steps

Before you begin, do the following:

- Position the computer in the service stand.
- Remove the user access plate.
- Remove the bottom housing.
- Remove the RJ-11 board.
- Remove the logic board.

Procedure

1. Peel the black insulator on the bottom housing back to access the AC line filter screws.



2. Remove two screws and lift the AC line filter from the bottom housing. **Note:** The port plug may fall out of the AC filter port when you remove the AC line filter. Replace the plug into the opening on the bottom housing before reinstalling the AC line filter.



Warning: Whenever the bottom housing is opened for service, you must do two things:

1. You must clean the original thermal film from all thermal interface mating surfaces, and reapply thermal paste to the mating surfaces on the thermal pipe.
2. You must tighten the four torx screws on the bottom housing to a minimum of 17 in.-lbs. Use a torque driver (service tool 076-0899) to ensure that the thermal pipe is firmly mated with the top base. If you do not have a torque driver, you must make sure the screws are tightened by hand **FIRMLY, BUT NOT FORCIBLY**.

Failure to follow these steps could cause the computer to overheat and damage internal components.

Refer to the topic “Thermal Paste Application” for detailed information.

Warning: Whenever the logic board is separated from the bottom housing, you must install new thermal pads to three surfaces on the bottom housing. Failure to apply these pads whenever the logic board is separated from the bottom housing could cause these parts to overheat and could damage internal components.

Note: AFTER installing new thermal pads, if you must briefly re-separate the logic board from the housing, it is OK to retain the same, new pads as long as they are not handled excessively. Refer to “Thermal Pad Installation” in this chapter for detailed information.



Drive Carrier Assembly (Optical and Hard Drive)

Tools

This procedure requires the following tools:

- Torx-10 screwdriver

Part Location



Preliminary Steps

Before you begin, do the following:

- Position the computer in the service stand with the door facing up.
- Remove the user access plate.
- Remove the bottom housing.

Procedure

1. Rotate the base unit so the optical drive door is facing to the right.
2. Remove six screws; two on the EMI shield (with copper tape) and four attaching the drive to the Faraday cage (chassis). Carefully lift the shield and copper tape off the drive. **Replacement Note:** When replacing the drive EMI shield, be sure to use the two shorter screws.

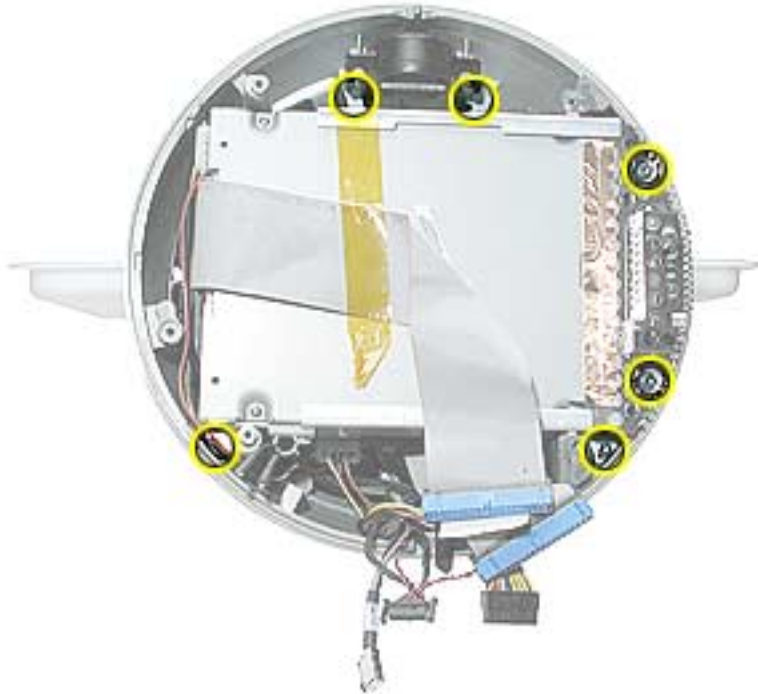

3. Remove the Airport and Bluetooth antennas from the plastic clip on the side of the drive carrier.



4. Grasp the carrier by the top and bottom edges. Wiggle the drive carrier out of the chassis pulling the carrier in the direction of the arrow. **Note:** The carrier fits snugly into the chassis.

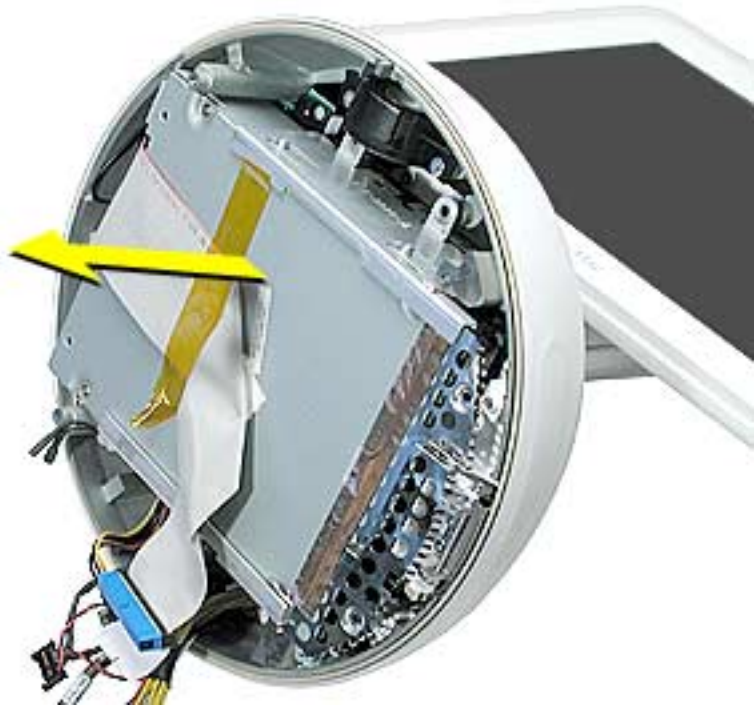

5. Disconnect the two power cables; one attaches to the optical drive and the other attaches to the hard drive.

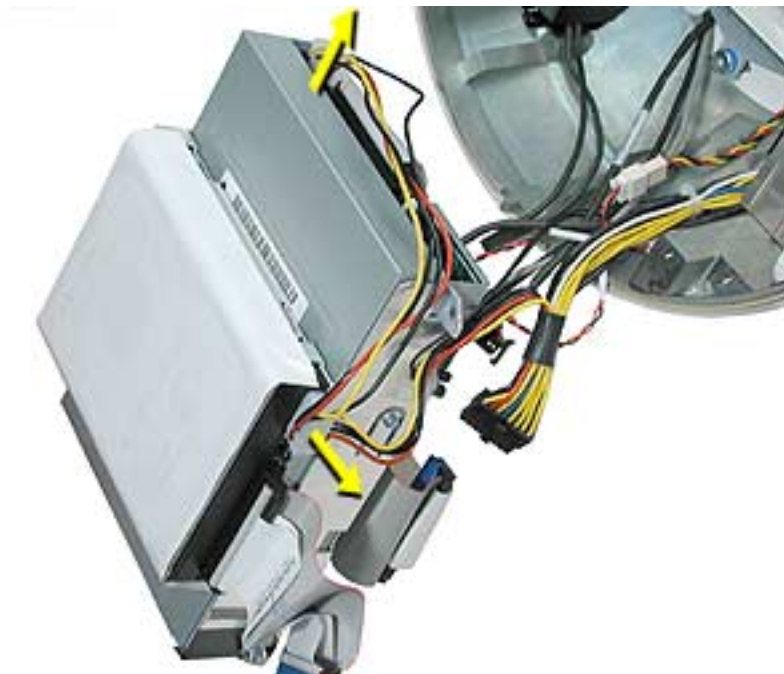

6. To remove the hard drive from the carrier, peel the white wrapper up to access the screws (two on each side). Remove the screws, disconnect the data cable, and remove the hard drive out of the carrier.

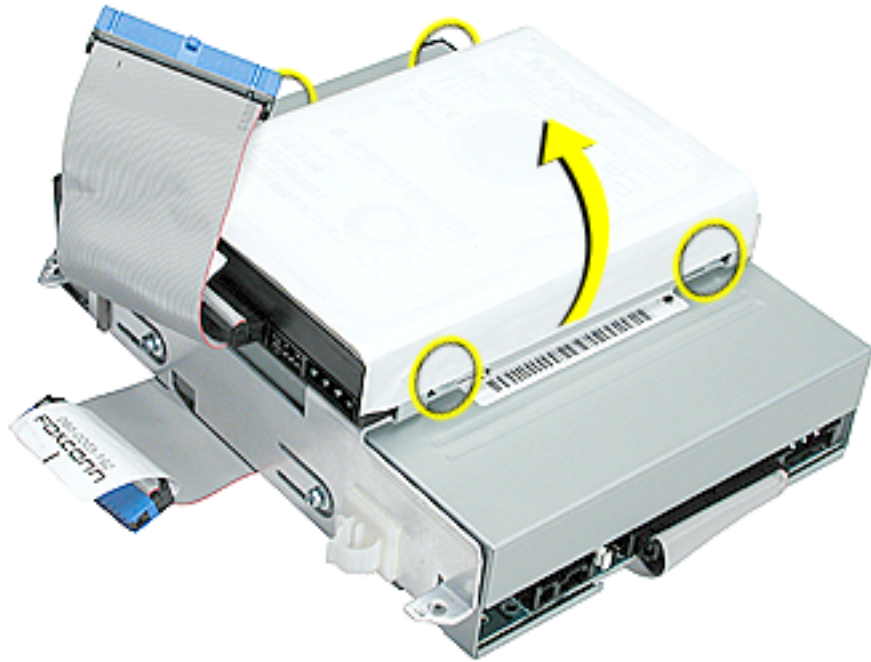

7. To remove the optical drive, remove four screws (shown by dashed lines), disconnect the optical drive data cable (see lower arrow), and slide the optical drive out of the carrier.

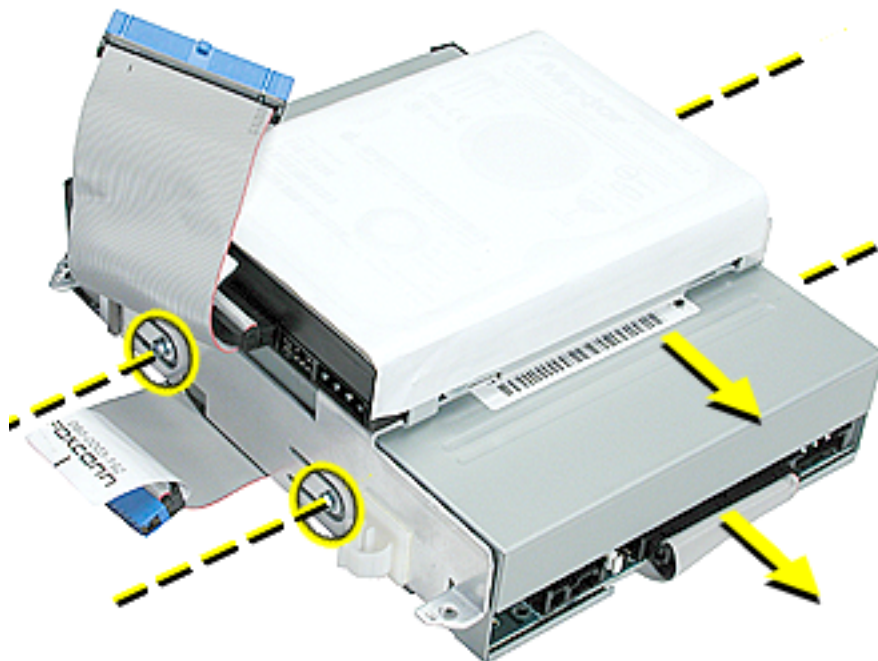

Warning: Whenever the bottom housing is opened for service, you must do two things:

1. You must clean the original thermal film from all thermal interface mating surfaces, and reapply thermal paste to the mating surfaces on the thermal pipe.
2. You must tighten the four torx screws on the bottom housing to a minimum of 17 in.-lbs. Use a torque driver (service tool 076-0899) to ensure that the thermal pipe is firmly mated with the top base. If you do not have a torque driver, you must make sure the screws are tightened by hand **FIRMLY, BUT NOT FORCIBLY**.

Failure to follow these steps could cause the computer to overheat and damage internal components.

Refer to the topic “Thermal Paste Application” for detailed information.



Power Supply

Tools

This procedure requires the following tools:

- Torx-10 screwdriver

Part Location

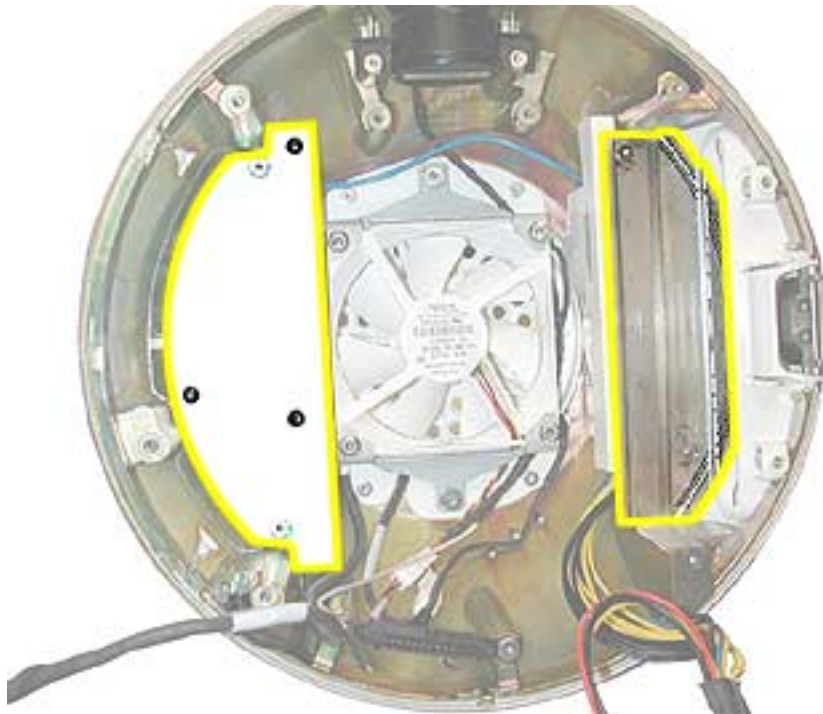

Preliminary Steps

Before you begin, do the following:

- Position the computer in the service stand and rotate the door to the right.
- Remove the user access plate.
- Remove the bottom housing.
- Remove the drive carrier assembly.

Procedure

1. Remove the two power supply screws circled below.

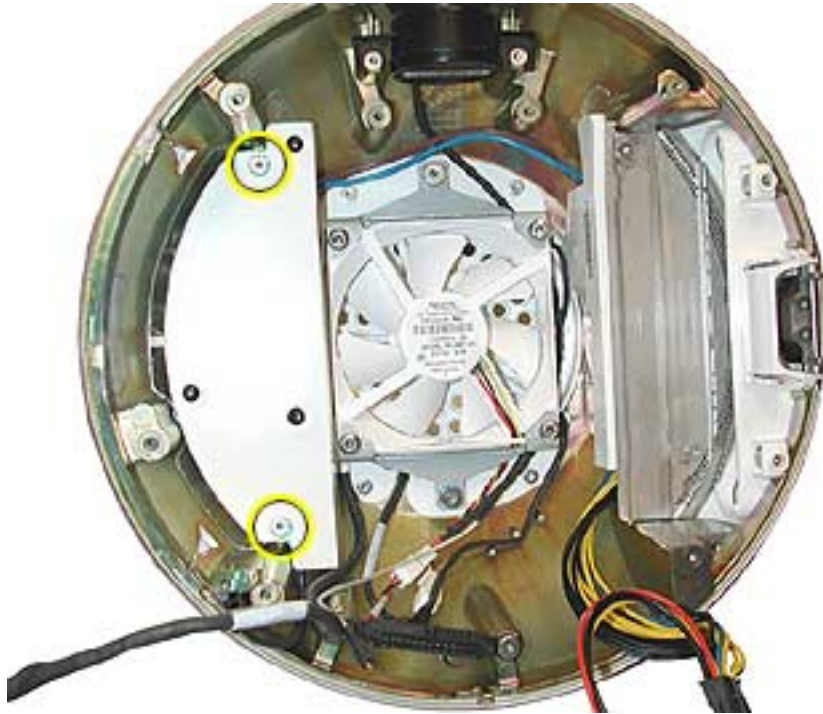

2. Open the optical drive door as shown. Support the metal plate and power supply as you remove the four screws.

Important: The two screws near the door hinge are shorter than the other power supply screws. Failure to replace the shorter screws into their correct location will scratch the top housing. See step 4, Replacement Note.



3. Lift the power supply and metal shield out of the chassis (Faraday cage).

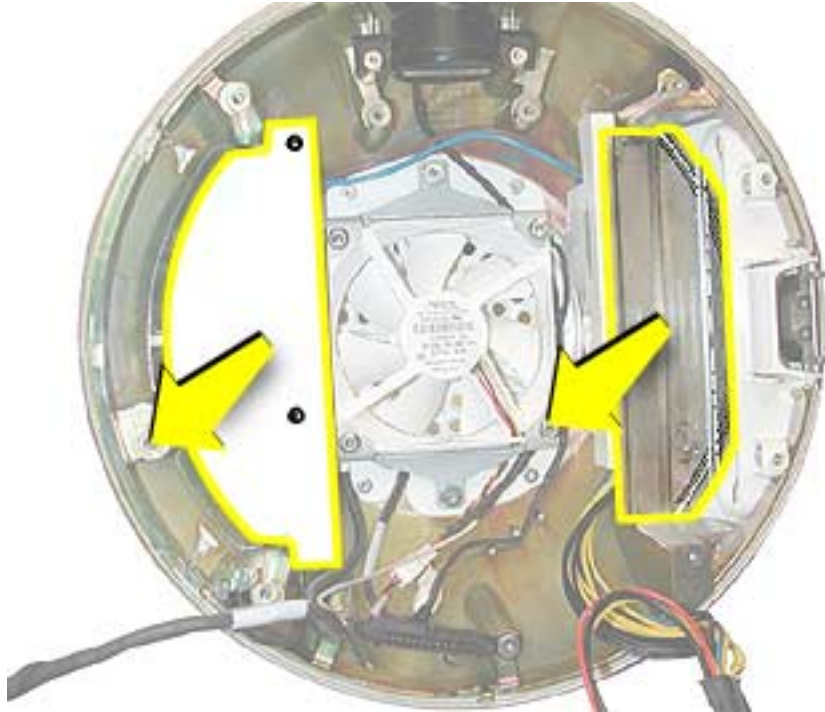

4. **Replacement Note:** When replacing the metal shield (see picture above) that sits on top of the power supply, install the two shorter screws near the optical door. If the longer screws are installed by mistake, the screws will scratch the inside of the housing (circled below).



Warning: Whenever the bottom housing is opened for service, you must do two things:

1. You must clean the original thermal film from all thermal interface mating surfaces, and reapply thermal paste to the mating surfaces on the thermal pipe.
2. You must tighten the four torx screws on the bottom housing to a minimum of 17 in.-lbs. Use a torque driver (service tool 076-0899) to ensure that the thermal pipe is firmly mated with the top base. If you do not have a torque driver, you must make sure the screws are tightened by hand **FIRMLY, BUT NOT FORCIBLY**.

Failure to follow these steps could cause the computer to overheat and damage internal components.

Refer to the topic “Thermal Paste Application” for detailed information.



Optical Drive Door

Tools

This procedure requires the following tools:

- Torx-10 screwdriver
- Needlenose pliers

Part Location



Preliminary Steps

Before you begin, do the following:

- Position the computer in the service stand.
- Remove the user access plate.
- Remove the bottom housing.
- Remove the drive carrier assembly.

Procedure

1. Remove four screws on the power supply shield. Set the shield aside.
Important: The two screws near the door hinge are shorter than the other power supply screws. Failure to replace the shorter screws to their correct location will scratch the top housing. See the Power Supply topic, step 4, Replacement Note, for a picture of what happens when the wrong screws are inserted in the wrong location.



- Slide the optical door guide off the chassis and the door hinge tabs (circled).



- Carefully remove the two door springs with a needlenose pliers.



4. Remove the door hinge screws.



5. Open the door.

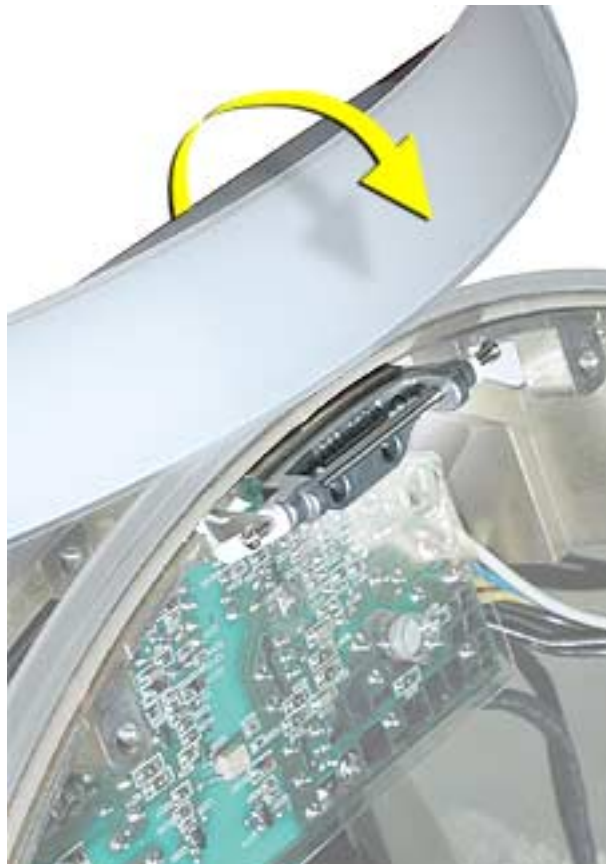

6. Slide the door and hinge off the chassis.



Warning: Whenever the bottom housing is opened for service, you must do two things:

1. You must clean the original thermal film from all thermal interface mating surfaces, and reapply thermal paste to the mating surfaces on the thermal pipe.
2. You must tighten the four torx screws on the bottom housing to a minimum of 17 in.-lbs. Use a torque driver (service tool 076-0899) to ensure that the thermal pipe is firmly mated with the top base. If you do not have a torque driver, you must make sure the screws are tightened by hand **FIRMLY, BUT NOT FORCIBLY**.

Failure to follow these steps could cause the computer to overheat and damage internal components.

Refer to the topic “Thermal Paste Application” for detailed information.



Speaker, Internal

Tools

This procedure requires the following tools:

- Torx-10 screwdriver

Part Location



Preliminary Steps

Before you begin, do the following:

- Position the computer in the service stand.
- Remove the user access plate.
- Remove the bottom housing.
- Remove the drive carrier assembly.

Procedure

1. Loosen the two screws enough to slide the speaker off the metal posts. Disconnect the speaker cable.



Warning: Whenever the bottom housing is opened for service, you must do two things:

1. You must clean the original thermal film from all thermal interface mating surfaces, and reapply thermal paste to the mating surfaces on the thermal pipe.
2. You must tighten the four torx screws on the bottom housing to a minimum of 17 in.-lbs. Use a torque driver (service tool 076-0899) to ensure that the thermal pipe is firmly mated with the top base. If you do not have a torque driver, you must make sure the screws are tightened by hand **FIRMLY, BUT NOT FORCIBLY**.

Failure to follow these steps could cause the computer to overheat and damage internal components.

Refer to the topic “Thermal Paste Application” for detailed information.



Fan

Tools

This procedure requires the following tools:

- Torx-15 screwdriver

Part Location



Preliminary Steps

Before you begin, do the following:

- Position the computer in the service stand.
- Remove the user access plate.
- Remove the bottom housing.
- Remove the drive carrier assembly.

Procedure

1. Remove the two fan screws and disconnect the fan connector.

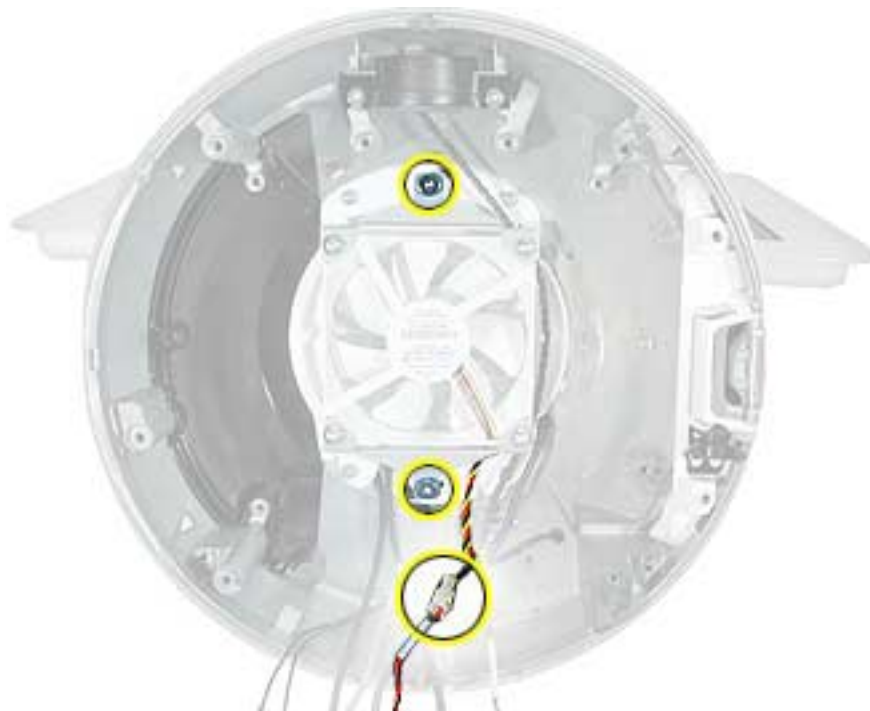

2. Pull the fan out of the chassis (Faraday cage). **Note:** The replacement fan includes the mounting bracket.

Warning: Whenever the bottom housing is opened for service, you must do two things:

1. You must clean the original thermal film from all thermal interface mating surfaces, and reapply thermal paste to the mating surfaces on the thermal pipe.
2. You must tighten the four torx screws on the bottom housing to a minimum of 17 in.-lbs. Use a torque driver (service tool 076-0899) to ensure that the thermal pipe is firmly mated with the top base. If you do not have a torque driver, you must make sure the screws are tightened by hand **FIRMLY, BUT NOT FORCIBLY**.

Failure to follow these steps could cause the computer to overheat and damage internal components.

Refer to the topic “Thermal Paste Application” for detailed information.



Power Supply Insulators

Tools

No tools are required for this procedure.

Part Location



Note: Insulator color and transparency may vary from those shown above.

Preliminary Steps

Before you begin, do the following:

- Position the computer in the service stand.
- Remove the user access plate.
- Remove the bottom housing.
- Remove the drive carrier assembly.
- Remove the power supply.

Procedure

1. Carefully pull the insulators from the chassis (Faraday cage). These are attached to the chassis with double-sided tape.

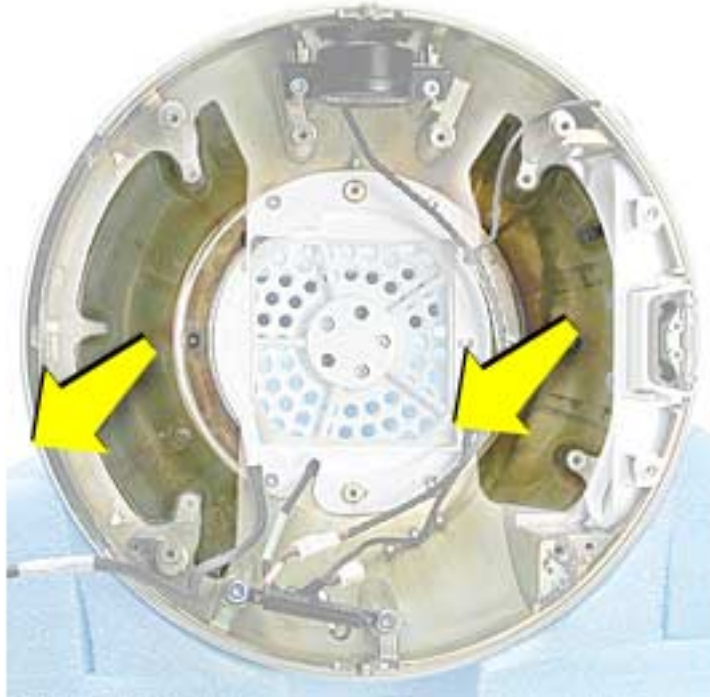

Warning: Whenever the bottom housing is opened for service, you must do two things:

1. You must clean the original thermal film from all thermal interface mating surfaces, and reapply thermal paste to the mating surfaces on the thermal pipe.
2. You must tighten the four torx screws on the bottom housing to a minimum of 17 in.-lbs. Use a torque driver (service tool 076-0899) to ensure that the thermal pipe is firmly mated with the top base. If you do not have a torque driver, you must make sure the screws are tightened by hand **FIRMLY, BUT NOT FORCIBLY**.

Failure to follow these steps could cause the computer to overheat and damage internal components.

Refer to the topic “Thermal Paste Application” for detailed information.



Fan Retainer Bracket (under fan)

Tools

This procedure requires the following tools:

- Torx-10 screwdriver

Part Location



Preliminary Steps

Before you begin, do the following:

- Position the computer in the service stand.
- Remove the user access plate.
- Remove the bottom housing.
- Remove the drive carrier assembly.
- Remove the power supply.
- Remove the fan.

Procedure

1. Remove the four screws connecting the fan bracket to the chassis (Faraday cage).



2. Lift the fan bracket out of the chassis. Note the orientation of the neck cables (see below) in the fan bracket before removing the cables. For orientation purposes, the drive door would be on the right.

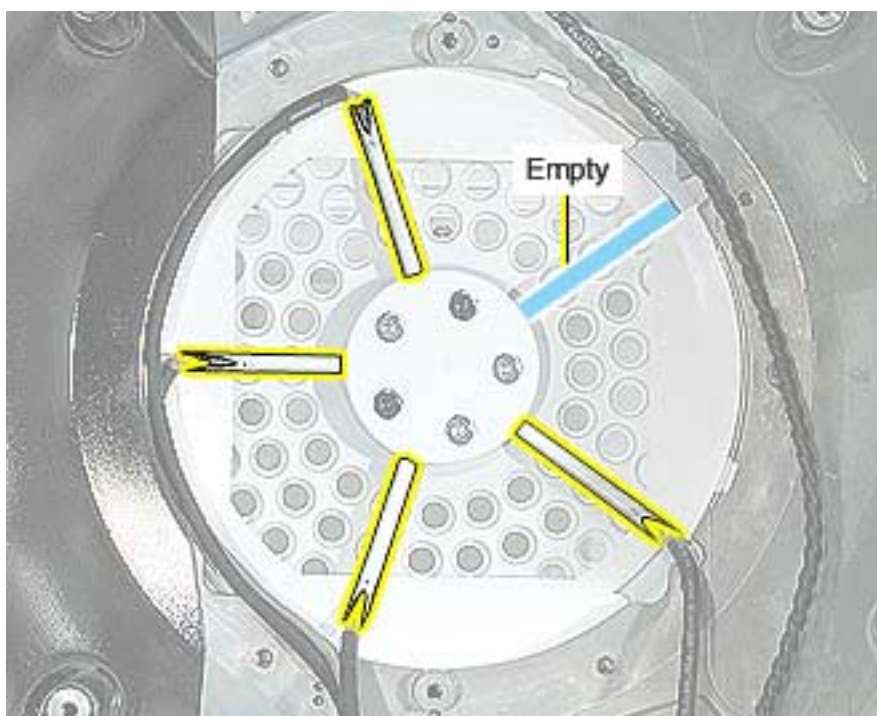

Warning: Whenever the bottom housing is opened for service, you must do two things:

1. You must clean the original thermal film from all thermal interface mating surfaces, and reapply thermal paste to the mating surfaces on the thermal pipe.
2. You must tighten the four torx screws on the bottom housing to a minimum of 17 in.-lbs. Use a torque driver (service tool 076-0899) to ensure that the thermal pipe is firmly mated with the top base. If you do not have a torque driver, you must make sure the screws are tightened by hand **FIRMLY, BUT NOT FORCIBLY**.

Failure to follow these steps could cause the computer to overheat and damage internal components.

Refer to the topic “Thermal Paste Application” for detailed information.



Fan Gasket

Tools

No tools are required for this procedure.

Part Location

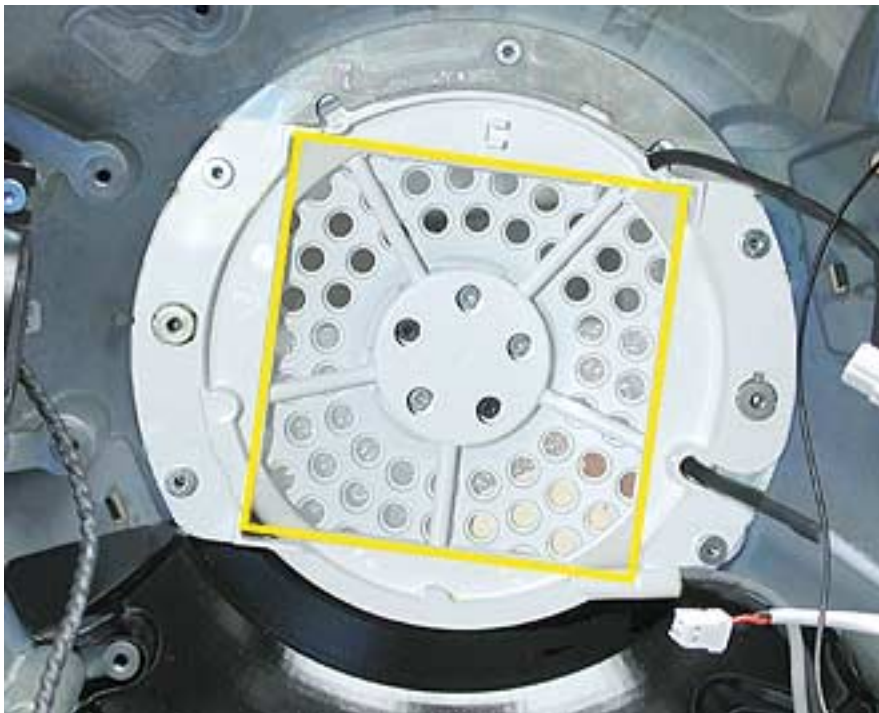

Preliminary Steps

Before you begin, do the following:

- Position the computer in the service stand.
- Remove the user access plate.
- Remove the bottom housing.
- Remove the drive carrier assembly.
- Remove the power supply.
- Remove the fan.
- Remove the fan retainer bracket.

Procedure

1. Remove the fan retainer bracket and turn it over. Gently peel the fan gasket off the back of the fan bracket.



Warning: Whenever the bottom housing is opened for service, you must do two things:

1. You must clean the original thermal film from all thermal interface mating surfaces, and reapply thermal paste to the mating surfaces on the thermal pipe.
2. You must tighten the four torx screws on the bottom housing to a minimum of 17 in.-lbs. Use a torque driver (service tool 076-0899) to ensure that the thermal pipe is firmly mated with the top base. If you do not have a torque driver, you must make sure the screws are tightened by hand **FIRMLY, BUT NOT FORCIBLY**.

Failure to follow these steps could cause the computer to overheat and damage internal components.

Refer to the topic “Thermal Paste Application” for detailed information.



Cap, Neck Spoke Retainer

Tools

This procedure requires the following tools:

- Torx-10 screwdriver

Part Location

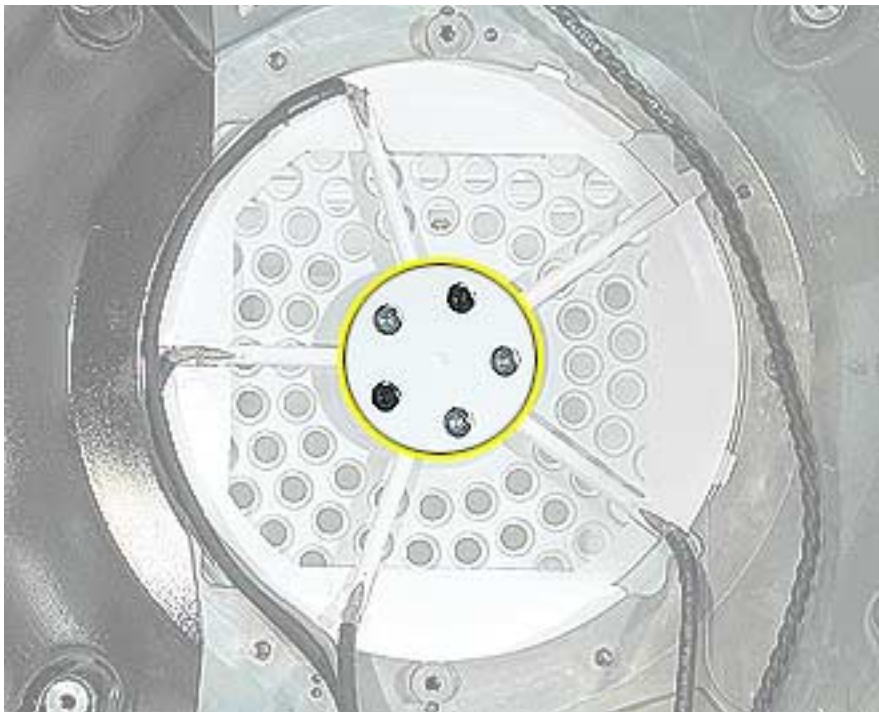

Preliminary Steps

Before you begin, do the following:

- Position the computer in the service stand.
- Remove the user access plate.
- Remove the bottom housing.
- Remove the drive carrier assembly.
- Remove the power supply.
- Remove the fan.

Procedure

1. Before removing the neck cap screws, note the cable routing, including the location of the empty spoke.

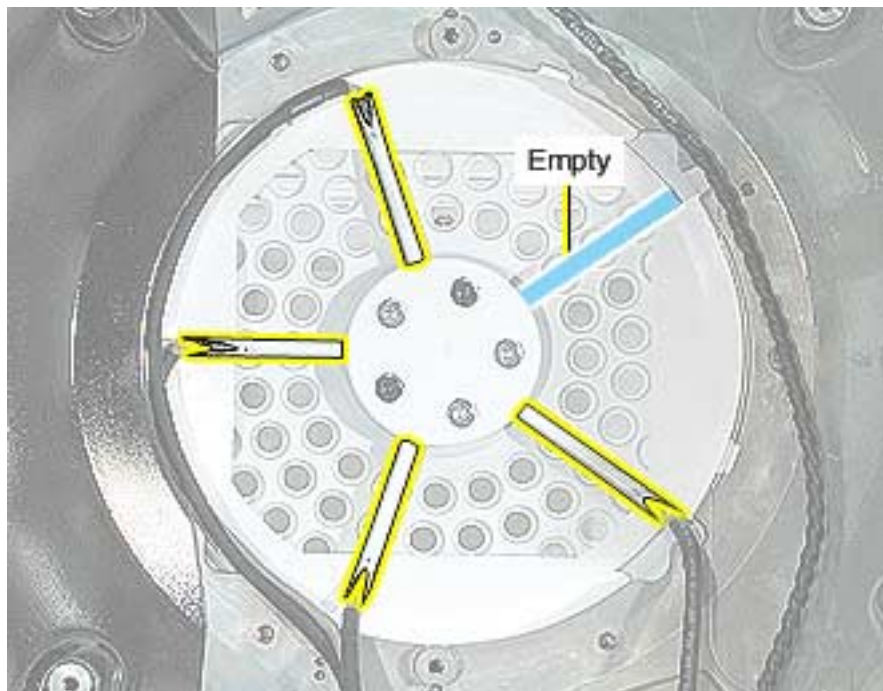

2. **Note:** There are five screws on the neck cap. For this step, remove only the three silver screws and the neck cap. (The two black screws secure the neck to the base.)



Warning: Whenever the bottom housing is opened for service, you must do two things:

1. You must clean the original thermal film from all thermal interface mating surfaces, and reapply thermal paste to the mating surfaces on the thermal pipe.
2. You must tighten the four torx screws on the bottom housing to a minimum of 17 in.-lbs. Use a torque driver (service tool 076-0899) to ensure that the thermal pipe is firmly mated with the top base. If you do not have a torque driver, you must make sure the screws are tightened by hand **FIRMLY, BUT NOT FORCIBLY**.

Failure to follow these steps could cause the computer to overheat and damage internal components.

Refer to the topic “Thermal Paste Application” for detailed information.



Chassis (Faraday Cage)

Tools

This procedure requires the following tools:

- Torx-10 screwdriver
- Torx-8 screwdriver for the logo screw

Part Location



Preliminary Steps

Before you begin, do the following:

- Position the computer in the service stand.
- Remove the user access plate.
- Remove the bottom housing.
- Remove the drive carrier assembly.

- Remove the power supply.
- Remove the fan.
- Remove the plastic cable retainer (under the fan).
- Remove the neck spoke retainer cap.

Procedure

1. Pull the neck cables/white spokes out of their slots and into a bundle. Bundle the neck cables to one side. Supporting the base, remove the two black screws that connect the neck to the Faraday base.

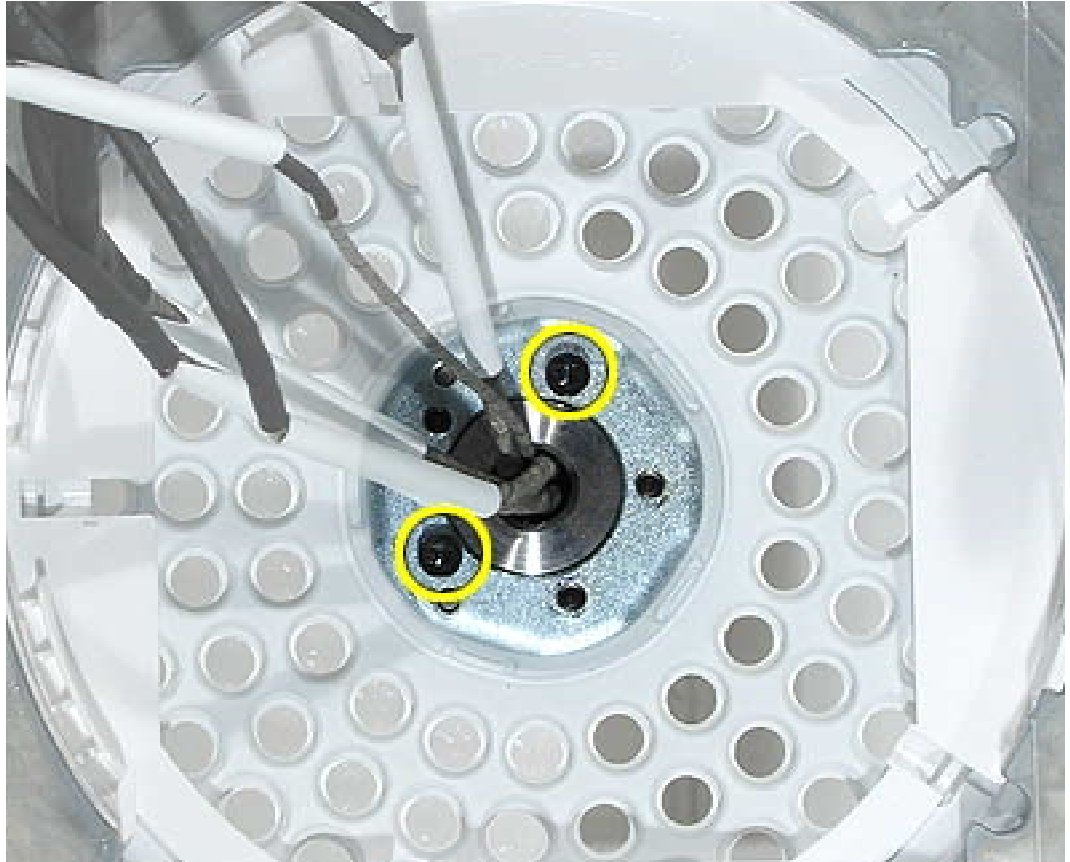

-
2. Carefully feed the neck cables through the hole in the Faraday cage. **Important:** The Faraday cage is very heavy and has sharp edges; handle with care.

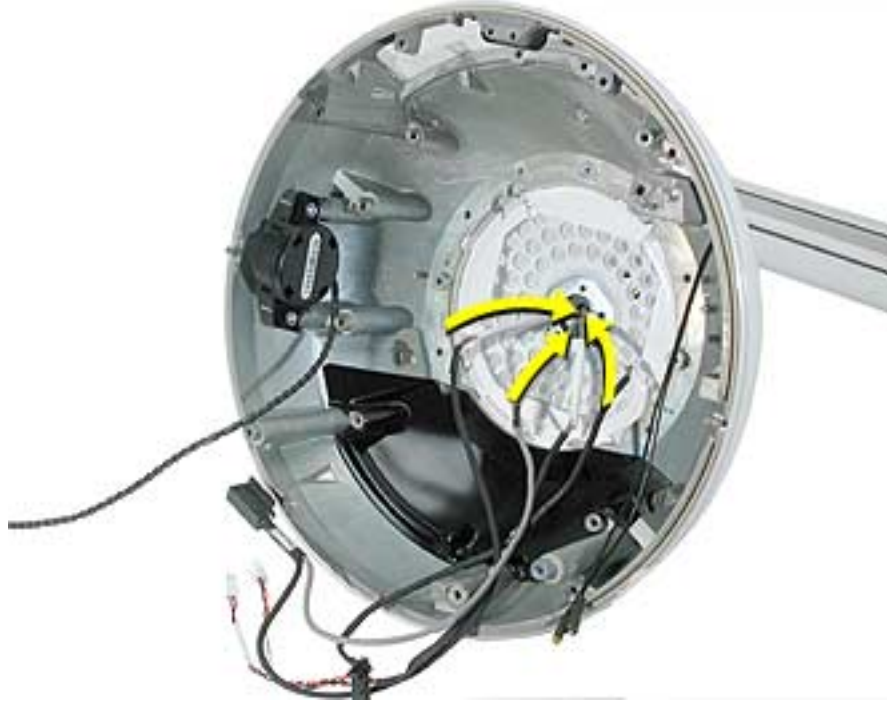

3. Pull the outer shell (with Faraday attached) away from the neck. **Note:** There is no need to remove the outer shell from the Faraday unless you are replacing the antenna or the outer shell. If you are removing the shell from the Faraday cage, go on to the next step.



4. **Note:** Perform this step only if you are replacing the antenna or the outer shell. Remove one screw in the base of the Faraday cage to separate the shell from the Faraday cage.



Replacement Notes:

Faraday cage: Look at the exploded view diagram during reassembly. First, attach the Faraday top cover to the top (OUTSIDE) of the Faraday cage **as shown below**; the Faraday top cover is keyed. Next, thread the neck cables through the hole in the Faraday cage and install the Faraday cage into the top plastic housing. Replace the screw that holds the plastic housing to the chassis. Attach the black neck cap screws to connect the neck to the chassis. Route the neck cables correctly in the base and replace the fan bracket retainer and three remaining neck cap screws.

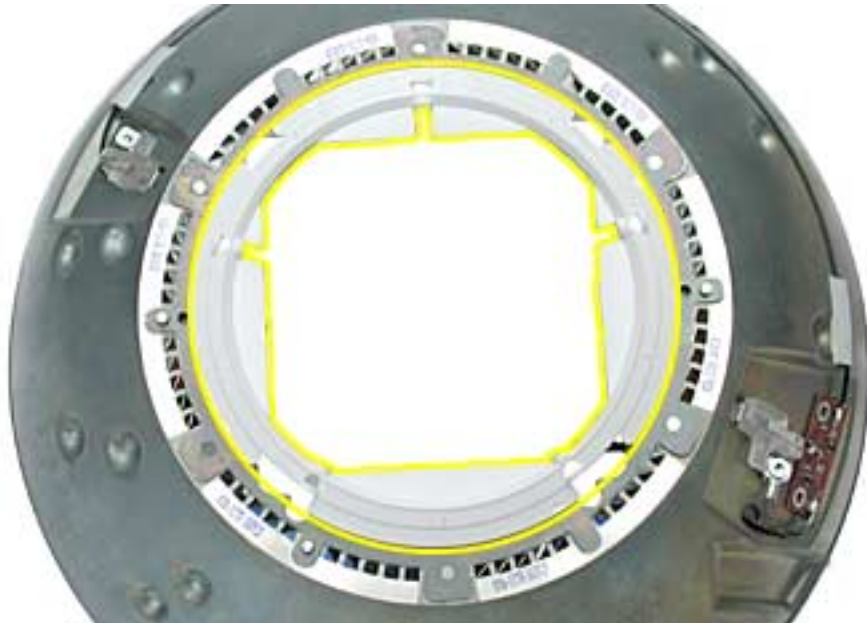

Warning: Whenever the bottom housing is opened for service, you must do two things:

1. You must clean the original thermal film from all thermal interface mating surfaces, and reapply thermal paste to the mating surfaces on the thermal pipe.
2. You must tighten the four torx screws on the bottom housing to a minimum of 17 in.-lbs. Use a torque driver (service tool 076-0899) to ensure that the thermal pipe is firmly mated with the top base. If you do not have a torque driver, you must make sure the screws are tightened by hand **FIRMLY, BUT NOT FORCIBLY**.

Failure to follow these steps could cause the computer to overheat and damage internal components.

Refer to the topic “Thermal Paste Application” for detailed information.



Antenna, Wireless

Tools

This procedure requires the following tools:

- Torx-8 screwdriver

Part Location



Preliminary Steps

Before you begin, do the following:

- Position the computer in the service stand.
- Remove the user access plate.
- Remove the bottom housing.
- Remove the drive carrier assembly.
- Remove the power supply.
- Remove the power supply insulators.
- Remove the optical drive door.
- Remove the internal speaker.
- Remove the fan.

-
- Remove the fan bracket under the fan.
 - Remove the neck spoke retainer cap.
 - Remove the blind mate connector screws.
 - Remove the Faraday cage.

Procedure

1. Remove the mounting screw and unclip the board from the Faraday cage. Remove any tape, and carefully separate the antenna board cable from the Faraday cage.

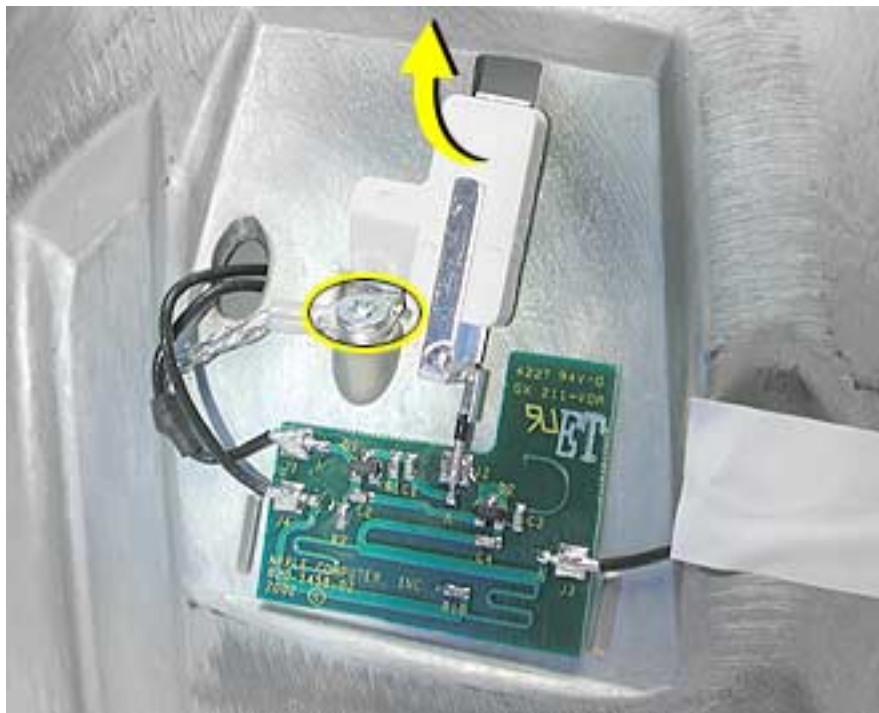

2. Remove the second mounting screw to unclip the antenna from the Faraday cage.



Warning: Whenever the bottom housing is opened for service, you must do two things:

1. You must clean the original thermal film from all thermal interface mating surfaces, and reapply thermal paste to the mating surfaces on the thermal pipe.
2. You must tighten the four torx screws on the bottom housing to a minimum of 17 in.-lbs. Use a torque driver (service tool 076-0899) to ensure that the thermal pipe is firmly mated with the top base. If you do not have a torque driver, you must make sure the screws are tightened by hand **FIRMLY, BUT NOT FORCIBLY**.

Failure to follow these steps could cause the computer to overheat and damage internal components.

Refer to the topic “Thermal Paste Application” for detailed information.



Housing, Outer Shell, Plastic

Tools

This procedure requires the following tools:

- Torx-10 screwdriver

Part Location



Preliminary Steps

Before you begin, do the following:

- Position the computer in the service stand.
- Remove the user access plate.
- Remove the bottom housing.
- Remove the drive carrier assembly.
- Remove the power supply.
- Remove the power supply insulators.
- Remove the optical drive door.
- Remove the fan.
- Remove the fan bracket under the fan.

-
- Remove the neck spoke retainer cap.
 - Remove the blind mate connector screws.

Procedure

1. Remove the two black screws that connect the neck to the base.

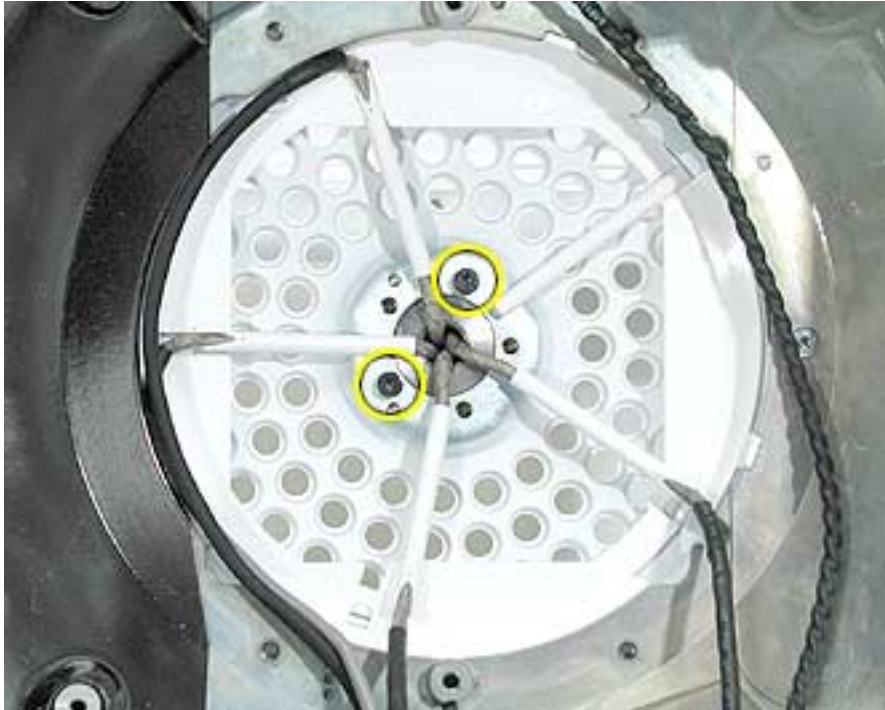

2. Carefully feed the neck cables through the hole on the vent cap shown below.

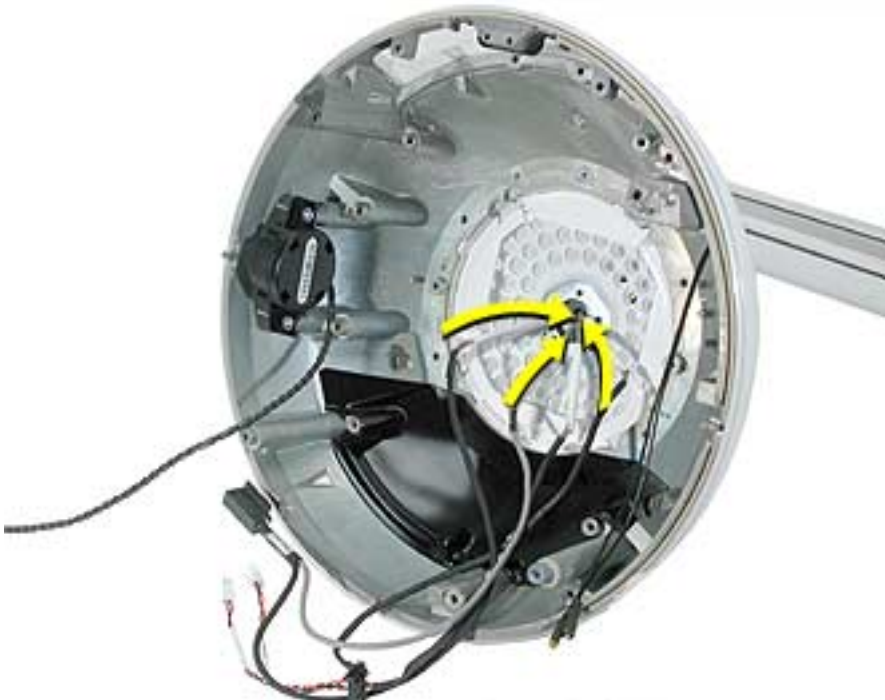

- Next, carefully separate the outer plastic housing from the neck.



- Remove one screw in the base of the Faraday cage to separate the white outer shell from the Faraday cage.



Warning: Whenever the bottom housing is opened for service, you must do two things:

1. You must clean the original thermal film from all thermal interface mating surfaces, and reapply thermal paste to the mating surfaces on the thermal pipe.
2. You must tighten the four torx screws on the bottom housing to a minimum of 17 in.-lbs. Use a torque driver (service tool 076-0899) to ensure that the thermal pipe is firmly mated with the top base. If you do not have a torque driver, you must make sure the screws are tightened by hand **FIRMLY, BUT NOT FORCIBLY**.

Failure to follow these steps could cause the computer to overheat and damage internal components.

Refer to the topic “Thermal Paste Application” for detailed information.



Display, 17" Flat Panel

Tools

This procedure requires the following tools:

- 1.5 mm hex tool
- Torx-10 screwdriver

Important: If you are replacing the 17-inch display panel, be sure to install the display shield and EMI gaskets that come with the new LCD panel. Installation instructions are included with the new display panel.

Part Location



Preliminary Steps

Before you begin, do the following:

- Position the computer in the service stand.

Procedure

1. Remove three screws that connect the back cover to the flat panel LCD display. Use the 1.5 mm hex tool to remove these screws.



2. Support the back cover and push on the display bezel (as shown) to separate the display bezel from the display's back panel.



3. Carefully raise the top side of the display and disconnect the inverter cable (A) and remove the tape holding down the TMDS cable (B).



4. Raise the display a bit more to access the TMDS display connector located behind the black tape. Peel back the black tape.



5. Disconnect the TMDS display connector by squeezing the clip (1) on each side of the connector. Gently pull the cable (2) out of the slot.

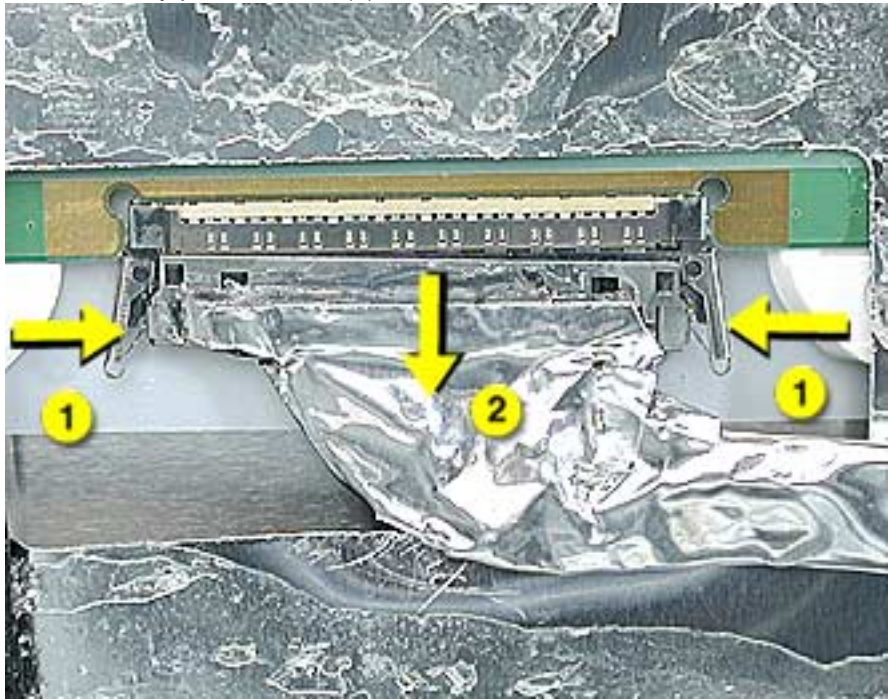

6. Raise the panel all the way up. Disconnect the power on LED cable (A) and the microphone cable (B). Set the rear housing/shield aside.

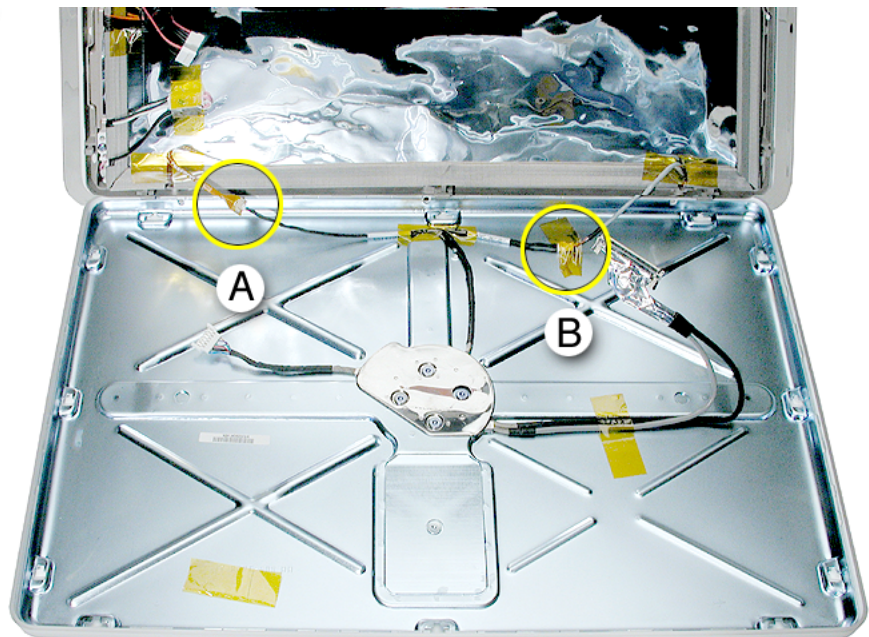

7. Remove four screws that connect the LCD display panel to the display bezel. Also, remove the kapton tape to release the inverter cables on the left side, and the LED and microphone cables from the bottom edge of the LCD display.



8. Lift the display panel out of the display bezel.
9. Remove the inverter from the display if you are returning the flat panel display to Apple. Refer to the “Inverter, 17” Display” take apart procedure in this chapter for instructions.
Replacement Note: If you are replacing the display, be sure to install the display shield and EMI gaskets (076-0958) that come with the new LCD panel. Installation instructions are included with the new display panel.

Replacing the 17" Display Panel

1. After connecting the display cables, position the display into the rear housing. Place the display into the rear housing, sliding it into position, pushing it in the direction of the arrows. **Note:** The display mates with tabs/slots in the rear housing. If the display doesn't fit properly and you can't install the three screws along the bottom of the housing, check that the display is properly seated in the rear housing.



2. Holding onto the display, turn it over and lay the display face down on a soft cloth. Push the rear housing in the direction of the arrows. This will mate the housing and display tabs.

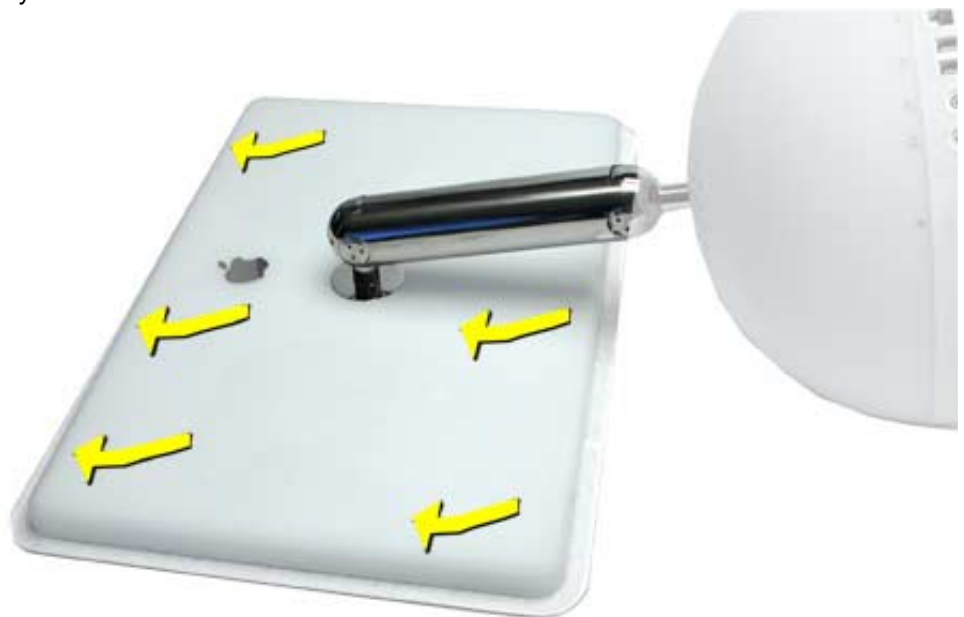

-
3. Check the alignment of the rear housing and the flat panel display. If the display doesn't slide into the tabs/slots on the rear housing, a white line shows across the back of the rear housing (see below).



4. A properly installed display will have no white line showing across the back of the rear housing (see below), and the three display-to-housing screw holes align perfectly.





Display, 15" Flat Panel

Tools

This procedure requires the following tools:

- 1.5 mm hex tool
- Plastic stylus to lift the panel

Part Location



Preliminary Steps

Before you begin, do the following:

- Position the computer in the service stand.

Procedure

1. Remove ten screws connecting the back cover to the flat panel LCD display.



2. It is not necessary to remove the two screws circled below unless you are removing the neck or the panel shield.



3. With a plastic tool, raise the display to access cables underneath the flat panel.



4. Disconnect the inverter cable shown below.



5. Raise the display to disconnect the circled items: The inverter cable, the microphone, and the power-on LED.

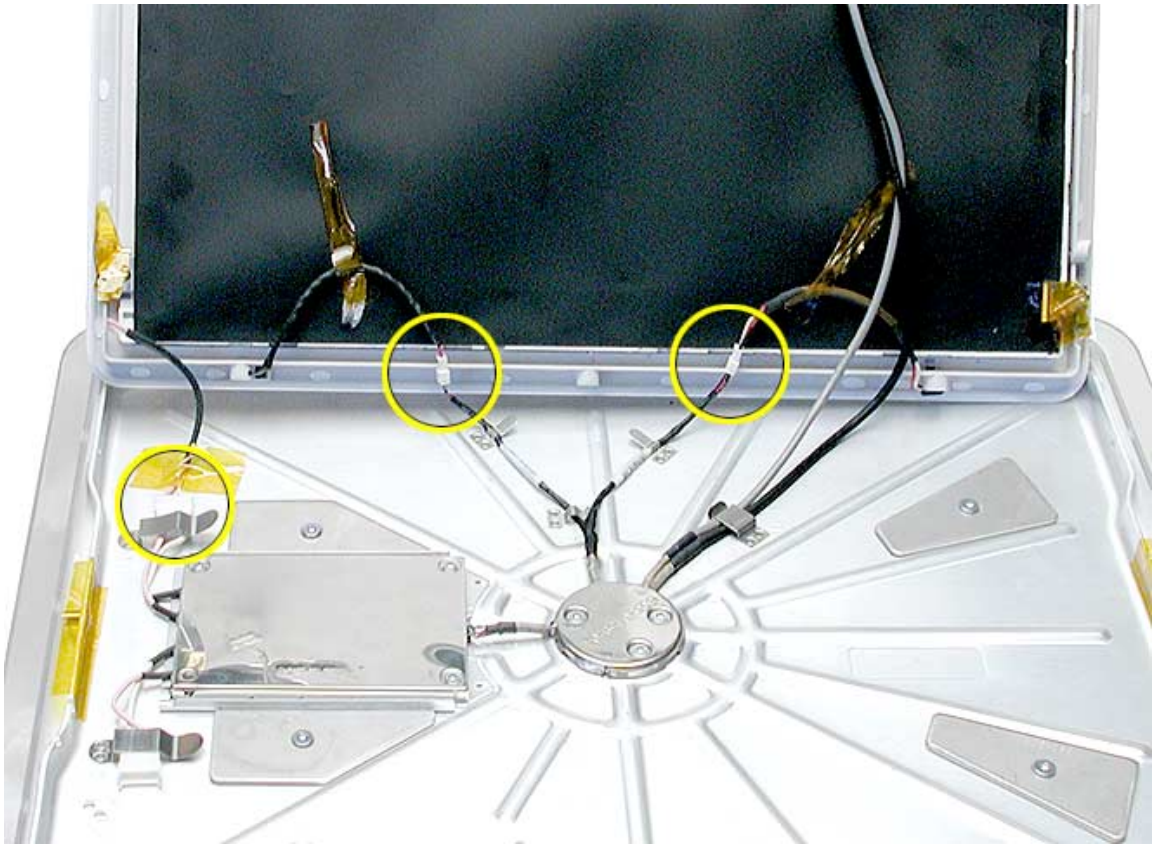

- This shows a close up of the video cable, ferrite bead, and video cable clip. After removing the kapton tape, carefully use a screwdriver to pry the ferrite bead from the video cable clip. Pry the ferrite bead from the side or from the back. **Note:** The ferrite bead is fragile and could break if a screwdriver is placed in the middle of the ferrite bead and is used as leverage to remove the bead.

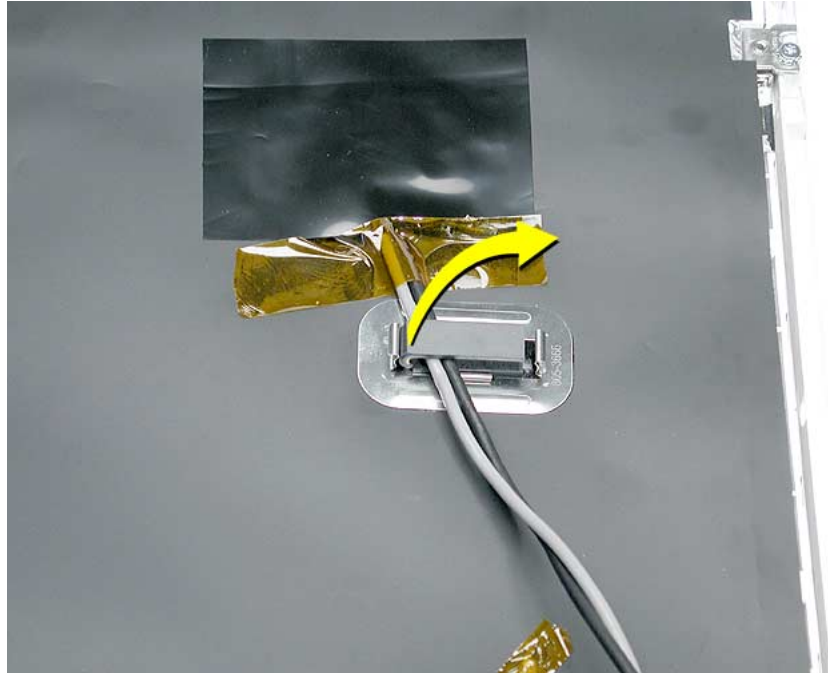

- Peel the black tape back to expose the video cable. Gently pull the video cable from the connector.

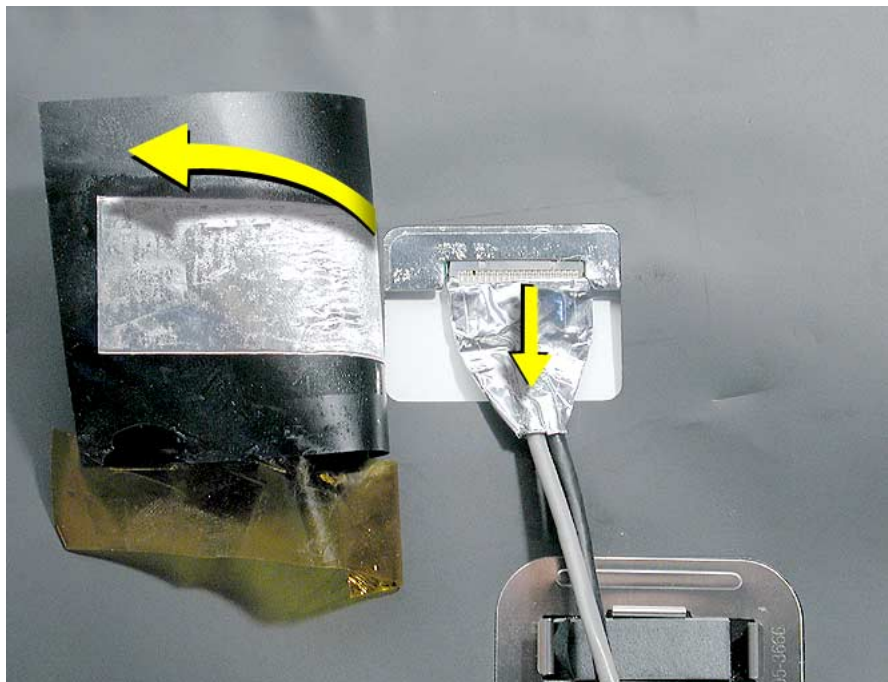

-
8. After disconnecting all the cables, you are left with the 15" LCD flat panel service part (661-2582).

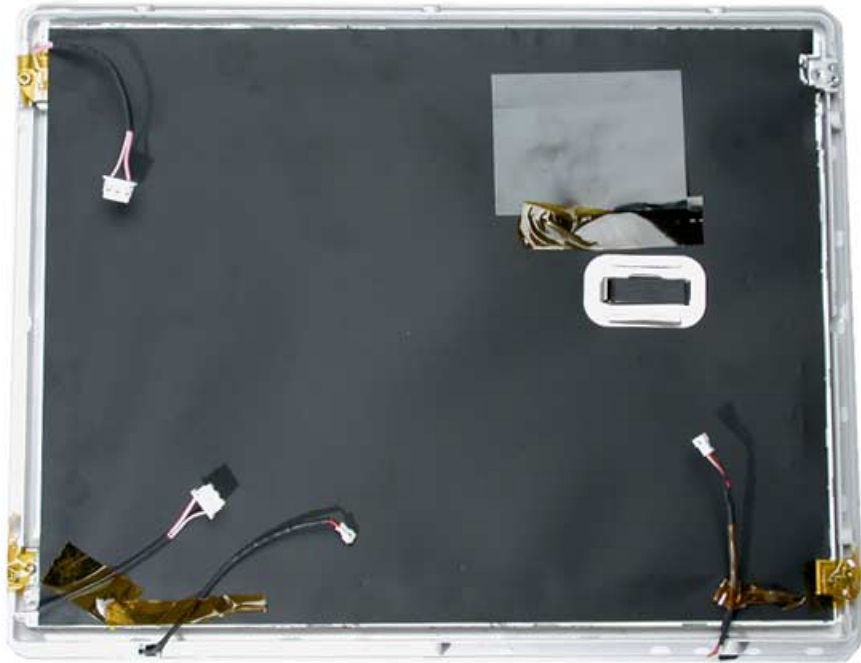



Inverter, 17" Display

Tools

No tools are required.

Part Location



Preliminary Steps

Before you begin, do the following:

- Position the computer in the service stand.
- Remove the flat panel display.

Procedure

1. Remove the four panel screws (circled below) to access the inverter on the left side of the panel.



2. Remove the kapton tape holding the cables in place.



3. Peel the foil (A) back to access the inverter. Gently pull the inverter (B) off the edge of the display panel.

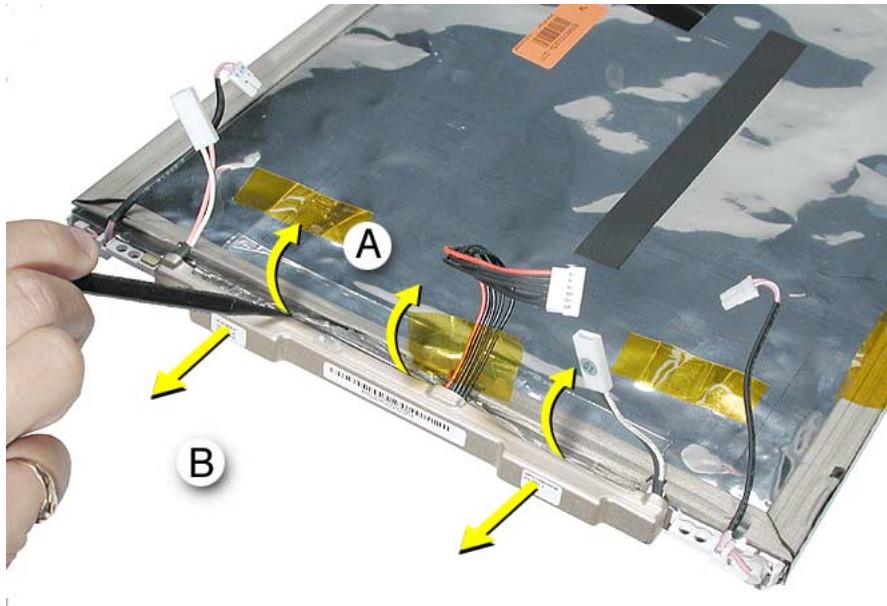



Inverter, 15" Display

Tools

This procedure requires the following tools:

- Torx-8 screwdriver

Part Location



Preliminary Steps

Before you begin, do the following:

- Position the computer in the service stand.
- Remove the flat panel display.

Procedure

1. Remove the three screws. Remove the inverter cables from the cable clip. Slide the inverter in the direction of the arrow.



2. Turn the inverter over and disconnect the third inverter cable.



3. Remove the inverter from the panel shield.



Panel Shield, 15" Display

Tools

This procedure requires the following tools:

- Torx-8 screwdriver
- Torx-10 screwdriver

Part Location

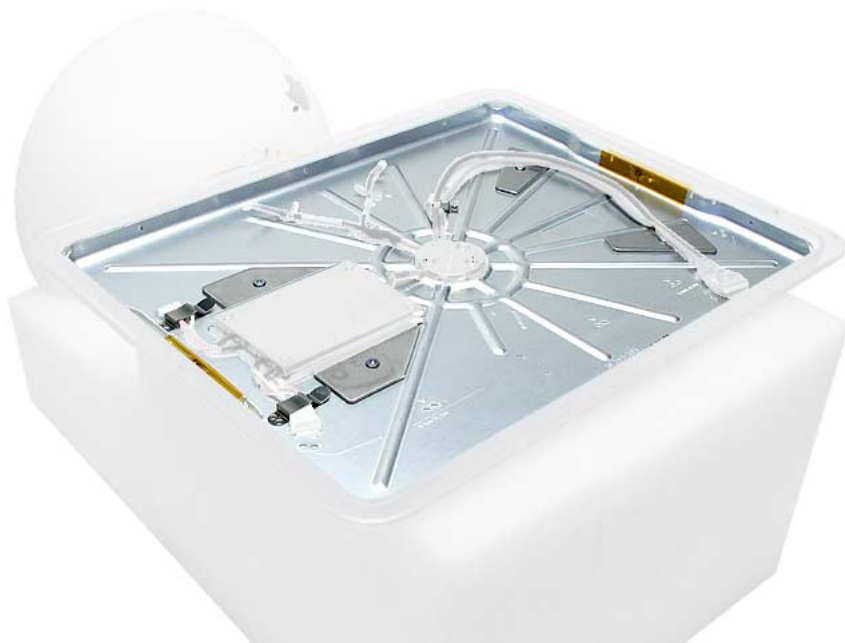

Preliminary Steps

Before you begin, do the following:

- Position the computer in the service stand.
- Remove the flat panel display.

Procedure

1. Remove the three T-8 screws on the metal cable retainer. Lift the cable retainer off the panel shield.

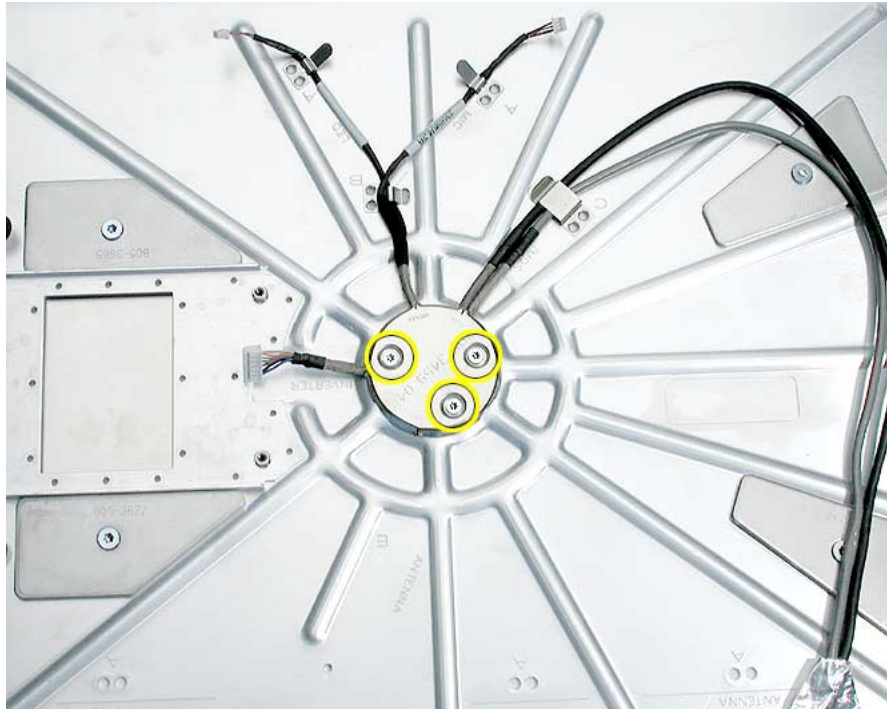

2. Remove the four T-10 screws in the center of the panel shield. Next, release the cables from the metal clips on the panel shield.

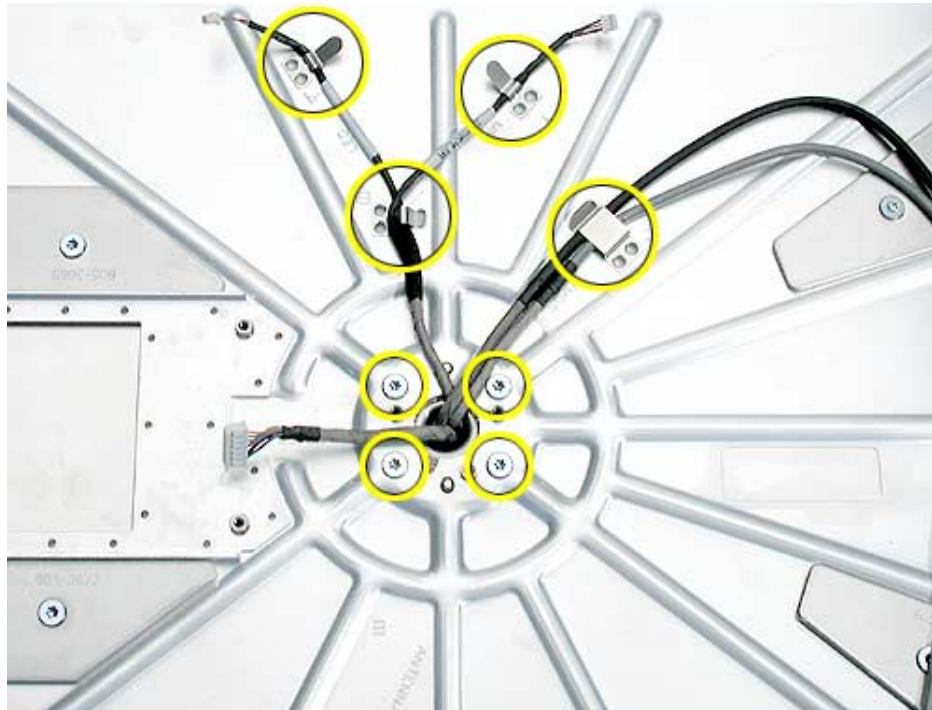

3. Remove the side screws, then gently maneuver the cables through the hole in the center of the panel shield.

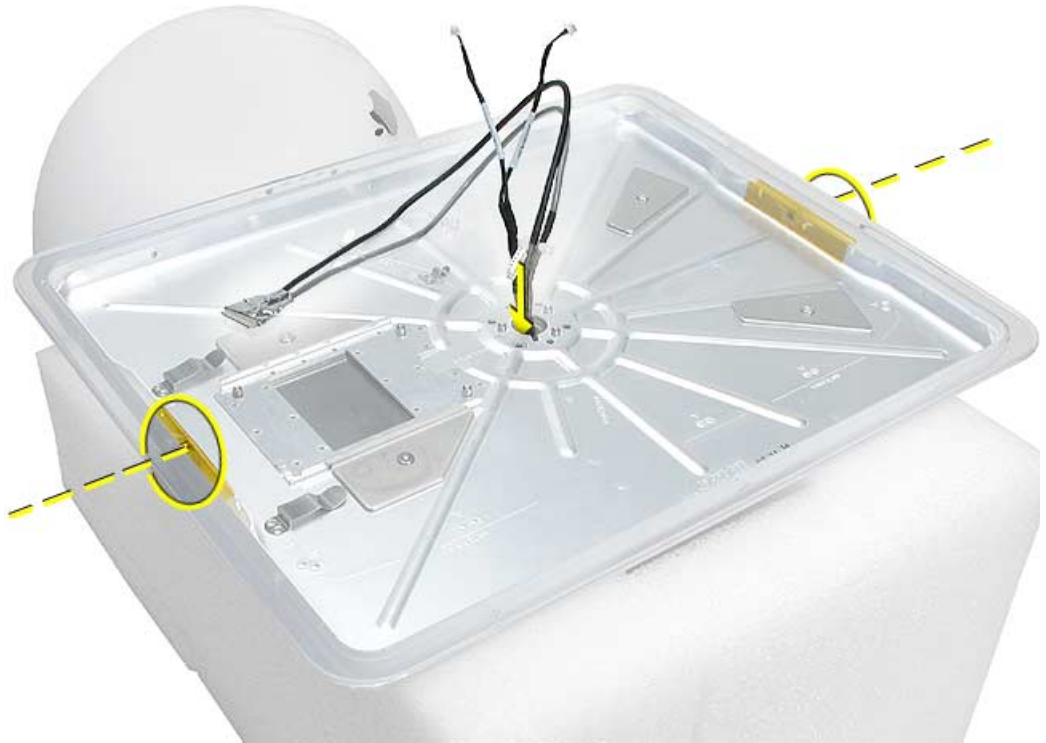

- Lift the shield off the back cover being careful not to scratch the white coating on the back cover.

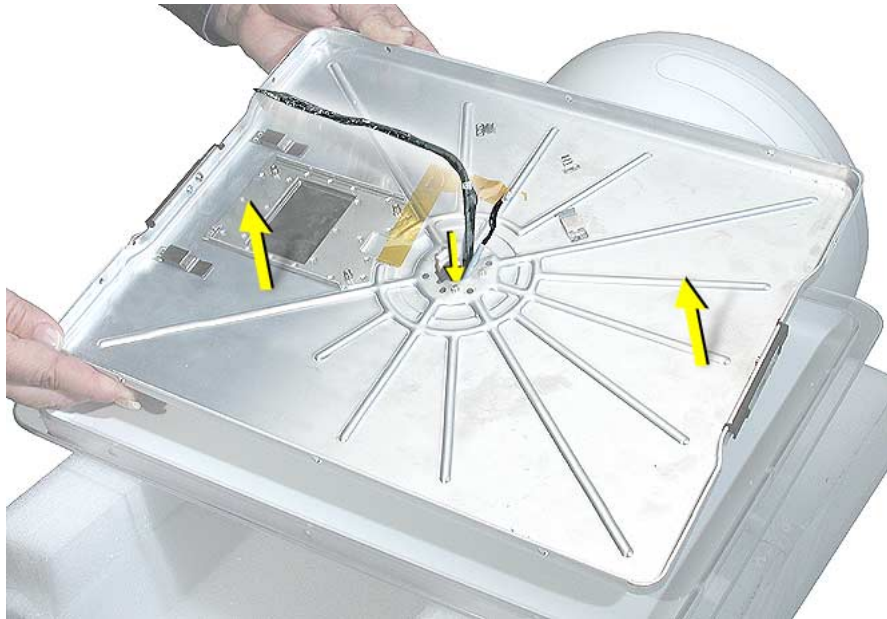

- This is a close-up of the video cable going through the hole in the panel shield.





LED, 17" Display

Note: Do not remove the LED from the bezel. The LED is part of the 17-inch display bezel (922-5297); it cannot be ordered separately.

Important: The LED does not light up when the power is on; however, the LED should pulse when the computer is in Sleep mode.

Part Location

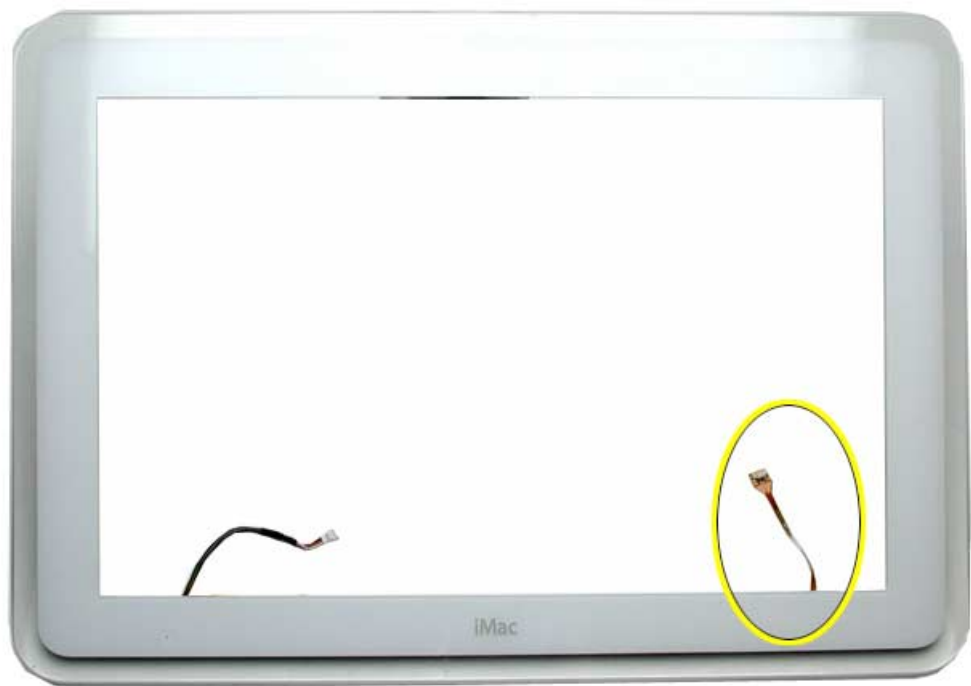

Preliminary Steps

Before you begin, do the following:

- Remove the flat panel display.



Microphone, 17" Display

Note: Do not remove the microphone from the bezel. The microphone is part of the 17-inch display bezel (922-5297); it cannot be ordered separately.

Part Location



Preliminary Steps

Before you begin, do the following:

- Remove the flat panel display.



Back Cover, 17" Display

Tools

This procedure requires the following tools:

- Torx-10 screwdriver

Part Location



Preliminary Steps

Before you begin, do the following:

- Position the computer in the service stand.
- Remove the flat panel display.

Procedure

1. Note the location of the inverter (A), TMDS (B), microphone (C), and LED (D) cables. Remove four screws that secure the metal wire deflector and the base assembly to the back cover. Remove the metal wire deflector.

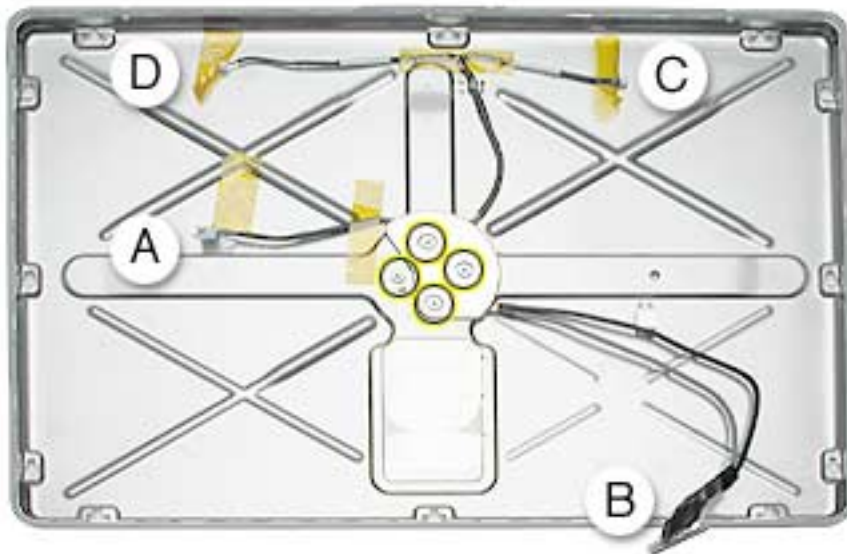

2. Remove the tape from the neck cables. Pull the cables through the hole in center of the back cover. **Note:** The hole in the back cover is notched; align the wide TMDS connector with the notches.

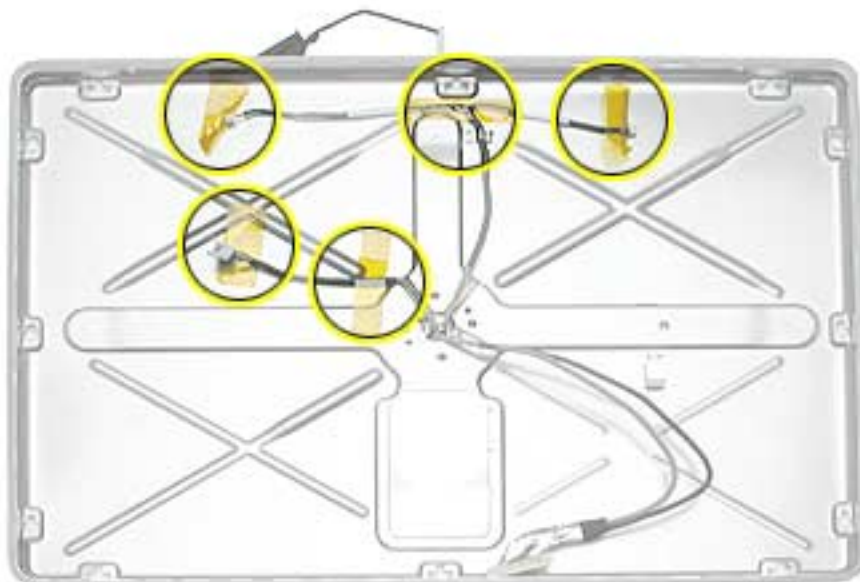



Back Cover, 15" Display

Tools

No tools are required.

Part Location



Preliminary Steps

Before you begin, do the following:

- Position the computer in the service stand.
- Remove the flat panel display.
- Remove the panel shield.

Procedure

1. Lift the display cover off the neck assembly.





Neck Assembly, 17" Display

Tools

This procedure requires the following tools:

- Torx-10 screwdriver

Part Location



Preliminary Steps

Before you begin, do the following:

- Position the computer in the service stand.
- Remove the user access plate.
- Remove the bottom housing.
- Remove the drive carrier assembly.
- Remove the power supply.
- Remove the power supply insulators.
- Remove the fan.

- Remove the fan bracket.
- Remove the neck spoke retainer cap.
- Remove the blind mate connector screws.
- Remove the Faraday cage.
- Remove the outer plastic housing.
- Remove the flat panel display.
- Remove the back cover

Procedure

1. The neck assembly is attached to the computer base at one end and to the flat panel display at the other end.
2. To remove the neck assembly from the computer, follow the complete take-apart procedure. When you are finished, you will be left with the iMac (USB 2.0) neck assembly (661-2825) shown below. The same neck is used in the iMac (17-inch, 1GHz) computer. The connector (circled) is one way to tell the difference between the older and newer neck extensions.



iMac (17-inch Flat Panel) Neck Assemblies

There are three iMac 17-inch flat panel computer models (the 800 MHz, the 1GHz, and the 1.25GHz). The 800 MHz model uses neck extension 661-2716 and the 1GHz and 1.25GHz models use the same neck assembly, part number 661-2825.

Picture A below shows the neck extension (661-2716) from the original iMac (17-inch Flat Panel) model; it has the blind mate connector (circled). The newer neck extension (661-2825) does not have the blind mate connector (see the next picture).



Picture B below shows the newer neck extension, 661-2825. This neck is used on the iMac (17-inch Flat Panel, 1 GHz) and the iMac (USB 2.0) models.





Neck Assembly, 15" Display

Tools

This procedure requires the following tools:

- Torx-10 screwdriver

Part Location



Preliminary Steps

Before you begin, do the following:

- Position the computer in the service stand.
- Remove the user access plate.
- Remove the bottom housing.
- Remove the drive carrier assembly.
- Remove the power supply.
- Remove the power supply insulators.
- Remove the fan.

-
- Remove the plastic cable retainer (under the fan).
 - Remove the cap spoke holder.
 - Remove the blind mate connector screws.
 - Remove the Faraday cage.
 - Remove the flat panel display.
 - Remove the panel shield.
 - Remove the back cover

Procedure

The neck assembly (661-2969) for the 15-inch iMac (USB 2.0) model is shown below. It is attached to the computer base at one end and to the flat panel at the other end. To remove the neck assembly from the computer, follow all the take-apart procedures listed above. When you are finished, you will be left with the neck assembly shown below.

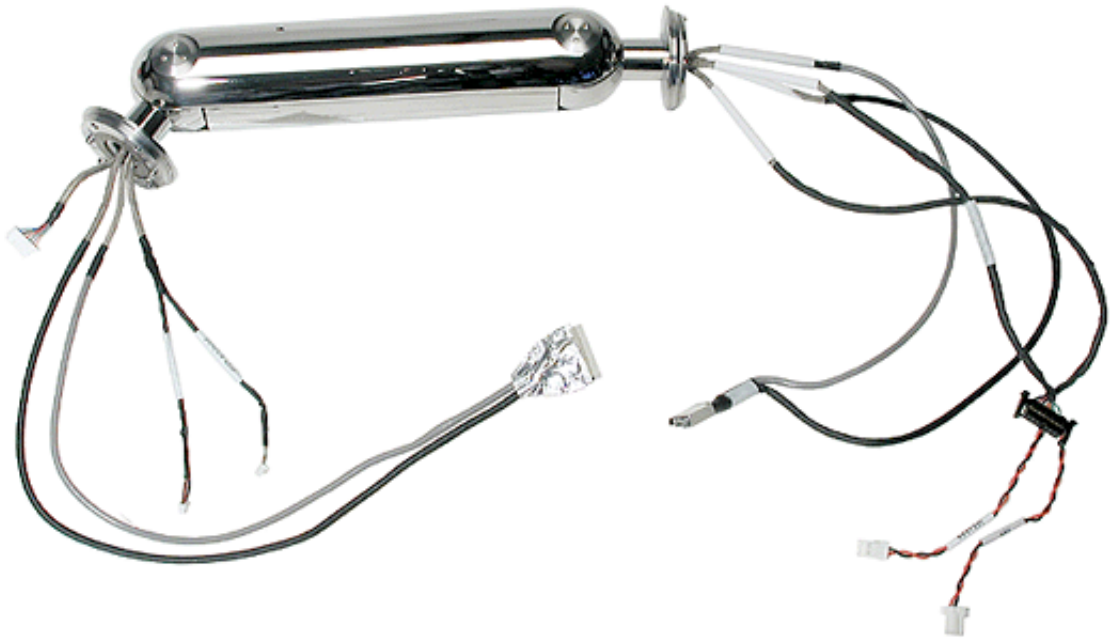



Troubleshooting
iMac (USB 2.0)



General Information

Overview:

How do you identify these models from the earlier iMac (Flat Panel) models?

1. Identify the processor speed. If the system is up and running, select “About this Mac” under the Apple icon in the Finder. Or, select the “More Info” button on the “About this Mac” window. Apple System Profiler opens and displays the machine speed under “Hardware Overview.” The 15-inch iMac has a 1GHz PowerPC G4 processor and the 17-inch iMac has a 1.25GHz PowerPC G4 processor.
2. These computer models use double-data rate (DDR) memory; PC2700 DDR333. Memory from previous iMac models is not compatible with this computer. Do not use older SDRAM DIMMs or SO-DIMMs even if they fit into the slot. Make sure to use PC2700 DDR333 low profile SO-DIMMs in the user-installable slot. The iMac memory pinouts are 184-pin internal, and 200-pin on the user-installable slot.

Important Things to Remember:

Service items that still apply to all flat-panel iMac computers:

1. Diagnostic test points are on to the logic board. They are accessed through the user access door. Use the test points to check the following:
 - Battery
 - 5V
 - 12VSLP
 - 12V

For more information, refer to the “Logic Board Battery” and “No Power” topics later in this chapter.

2. **Important:** The CPU uses a thermal pipe to transfer heat away. This pipe makes a thermal connection to the top metal chassis (Faraday cage) at **two** locations. These connecting points must be cleaned and have new thermal paste applied each time the bottom housing is removed. If the mating surfaces are not cleaned and thermal paste is not used, the CPU may overheat and become damaged. There is no exception to this. **Note:** Most service procedures require that the bottom housing is removed.

Refer to “Thermal Paste Application” mentioned later in this chapter or in the Take Apart chapter.

3. Whenever the 17-inch LCD display (661-2715) is replaced, a display shield/gasket kit (076-0958) must be installed on the new panel. Instructions for installing the shield/gasket kit are included with the new LCD panel.
4. The LED and microphone are part of the 17-inch display bezel (922-5297); they cannot be ordered separately.
5. The LED functions differently on the iMac (17-inch Flat Panel). The LED **does not** light up when the

power is on; however, the LED should pulse when the computer is in Sleep mode.**Important:** If you are replacing the display, be sure to install the new display shield and EMI gaskets that come with the new LCD panel. Installation instructions are included with the new display panel. Additional display shields/gasket kits are also available separately as a kit, part number 076-0958.

6. **Important:** Whenever the logic board is separated from the bottom housing, you must install new thermal pads to two surfaces on the bottom housing. The thermal pads help cool components on the logic board. Failure to apply these pads whenever the logic board is separated from the bottom housing could cause these parts to overheat. Short term separation, where the thermal pads are not handled excessively (an exception would be if you are simply testing the logic board and only detach it for a few minutes), does not require replacement. Refer to “Thermal Pad Installation” in this chapter for detailed information.

Refer to the Take Apart chapter, “Thermal Pad Installation.”

7. Whenever the bottom housing is opened for service, you must do two things:
 1. You must clean the original thermal film from the surfaces joining the thermal interface layer and reapply thermal paste to the thermal pipe.
 2. You must tighten the four torx screws on the bottom housing to a minimum of 17 in.-lbs. If you do not have a torque driver, you will have to make sure these screws are tightened by hand FIRMLY, BUT NOT FORCIBLY. Or, purchase the service tool (076-0899) in order to ensure the thermal pipe is firmly mated with the top base. If the bottom housing is not securely attached to the base in this fashion, the CPU may overheat and become damaged. Failure to follow either of these steps could cause the computer to overheat and damage internal components.

Refer to the topic, “Thermal Paste Application” for detailed information.

8. A service stand, 076-0898, is available from Apple Service to hold the unit while you service the computer.

Logic Board, Top

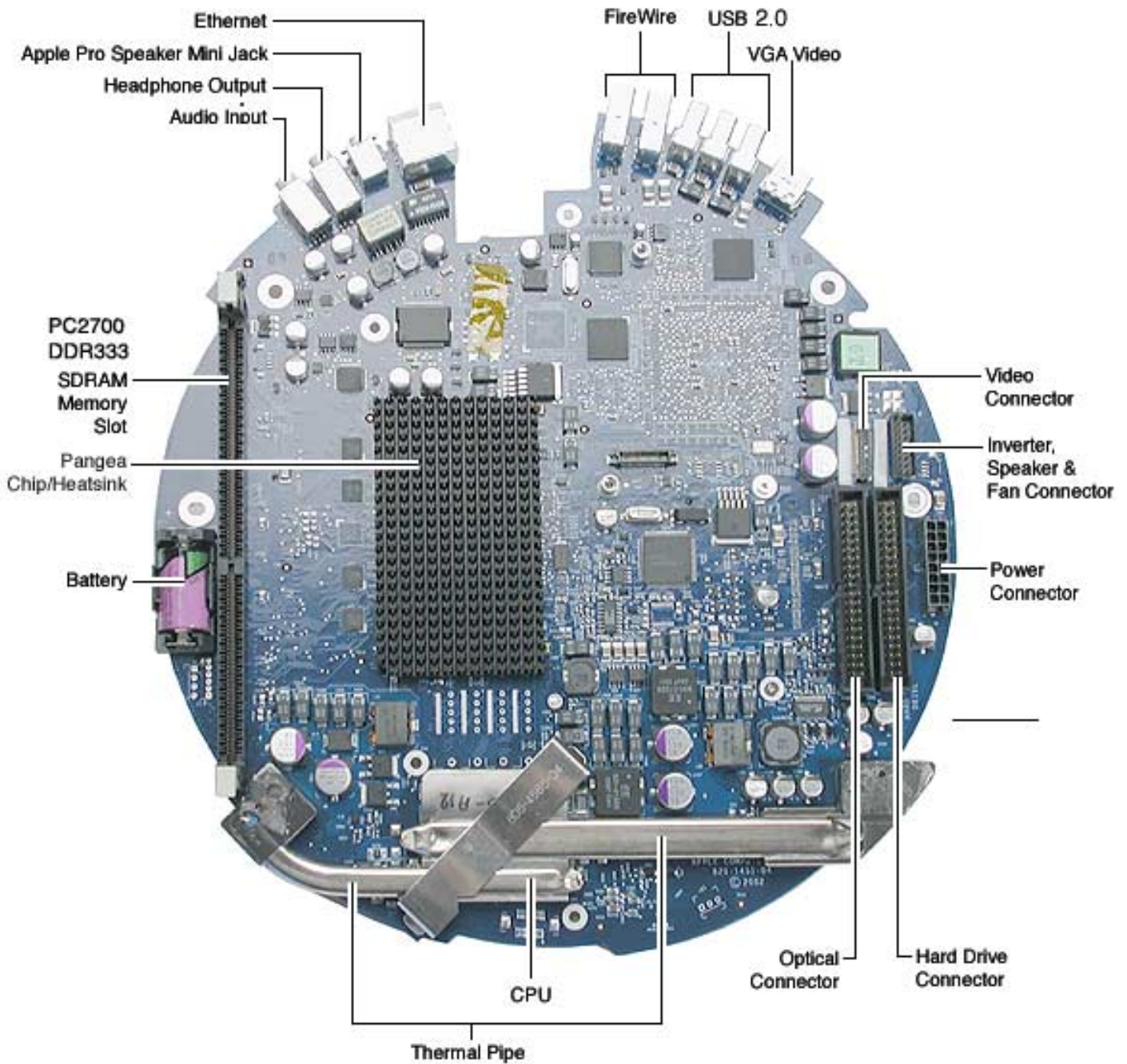

Logic Board, Bottom

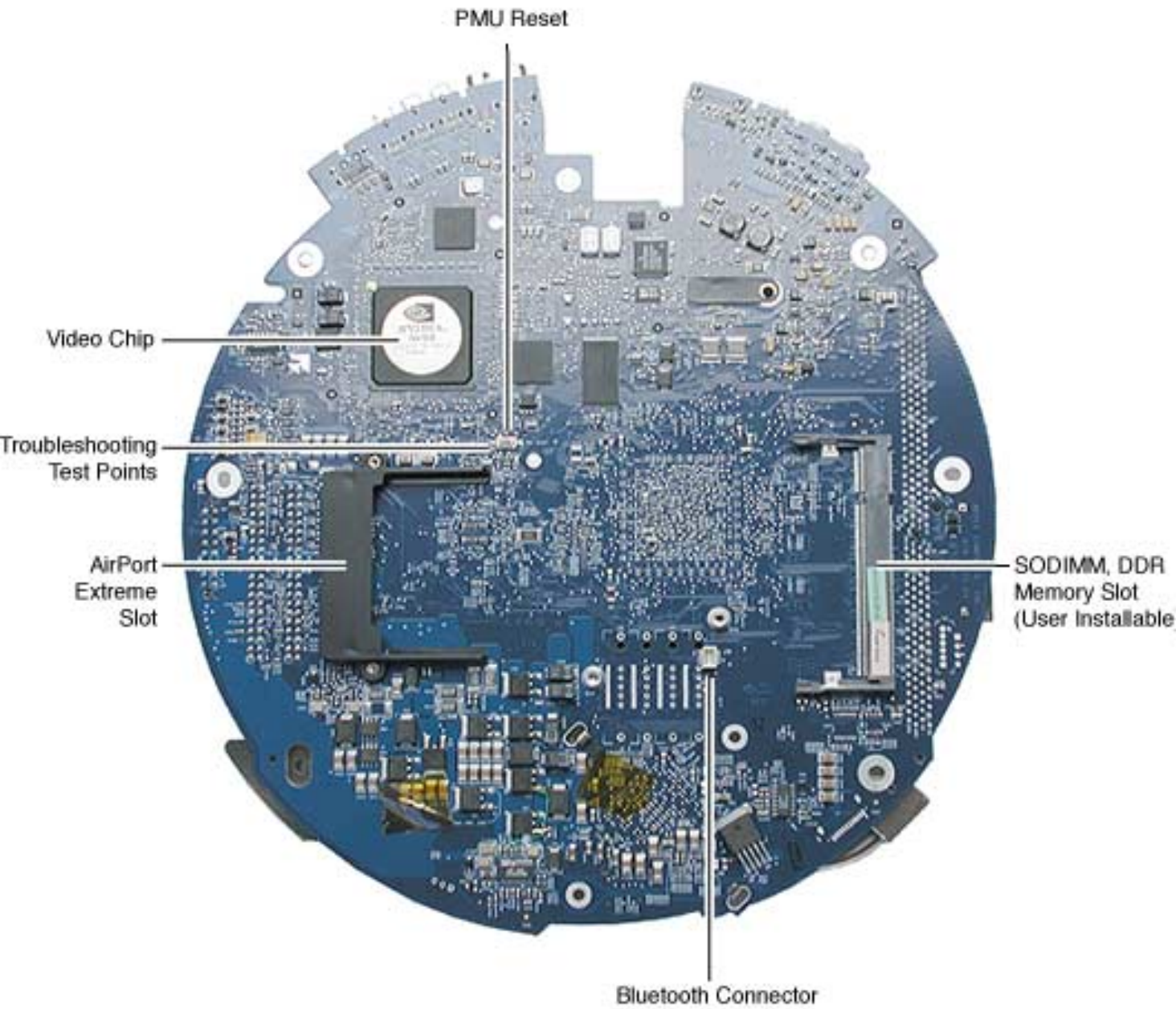

I/O Ports



The PMU Chip

The PMU (Power Management Unit) is a microcontroller chip that controls all power functions for the computer. The PMU (location shown below) is a computer within a computer. It has memory, software, firmware, I/O, two crystals, and a CPU. Its function is to:

- Tell the computer to turn on, turn off, sleep, wake, idle, etc.
- Manage system resets from various commands.
- Maintain parameter RAM (PRAM).
- Manage the real-time clock.

Important: The PMU is **very** sensitive and touching the circuitry on the logic board can cause the PMU to crash. If the PMU crashes, the battery life goes from about five years to about two days if the PMU is not reset. Refer to the next topic, “Resetting the PMU on the Logic Board” for the procedure.

Many system problems can be resolved by resetting the PMU chip.



Location of the PMU Button

Resetting the PMU on the Logic Board

Resetting the PMU (Power Management Unit) on the logic board can resolve many system problems. Whenever you have a unit that fails to power up, you should follow this procedure before replacing any modules.

1. Disconnect the power cord.
2. Remove the user access panel from the bottom of the computer.
3. Press the PMU reset switch (located under the protective cover, next to the test points) once on the bottom side of the logic board and then proceed to step 3. Do **NOT** press the PMU reset switch a second time because it could crash the PMU chip.

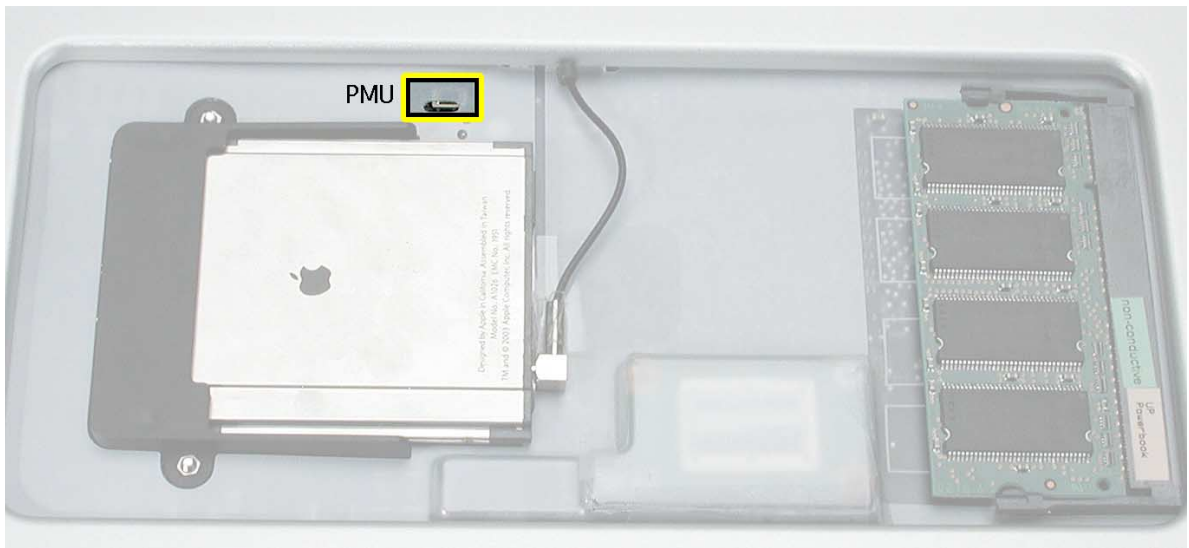

4. WAIT ten seconds before connecting the power cord and powering the computer on. If the computer powers on, go to the next step. If the computer does not power on, there is something else wrong with the computer, refer to the symptom/cure, “No Power” in this chapter.
5. Run Apple Service Diagnostic or Apple Hardware Test for the iMac (USB 2.0) models and return the computer to the customer.

Note: This entire procedure resets the computer’s PRAM. Be sure to reset the computer’s time, date and other system parameter settings before returning the computer to the customer.

Diagnostic Test Points

The iMac has four test points and one ground pad on the bottom of the logic board. These test points are accessible under the customer access panel via small cutouts in the plastic shielding (see below).



These test points provide an easy troubleshooting tool for common problems. To use each test point, put the positive probe of your voltmeter on the test point, and the negative probe on the ground pad.

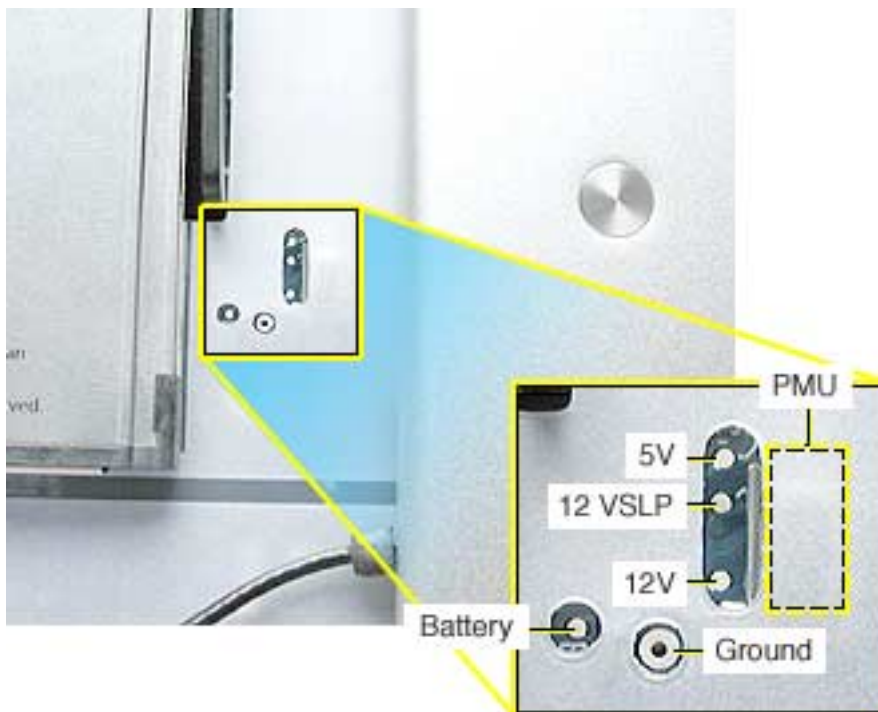

Logic Board Battery

Important: Apple highly recommends removing the battery when handling the logic board. Make sure to use proper ESD protection when handling modules.

The battery on the logic board controls the stored system settings, such as date and time. It is only necessary to test the battery when you can't power on the computer, or the date and time are reset every time the AC power is removed.

The battery is also used to power the PMU chip (because the PMU chip keeps time and must always be running) when the computer is unplugged from the wall (AC power). The PMU is **very** sensitive and touching any circuitry that is connected to the PMU can cause it to crash. If the PMU crashes, the battery life goes from about five years to about two days if the PMU is not reset. Once the battery goes dead, the PMU will reset the time and date every time the AC power is removed. To fix this situation, replace the battery and reset the PMU (refer to "Resetting the PMU on the Logic Board" mentioned earlier in this chapter).

If the computer has a "No Power" situation, check the battery before replacing modules.

Testing the Battery

1. Remove the user access door on the bottom of the computer.
2. Locate the battery test point.

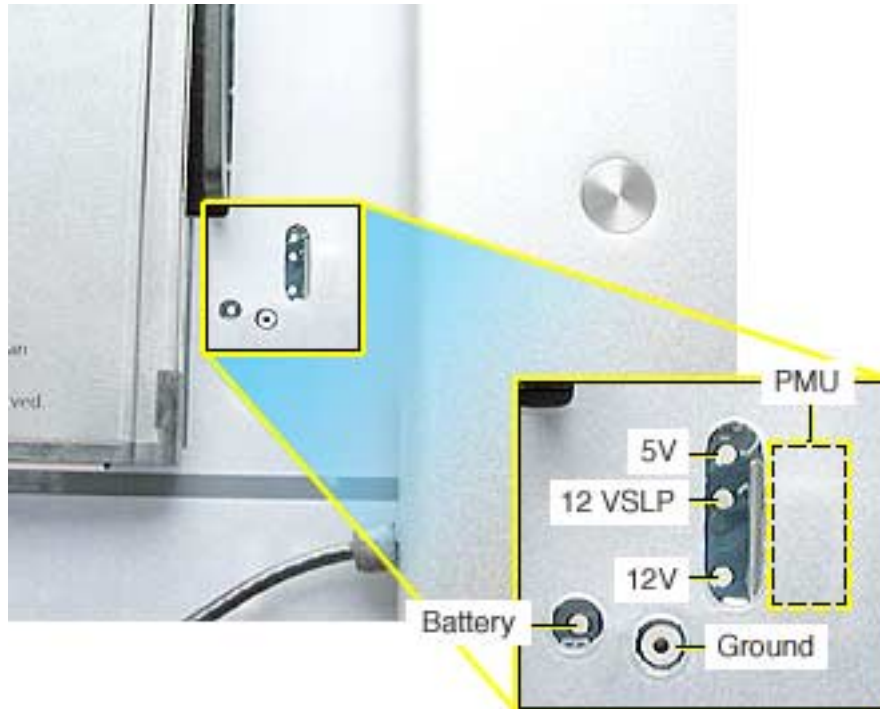

3. With the computer powered off, measure the battery voltage. Does the battery measure at least +3.5v? If no, replace the battery and reset the PMU. If the battery measures +3.5v or higher, reinstall the battery and reset the PMU as above.

4. Connect the power cord and power up the system again.

Warning: Whenever the bottom housing is opened for service, you must do two things:

1. You must clean and reapply thermal paste to the thermal pipe surface.

2. You must tighten the four torx bolts on the base unit to a minimum of 17 in.– lbs. Failure to follow either of these steps could cause the computer to overheat and damage internal components.

Refer to the next topic, “Thermal Paste Application” for detailed information.

Thermal Paste Application

The following instructions explain how to apply thermal paste to the thermal pipe in the iMac (USB 2.0) computer. Failure to follow these instructions could cause the computer to overheat and damage internal components.

Tools

This procedure requires the following tools:

- Plastic stylus or plastic spatula to remove the old thermal paste
- Plastic stylus or plastic spatula to spread the thermal paste
- Thermal paste (922-4757)

Paste Location

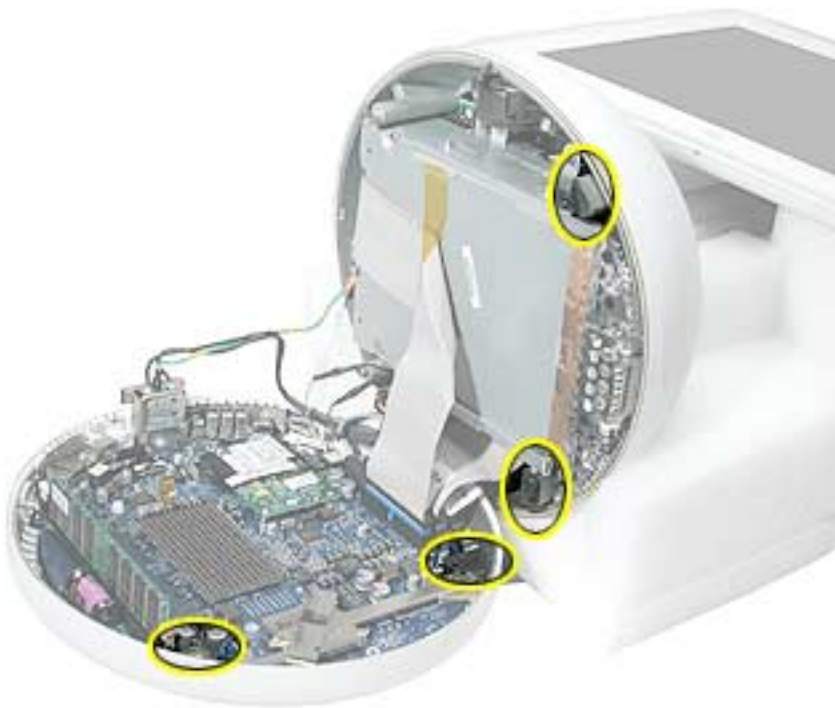

Procedure

1. Thoroughly clean the original thermal film from the four mating surfaces circled below. Use a plastic stylus to scrape the surfaces clean. **Note:** Do not use an abrasive material or liquid cleaner.



2. Squeeze a drop of thermal paste onto the thermal pipe locations circled below.

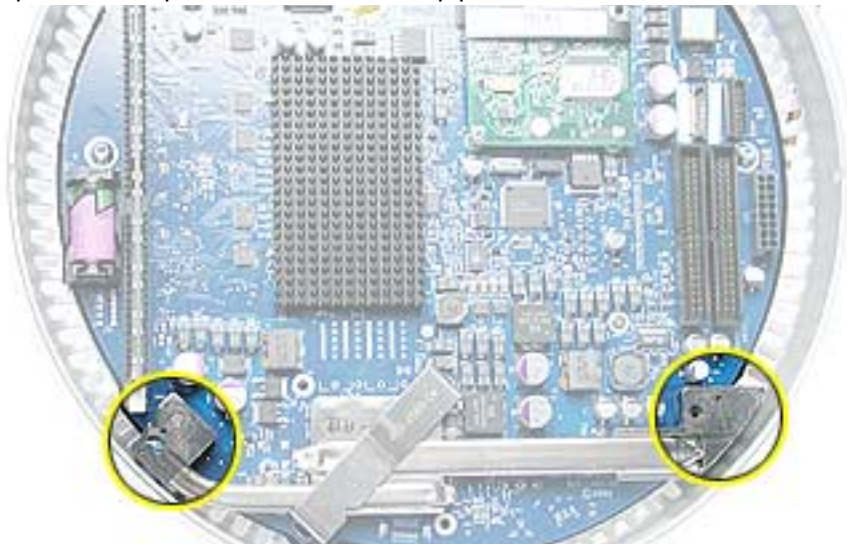

3. Close the bottom housing.
Warning: The bottom housing has four torx screws that must be tightened to at least 17 in.-lbs. If you do not have a torque driver, you will have to make sure these screws are tightened by hand **FIRMLY, BUT NOT FORCIBLY**. Or, purchase the service tool (076-0899) in order to ensure the thermal pipe is firmly mated with the top base. If the bottom housing is not securely attached to the base in this fashion, the CPU may overheat and become damaged.

Thermal Pad Replacement Instructions

Whenever the logic board is separated from the bottom housing, you must install new thermal pads to three surfaces on the bottom housing. The thermal pads help cool components on the logic board. Failure to apply these pads whenever the logic board is separated from the bottom housing could cause these parts to overheat. Short term separation, where the thermal pads are not handled excessively (an exception would be if you are simply testing the logic board and only detach it for a few minutes), does not require replacement.

Procedure

1. Remove the old thermal pads (circled below) from the bottom housing. Thoroughly clean the bottom housing surfaces after removing the pads. **Note:** If you don't see all three thermal pads on the bottom housing, check the bottom side of the logic board.



2. Using the thermal pad kit, remove the clear protective backing from the new thermal pads.
3. Place the new thermal pads in the bottom housing. **Note:** Avoid unnecessary contact with either side of the thermal pad as dirt and body oils reduce the thermal pad's conductivity.
4. Press down on the blue protective backing to make sure each thermal pad has even contact with the bottom housing. There should be no air pockets.
5. Remove the blue protective backing from the new thermal pads.
6. Replace the logic board. Holding the logic board by the battery retainer and the internal drive cable connector, slide the logic board back into the bottom housing (make sure the I/O port covers are on the logic board).



Symptom Charts

How to Use the Symptom Charts

The Symptom Charts included in this chapter will help you diagnose specific symptoms related to the product. Because cures are listed on the charts in the order of most likely solution, try the cures in the order presented. Verify whether or not the product continues to exhibit the symptom. If the symptom persists, try the next cure.

Note: If you have replaced a module, reinstall the original module before you proceed to the next cure.

Apple Hardware Test

Apple Hardware Test is a diagnostic tool for detecting problems with Apple internal hardware components such as logic board, memory, modem, video RAM, and Apple AirPort Card. The test does not check externally connected hardware components such as USB or FireWire devices; it also does not check non-Apple devices such as third-party PCI cards.

Note: The most recent Apple Hardware Test software can be downloaded from the CD Images page on AppleCare Service Source; go to the Service Source home page and select 'Disc Images' from the quick-click table.

Error Codes

If Apple Hardware Test detects a problem with a computer, it displays an error code, which is defined in the product's Error Code List. Consult the list for appropriate repair procedures associated with the code.

All Error Code Lists are included in the Service Diagnostics Matrix, Knowledge Base article 112125. You can also access this matrix by clicking the Service Diagnostics rollover link under any of the product areas on the Service Source home page.

No Power

No fan, no hard drive noise, and the screen is black.

1. Verify the power outlet is good. Plug a different device into the socket to ensure there is power, or plug computer into another outlet.
2. Check the power cord. Use a known good power cord.
3. Check connection of the power cord on both ends. Verify that the plug is securely plugged into both the A/C outlet and back of the computer.
4. Remove keyboard, mouse, and other peripherals such as speakers.
5. Disconnect the power cord, place the computer in the service stand, and remove the user access plate.
6. Reset PMU. Refer to “Resetting the PMU on the Logic Board” mentioned earlier in this chapter.
7. Using a voltmeter, check the voltage on the battery test point (see graphic below). If the reading is over 3.5 volts, go to the next step. If the reading is under 3.5 volts, replace the battery and test again.

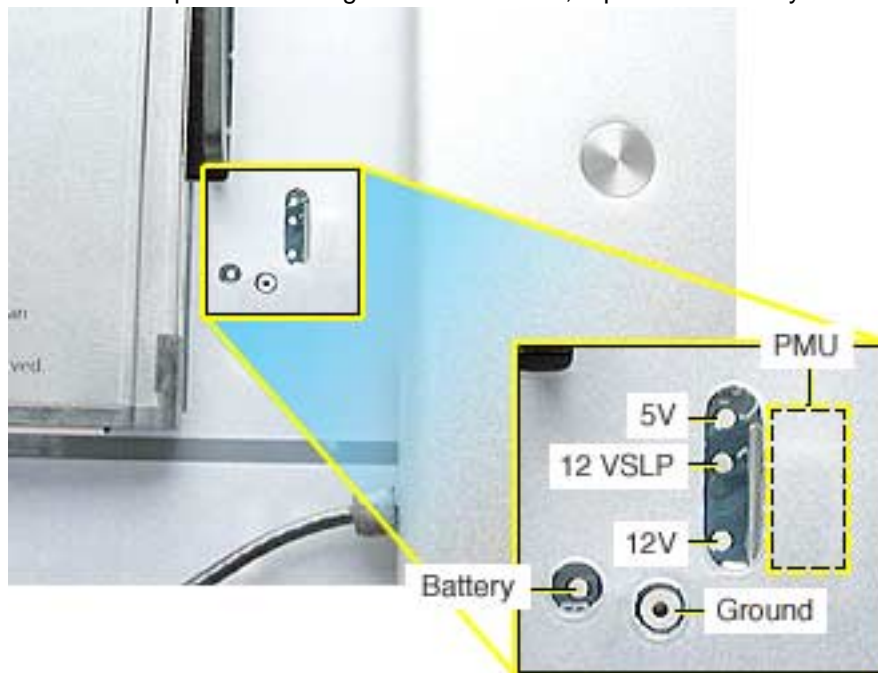

8. Plug the unit in, but do **NOT** press the power button. Using a voltmeter, check the voltage from the test point marked “12VSLP” (see graphic above). You should get a reading of approximately 12 volts. If the reading is 12 volts, go to the next step. If you don’t get a 12 volt reading, go to step 11.
9. Press the power switch on the computer. Using a voltmeter, check the voltage on the test point marked “12V” (see graphic above). You should get a reading of approximately 12 volts. If the reading is 12 volts, go to the next step. If you do not get a 12 volt reading, replace the main logic board.
10. Using a voltmeter, check the voltage on the test point marked “5V” (see graphic above). You should get a reading of approximately 5 volts. If the reading is 5 volts, go to the next step. If you do not get a 5 volt reading, replace the main logic board.

11. Remove the bottom housing. Check that all the cables on the logic board are securely connected. Pay special attention to the video connector. Power on the unit again. If you still have no power, go on to the next step.

Warning: Whenever the bottom housing is opened for service, you must do two things:

- You must clean the original thermal film from the surfaces joining the thermal interface layer and reapply thermal paste to the thermal pipe.
- The bottom housing has four torx screws that must be tightened to at least 17 in.-lbs. If you do not have a torque driver, you will have to make sure these screws are tightened by hand FIRMLY, BUT NOT FORCIBLY. Or, purchase the service tool (076-0899) in order to ensure the thermal pipe is firmly mated with the top base. If the bottom housing is not securely attached to the base in this fashion, the CPU may overheat and become damaged.

12. Check power supply output. Disconnect the power supply cable from the logic board. Measure power at the power supply connector by touching the black probe to the ground pin, and using the red probe to measure power at the pins indicated in the graphic below. Did you measure +12v at each point? If yes, replace the logic board. If no, replace the power supply.

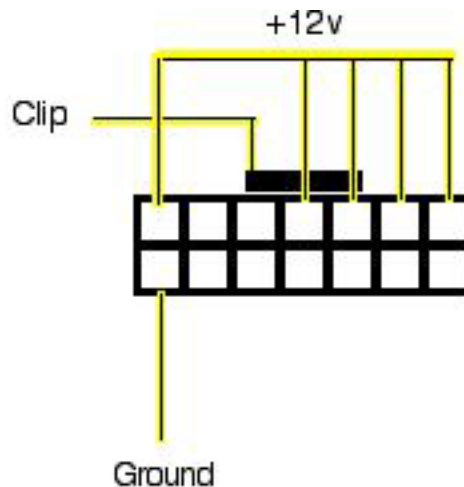

13. Replace the inverter board.

14. Replace the neck assembly.

No Video

Screen is dark, fan is running and the hard drive is spinning. You may hear the startup chime as well.

1. Reset parameter RAM. Press Command-Option-P-R during startup before “Welcome to Macintosh” appears.
2. The system software could be damaged. Start up from the system CD that came with the computer.
3. Remove the user access panel on the bottom of the computer. With the unit powered on, check if a red LED is visible in the access door. If the red LED is on, power is on. If you don’t see the LED glowing red, follow the steps under the symptom “No Power”.
4. Disconnect the A/C power cord. Place the unit in the service stand and remove the user access plate. Press the PMU reset button on the logic board. Refer to “Resetting the PMU on the Logic Board” mentioned earlier in this chapter.
5. Check for external video. Connect an external monitor to the mini-VGA port. If you don’t have external video, replace the main logic board. If you do have external video, go on to the next step.
6. Open the bottom housing and verify that all the cables are securely attached. Pay special attention to the video cable (located near the modem). If the cables are securely attached, go on to the next step.
Warning: Whenever the bottom housing is opened for service, you must do two things:
 - You must clean the original thermal film from the surfaces joining the thermal interface layer and reapply thermal paste to the thermal pipe.
 - The bottom housing has four torx screws that must be tightened to at least 17 in.-lbs. If you do not have a torque driver, you will have to make sure these screws are tightened by hand FIRMLY, BUT NOT FORCIBLY. Or, purchase the service tool (076-0899) in order to ensure the thermal pipe is firmly mated with the top base. If the bottom housing is not securely attached to the base in this fashion, the CPU may overheat and become damaged.
7. Check the connection of the video cable to the LCD flat panel display (under black tape).
8. Replace the inverter board.
9. Replace the LCD display. **Important:** If you are replacing the display, be sure to install the new display shield and EMI gaskets that come with the new LCD panel. Installation instructions are included with the new display panel. Additional display shields/gasket kits are also available separately as a kit, part #076-0958.
10. Replace the neck assembly
11. Replace the logic board.
12. Replace the power supply board.

No LED

LED on the 17-inch display bezel does not light up

Note: The LED does not light up when the power is on; however, the LED should pulse when the computer is in Sleep mode.

1. Put the computer into Sleep mode. Does the LED pulse now? If yes, there is nothing wrong with the LED. If no, replace the display bezel (922-5297). The LED is attached to the display bezel and cannot be ordered separately.



LED on the 15-inch display bezel does not light up

1. Put the computer into Sleep mode. Allow the machine to remain in sleep mode for one minute and then wake the computer to ensure the computer is waking from sleep mode. Does the LED pulse now? If yes, there is nothing wrong with the LED. If no, replace the LED (922-4702). **Note:** The LED on the 15-inch panel can be ordered separately.

Display Tilt

Screen tilts to the left or the right even after a manual adjustment.

Note: It is normal for the screen on an iMac (Flat Panel) to have a small amount of horizontal play. However, the screen should be able to be adjusted so that it will stay in a level horizontal position.

1. Remove the flat panel.
2. For the 15-inch: Remove the three screws and lift the cable retainer off the panel shield.



3. For the 17-inch: Remove the four screws and lift the cable retainer off the back panel.



4. For either size display, loosen the screws under the metal cable retainer and tilt the screen the opposite direction of the tilt. **Note:** The picture below shows the four screws on the 15-inch model; the 17-inch model looks very similar.



5. While holding the display bezel in the level position, tighten the screws.
6. Replace the panel and check that the display is now horizontally level. **Important:** If you are replacing the 17-inch display, be sure to install the new display shield and any EMI gaskets that may come with the new LCD panel.

When displaying a single color over the screen area, the LCD panel shows one or more pixels that are not properly lit

Active-matrix LCD technology uses rows and columns of addressable locations (pixels) that render text and images on screen. Each pixel location has three separate subpixels (red, green, and blue) that allow the image to be rendered in full color. Each subpixel has a corresponding transistor responsible for turning the subpixel on or off.

There are typically millions of these subpixels on an LCD display. For example, the LCD panel used in the Apple Cinema HD display is made up of 2.3 million pixels and 6.9 million red, green, and blue subpixels. Occasionally, a transistor does not work perfectly, which may result in the affected subpixel being turned on (bright) or turned off (dark). With the millions of subpixels on a display, it is quite possible to have a low number of faulty transistors on an LCD. Therefore, a certain number of subpixel anomalies is considered acceptable. Rejecting all but perfect LCD panels would significantly increase the retail price for products using LCD displays. These factors apply to all manufacturers using LCD technology—not just Apple products.

To determine whether or not the display has an acceptable number of pixel anomalies, follow the steps below:

1. Set the display image to one of the following colors: all-white display, all-red display, all-green display, or all-blue display.
2. Using a jeweler's loupe, pocket microscope, or other magnifying device, identify and count each subpixel anomaly:
 - Bright subpixel anomaly = subpixel that is always on
 - Dark subpixel anomaly = subpixel that is always off
3. **Important:** Check the number of subpixel anomalies with the following chart:

| LCD Size (inches) | Acceptable Number of Subpixel Anomalies | | | Replace the Display | | |
|-------------------|---|---------|-------------|---------------------|-----------|-------------|
| | Bright | Dark | Combination | Bright | Dark | Combination |
| 17 to 20 | up to 4 | up to 6 | up to 8 | 5 or more | 7 or more | 9 or more |

4. If the number of subpixel anomalies exceeds the acceptable number listed in the chart, replace the LCD panel.
5. If the number of subpixel anomalies is acceptable, explain to the customer that the pixel anomalies are within specifications, and no repair is necessary.

Important: Do not release the specifications to customers. Instead, inform them that a certain number of subpixel anomalies is considered acceptable, and these factors apply to all manufacturers using LCD technology—not just Apple products.

Hard Drive

Hard Drive won't mount to the desktop

1. Disconnect any connected peripherals.
2. Boot from the system CD that came with the computer and see if the hard drive mounts on the desktop.
3. Launch Drive Setup and update the hard drive driver.
4. If no hard drive is found in Drive Setup, verify the hard drive cable connections.
5. Replace the hard drive cable.
6. Replace the hard drive.
7. Replace the logic board.

Flashing question mark appears on the screen

1. Boot from the system CD that came with the computer and see if the hard drive mounts on the desktop.
2. Launch Drive Setup and update the hard drive driver.
3. If no hard drive is found in Drive Setup, verify the hard drive cable connections.
4. Replace the hard drive cable.
5. Reinstall the software drivers for the hard drive.
6. Reinstall system software. Backup the data first.
7. Reinitiation the hard drive.
8. Replace the hard drive.
9. Replace the logic board.

System hangs during normal startup process

1. Boot from the system CD that came with the computer and see if the hard drive mounts on the desktop.
2. Using Drive Setup, reinstall the system software drivers for the hard drive.
3. Using Drive Setup, reinitiation the hard drive.
4. Check all cable connections to and from the hard drive.
5. Replace the hard drive cable.
6. Replace the hard drive.
7. Replace the logic board.

Optical Drive

Optical drive won't mount to the desktop

1. Try cleaning the disc. If it is dirty or scratched, it may not mount.
2. Try a different disc.
3. Boot from Apple Hardware Test (hold down the "C" key at startup) or boot from the system install CD (use Startup Manager, hold down the Option key at startup).
4. Perform a clean install with the CD that came with the computer.
5. Replace the optical drive cable.
6. Replace the optical drive.
7. Replace the logic board.

Can't boot from the optical drive

1. Try cleaning the disc. If it is dirty or scratched, it may not mount.
2. Try a different disc.
3. Boot from Apple Hardware Test (hold down the "C" key at startup) or boot from the system install CD (use Startup Manager, hold down the Option key at startup).
4. Perform a clean install with the CD that came with the computer.
5. Replace the optical drive cable.
6. Replace the optical drive.
7. Replace the logic board.

Optical disc constantly ejects

1. Disconnect all peripheral devices, especially the mouse in cases where the disc is constantly ejecting.
2. Try cleaning the disc. If it is dirty or scratched, it may not mount.
3. Try a different disc.
4. Boot from Apple Hardware Test (hold down the "C" key at startup) or boot from the system install CD (use Startup Manager, hold down the Option key at startup).
5. Perform a clean install with the CD that came with the computer.
6. Replace the optical drive cable.
7. Replace the optical drive.
8. Replace the logic board.

Sound Out

No sound from either internal or external speakers

1. Verify volume setting is correct in system preferences.
2. Replace the external speakers or headphone in question with a known-good device.
3. Reset parameter RAM. Press Command-Option-P-R during startup before “Welcome to Macintosh” appears.
4. Verify internal speaker cable is connected.
5. Replace the internal speaker.
6. Replace the logic board.

Sound In

No sound is recorded

1. Check setup of the system preferences for the microphone.
2. Check the microphone cable connection.
3. Replace the internal microphone.
4. Replace the neck assembly.

Error Beep(s)

Computer beeps at startup.

1. RAM expansion DIMMs for the iMac must be DDR 333 PC2700 compliant SDRAM devices. If the user installs a DIMM that uses EDO or SGRAM devices, the computer will beep several times when the user attempts to restart the computer.
2. Refer to “Power-On Self Test” mentioned earlier in this chapter.

Modem

No modem dial tone

1. Verify known-good analog (not digital) telephone line.
2. Verify known-good RJ-11 telephone cable.
3. Verify RJ-11 cable is not plugged into Ethernet port.
4. Inspect RJ-11 connector and modem port for pin damage.
5. Verify RJ-11 cable is firmly installed in the modem port.
6. Verify correct modem driver is installed and the correct CCL is selected. If the problem persists, reinstall system software.
7. Open the bottom housing. Verify the internal RJ-11 modem cable is connected to the modem.
8. Replace the RJ-11 board.
9. Replace the modem.
10. Replace the logic board.

I/O Ports

Difficulty Plugging in an Ethernet Cable

Note: The Ethernet port on an iMac (Flat Panel) has a special mechanism to prevent modem cables from accidentally being inserted. In some cases, this mechanism can cause difficulty when attempting to plug in an Ethernet cable.

1. Verify that you are plugging into the Ethernet port. See graphic below.

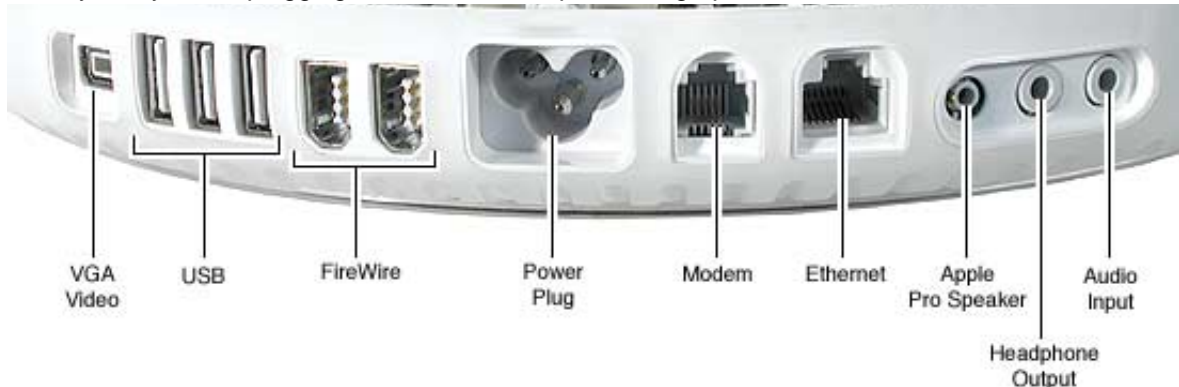

2. Notice that the port has two metal tabs (circled below) which prohibit the use of a modem cable.



3. When inserting the Ethernet cable, try holding the cable at a slight angle and wiggle the connector to get past the metal tabs.
4. Once the connector has passed the metal tabs it should slide in with no further difficulty.



Upgrades
iMac (USB 2.0)



Memory, SO-DIMM

Tools

- #0 Phillips screwdriver.

Part Location



The RAM expansion slot accommodates a standard DDR333 PC2700 compliant SO-DIMM (small outline, dual inline memory) that uses DDR SDRAM devices.

Important: A RAM expansion SO-DIMM for the iMac (USB 2.0) computer must use DDR SDRAM devices. If the user installs an SO-DIMM that uses single data rate (SDR), SGRAM, or non-DDR SDRAM devices, the computer will beep twice when the user attempts to restart the computer.

Note: This procedure describes installing a SO-DIMM memory module in the user-accessible slot. The iMac (USB 2.0) computer can accommodate standard SO-DIMMs with a height of 1.0 or 1.25 inches.

Procedure

Opening the Computer

Warning: The computer must be turned off before RAM modules are removed or inserted. To remind you, a red LED is visible in the access door. If the red LED is on, power is on, and must be turned off before changing RAM modules.

1. Shut down the computer.
2. Unplug all cables from the computer except the power cord.
3. Lay the computer down on a soft cloth.



4. Loosen the four captive screws at the base of the computer and gently remove the access panel.

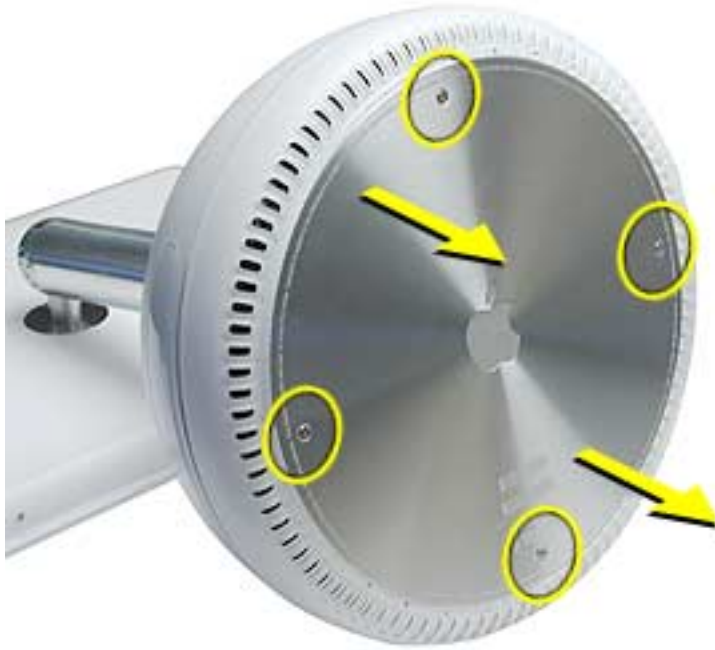

Important: To avoid electrostatic discharge, always ground yourself by touching metal before you touch any parts or install any components inside the computer. To avoid static electricity building back up in your body, do not walk around the room until you have completed the installation and closed the computer.

5. Touch a metal surface inside the computer.



6. Unplug the power cord.

Installing the Memory Module

Note: If you are replacing a defective memory module, rather than adding a module, remove the defective module before proceeding.

1. Line up the notch on the memory module with the notch on the memory slot.
Important: Do not push the slot clips (on each side) when inserting memory. They are used to remove memory from the slot, not to insert memory. These clips are fragile and could break.

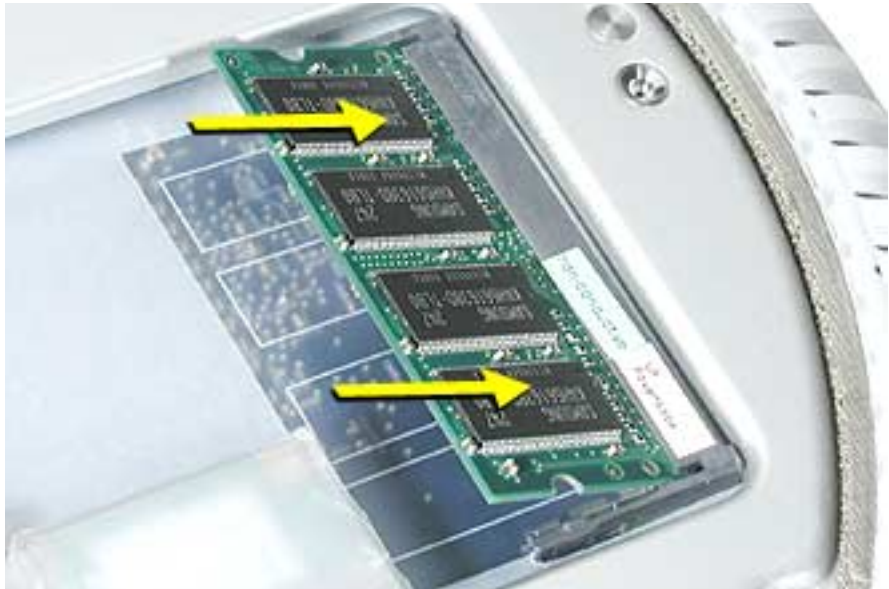

2. Gently insert the memory module into the slot. You will hear a click when the memory is completely inserted into the slot. **Note:** Make certain to push the memory module in the direction of the arrows.



Closing the Computer

1. Replace the access panel and the four screws.

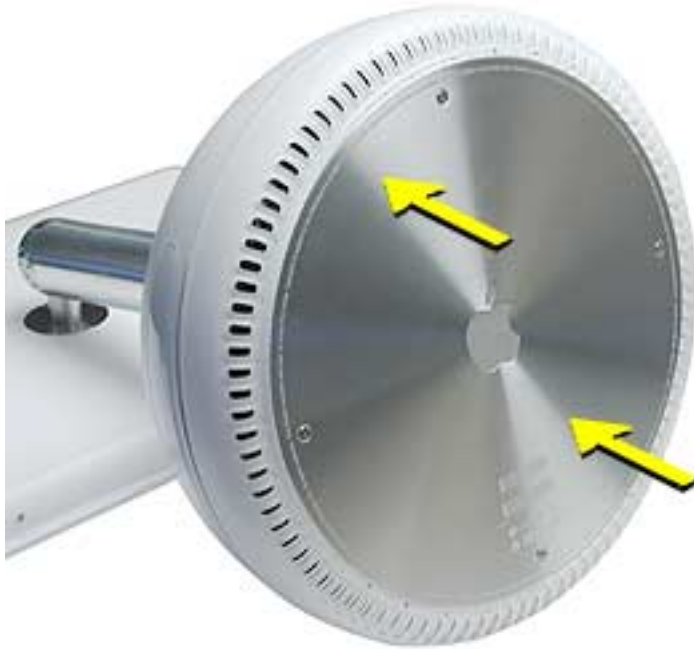

2. Reconnect all cables and restart the computer.

Warning: Never turn on the computer unless all of its internal and external parts are in place and it is closed. Operating the computer when it is open or missing parts can damage your computer or cause injury.



AirPort Extreme Card

Tools

- #0 Phillips screwdriver to remove the user access panel.

Part Location



Opening the Computer

Warning: Always shut down your computer before opening it to avoid damaging its internal components or causing injury. Shut down the computer and wait five minutes before continuing.

1. Unplug all cables from the computer except the power cord.
2. Lay the computer down on a soft cloth.



3. Loosen the four captive screws at the base of the computer and gently remove the access panel.

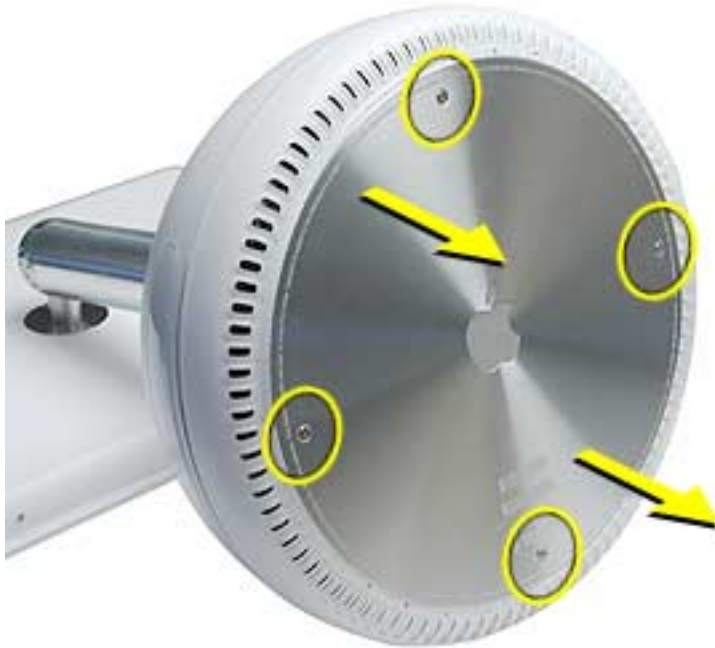

Important: To avoid electrostatic discharge, always ground yourself by touching metal before you touch any parts or install any components inside the computer. To avoid static electricity building back up in your body, do not walk around the room until you have completed the installation and closed the computer.

4. Touch a metal surface inside the computer.



5. Unplug the power cord.

Installing the AirPort Extreme Card

Note: If you are replacing a defective AirPort Extreme Card, rather than adding a card, remove the defective card before proceeding.

1. Connect the AirPort antenna to the AirPort Extreme Card.



2. Insert the card into the AirPort Extreme slot. Push the card until you hear it click into the slot.



Closing the Computer

1. Replace the access panel and tighten the four captive screws.

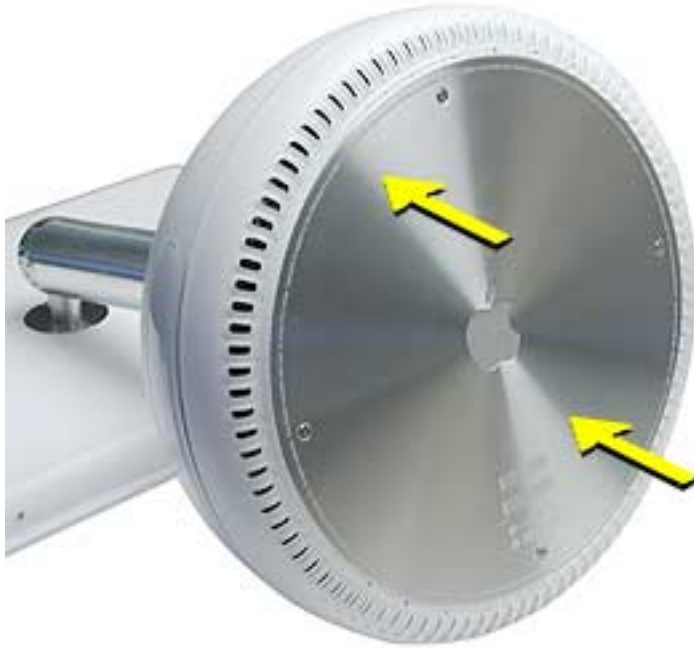

2. Reconnect all cables and restart the computer.

Warning: Never turn on the computer unless all of its internal and external parts are in place and it is closed. Operating the computer when it is open or missing parts can damage your computer or cause injury.



Views

iMac (USB 2.0)

Exploded View, Base Unit, (iMac USB 2.0)

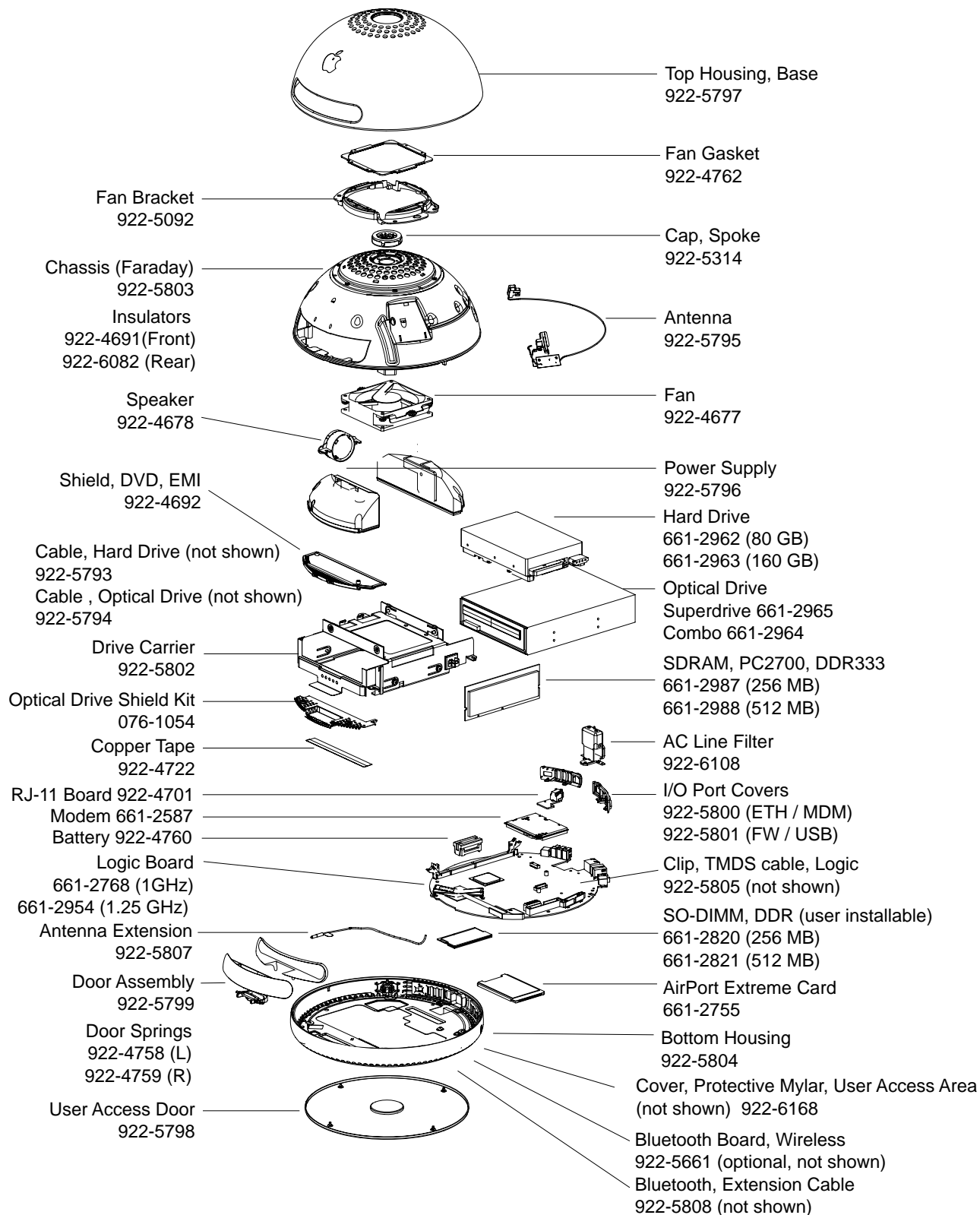

Display Panel, (17", 1.25 GHz, USB 2.0)

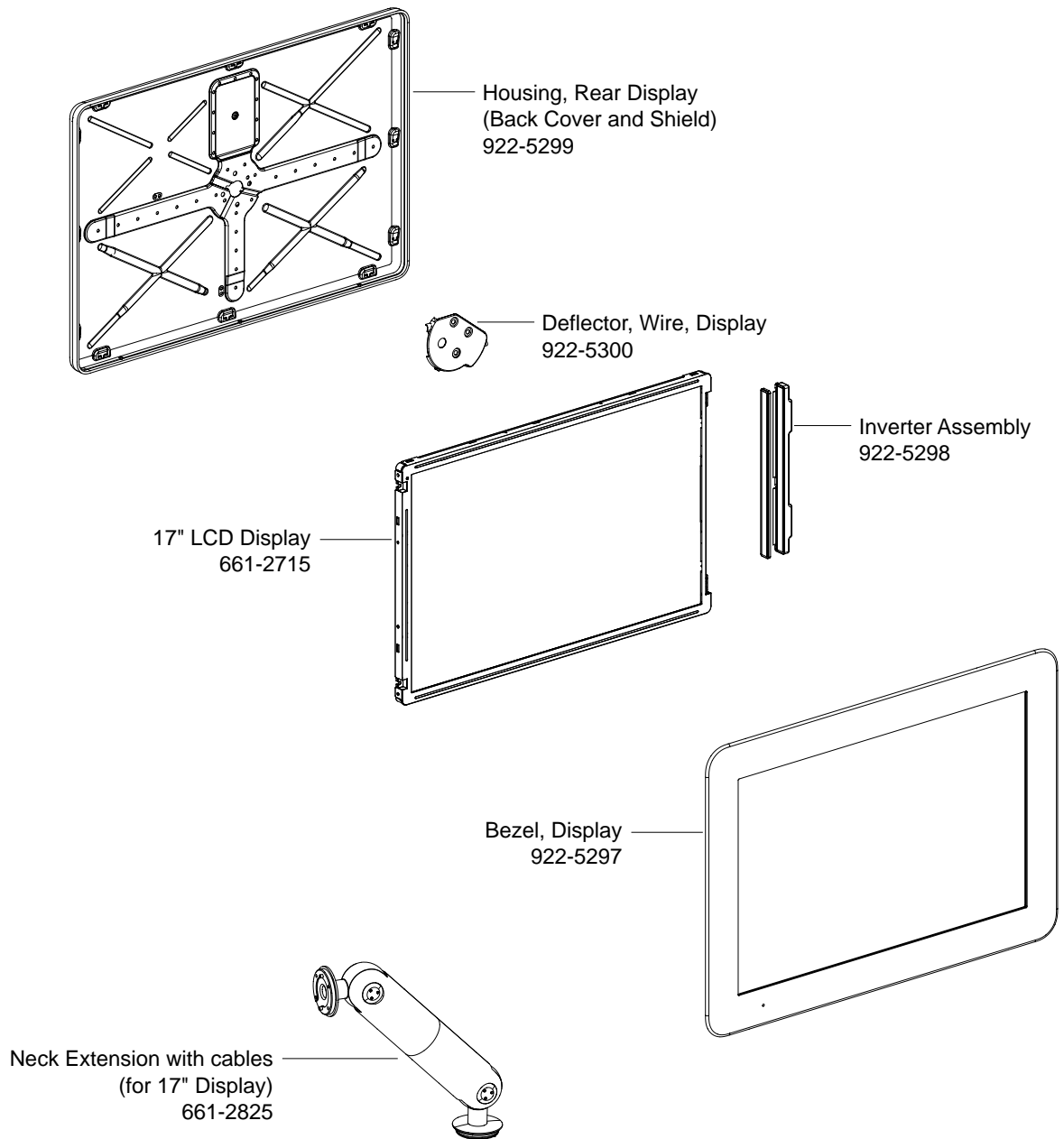

Display Panel, (15", 1 GHz, USB 2.0)

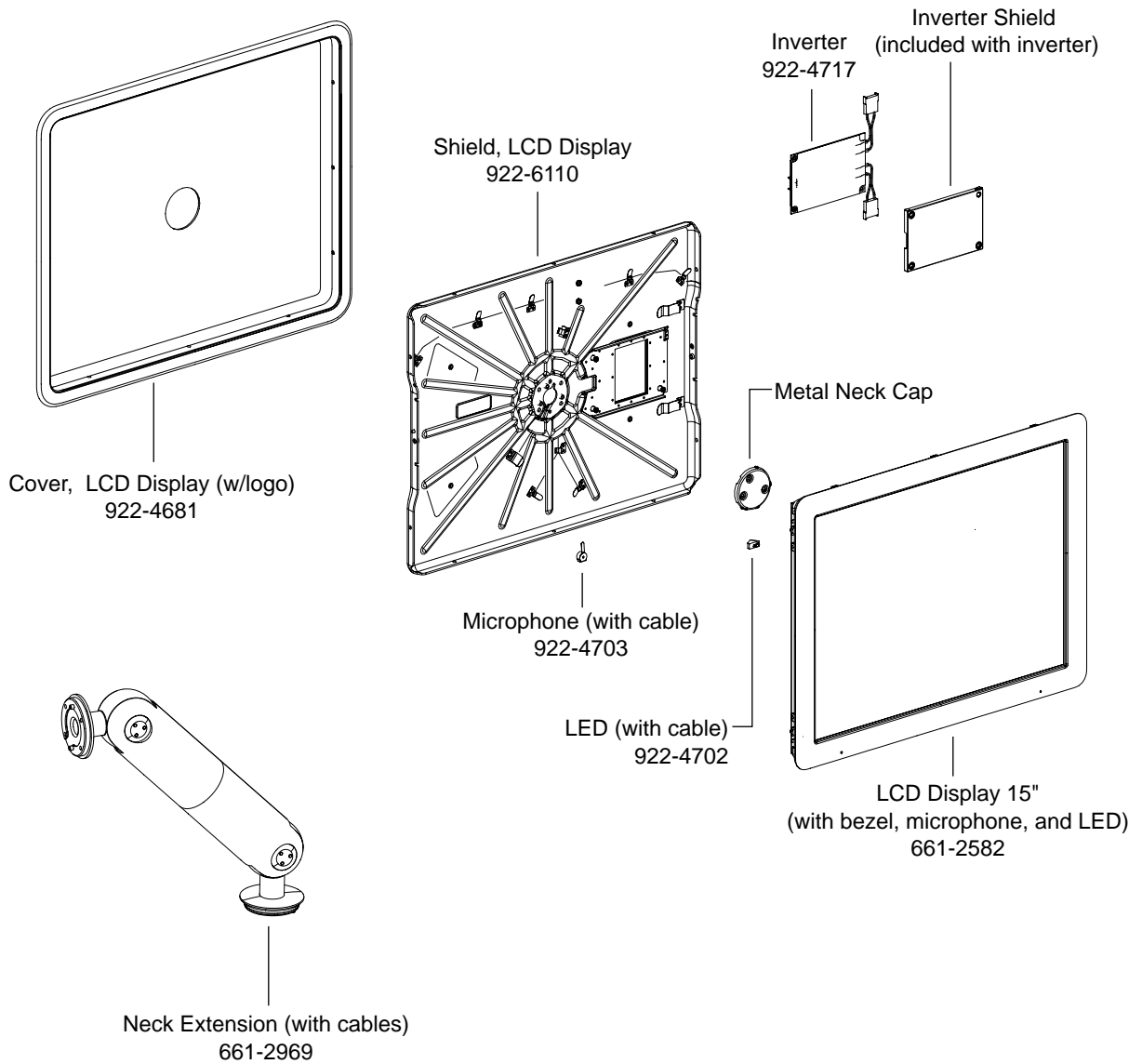

Screw Matrix Locator 1 of 7

Bottom Housing Bolts (4)
T-15, 922-5104

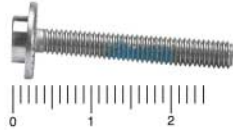

Grounding Screw to Faraday (1)
T-15, 922-4714

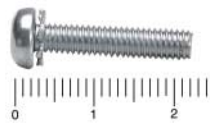

Drive Carrier to Faraday (4)
T-10, 922-4709

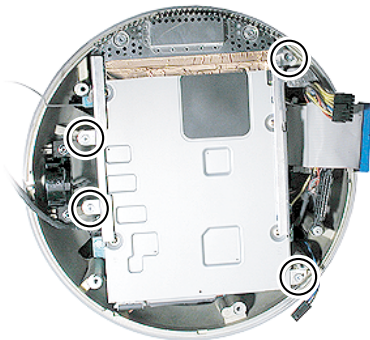

Power Supply (4)
T-10, 922-4709

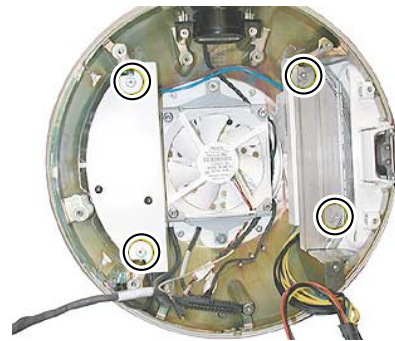

Screw Matrix Locator 2 of 7

Speaker (2)
T-10, 922-4709

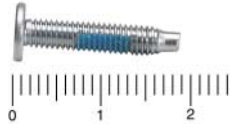

Hard Drive to Carrier to Assy (4)
T-10, 922-5105



Optical Drive to Carrier Assy (4)
T-10, 922-5107



Power Supply Shield (2)
T-10, 922-4707

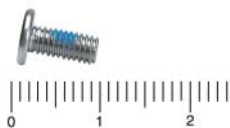

Screw Matrix Locator 3 of 7

Metal DVD Shield (2)
T-10, 922-4707

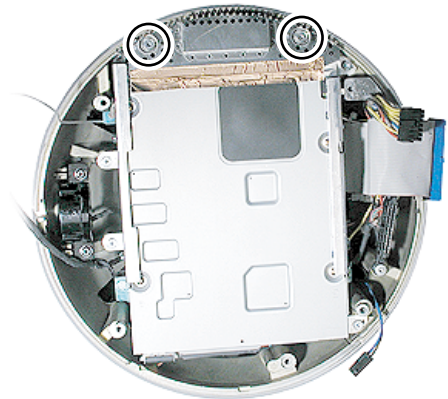
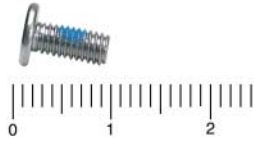

Fan (2)
T-15, 922-4710

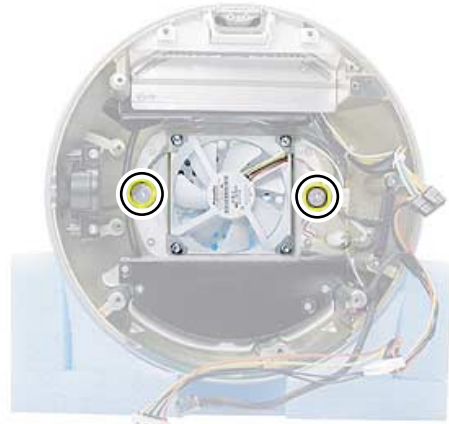

Door Hinge (2)
T-10, 922-5108

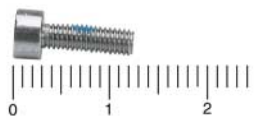

Screw Matrix Locator 4 of 7

Bluetooth Board (2)
Phillips #1, 922-xxxx

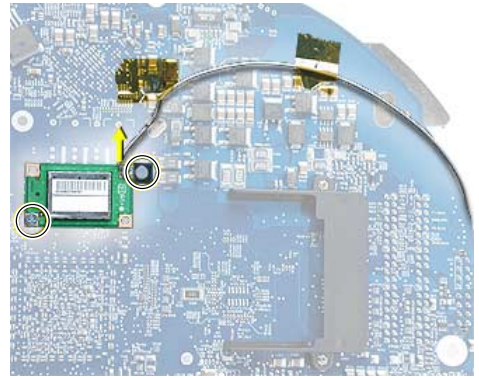

Faraday Under Logo (1)
T-8, 922-4706



White Plastic Cap
2 Black
T-10, 922-5110



White Plastic Cap
3 Silver
T-10, 922-5111

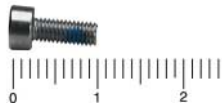

Screw Matrix Locator 5 of 7

White, Plastic Neck
Cable Retainer (4)
T-10, 922-5112

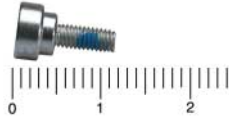

LCD Bezel for 17" (3)
1.5mm 922-5336



LCD Bezel for 15" (10)
(10) for 15"
1.5mm 922-5336



Antenna to Faraday (2)
T-10 922-



Screw Matrix Locator 6 of 7

Deflector, Wire, Display (4)
T-10, 17"
922-4723

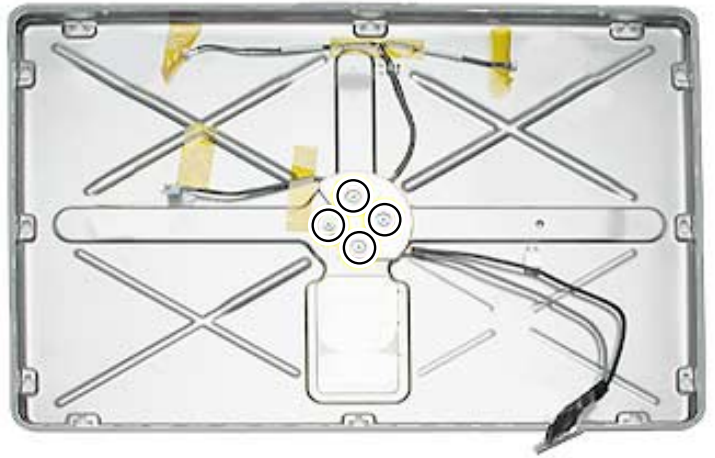

Logic Board,
Metal (3)
Plastic (1)
T-15

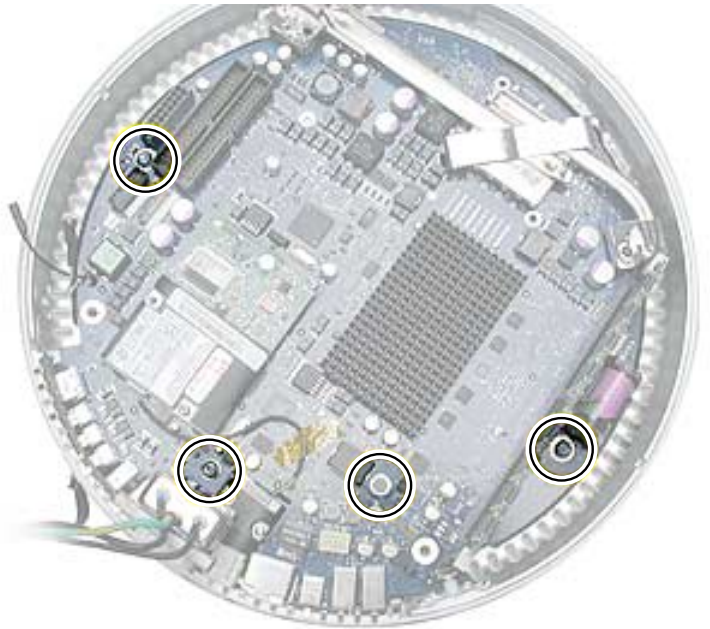
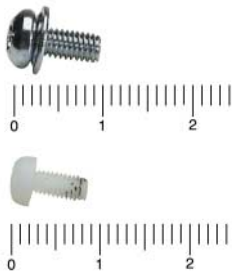

RJ-11 Board (2)
T-6 922-5115

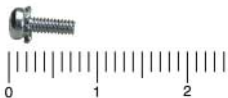

Screw Matrix Locator 7 of 7

Modem (2)
T-8 922-5116





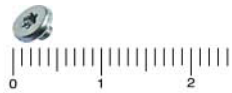



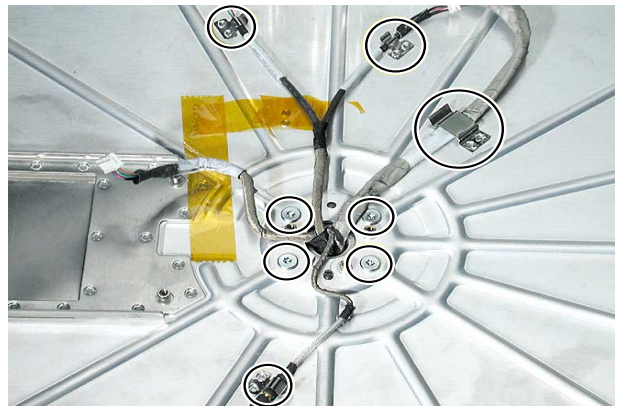











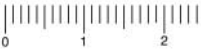









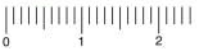















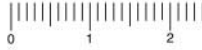

AC Line Filter (2)
T-10 922-5117

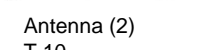

Neck to Back of LCD
Display 15"
T-10 922-5120



Screw Chart

| | | | |
|--|---|---|--|
| <p style="text-align: center;">iMac (Flat Panel,USB 2.0) 17" 1.25 GHz 15" 1 GHz Screw Matrix</p> |   Bottom Housing Bolts (4) T-15 922-5104 |   Grounding Screw to Faraday (1) T-15 922-4714 |   Speaker (2) Power Supply (4) Drive Carrier to Faraday (4) T-10 922-4709 |
|   Hard Drive to Carrier to Assy (4) T-10 922-5105 |   Optical Drive to Carrier Assy (4) T-10 922-5107 |   Power Supply Shield (2) Metal DVD Shield (2) T-10 922-4707 |   Fan (2) T-15 922-4710 |
|   Door Hinge (2) T-10 922-5108 |   Fan Bracket to Fan (2) T-25 922-4708 |   Faraday to Outer Shell (1) T-10 922-5106 |   Faraday Under Logo (1) T-8 922-4706 |
|   Cap, Spoke Cap 2 Black T-10 922-5110 |   Cap Spoke Cap 2 Silver T-10 922-5111 |   White, Plastic Neck Cable Retainer (4) T-10 922-5112 |   Neck to back of LCD display (4), under metal biscuit T-10 922-5120 |
|   Logic Board, Metal (3) T-15 922-4715 |   Logic Board, Plastic (1) Phillips 0 922-5113 |   RJ-11 Board (2) T-6 922-5115 |   Modem (2) T-8 922-5116 |
|   AC Line Filter (2) T-10 922-5117 |   Antenna (2) T-10 |   Panel to Frame (4)-17" only T-10 922-5331 |   Display to Rear Housing 1.5 mm hex 922-5336 |
|   Bluetooth Board (2) 076-1067 kit Phillips #1 | <p style="text-align: center;">Support to Extension 922-5332</p> | | |