

## iMac (17-inch Flat Panel)

Updated August 23, 2002







Take Apart  
iMac (17-inch Flat Panel)



# Tools

The following tools are recommended for the take apart procedures.

- service repair kit (076-0900) includes:
  - the service stand (076-0898)
  - diagnostic cables (076-0897)
- thermal paste (922-4757)
- torque driver (076-0899)
- 1.5 mm hex driver (for LCD bezel screws)
- phillips #0 screwdriver)
- torx screwdriver set (6, 8, 10, 15, 25)
- plastic flatblade screwdriver or stylus
- needlenose pliers
- ESD wriststrap and mat

## Service Stand



1. Support the computer by neck and the base (A). Gently position the computer in the service stand with the flat panel facing up (B).

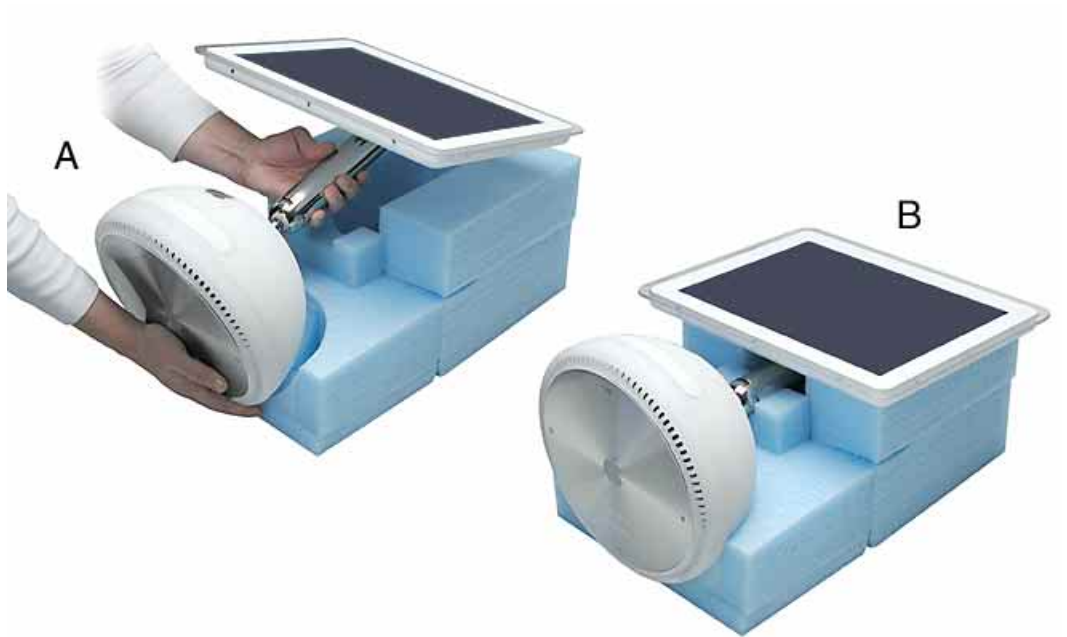

2. **Note:** The base of the computer can be rotated when servicing internal parts.





# User Access Plate

## Tools

This procedure requires the following tools:

- Phillips #0 screwdriver

## Part Location



## Preliminary Steps

Before you begin, do the following:

- Position the computer in the service stand.

---

## Procedure

1. Loosen the four captive screws on the access panel.
2. Remove the panel by grabbing onto two captive screws and lift the panel off the base.





# AirPort Card

## Tools

This procedure requires no tools.

## Part Location



## Preliminary Steps

Before you begin, do the following:

- Position the computer in the service stand.
- Remove the user access plate.



## Procedure

1. Unplug all cables from the computer except the power cord.
2. **Important:** To avoid electrostatic discharge, always ground yourself by touching metal before you touch any parts or install any components inside the computer. To avoid static electricity building back up in your body, do not walk around the room until you have completed the installation and closed the computer.
3. Touch a metal surface inside the computer to ground yourself.



4. Unplug the power cord.
5. Disconnect the AirPort antenna and pull the plastic tab to remove the card from the slot.





# Memory, SO-DIMM (user-installable)

## Tools

No tools are required for this procedure.

## Part Location



**Note:** The user-installable memory slot is identified as Slot J12 by Apple Hardware Test and Apple System Profiler.

## Preliminary Steps

Before you begin, do the following:

- Position the computer in the service stand.
- Remove the user access plate.

**Note:** There are two RAM expansion slots on the computer. One slot (top of the logic board) accepts the factory-installed standard PC-133 168-pin DIMM. The other slot (bottom of logic board) accepts a standard PC-133 144-pin SO-DIMM and is accessible on the bottom of the computer. Only the SO-DIMM slot is accessible by the user.

## Procedure

1. Unplug all cables from the computer except the power cord.
2. **Important:** To avoid electrostatic discharge, always ground yourself by touching metal before you touch any parts or install any components inside the computer. To avoid static electricity building back up in your body, do not walk around the room until you have completed the installation and closed the computer.
3. Touch a metal surface inside the computer to ground yourself.



4. Unplug the power cord.
5. Push the tabs outward to release the memory.



6. Remove the memory from the slot.

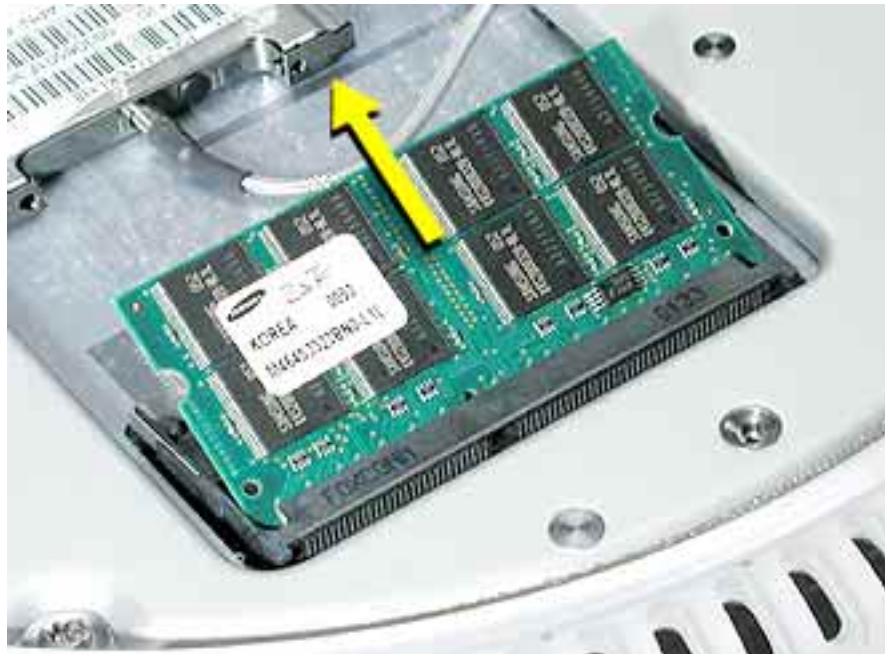



# Bottom Housing

## Tools

This procedure requires the following tools:

- Torx-15 screwdriver

## Part Location



## Preliminary Steps

Before you begin, do the following:

- Position the computer in the service stand.
- Remove the user access plate.

## Procedure

1. Rotate the base so the optical drive door is on the right. Remove the four torx screws.



**Replacement Note:** These torx screws must be tightened to at least 17 in.-lbs. If you do not have a torque driver, you will have to make sure these screws are tightened by hand **FIRMLY, BUT NOT FORCIBLY**. Or, purchase the service tool (076-0899) in order to ensure the thermal pipe is firmly mated with the top base. If the bottom housing is not securely attached to the base in this fashion, the CPU may overheat and become damaged. For more information, refer to “Thermal Paste Application” in this chapter. Rotate the base so that the optical drive door is on the right.

- 
2. Gently open the bottom housing in the direction of the arrow. **Note:** Cables are still attached to the logic board.



3. Disconnect the following:
  - A Power supply connector
  - B Hard drive/optical drive data cable
  - C AC line filter connector
  - D AirPort antenna connector
  - E Plastic cable retainer and video cable
  - F Grounding screw

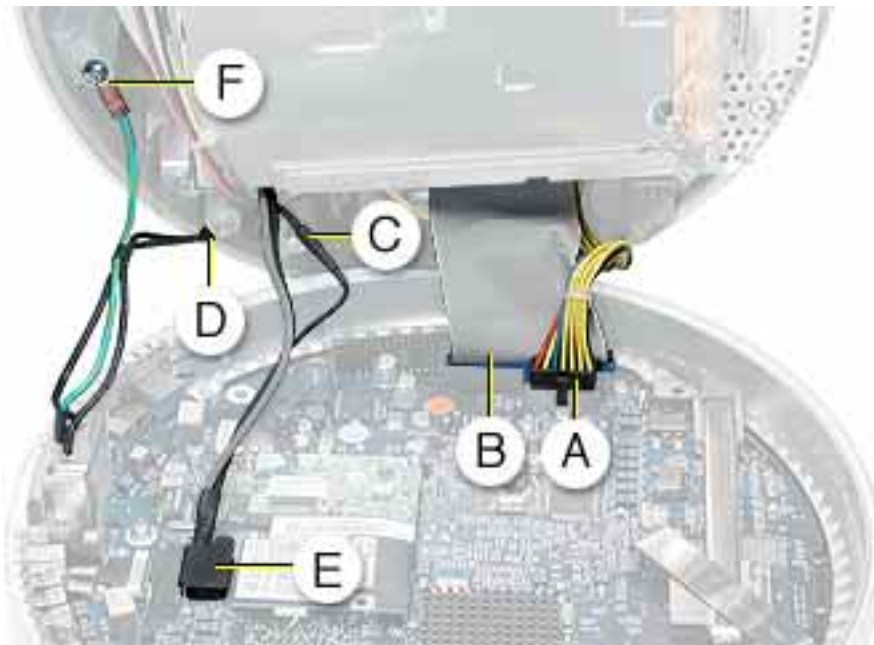

4. Set the bottom housing aside.

**Warning:** Whenever the bottom housing is opened for service, you must do two things:

1. You must clean the original thermal film from all thermal interface mating surfaces, and reapply thermal paste to the mating surfaces on the thermal pipe.
2. You must tighten the four torx screws on the bottom housing to a minimum of 17 in.-lbs. Use a torque driver (service tool 076-0899) to ensure that the thermal pipe is firmly mated with the top base. If you do not have a torque driver, you must make sure the screws are tightened by hand **FIRMLY, BUT NOT FORCIBLY**.

**Warning: Failure to follow these steps could cause the computer to overheat and damage internal components.**

Refer to the topic “Thermal Paste Application” for detailed information.





# Thermal Paste Application

## Tools

This procedure requires the following tools:

- Plastic stylus or plastic spatula to remove the old thermal paste
- Plastic stylus or plastic spatula to spread the thermal paste
- Thermal paste (922-4757)

## Part Location



## Procedure

1. Thoroughly clean the original thermal film from the mating surfaces (circled below) of the bottom housing and thermal pipe. Use a plastic stylus to scrape the surfaces clean. **Note:** Do not use an abrasive material or liquid cleaner.



2. Squeeze a thin film of thermal paste onto the mating surfaces of the thermal pipe.

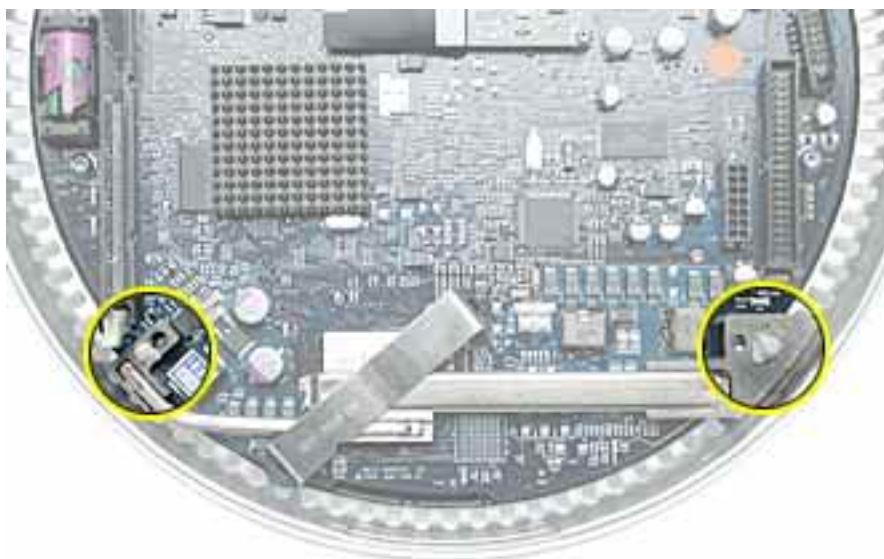

- 
3. Replace the bottom housing.

**Warning:** The bottom housing has four torx screws that must be tightened to at least 17 in.-lbs. Use a torque driver (service tool 076-0899) to ensure that the thermal pipe is firmly mated with the top base. If you do not have a torque driver, you must make sure the screws are tightened by hand **FIRMLY, BUT NOT FORCIBLY**.

**Warning: Failure to apply the thermal paste as described in this procedure, and failure to tighten the torx screws as directed, could cause the computer to overheat and damage internal components.**

Refer to the topic “Thermal Paste Application” for detailed information.



# RJ-11 Modem Filter Board

## Tools

This procedure requires the following tools:

- Torx-6 screwdriver

## Part Location

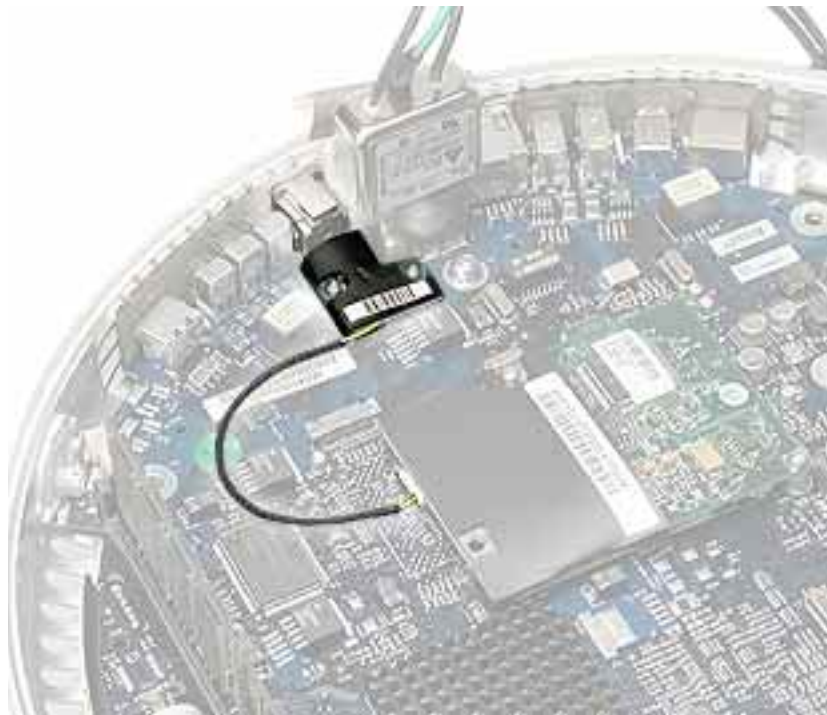

## Preliminary Steps

Before you begin, do the following:

- Position the computer in the service stand.
- Remove the user access plate.
- Remove the bottom housing.

## Procedure

1. Remove two screws and disconnect the cable from the modem.

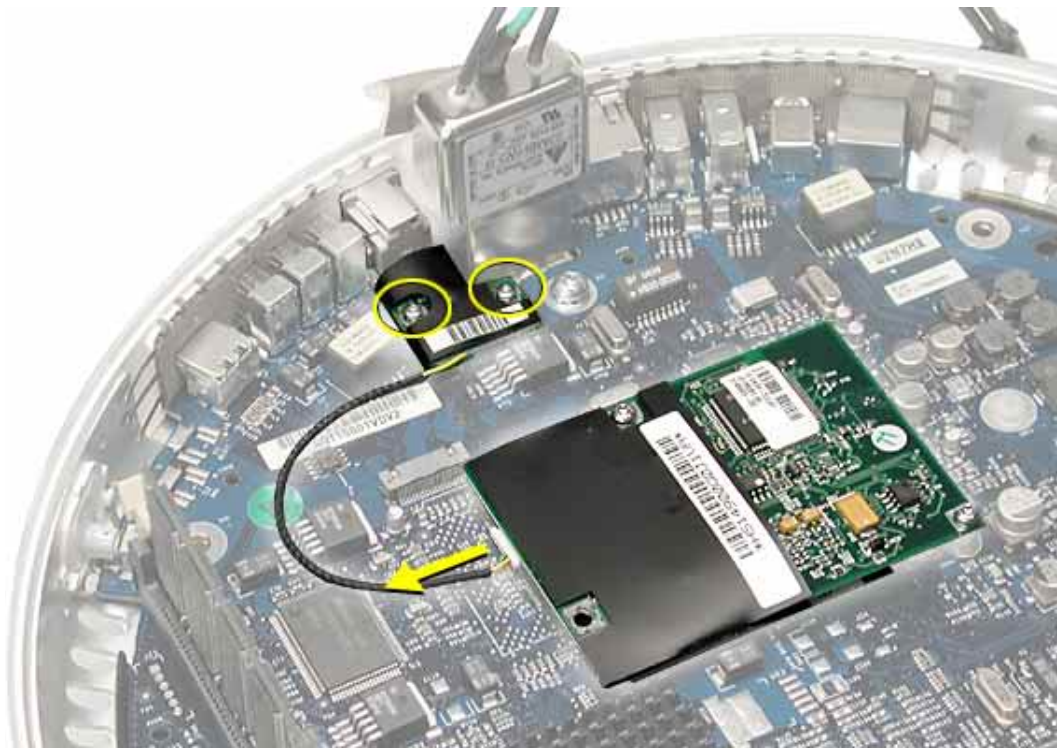

2. Remove the RJ-11 board from the I/O port.

**Warning:** Whenever the bottom housing is opened for service, you must do two things:

1. You must clean the original thermal film from all thermal interface mating surfaces, and reapply thermal paste to the mating surfaces on the thermal pipe.
2. You must tighten the four torx screws on the bottom housing to a minimum of 17 in.-lbs. Use a torque driver (service tool 076-0899) to ensure that the thermal pipe is firmly mated with the top base. If you do not have a torque driver, you must make sure the screws are tightened by hand **FIRMLY, BUT NOT FORCIBLY**.

**Warning: Failure to follow these steps could cause the computer to overheat and damage internal components.**

Refer to the topic "Thermal Paste Application" for detailed information.



# Modem

## Tools

This procedure requires the following tools:

- Torx-8 screwdriver

## Part Location



## Preliminary Steps

Before you begin, do the following:

- Position the computer in the service stand.
- Remove the user access plate.
- Remove the bottom housing.

## Procedure

1. Remove two screws and disconnect the cable.



2. Lift the modem from the connector on the logic board.

**Warning:** Whenever the bottom housing is opened for service, you must do two things:

1. You must clean the original thermal film from all thermal interface mating surfaces, and reapply thermal paste to the mating surfaces on the thermal pipe.
2. You must tighten the four torx screws on the bottom housing to a minimum of 17 in.-lbs. Use a torque driver (service tool 076-0899) to ensure that the thermal pipe is firmly mated with the top base. If you do not have a torque driver, you must make sure the screws are tightened by hand **FIRMLY, BUT NOT FORCIBLY.**

**Warning: Failure to follow these steps could cause the computer to overheat and damage internal components.**

Refer to the topic “Thermal Paste Application” for detailed information.



# Memory (factory-installed)

## Tools

This procedure requires the following tools:

- No tools are required

## Part Location



**Note:** The factory-installed memory slot is identified as Slot J13 by Apple Hardware Test and Apple System Profiler.

## Preliminary Steps

Before you begin, do the following:

- Position the computer in the service stand.
- Remove the user access plate.
- Remove the bottom housing.



## Procedure

1. Push down on the ejector tabs to release the memory module.
2. Pull the memory up and out of the slot.

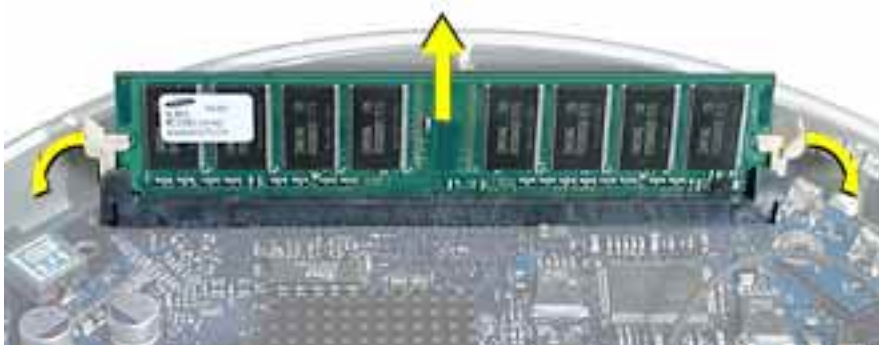

**Warning:** Whenever the bottom housing is opened for service, you must do two things:

1. You must clean the original thermal film from all thermal interface mating surfaces, and reapply thermal paste to the mating surfaces on the thermal pipe.
2. You must tighten the four torx screws on the bottom housing to a minimum of 17 in.-lbs. Use a torque driver (service tool 076-0899) to ensure that the thermal pipe is firmly mated with the top base. If you do not have a torque driver, you must make sure the screws are tightened by hand **FIRMLY, BUT NOT FORCIBLY**.

**Warning: Failure to follow these steps could cause the computer to overheat and damage internal components.**

Refer to the topic “Thermal Paste Application” for detailed information.



# Battery

## Tools

This procedure requires the following tools:

- No tools are required

## Part Location



## Preliminary Steps

Before you begin, do the following:

- Position the computer in the service stand.
- Remove the user access plate.
- Remove the bottom housing.

## Procedure

1. Using a flatblade screwdriver, gently pry the battery from the battery holder.

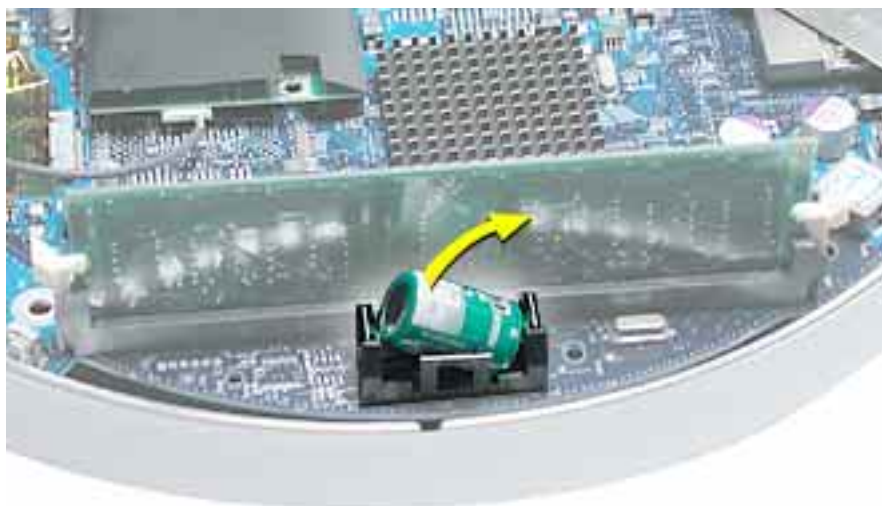

**Warning:** Whenever the bottom housing is opened for service, you must do two things:

1. You must clean the original thermal film from all thermal interface mating surfaces, and reapply thermal paste to the mating surfaces on the thermal pipe.
2. You must tighten the four torx screws on the bottom housing to a minimum of 17 in.-lbs. Use a torque driver (service tool 076-0899) to ensure that the thermal pipe is firmly mated with the top base. If you do not have a torque driver, you must make sure the screws are tightened by hand **FIRMLY, BUT NOT FORCIBLY**.

**Warning: Failure to follow these steps could cause the computer to overheat and damage internal components.**

Refer to the topic “Thermal Paste Application” for detailed information.



# Logic Board

## Tools

This procedure requires the following tools:

- Phillips #2 screwdriver (for the plastic screw)
- Torx-15 screwdriver

## Part Location

**Note:** The battery, RJ-11 board, AirPort card, modem, I/O port covers, and memory (on the top and the bottom of the logic board) need to be removed from the logic board before returning the board to Apple for service.



## Preliminary Steps

Before you begin, do the following:

- Position the computer in the service stand.
- Remove the user access plate.
- Remove the bottom housing.
- Remove the RJ-11 board.

---

## Procedure

1. Remove the three metal torx screws and the one plastic screw.

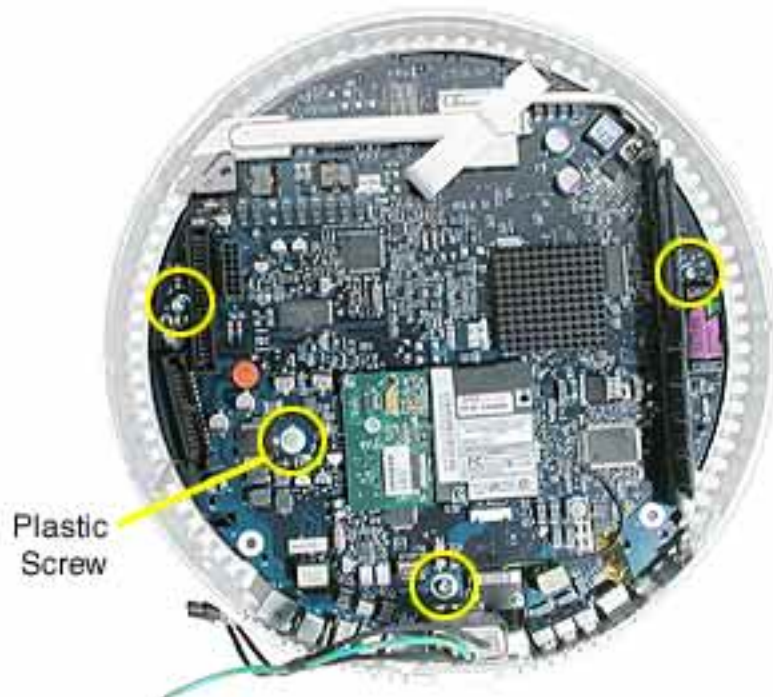

2. Grab the logic board by the battery retainer and the hard drive connector. Lift the board and pull back to release the board from the bottom housing and I/O ports. **Note:** The I/O port covers may come out with the logic board when it's removed.

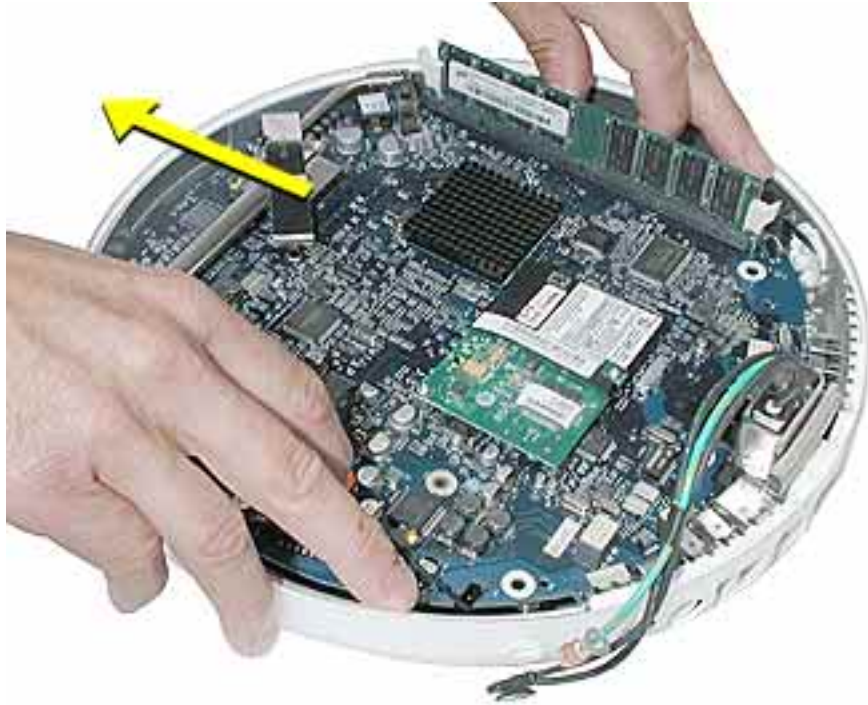

3. Remove the I/O port covers from the logic board.

**Warning:** Whenever the logic board is separated from the bottom housing, you must install new thermal pads to three surfaces on the bottom housing. Failure to apply these pads whenever the logic board is separated from the bottom housing could cause these parts to overheat and could damage internal components.

**Note:** AFTER installing new thermal pads, if you must briefly re-separate the logic board from the housing, it is OK to retain the same, new pads as long as they are not handled excessively. Refer to “Thermal Pad Installation” in this chapter for detailed information.

**Warning:** Whenever the bottom housing is opened for service, you must do two things:

1. You must clean the original thermal film from all thermal interface mating surfaces, and reapply thermal paste to the mating surfaces on the thermal pipe.
2. You must tighten the four torx screws on the bottom housing to a minimum of 17 in.-lbs. Use a torque driver (service tool 076-0899) to ensure that the thermal pipe is firmly mated with the top base. If you do not have a torque driver, you must make sure the screws are tightened by hand **FIRMLY, BUT NOT FORCIBLY**.

**Warning: Failure to follow these steps could cause the computer to overheat and damage internal components.**

Refer to the topic “Thermal Paste Application” for detailed information.



# I/O Port Covers

## Tools

This procedure requires the following tools:

- No tools are required

## Part Location



## Preliminary Steps

Before you begin, do the following:

- Position the computer in the service stand.
- Remove the user access plate.
- Remove the bottom housing.
- Remove the RJ-11 board
- Remove the logic board.

## Procedure

1. Gently remove the I/O port covers from the logic board.

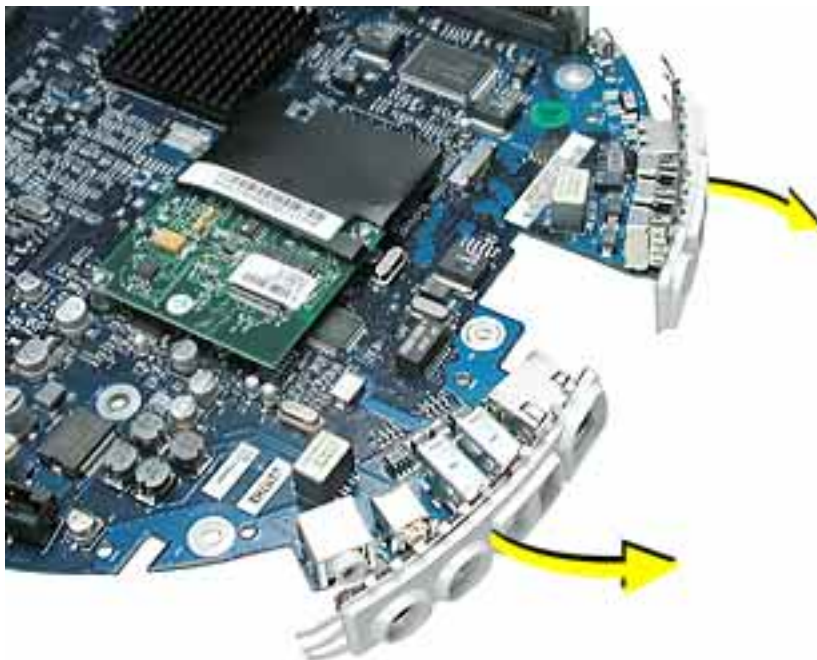

**Warning:** Whenever the bottom housing is opened for service, you must do two things:

1. You must clean the original thermal film from all thermal interface mating surfaces, and reapply thermal paste to the mating surfaces on the thermal pipe.
2. You must tighten the four torx screws on the bottom housing to a minimum of 17 in.-lbs. Use a torque driver (service tool 076-0899) to ensure that the thermal pipe is firmly mated with the top base. If you do not have a torque driver, you must make sure the screws are tightened by hand **FIRMLY, BUT NOT FORCIBLY**.

**Warning: Failure to follow these steps could cause the computer to overheat and damage internal components.**

Refer to the topic “Thermal Paste Application” for detailed information.

**Warning:** Whenever the logic board is separated from the bottom housing, you must install new thermal pads to three surfaces on the bottom housing. Failure to apply these pads whenever the logic board is separated from the bottom housing could cause these parts to overheat and could damage internal components.

**Note:** AFTER installing new thermal pads, if you must briefly re-separate the logic board from the housing, it is OK to retain the same, new pads as long as they are not handled excessively. Refer to “Thermal Pad Installation” in this chapter for detailed information.





# Antenna Extension Cable

## Tools

This procedure requires the following tools:

- Torx-10 screwdriver

## Part Location



## Preliminary Steps

Before you begin, do the following:

- Position the computer in the service stand.
- Remove the user access plate.
- Remove the bottom housing.
- Remove the RJ-11 board
- Remove the logic board.

## Procedure

1. Remove two screws (1 below) from the thermal interface layer of the bottom housing.
2. Pry up the thermal interface layer to separate it from the bottom housing. Remove the cable from two plastic cable clips (2 below).

**Replacement Note:** Be careful not to pinch the antenna extension cable when replacing it beneath the thermal interface layer; position the cable in the channel cut into the bottom of the thermal extension layer.

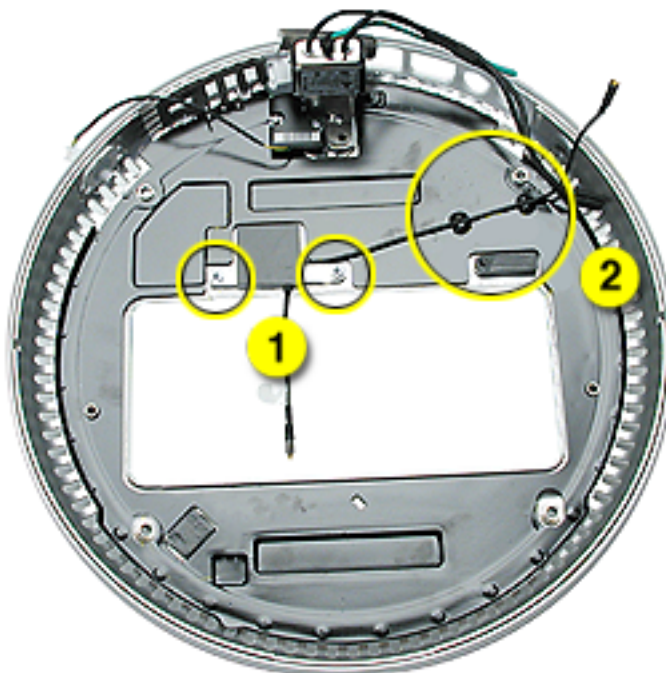

**Warning:** Whenever the bottom housing is opened for service, you must do two things:

1. You must clean the original thermal film from all thermal interface mating surfaces, and reapply thermal paste to the mating surfaces on the thermal pipe.
2. You must tighten the four torx screws on the bottom housing to a minimum of 17 in.-lbs. Use a torque driver (service tool 076-0899) to ensure that the thermal pipe is firmly mated with the top base. If you do not have a torque driver, you must make sure the screws are tightened by hand **FIRMLY, BUT NOT FORCIBLY**.

**Warning: Failure to follow these steps could cause the computer to overheat and damage internal components.**

Refer to the topic “Thermal Paste Application” for detailed information.

**Warning:** Whenever the logic board is separated from the bottom housing, you must install new thermal pads to three surfaces on the bottom housing. Failure to apply these pads whenever the logic board is separated from the bottom housing could cause these

---

parts to overheat and could damage internal components.

**Note:** AFTER installing new thermal pads, if you must briefly re-separate the logic board from the housing, it is OK to retain the same, new pads as long as they are not handled excessively. Refer to “Thermal Pad Installation” in this chapter for detailed information.



# Thermal Pad Installation

## Tools

- No tools are required.
- Thermal pad kit

## Part Location

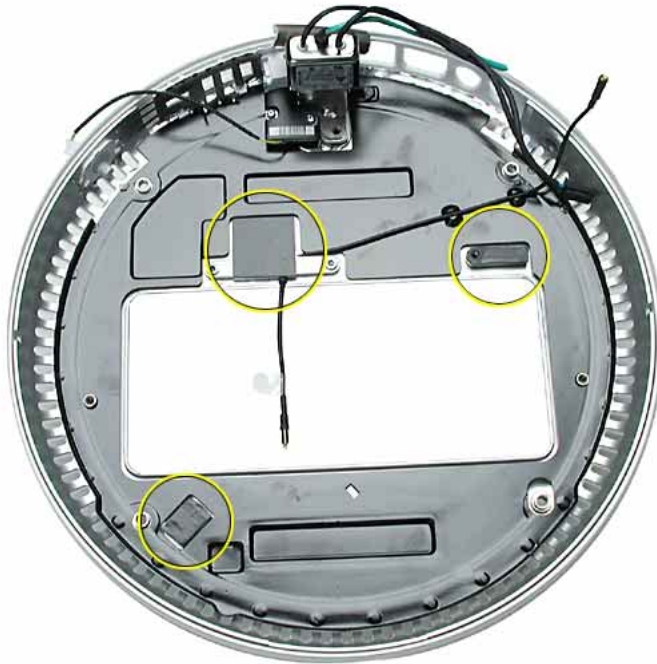

**Warning:** Whenever the logic board is separated from the bottom housing, you must install new thermal pads to three surfaces on the bottom housing. Failure to apply these pads whenever the logic board is separated from the bottom housing could cause these parts to overheat and could damage internal components.

**Note:** AFTER installing new thermal pads, if you must briefly re-separate the logic board from the housing, it is OK to retain the same, new pads as long as they are not handled excessively. Refer to “Thermal Pad Installation” in this chapter for detailed information.

---

## Procedure

1. Remove the old thermal pads (shown below) from the bottom housing. **Note:** If you don't see all three thermal pads on the bottom housing, check the bottom side of the logic board. The thermal pads may stick to the logic board. Either way, remove the old thermal pads.

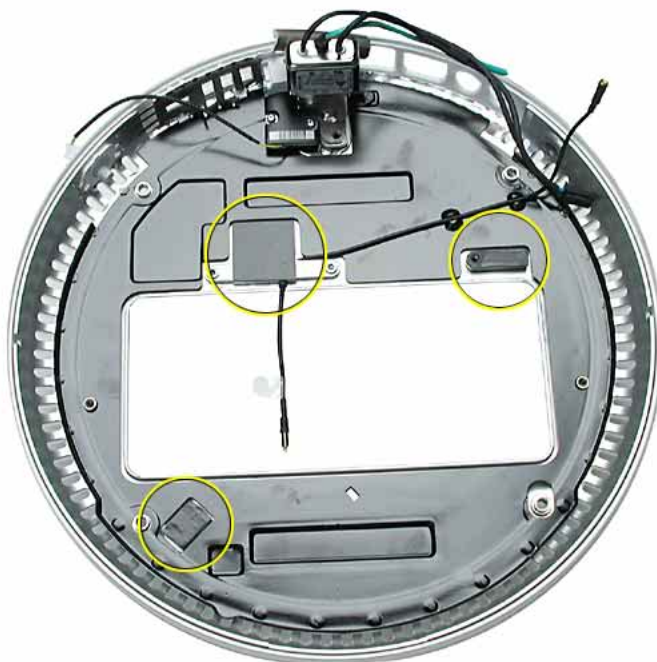

2. Using the thermal pad kit, remove the clear protective backing from the new thermal pads.
3. Place the new thermal pads on the bottom housing. Press down on the blue protective backing to make sure the thermal pad has even contact with the bottom housing. There should be no air pockets.
4. Remove the blue protective backing from the new thermal pad. **Note:** Avoid unnecessary contact with either side of the thermal pad as dirt and body oils reduce the thermal pad's conductivity.
5. Holding the logic board by the battery retainer and the internal drive cable connector, slide the logic board back into the bottom housing (make sure the I/O port covers are on the logic board). **Important:** Do not push on the heatsink for leverage, as you could knock it off the chip.



# AC Line Filter

## Tools

This procedure requires the following tools:

- Torx-10 screwdriver

## Part Location



## Preliminary Steps

Before you begin, do the following:

- Position the computer in the service stand.
- Remove the user access plate.
- Remove the bottom housing.
- Remove the RJ-11 board.
- Remove the logic board.

## Procedure

1. Peel back the black insulator on the bottom housing to access the AC line filter screws.



2. Remove two screws and lift the AC line filter from the bottom housing. **Note:** The AC line port cover plug may fall out of the bottom housing when you remove the AC line filter. Place the plug back into the bottom housing before reinstalling the AC line filter.



---

**Warning:** Whenever the bottom housing is opened for service, you must do two things:

1. You must clean the original thermal film from all thermal interface mating surfaces, and reapply thermal paste to the mating surfaces on the thermal pipe.
2. You must tighten the four torx screws on the bottom housing to a minimum of 17 in.-lbs. Use a torque driver (service tool 076-0899) to ensure that the thermal pipe is firmly mated with the top base. If you do not have a torque driver, you must make sure the screws are tightened by hand **FIRMLY, BUT NOT FORCIBLY**.

**Warning: Failure to follow these steps could cause the computer to overheat and damage internal components.**

Refer to the topic “Thermal Paste Application” for detailed information.

**Warning:** Whenever the logic board is separated from the bottom housing, you must install new thermal pads to three surfaces on the bottom housing. Failure to apply these pads whenever the logic board is separated from the bottom housing could cause these parts to overheat and could damage internal components.

**Note:** AFTER installing new thermal pads, if you must briefly re-separate the logic board from the housing, it is OK to retain the same, new pads as long as they are not handled excessively. Refer to “Thermal Pad Installation” in this chapter for detailed information.





# Drive Carrier Assembly (Optical and Hard Drive)

## Tools

This procedure requires the following tools:

- Torx-10 screwdriver

## Part Location



## Preliminary Steps

Before you begin, do the following:

- Position the computer in the service stand with the door facing up.
- Remove the user access plate.
- Remove the bottom housing.

## Procedure

1. Rotate the base unit so the optical drive door is facing up (as shown below).
2. Remove two screws on the EMI shield. Carefully lift the shield and peel the copper tape off the drive. **Replacement Note:** When replacing the EMI shield, be sure to use the two shorter screws. The longer screws will scratch the top housing.



3. Remove four screws attaching the drive carrier to the metal chassis (also known as the Faraday cage).



4. Remove the Airport antenna and the video cable from the plastic clip on the side of the hard drive.



5. Grasp the carrier on both sides. Lift and pull the carrier in the direction of the arrow. Once the carrier is out, flip the carrier to the right to disconnect the power cables.

**Note:** The carrier fits snugly into the chassis.



6. Peel the white wrapper up to access the screws connecting the hard drive to the carrier. Remove four screws and the hard drive.



---

7. Disconnect the data cables.

8. Remove four screws (shown by circles) to remove the optical drive from the carrier.



9. Slide the optical drive out of the carrier. Be careful of the black plastic dust filter on the carrier. It is very fragile and can rip easily if not handled properly. **Note:** The silver insulator is part of the carrier assembly.



---

**Warning:** Whenever the bottom housing is opened for service, you must do two things:

1. You must clean the original thermal film from all thermal interface mating surfaces, and reapply thermal paste to the mating surfaces on the thermal pipe.
2. You must tighten the four torx screws on the bottom housing to a minimum of 17 in.-lbs. Use a torque driver (service tool 076-0899) to ensure that the thermal pipe is firmly mated with the top base. If you do not have a torque driver, you must make sure the screws are tightened by hand **FIRMLY, BUT NOT FORCIBLY**.

**Warning: Failure to follow these steps could cause the computer to overheat and damage internal components.**

Refer to the topic “Thermal Paste Application” for detailed information.



# Power Supply

## Tools

This procedure requires the following tools:

- Torx-10 screwdriver

## Part Location

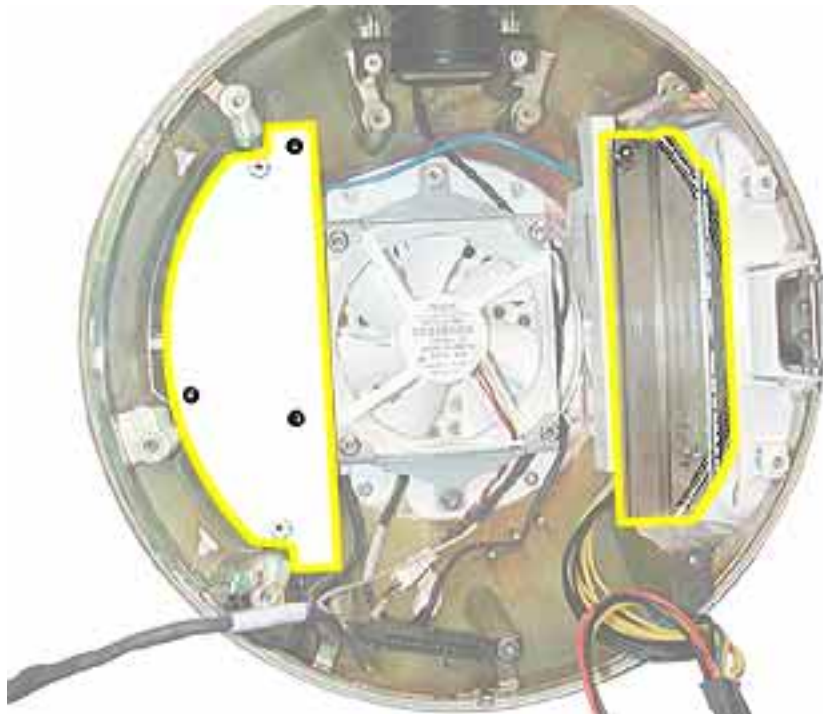

## Preliminary Steps

Before you begin, do the following:

- Position the computer in the service stand and rotate the door to the right.
- Remove the user access plate.
- Remove the bottom housing.
- Remove the drive carrier assembly.



---

## Procedure

1. Remove the two power supply screws circled below.



2. Open the optical drive door as shown. Support the metal plate and power supply as you remove the four screws.

**Important:** The two screws near the door hinge are shorter than the other power supply screws. Failure to replace the shorter screws into their correct location will scratch the top housing. See step 4, Replacement Note.



3. Remove the power supply and metal shield from the chassis (Faraday cage).

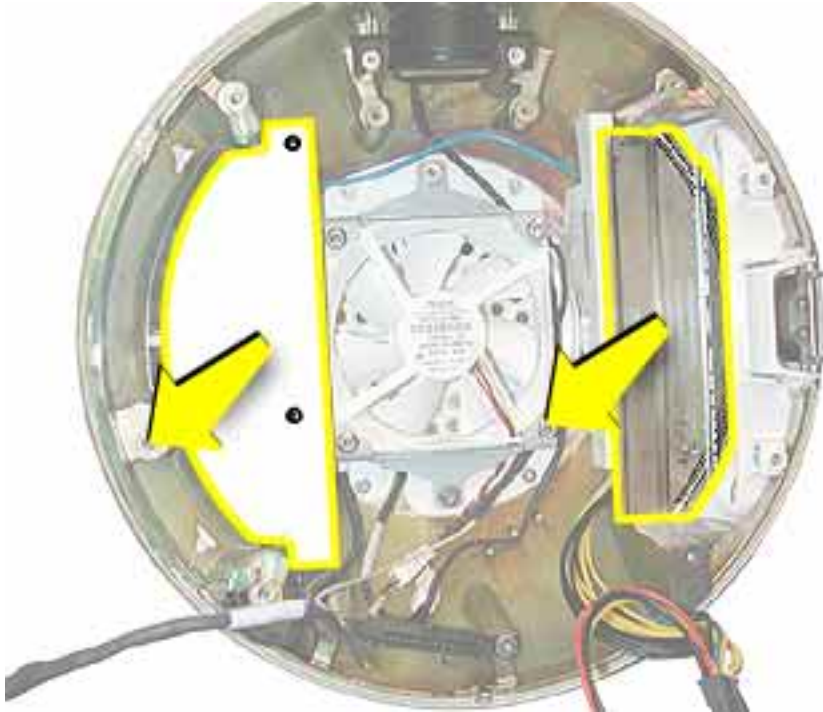

4. **Replacement Note:** When replacing the metal shield (see picture above) that sits on top of the power supply, make certain that the two shorter screws are inserted into the screw holes near the optical door. If the longer screws are inserted by mistake, the screws will scratch the top housing (circled below).



---

**Warning:** Whenever the bottom housing is opened for service, you must do two things:

1. You must clean the original thermal film from all thermal interface mating surfaces, and reapply thermal paste to the mating surfaces on the thermal pipe.
2. You must tighten the four torx screws on the bottom housing to a minimum of 17 in.-lbs. Use a torque driver (service tool 076-0899) to ensure that the thermal pipe is firmly mated with the top base. If you do not have a torque driver, you must make sure the screws are tightened by hand **FIRMLY, BUT NOT FORCIBLY**.

**Warning: Failure to follow these steps could cause the computer to overheat and damage internal components.**

Refer to the topic “Thermal Paste Application” for detailed information.



# Optical Drive Door

## Tools

This procedure requires the following tools:

- Torx-10 screwdriver
- Needlenose pliers

## Part Location



## Preliminary Steps

Before you begin, do the following:

- Position the computer in the service stand.
- Remove the user access plate.
- Remove the bottom housing.
- Remove the drive carrier assembly.

## Procedure

1. Remove the four screws on the DVD shield. Set the shield aside.

**Important:** The two screws near the door hinge are shorter than the other power supply screws. Failure to replace the shorter screws to their correct location will scratch the top housing. See step 4, Replacement Note in the Power Supply section for a picture .



- Slide the optical door guide off the chassis.

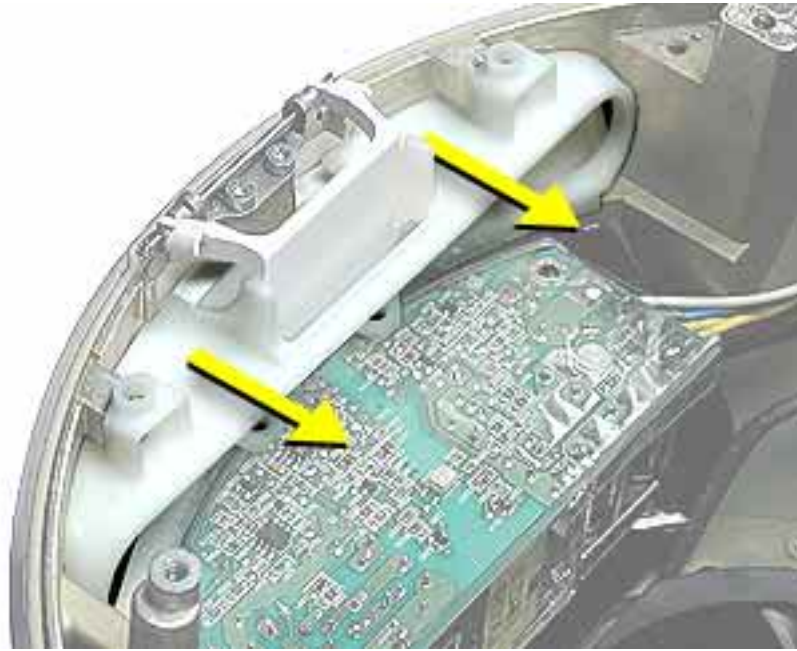

- Carefully remove the two door springs with a needlenose pliers.



4. Remove the door hinge screws.



5. Open the door open.





6. Slide the door and hinge off the frame. Remove the door from the base.



**Warning:** Whenever the bottom housing is opened for service, you must do two things:

1. You must clean the original thermal film from all thermal interface mating surfaces, and reapply thermal paste to the mating surfaces on the thermal pipe.
2. You must tighten the four torx screws on the bottom housing to a minimum of 17 in.-lbs. Use a torque driver (service tool 076-0899) to ensure that the thermal pipe is firmly mated with the top base. If you do not have a torque driver, you must make sure the screws are tightened by hand **FIRMLY, BUT NOT FORCIBLY**.

**Warning: Failure to follow these steps could cause the computer to overheat and damage internal components.**

Refer to the topic “Thermal Paste Application” for detailed information.



# Speaker, Internal

## Tools

This procedure requires the following tools:

- Torx-10 screwdriver

## Part Location

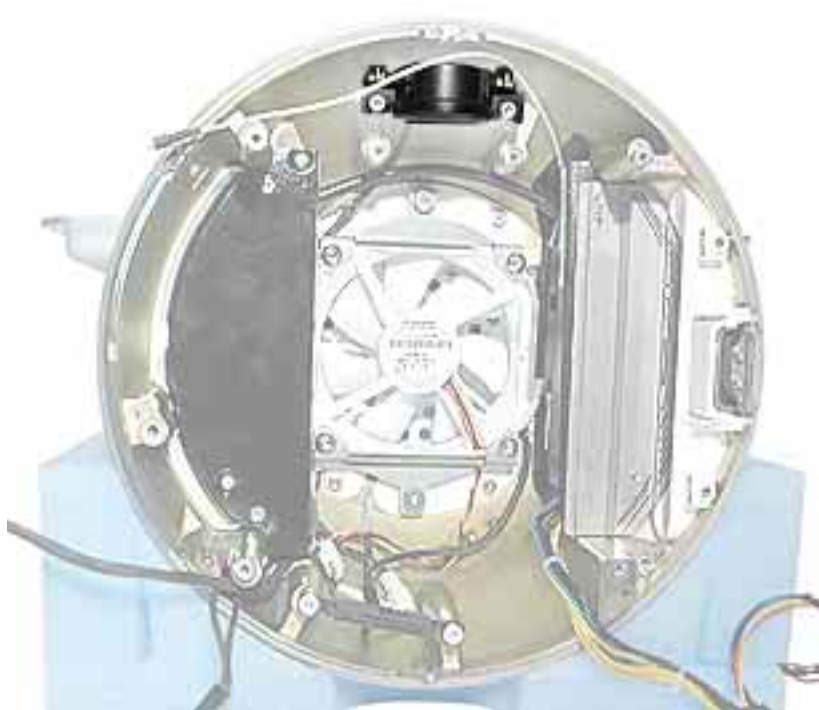

## Preliminary Steps

Before you begin, do the following:

- Position the computer in the service stand.
- Remove the user access plate.
- Remove the bottom housing.
- Remove the drive carrier assembly.

## Procedure

1. Loosen the two screws enough to slide the speaker off the metal posts. Disconnect the speaker cable.



**Warning:** Whenever the bottom housing is opened for service, you must do two things:

1. You must clean the original thermal film from all thermal interface mating surfaces, and reapply thermal paste to the mating surfaces on the thermal pipe.
2. You must tighten the four torx screws on the bottom housing to a minimum of 17 in.-lbs. Use a torque driver (service tool 076-0899) to ensure that the thermal pipe is firmly mated with the top base. If you do not have a torque driver, you must make sure the screws are tightened by hand **FIRMLY, BUT NOT FORCIBLY**.

**Warning: Failure to follow these steps could cause the computer to overheat and damage internal components.**

Refer to the topic “Thermal Paste Application” for detailed information.



# Fan

## Tools

This procedure requires the following tools:

- Torx-15 screwdriver

## Part Location



## Preliminary Steps

Before you begin, do the following:

- Position the computer in the service stand.
- Remove the user access plate.
- Remove the bottom housing.
- Remove the drive carrier assembly.

---

## Procedure

1. Remove the two fan screws and disconnect the fan connector.
2. Lift the fan out of the chassis (Faraday cage). **Note:** The replacement fan includes the mounting bracket.



**Warning:** Whenever the bottom housing is opened for service, you must do two things:

1. You must clean the original thermal film from all thermal interface mating surfaces, and reapply thermal paste to the mating surfaces on the thermal pipe.
2. You must tighten the four torx screws on the bottom housing to a minimum of 17 in.-lbs. Use a torque driver (service tool 076-0899) to ensure that the thermal pipe is firmly mated with the top base. If you do not have a torque driver, you must make sure the screws are tightened by hand **FIRMLY, BUT NOT FORCIBLY**.

**Warning: Failure to follow these steps could cause the computer to overheat and damage internal components.**

Refer to the topic “Thermal Paste Application” for detailed information.



# Power Supply Insulators

## Tools

No tools are required for this procedure.

## Part Location



**Note:** Insulator color and transparency may vary from those shown above.

## Preliminary Steps

Before you begin, do the following:

- Position the computer in the service stand.
- Remove the user access plate.
- Remove the bottom housing.
- Remove the drive carrier assembly.
- Remove the power supply.

---

## Procedure

1. Carefully pull the insulators from the chassis (Faraday cage). These are attached to the chassis with double-sided tape.



**Warning:** Whenever the bottom housing is opened for service, you must do two things:

1. You must clean the original thermal film from all thermal interface mating surfaces, and reapply thermal paste to the mating surfaces on the thermal pipe.
2. You must tighten the four torx screws on the bottom housing to a minimum of 17 in.-lbs. Use a torque driver (service tool 076-0899) to ensure that the thermal pipe is firmly mated with the top base. If you do not have a torque driver, you must make sure the screws are tightened by hand **FIRMLY, BUT NOT FORCIBLY**.

**Warning: Failure to follow these steps could cause the computer to overheat and damage internal components.**

Refer to the topic “Thermal Paste Application” for detailed information.



## Fan Bracket (under fan)

### Tools

This procedure requires the following tools:

- Torx-10 screwdriver

### Part Location



### Preliminary Steps

Before you begin, do the following:

- Position the computer in the service stand.
- Remove the user access plate.
- Remove the bottom housing.
- Remove the drive carrier assembly.
- Remove the power supply.
- Remove the fan.



---

## Procedure

1. Remove the four screws connecting the fan fan bracket to the chassis (Faraday cage).



2. Lift the fan bracket from the chassis. **Note:** The fan gasket is stuck to the back side of the fan bracket.

**Replacement Note:** For reassembly, note the orientation of the neck cables (see below) in the fan bracket:

- **Blue** Blind Mate Connector cable
- **Green** Blind Mate Connector cable
- **Red** TMDS video cable

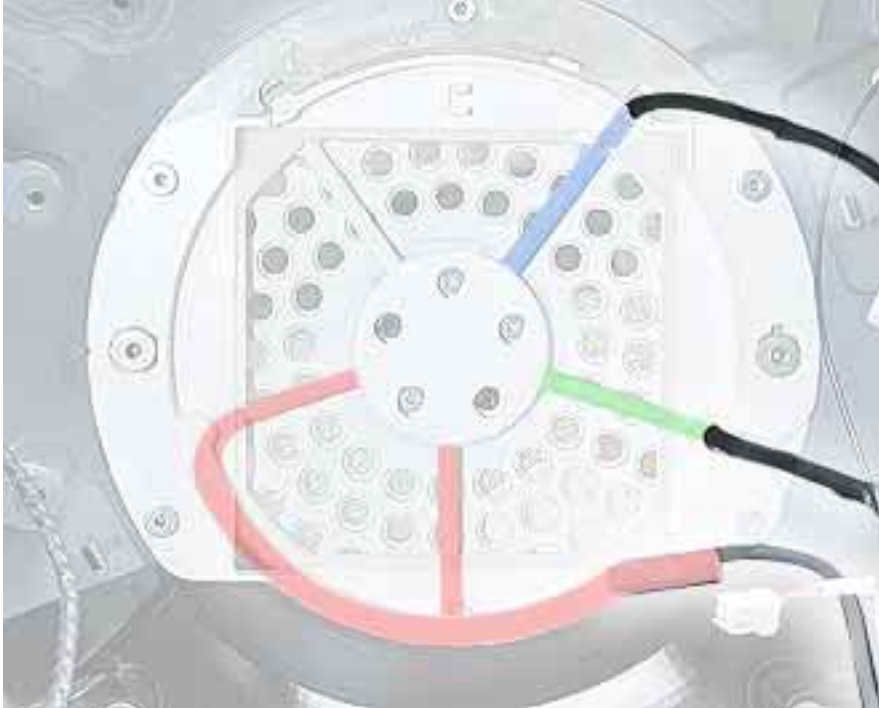

**Warning:** Whenever the bottom housing is opened for service, you must do two things:

1. You must clean the original thermal film from all thermal interface mating surfaces, and reapply thermal paste to the mating surfaces on the thermal pipe.
2. You must tighten the four torx screws on the bottom housing to a minimum of 17 in.-lbs. Use a torque driver (service tool 076-0899) to ensure that the thermal pipe is firmly mated with the top base. If you do not have a torque driver, you must make sure the screws are tightened by hand **FIRMLY, BUT NOT FORCIBLY**.

**Warning: Failure to follow these steps could cause the computer to overheat and damage internal components.**

Refer to the topic “Thermal Paste Application” for detailed information.



# Fan Gasket

## Tools

No tools are required for this procedure.

## Part Location



## Preliminary Steps

Before you begin, do the following:

- Position the computer in the service stand.
- Remove the user access plate.
- Remove the bottom housing.
- Remove the drive carrier assembly.
- Remove the power supply.
- Remove the fan.
- Remove the fan bracket.

---

## Procedure

1. Remove the fan bracket retainer and turn it over. Gently peel the fan gasket off the back of the fan bracket.



**Warning:** Whenever the bottom housing is opened for service, you must do two things:

1. You must clean the original thermal film from all thermal interface mating surfaces, and reapply thermal paste to the mating surfaces on the thermal pipe.
2. You must tighten the four torx screws on the bottom housing to a minimum of 17 in.-lbs. Use a torque driver (service tool 076-0899) to ensure that the thermal pipe is firmly mated with the top base. If you do not have a torque driver, you must make sure the screws are tightened by hand **FIRMLY, BUT NOT FORCIBLY**.

**Warning: Failure to follow these steps could cause the computer to overheat and damage internal components.**

Refer to the topic “Thermal Paste Application” for detailed information.



# Cap, Neck Spoke Retainer

## Tools

This procedure requires the following tools:

- Torx-10 screwdriver

## Part Location



## Preliminary Steps

Before you begin, do the following:

- Position the computer in the service stand.
- Remove the user access plate.
- Remove the bottom housing.
- Remove the drive carrier assembly.
- Remove the power supply.
- Remove the fan.

## Procedure

1. The neck cables are highlighted below. Note the cable routing, including the blind mate connector orientation before removing the cap screws and neck cap.



2. There are five screws on the neck cap; however, only the three silver screws need to be removed. The remaining two black screws keep the neck attached to the base.



3. Lift the neck cap off the cables. The two remaining black screws hold the neck to the base. Note the orientation for neck reassembly.



**Warning:** Whenever the bottom housing is opened for service, you must do two things:

1. You must clean the original thermal film from all thermal interface mating surfaces, and reapply thermal paste to the mating surfaces on the thermal pipe.
2. You must tighten the four torx screws on the bottom housing to a minimum of 17 in.-lbs. Use a torque driver (service tool 076-0899) to ensure that the thermal pipe is firmly mated with the top base. If you do not have a torque driver, you must make sure the screws are tightened by hand **FIRMLY, BUT NOT FORCIBLY**.

**Warning: Failure to follow these steps could cause the computer to overheat and damage internal components.**

Refer to the topic “Thermal Paste Application” for detailed information.



# Blind Mate Connector

## Tools

This procedure requires the following tools:

- Torx-10 screwdriver

## Part Location

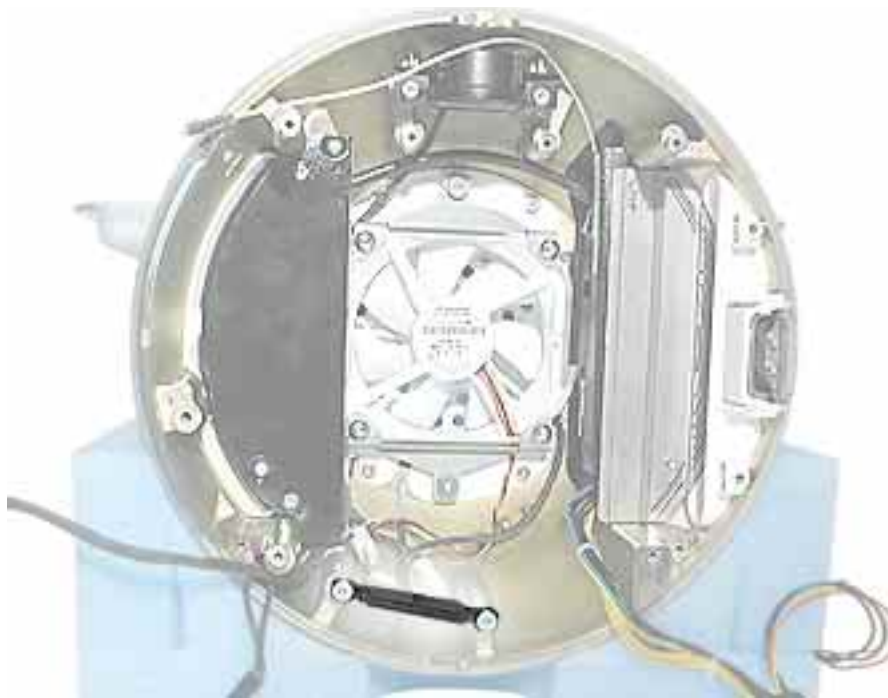

## Preliminary Steps

Before you begin, do the following:

- Position the computer in the service stand.
- Remove the user access plate.
- Remove the bottom housing.
- Remove the drive carrier assembly.
- Remove the power supply.
- Remove the fan.
- Remove the fan bracket.
- Remove the neck spoke retainer cap.



## Procedure

1. Remove the two screws.
2. Lift the blind mate connector off the chassis. **Note:** The blind mate connector is part of the neck assembly.

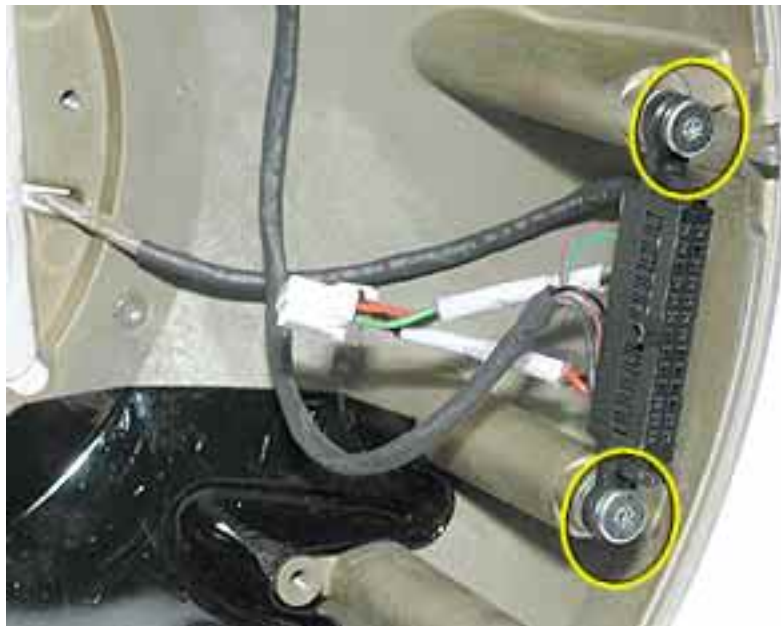

### Replacement Notes:

**Blind Mate Connector:** Make sure to replace the connector into the chassis with the tab on the blind mate connector facing inward (toward the fan). And, when tightening the screws, the blind mate connector should have some play; do not tighten down so it doesn't move at all.

**Warning:** Whenever the bottom housing is opened for service, you must do two things:

1. You must clean the original thermal film from all thermal interface mating surfaces, and reapply thermal paste to the mating surfaces on the thermal pipe.
2. You must tighten the four torx screws on the bottom housing to a minimum of 17 in.-lbs. Use a torque driver (service tool 076-0899) to ensure that the thermal pipe is firmly mated with the top base. If you do not have a torque driver, you must make sure the screws are tightened by hand **FIRMLY, BUT NOT FORCIBLY**.

**Warning: Failure to follow these steps could cause the computer to overheat and damage internal components.**

Refer to the topic "Thermal Paste Application" for detailed information.



# Chassis (Faraday Cage)

## Tools

This procedure requires the following tools:

- Torx-10 screwdriver
- Torx-8 screwdriver for the logo screw

## Part Location



## Preliminary Steps

Before you begin, do the following:

- Position the computer in the service stand.
- Remove the user access plate.
- Remove the bottom housing.
- Remove the drive carrier assembly.
- Remove the power supply.
- Remove the power supply insulators.

- Remove the optical drive door.
- Remove the internal speaker.
- Remove the fan.
- Remove the fan bracket.
- Remove the neck spoke retainer cap.
- Remove the blind mate connector screws.

## Procedure

1. Remove the three screws in the base of the Faraday cage. The screw at the top of the picture is the logo screw (T-8), located under the insulator (which may already be removed).



2. Separate and lift the Faraday cage away from the outer housing. Be careful not to scratch the white plastic housing. **Important:** The Faraday cage is very heavy and has sharp edges; handle with care.
3. Remove neck cables and the plastic retaining ring that sits on top of the Faraday cage.



### Replacement Notes:

4. **Faraday cage:** Look at the exploded view diagram during reassembly. First, attach the Faraday top cover to the top (OUTSIDE) of the Faraday cage **as shown below**; the Faraday top cover is keyed. Next, thread the neck cables through the hole in the Faraday cage and install the Faraday cage into the top plastic housing. Replace the three screws that hold the plastic housing to the chassis. Attach two neck cap screws to connect the neck to the chassis. Then route the neck cables correctly in the base and replace the fan bracket retainer and three remaining cap screws.

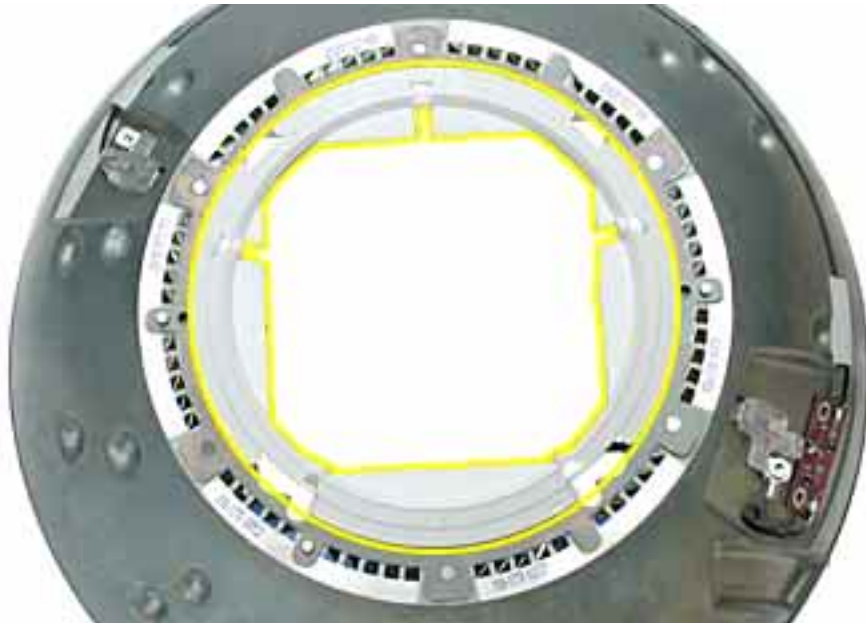

**Warning:** Whenever the bottom housing is opened for service, you must do two things:

1. You must clean the original thermal film from all thermal interface mating surfaces, and reapply thermal paste to the mating surfaces on the thermal pipe.
2. You must tighten the four torx screws on the bottom housing to a minimum of 17 in.-lbs. Use a torque driver (service tool 076-0899) to ensure that the thermal pipe is firmly mated with the top base. If you do not have a torque driver, you must make sure the screws are tightened by hand **FIRMLY, BUT NOT FORCIBLY**.

**Warning:** Failure to follow these steps could cause the computer to overheat and damage internal components.

Refer to the topic “Thermal Paste Application” for detailed information.



# AirPort Antenna

## Tools

This procedure requires the following tools:

- Torx-8 screwdriver

## Part Location



## Preliminary Steps

Before you begin, do the following:

- Position the computer in the service stand.
- Remove the user access plate.
- Remove the bottom housing.
- Remove the drive carrier assembly.
- Remove the power supply.
- Remove the power supply insulators.
- Remove the optical drive door.
- Remove the internal speaker.
- Remove the fan.

- Remove the fan bracket under the fan.
- Remove the neck spoke retainer cap.
- Remove the blind mate connector screws.
- Remove the Faraday cage.

## Procedure

1. Remove the mounting screw and unclip each of two antenna boards from the Faraday cage. Remove any tape, and carefully separate the antenna board cable from the Faraday cage.

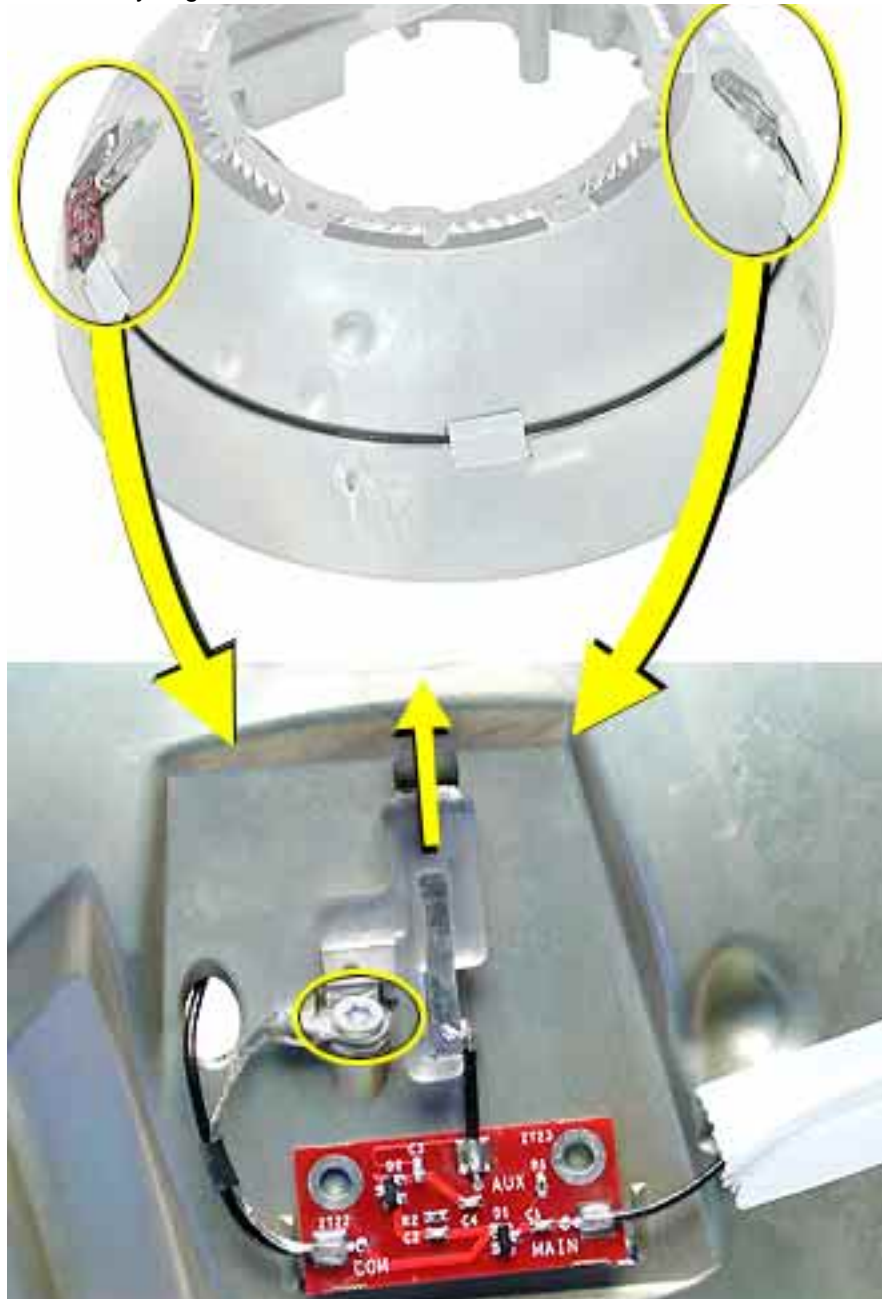

---

**Warning:** Whenever the bottom housing is opened for service, you must do two things:

1. You must clean the original thermal film from all thermal interface mating surfaces, and reapply thermal paste to the mating surfaces on the thermal pipe.
2. You must tighten the four torx screws on the bottom housing to a minimum of 17 in.-lbs. Use a torque driver (service tool 076-0899) to ensure that the thermal pipe is firmly mated with the top base. If you do not have a torque driver, you must make sure the screws are tightened by hand **FIRMLY, BUT NOT FORCIBLY**.

**Warning: Failure to follow these steps could cause the computer to overheat and damage internal components.**

Refer to the topic “Thermal Paste Application” for detailed information.





# Housing, Outer Shell, Plastic

## Tools

This procedure requires the following tools:

- Torx-10 screwdriver

## Part Location



## Preliminary Steps

Before you begin, do the following:

- Position the computer in the service stand.
- Remove the user access plate.
- Remove the bottom housing.
- Remove the drive carrier assembly.
- Remove the power supply.
- Remove the power supply insulators.
- Remove the optical drive door.
- Remove the fan.
- Remove the fan bracket under the fan.

- 
- Remove the neck spoke retainer cap.
  - Remove the blind mate connector screws.
  - Remove the Faraday cage.

## Procedure

1. If necessary, remove the two black screws from the vent cap.



2. Carefully, pull the neck cables through the hole on the vent cap shown below. Start with the blind mate connector and cables, then the long video cable. **Important:** Be careful not to scratch the white paint on the inside of the housing shell, the vent cap, and the neck cable spokes.



3. Next, carefully pull the neck cables through the hole in the plastic housing. **Note:** Turn the blind mate connector vertically to pull it through the hole.



**Warning:** Whenever the bottom housing is opened for service, you must do two things:

1. You must clean the original thermal film from all thermal interface mating surfaces, and reapply thermal paste to the mating surfaces on the thermal pipe.
2. You must tighten the four torx screws on the bottom housing to a minimum of 17 in.-lbs. Use a torque driver (service tool 076-0899) to ensure that the thermal pipe is firmly mated with the top base. If you do not have a torque driver, you must make sure the screws are tightened by hand **FIRMLY, BUT NOT FORCIBLY**.

**Warning: Failure to follow these steps could cause the computer to overheat and damage internal components.**

Refer to the topic "Thermal Paste Application" for detailed information.



# Display, Flat Panel

## Tools

This procedure requires the following tools:

- 1.5 mm hex tool
- Torx-10 screwdriver

**Important:** If you are replacing the display, be sure to install the new display shield and EMI gaskets that come with the new LCD panel. Installation instructions are included with the new display panel

## Part Location



## Preliminary Steps

Before you begin, do the following:

- Position the computer in the service stand.

---

## Procedure

1. Remove three screws that connect the back cover to the flat panel LCD display.



- 
2. Support the back cover and pull back the display (as shown) to separate it from the base.



3. **Caution:** The power on LED cable (labelled A below) is fragile. When disconnecting display cables in the following steps, be sure to raise the TOP SIDE of the display only.
4. Carefully raise the TOP SIDE of the display just enough to access the inverter connector (B below) and the TMDS cables (C below). Disconnect the inverter cable and remove the TMDS cables from the metal cable clip.



5. Raise the display to access the TMDS connector. Peel back the black tape and disconnect the TMDS connector, which is located beneath the tape.





---

**Caution:** The power on LED cable (labelled A below) is fragile. Use care when disconnecting it and do not raise the bottom side of the display.

6. Raise the top of the display to access the power on LED (A below) and microphone (B below) cables. Peel back the tape and disconnect the cables.

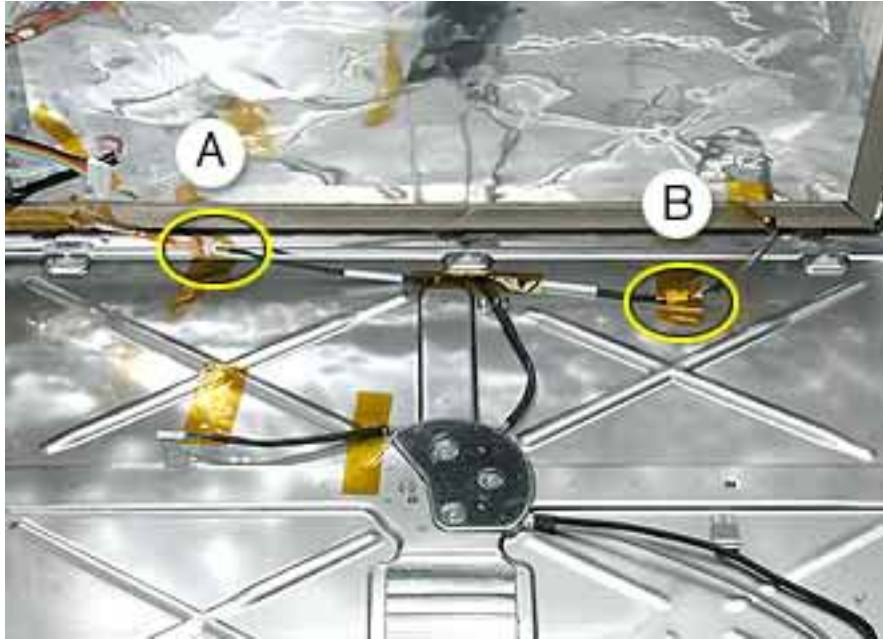

7. Remove four screws that connect the LCD display panel to the display bezel.



8. Remove the display from the bezel.  
**Replacement Note:** If you are replacing the display, be sure to install the new display shield and EMI gaskets that come with the new LCD panel. Installation instructions are included with the new display panel.



9. Remove the inverter (refer to the next procedure) from the display.



# Inverter

## Tools

This procedure requires no tools.

## Part Location



## Preliminary Steps

Before you begin, do the following:

- Position the computer in the service stand.
- Remove the flat panel display.

## Procedure

1. Slightly peel back the edge of the EMI shield and copper shielding as shown (step 1 below). Remove the inverter shield from the inverter (step 2 below).

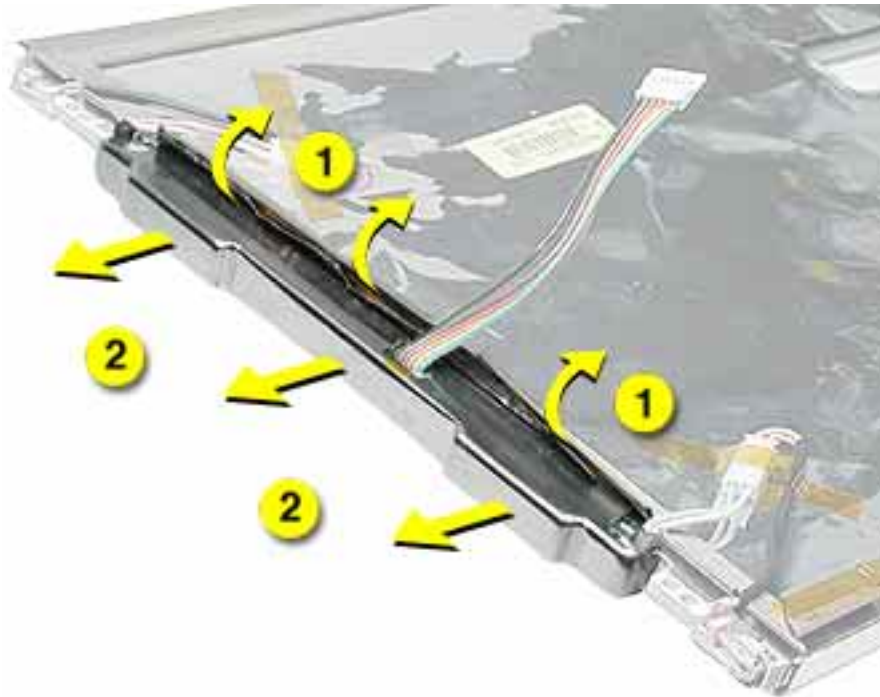

2. Remove tape and disconnect the two inverter cables (step 3 below). Pull the inverter off the edge of the display panel (step 4 below).

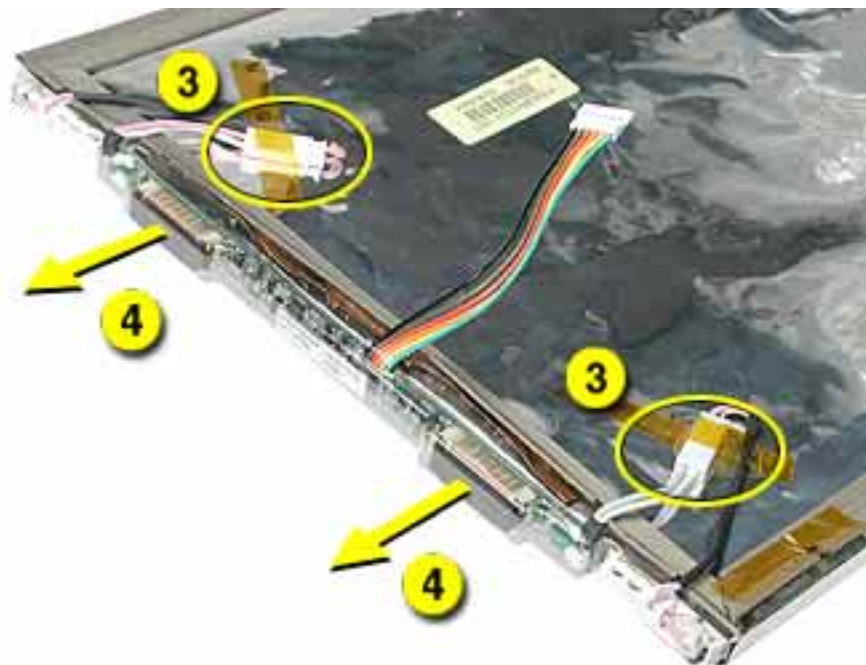



# Back Cover, Display

## Tools

This procedure requires the following tools:

- Torx-10 screwdriver

## Part Location



## Preliminary Steps

Before you begin, do the following:

- Position the computer in the service stand.
- Remove the flat panel display.

## Procedure

1. Note the position of the inverter (A), TMDS (B), microphone (C), and LED (D) cables. Remove four screws that secure the metal wire deflector and the base assembly to the back cover. Remove the wire deflector.

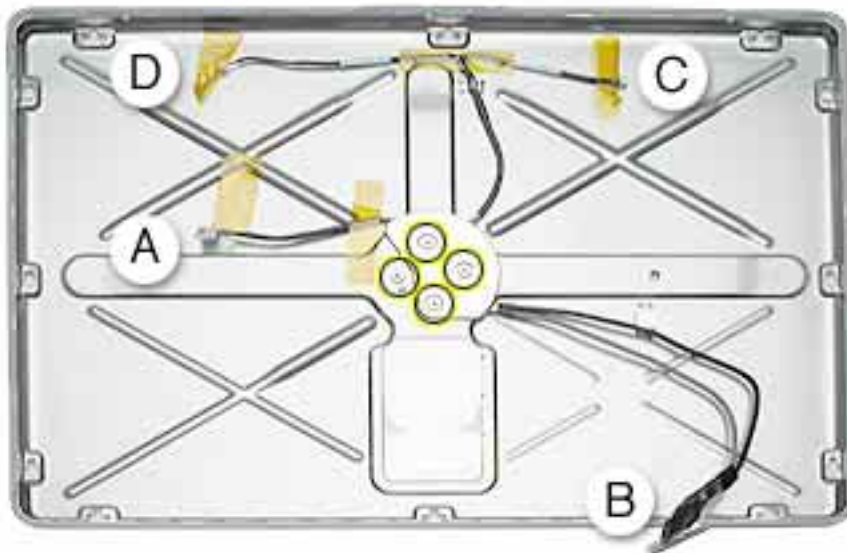

2. Remove tape from the neck cables and pull them through the hole in the back cover. **Note:** The hole in the back cover is notched; align the wide TMDS connector with these notices to pull it through the back cover.

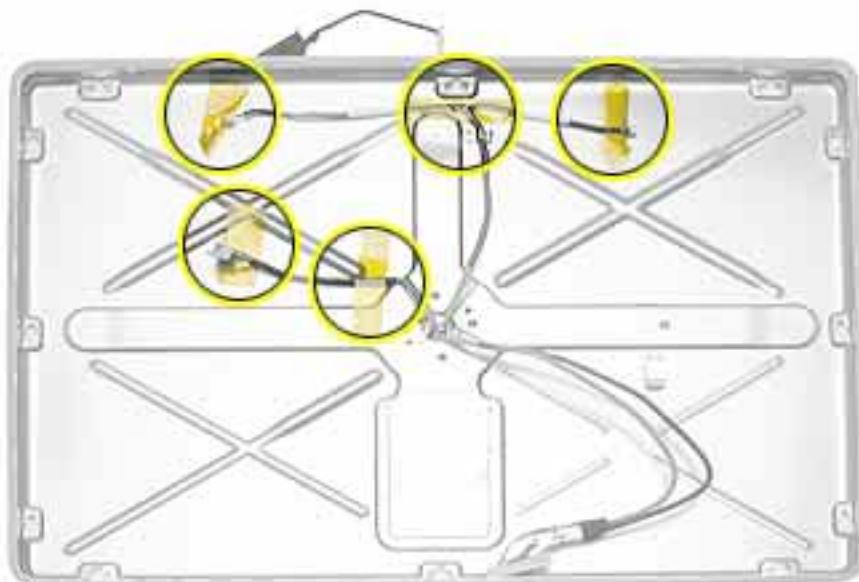



# Neck Assembly

## Tools

This procedure requires the following tools:

- Torx-10 screwdriver

## Part Location



## Preliminary Steps

Before you begin, do the following:

- Position the computer in the service stand.
- Remove the user access plate.
- Remove the bottom housing.
- Remove the drive carrier assembly.
- Remove the power supply.
- Remove the power supply insulators.
- Remove the fan.

- 
- Remove the fan bracket.
  - Remove the neck spoke retainer cap.
  - Remove the blind mate connector screws.
  - Remove the Faraday cage.
  - Remove the outer plastic housing.
  - Remove the flat panel display.
  - Remove the back cover

## Procedure

The neck assembly is attached to the computer base at one end and to the flat panel display at the other end. To remove the neck assembly from the computer, follow all the take-apart procedures. When you are finished, you will be left with the neck assembly shown below.







Troubleshooting  
iMac (17-inch Flat Panel)



# General Information

## What's New and Different:

1. **Important:** If you are replacing the display, be sure to install the new display shield and EMI gaskets that come with the new LCD panel. Installation instructions are included with the new display panel. Additional display shields/gasket kits are also available separately as a kit, part #076-0958.
2. Diagnostic test points have been added to the logic board. They are accessed through the user access door. Use the test points to check the following:
  - Battery
  - 5V
  - Main
  - 12V

For more information, refer to the “Logic Board Battery” and “No Power” topics later in this chapter.

3. **Important:** The CPU uses a thermal pipe to transfer heat away. This pipe makes a thermal connection to the top metal chassis (Faraday cage) at **two** locations. These connecting points must be cleaned and have new thermal paste applied each time the bottom housing is removed. If the mating surfaces are not cleaned and thermal paste is not used, the CPU may overheat and become damaged. There is no exception to this. **Note:** Most service procedures require that the bottom housing is removed.

Refer to “Thermal Paste Application” mentioned later in this chapter or in the Take Apart chapter.

4. The procedures for removing and replacing the display panel and the inverter board are new and different. Refer to the Take Apart chapter for additional information. **Important:** Whenever the LCD display (661-2715) is replaced, a display shield/gasket kit (076-0958) must be installed on the new panel. Instructions for installing the shield/gasket kit are included with the new LCD panel.
5. The AirPort antenna cable is no longer bundled in the neck assembly. The antenna is now clipped to the outside of the Faraday cage. Refer to the Take Apart chapter for additional information.

## Important Things to Remember:

Service items that still apply to all flat-panel iMac computers:

1. **Important:** Whenever the logic board is separated from the bottom housing, you must install new thermal pads to three surfaces on the bottom housing. The thermal pads help cool components on the logic board. Failure to apply these pads whenever the logic board is separated from the bottom housing could cause these parts to overheat. Short term separation, where the thermal pads are not handled

---

excessively ( an exception would be if you are simply testing the logic board and only detach it for a few minutes), does not require replacement. Refer to “Thermal Pad Installation” in this chapter for detailed information.

Refer to the Take Apart chapter, “Thermal Pad Installation.”

2. Whenever the bottom housing is opened for service, you must do two things:
  1. You must clean the original thermal film from the surfaces joining the thermal interface layer and reapply thermal paste to the thermal pipe.
  2. You must tighten the four torx screws on the bottom housing to a minimum of 17 in.-lbs. If you do not have a torque driver, you will have to make sure these screws are tightened by hand **FIRMLY, BUT NOT FORCIBLY**. Or, purchase the service tool (076-0899) in order to ensure the thermal pipe is firmly mated with the top base. If the bottom housing is not securely attached to the base in this fashion, the CPU may overheat and become damaged. Failure to follow either of these steps could cause the computer to overheat and damage internal components.

Refer to the topic, “Thermal Paste Application” for detailed information.

3. Special service tools are required to perform some procedures. A service stand, 076-0898, to hold the unit during take apart, and service cables, 076-0897, that allow the unit to be powered on while the bottom housing is open. **Important:** The unit should not be powered on for more than five minutes with the bottom housing open. If it is open longer, the CPU may overheat and become damaged.

## Logic Board, Top

**Note:** Enlarge the page to view the graphic at a larger size.

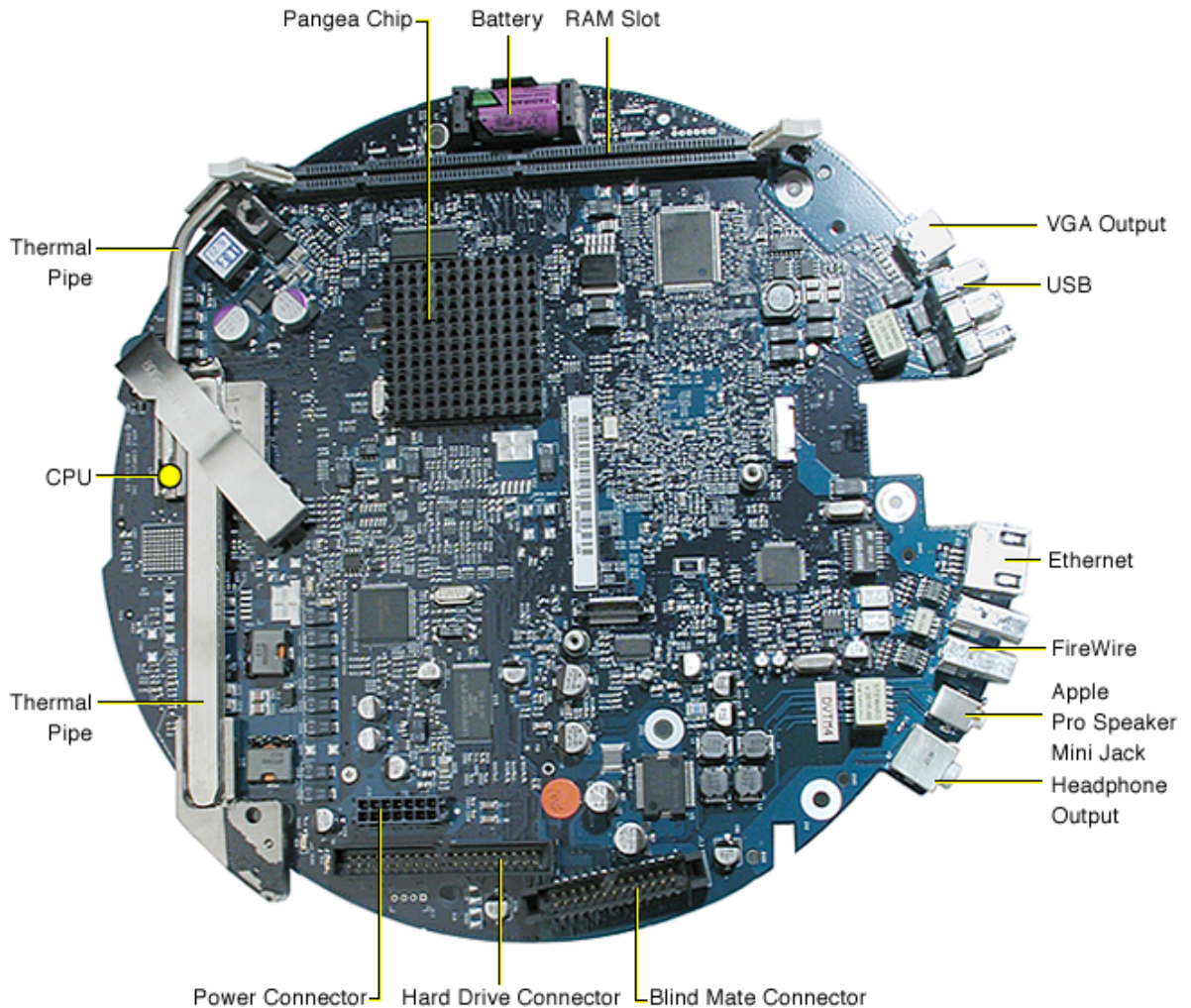

## Logic Board, Bottom

**Note:** Enlarge the page to view the graphic at a larger size.

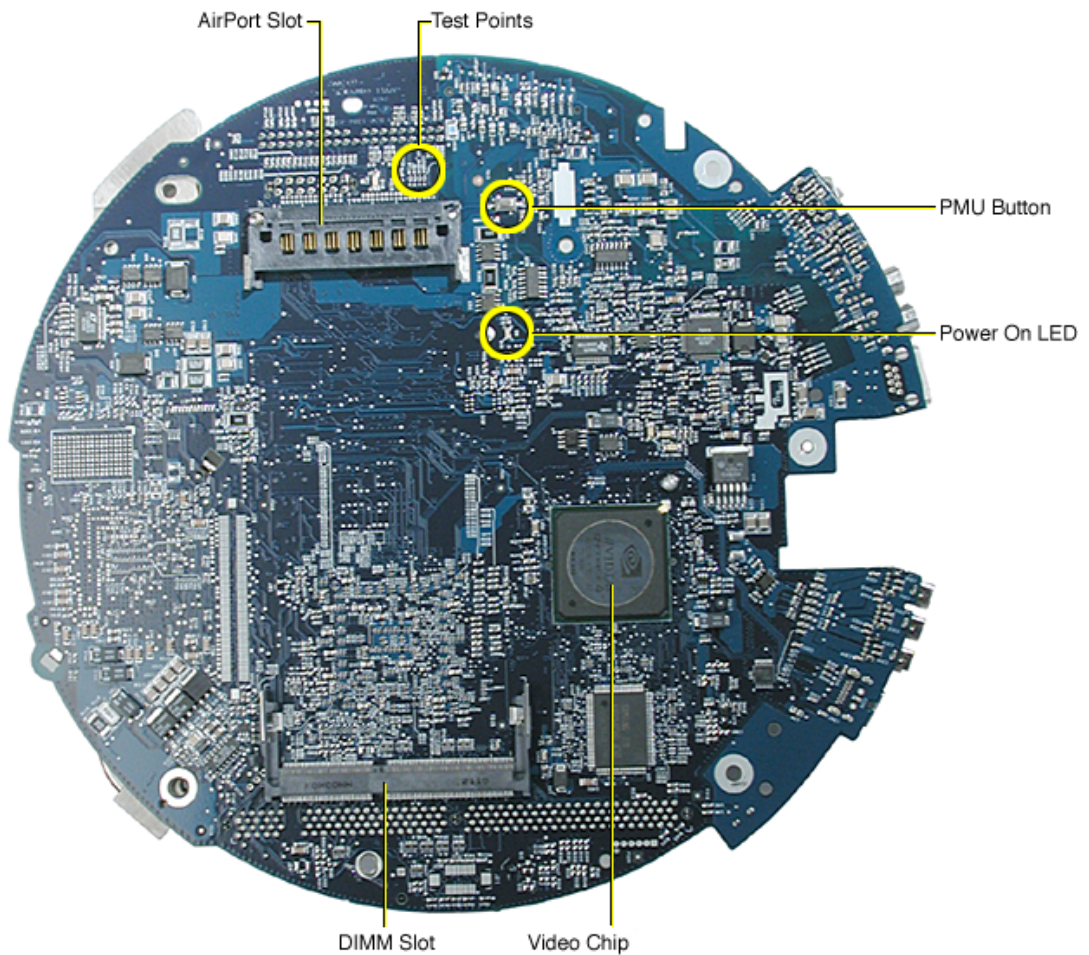

## I/O Ports

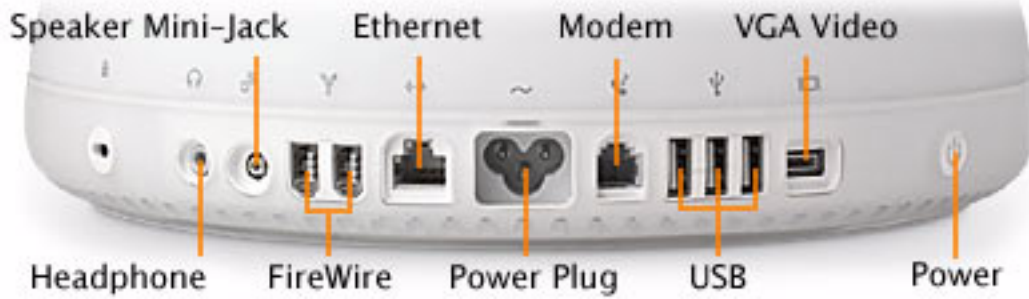

## Service Cables

Three extension cables (076-0897) are required when troubleshooting the iMac with the bottom housing open, as shown below.

Connect the cables as shown below.

A= power cable

B= drive data cable

C= blind mate connector

**Note:** Enlarge the page to view the graphic at a larger size.

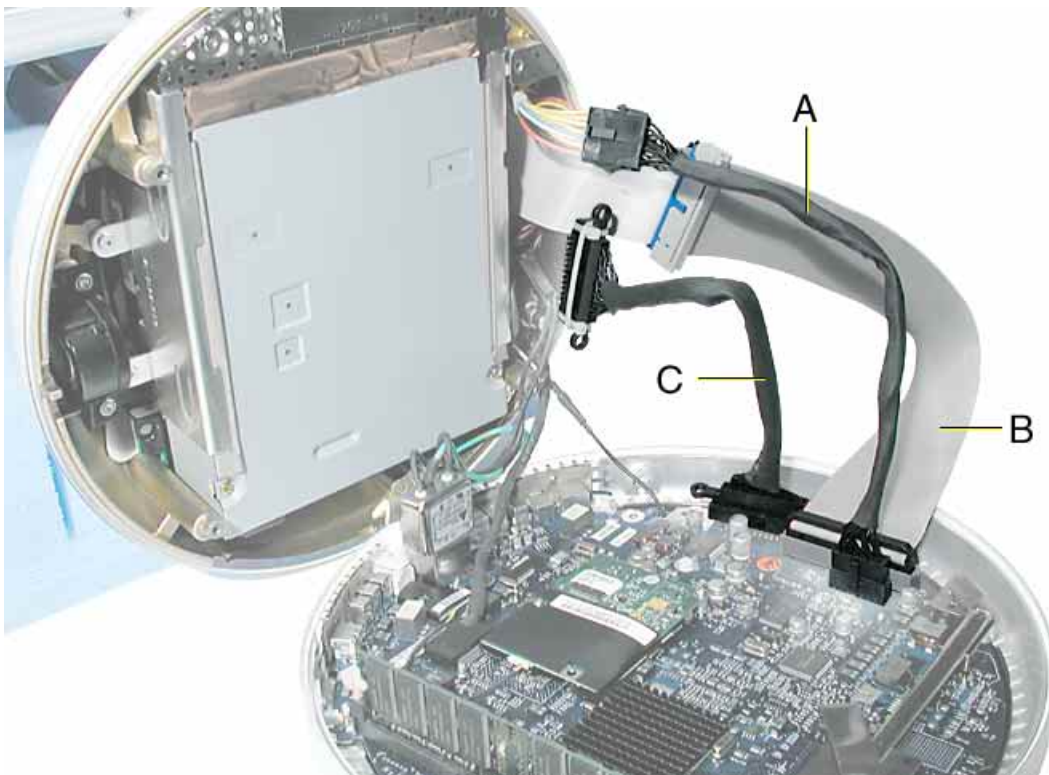

## The PMU Chip

The PMU (Power Management Unit) is a microcontroller chip that controls all power functions for the computer. The PMU (location shown below) is a computer within a computer. It has memory, software, firmware, I/O, two crystals, and a CPU. Its function is to:

- Tell the computer to turn on, turn off, sleep, wake, idle, etc.
- Manage system resets from various commands.
- Maintain parameter RAM (PRAM).
- Manage the real-time clock.

**Important:** The PMU is **very** sensitive and touching the circuitry on the logic board can cause the PMU to crash. If the PMU crashes, the battery life goes from about five years to about two days if the PMU is not reset. Refer to the next topic, “Resetting the PMU on the Logic Board” for the procedure.

Many system problems can be resolved by resetting the PMU chip. The PMU reset button is located on the right side of the board, refer to the picture below.

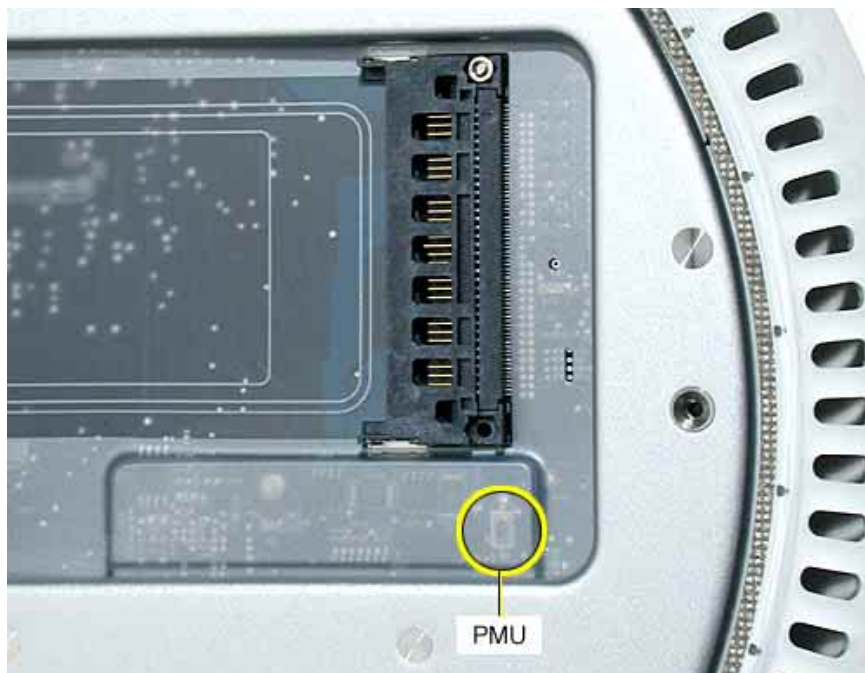

**Location of the PMU Button**

---

## Resetting the PMU on the Logic Board

Resetting the PMU (Power Management Unit) on the logic board can resolve many system problems. Whenever you have a unit that fails to power up, you should follow this procedure before replacing any modules.

1. Disconnect the power cord.
2. Remove the user access panel from the bottom of the computer.
3. Press the PMU reset switch (shown below) once on the bottom side of the logic board and then proceed to step 3. Do **NOT** press the PMU reset switch a second time because it could crash the PMU chip.

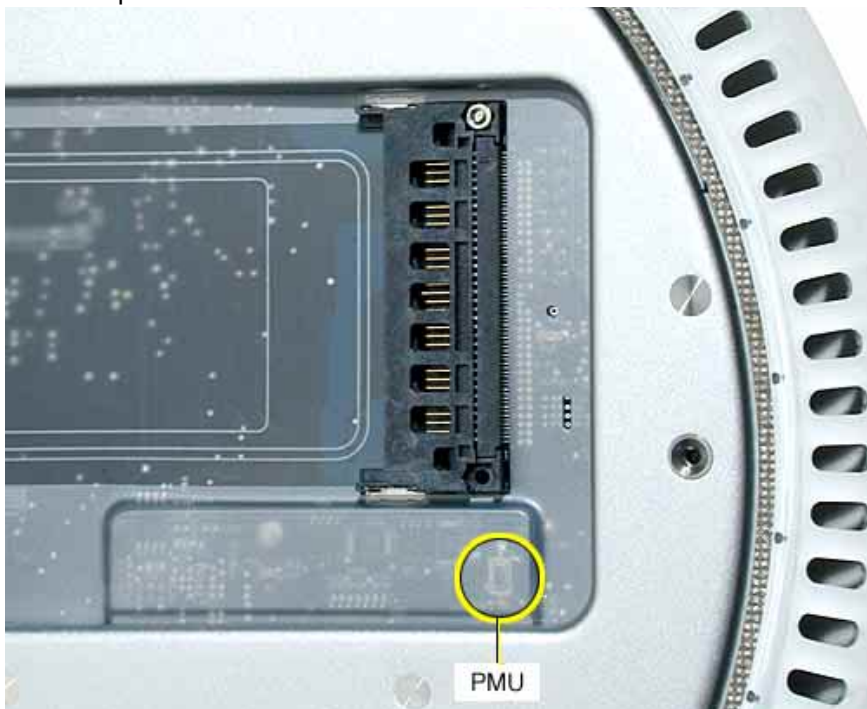

4. WAIT ten seconds before connecting the power cord and powering the computer on. If the computer powers on, go to the next step. If the computer does not power on, there is something else wrong with the computer, refer to the symptom/cure, “No Power” in this chapter.
5. Run MacTest Pro and return the computer to the customer.

**Note:** This entire procedure resets the computer’s PRAM. Be sure to reset the computer’s time, date and other system parameter settings before returning the computer to the customer.



## Diagnostic Test Points

The iMac (17-inch Flat Panel) has four test points and one ground pad on the bottom of the logic board. These test points are accessible under the customer access panel via two small cutouts in the plastic shielding (see below).

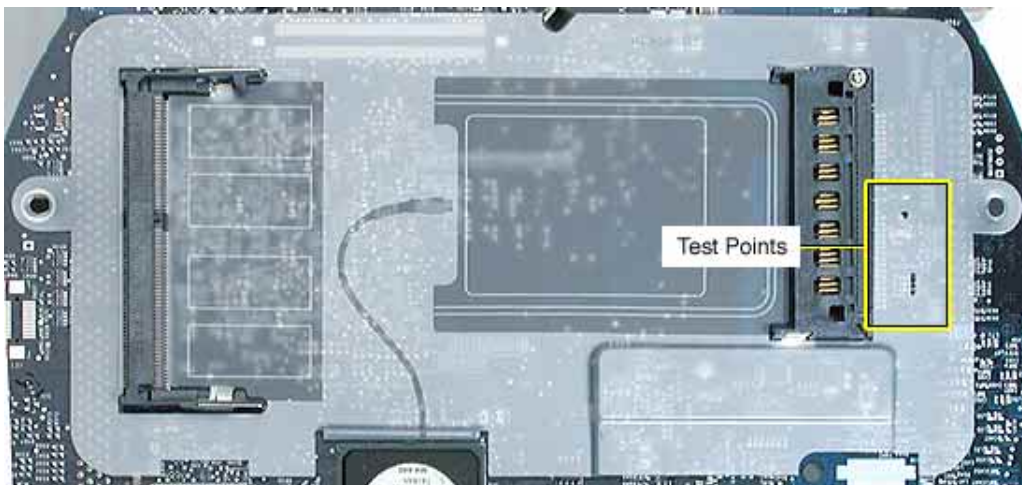

These test points provide an easy troubleshooting tool for common problems. To use each test point, put the positive probe of your voltmeter on the test point, and the negative probe on the ground pad.

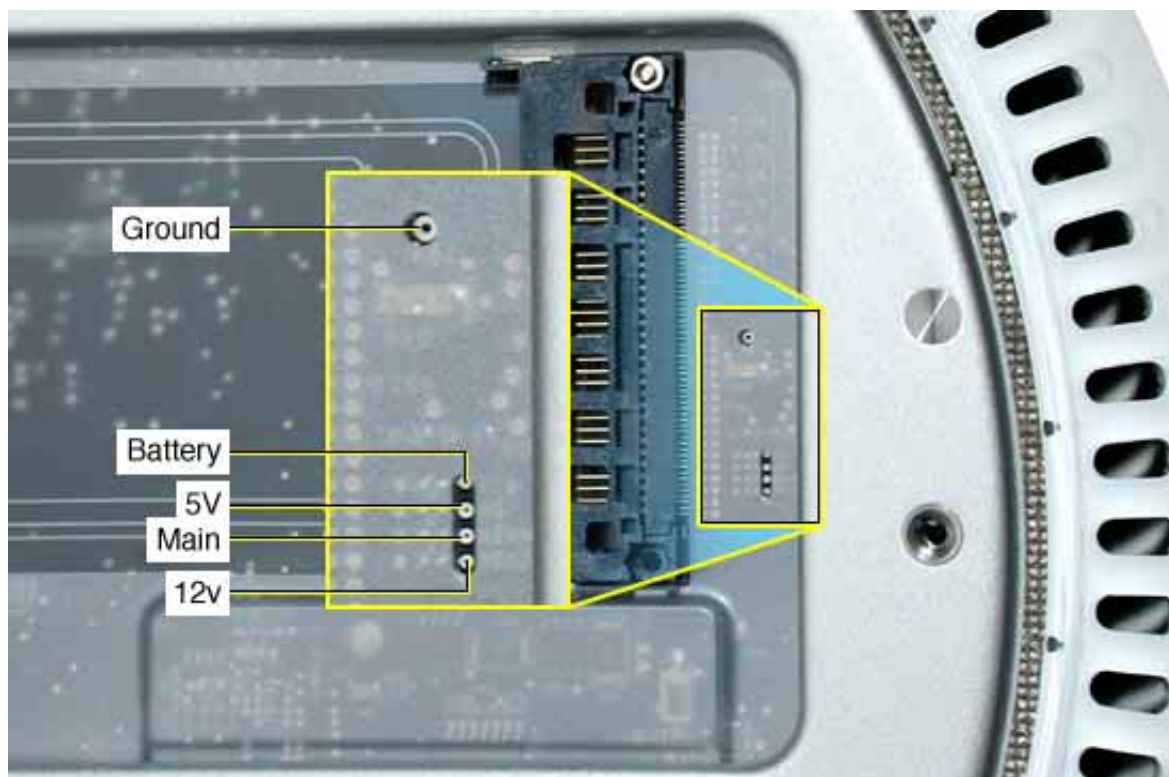

## Logic Board Battery

**Important:** Apple highly recommends removing the battery when handling the logic board. Make sure to use proper ESD protection when handling modules.

The battery on the logic board controls the stored system settings, such as date and time. It is only necessary to test the battery when you can't power on the computer, or the date and time are reset every time the AC power is removed.

The battery is also used to power the PMU chip (because the PMU chip keeps time and must always be running) when the computer is unplugged from the wall (AC power). The PMU is **very** sensitive and touching any circuitry that is connected to the PMU can cause it to crash. If the PMU crashes, the battery life goes from about five years to about two days if the PMU is not reset. Once the battery goes dead, the PMU will reset the time and date every time the AC power is removed. To fix this situation, replace the battery and reset the PMU (refer to “Resetting the PMU on the Logic Board” mentioned earlier in this chapter).

If the computer has a “No Power” situation, check the battery before replacing modules.

### Testing the Battery

1. Remove the user access door on the bottom of the computer.
2. Locate the battery test point.

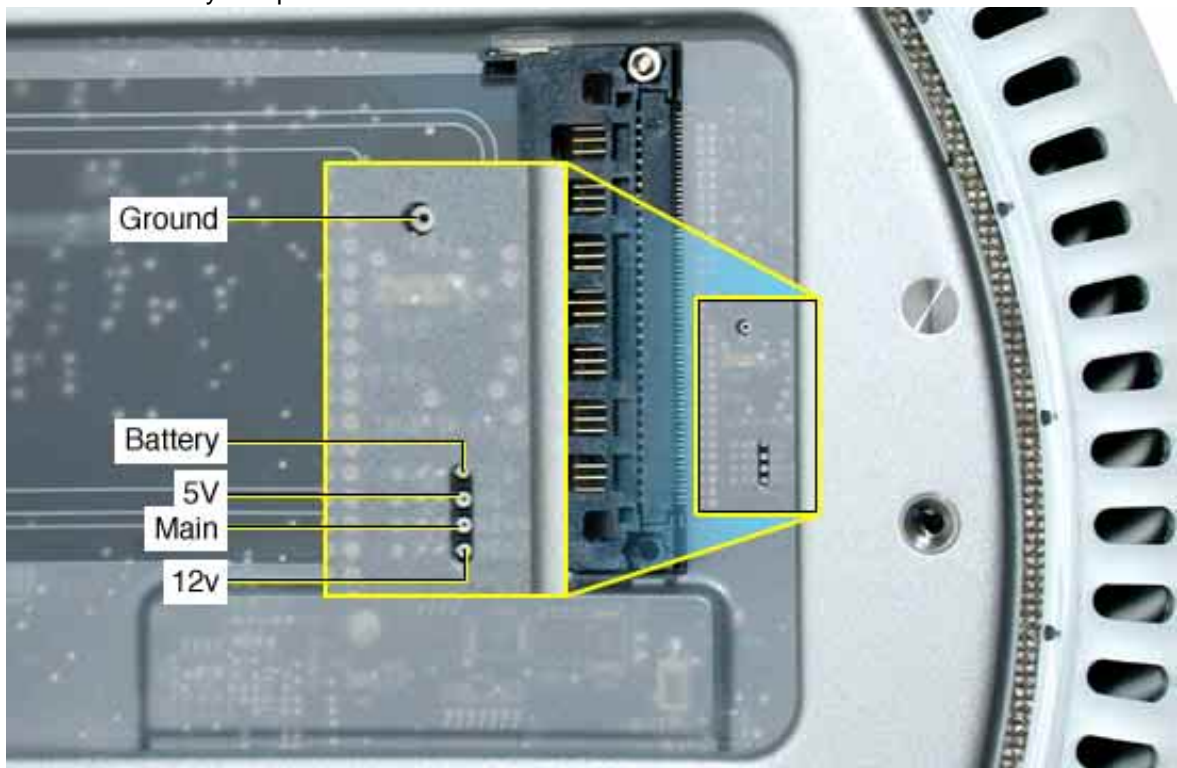

3. With the computer powered off, measure the battery voltage. Does the battery measure at least +3.5v? If no, replace the battery and reset the PMU. If the battery measures +3.5v or higher, reinstall the battery and reset the PMU as above.

---

4. Connect the power cord and power up the system again.

**Warning:** Whenever the bottom housing is opened for service, you must do two things:

1. You must clean and reapply thermal paste to the thermal pipe surface.
2. You must tighten the four torx bolts on the base unit to a minimum of 17 in.– lbs. Failure to follow either of these steps could cause the computer to overheat and damage internal components.

Refer to the next topic, “Thermal Paste Application” for detailed information.

---

## Thermal Paste Application

The following instructions explain how to apply thermal paste to the thermal pipe in the iMac (17-inch Flat Panel) computer. Failure to follow these instructions could cause the computer to overheat and damage internal components.

### Tools

This procedure requires the following tools:

- Plastic stylus or plastic spatula to remove the old thermal paste
- Plastic stylus or plastic spatula to spread the thermal paste
- Thermal paste (922-4757)

### Paste Location



## Procedure

1. Thoroughly clean the original thermal film from the four mating surfaces circled below. Use a plastic stylus to scrape the surfaces clean. **Note:** Do not use an abrasive material or liquid cleaner.

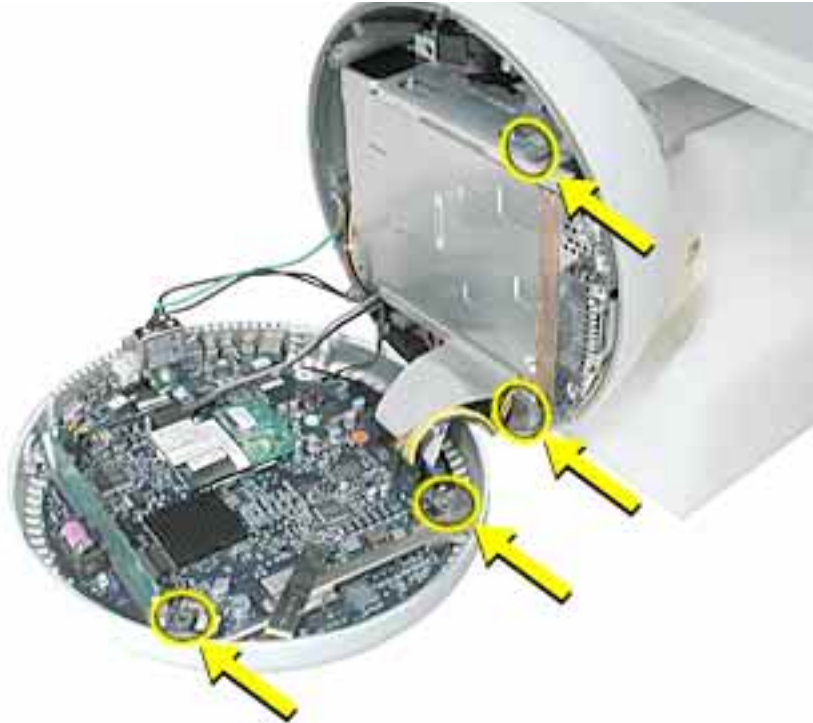

2. Squeeze a drop of thermal paste onto the thermal pipe locations circled below.

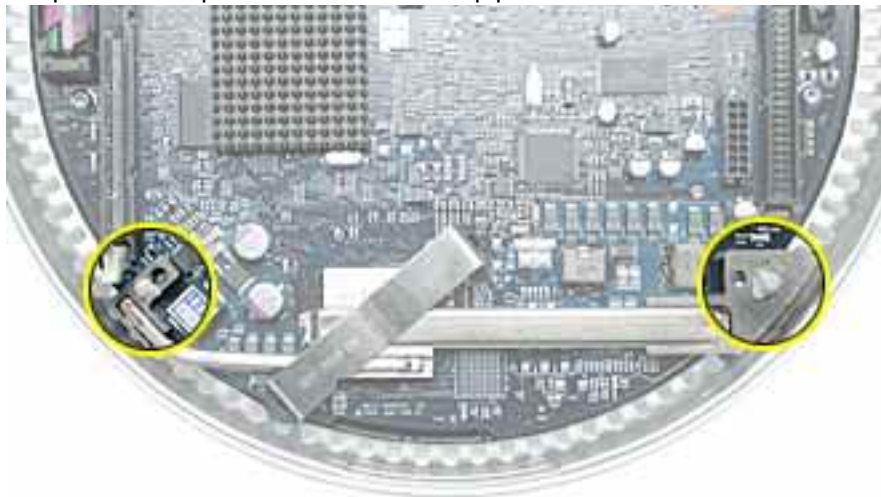

3. Close the bottom housing.

**Warning:** The bottom housing has four torx screws that must be tightened to at least 17 in.-lbs. If you do not have a torque driver, you will have to make sure these screws are tightened by hand **FIRMLY, BUT NOT FORCIBLY**. Or, purchase the service tool (076-0899) in order to ensure the thermal pipe is firmly mated with the top base. If the bottom housing is not securely attached to the base in this fashion, the CPU may overheat and become damaged.

---

## Thermal Pad Replacement Instructions

Whenever the logic board is separated from the bottom housing, you must install new thermal pads to three surfaces on the bottom housing. The thermal pads help cool components on the logic board. Failure to apply these pads whenever the logic board is separated from the bottom housing could cause these parts to overheat. Short term separation, where the thermal pads are not handled excessively ( an exception would be if you are simply testing the logic board and only detach it for a few minutes), does not require replacement.

### Procedure

1. Remove the old thermal pads (circled below) from the bottom housing. Thoroughly clean the bottom housing surfaces after removing the pads. **Note:** If you don't see all three thermal pads on the bottom housing, check the bottom side of the logic board.

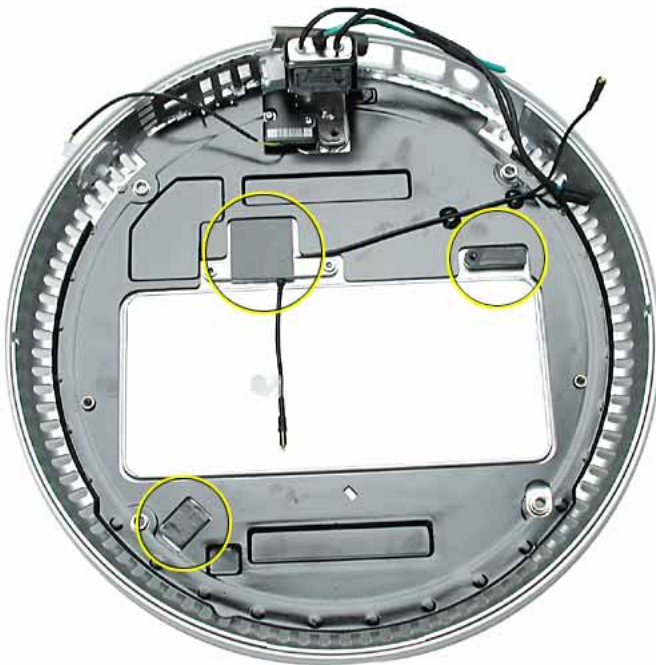

2. Using the thermal pad kit, remove the clear protective backing from the new thermal pads.
3. Place the new thermal pads in the bottom housing. **Note:** Avoid unnecessary contact with either side of the thermal pad as dirt and body oils reduce the thermal pad's conductivity.
4. Press down on the blue protective backing to make sure each thermal pad has even contact with the bottom housing. There should be no air pockets.
5. Remove the blue protective backing from the new thermal pads.
6. Replace the logic board. Holding the logic board by the battery retainer and the internal drive cable connector, slide the logic board back into the bottom housing (make sure the I/O port covers are on the logic board).



# Symptom Charts

## How to Use the Symptom Charts

The Symptom Charts included in this chapter will help you diagnose specific symptoms related to the product. Because cures are listed on the charts in the order of most likely solution, try the cures in the order presented. Verify whether or not the product continues to exhibit the symptom. If the symptom persists, try the next cure.

**Note:** If you have replaced a module, reinstall the original module before you proceed to the next cure.

## Apple Hardware Test

Apple Hardware Test is a diagnostic tool for detecting problems with Apple internal hardware components such as logic board, memory, modem, video RAM, and Apple AirPort Card. The test does not check externally connected hardware components such as USB or FireWire devices; it also does not check non-Apple devices such as third-party PCI cards.

**Note:** The most recent Apple Hardware Test software can be downloaded from the CD Images page on AppleCare Service Source; go to the Service Source home page and select 'Disc Images' from the quick-click table.

## Error Codes

If Apple Hardware Test detects a problem with a computer, it displays an error code, which is defined in the product's Error Code List. Consult the list for appropriate repair procedures associated with the code.

All Error Code Lists are included in the Service Diagnostics Matrix, Knowledge Base article 112125. You can also access this matrix by clicking the Service Diagnostics rollover link under any of the product areas on the Service Source home page.

## No Power

### No fan, no hard drive noise, and the screen is black.

1. Verify the power outlet is good. Plug a different device into the socket to ensure there is power, or plug computer into another outlet.
2. Check the power cord. Use a known good power cord.
3. Check connection of the power cord on both ends. Verify that the plug is securely plugged into both the A/C outlet and back of the computer.
4. Remove keyboard, mouse, and other peripherals such as speakers.
5. Disconnect the power cord, place the computer in the service stand, and remove the user access plate.
6. Reset PMU. Refer to “Resetting the PMU on the Logic Board” mentioned earlier in this chapter.
7. Using a voltmeter, check the voltage on the battery test point (see graphic below). If the reading is over 3.5 volts, go to the next step. If the reading is under 3.5 volts, replace the battery and test again.

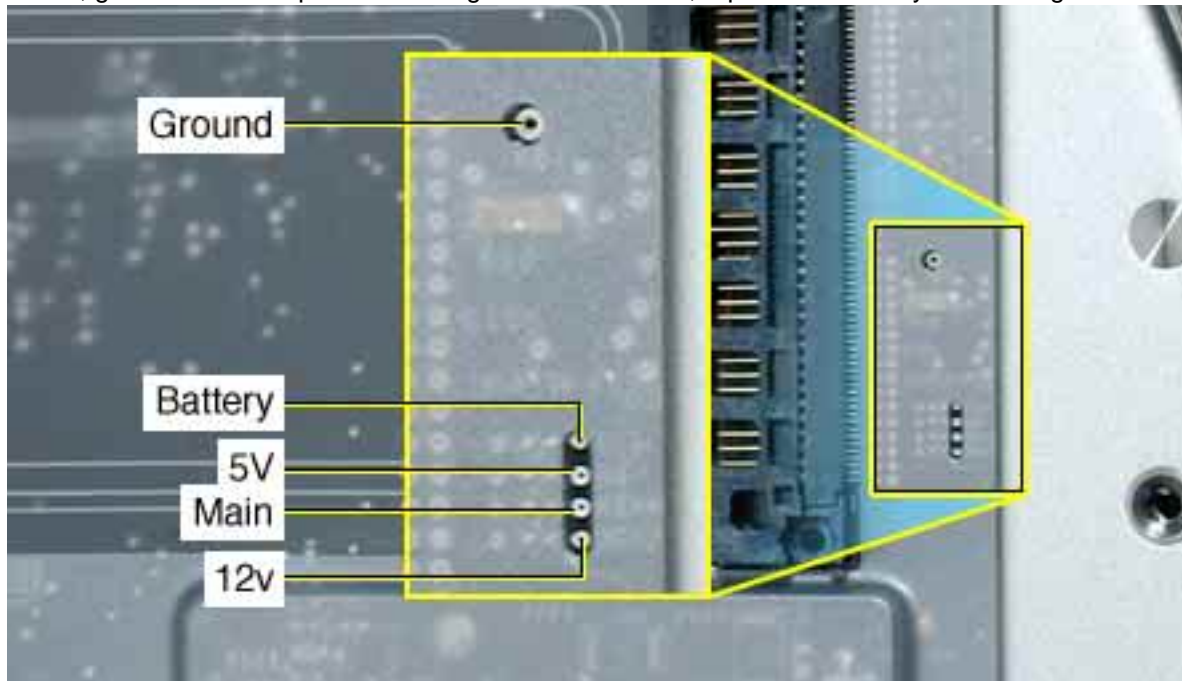

8. Plug the unit in, but do **NOT** press the power button. Using a voltmeter, check the voltage from the test point marked “Main” (see graphic above). You should get a reading of approximately 12 volts. If the reading is 12 volts, go to the next step. If you don’t get a 12 volt reading, verify that all the cables are securely connected and test the unit again. Pay special attention to the video cable.
9. Press the power switch on the computer. Using a voltmeter, check the voltage on the test point marked “12v” (see graphic above). You should get a reading of approximately 12 volts. If the reading is 12 volts, go to the next step. If you do not get a 12 volt reading, replace the main logic board.
10. Using a voltmeter, check the voltage on the test point marked “5v” (see graphic above). You should get a reading of approximately 5 volts. If the reading is 5 volts, go to the next step. If you do not get a 5 volt reading, replace the main logic board.



11. Remove the bottom housing. **Warning:** Whenever the bottom housing is opened for service, you must do two things:
  - You must clean the original thermal film from the surfaces joining the thermal interface layer and reapply thermal paste to the thermal pipe.
  - The bottom housing has four torx screws that must be tightened to at least 17 in.-lbs. If you do not have a torque driver, you will have to make sure these screws are tightened by hand **FIRMLY, BUT NOT FORCIBLY**. Or, purchase the service tool (076-0899) in order to ensure the thermal pipe is firmly mated with the top base. If the bottom housing is not securely attached to the base in this fashion, the CPU may overheat and become damaged.
12. Check the AC line filter. To measure power at the AC line filter cable, disconnect the AC line filter cable from the power supply cable. Switch your multimeter to read AC voltage. Touch the black probe to the pin of the brown wire, and touch the red probe to the pin of the blue wire (see graphic below). Do you measure 120v (line voltage)? If yes, reconnect the AC line filter and go on to the next step. If no, replace the AC Line Filter.

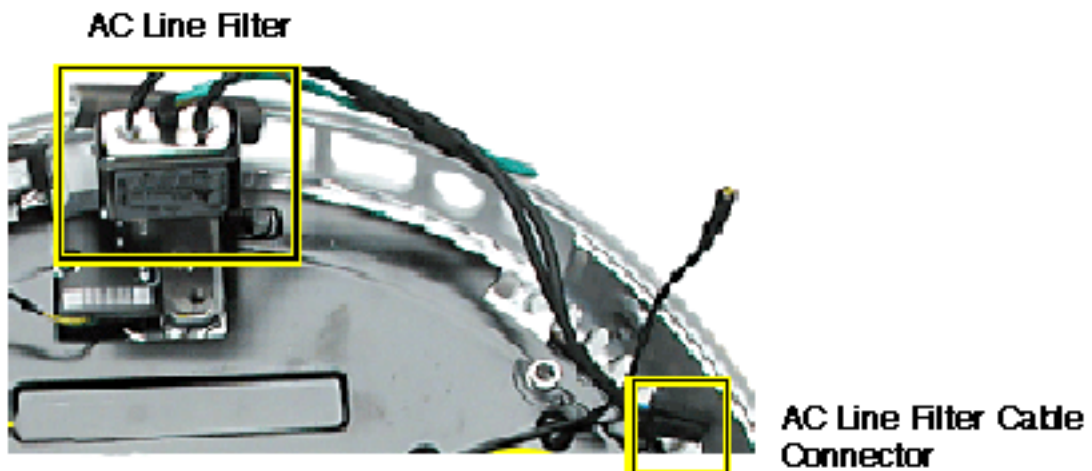

13. Connect the diagnostic cables (part 076-0897) between the upper housing components and the logic board. Refer to “Service Cables” mentioned earlier in this chapter.
14. Check the connection of the video cable on the LCD flat panel, and try to power on the unit again. If you still have no power, go on to the next step.

- 
15. Check power supply output. Disconnect the diagnostic power cable from the power supply connector, and measure power at the power supply connector by touching the black probe to the ground pin, and using the red probe to measure power at the pins indicated in the graphic below. Did you measure +12v at each point? If yes, replace the logic board. If no, replace the power supply.

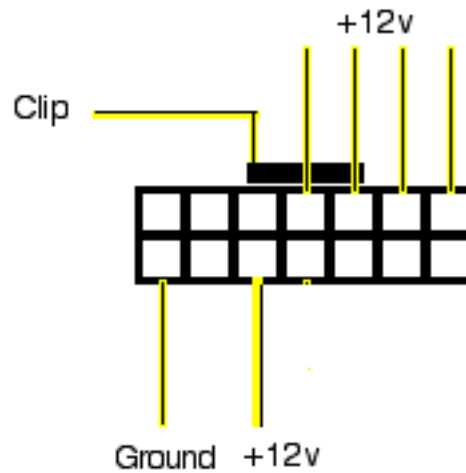

16. Replace the inverter board.  
17. Replace the neck assembly.

## No Video

**Screen is dark, fan is running and the hard drive is spinning. You may hear the startup chime as well.**

1. Reset parameter RAM. Press Command-Option-P-R during startup before “Welcome to Macintosh” appears.
2. The system software could be damaged. Start up from the system CD that came with the computer.
3. Remove the user access panel. With the unit powered on, check if a red LED (shown below) is visible in the access door. If the red LED is on, power is on. If you don't see the LED glowing red, follow the steps under the symptom “No Power”.

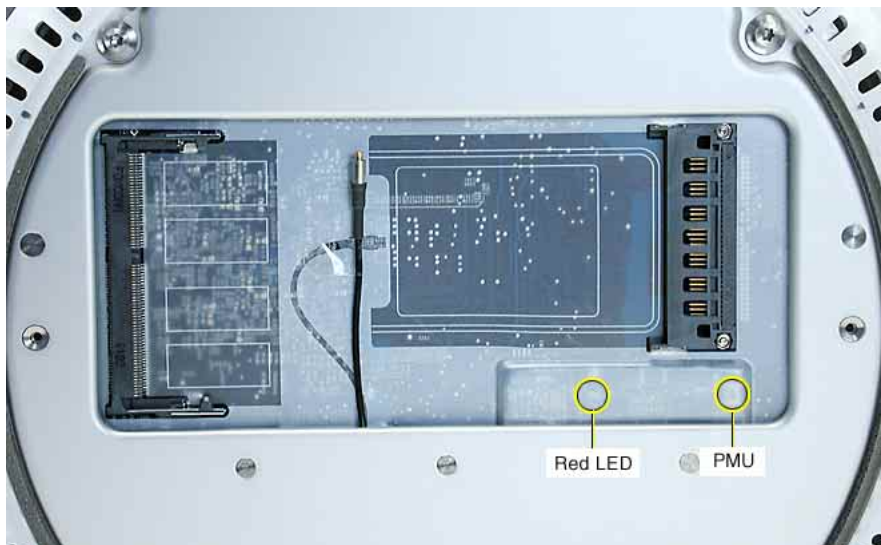

4. Disconnect the A/C power cord. Place the unit in the service stand and remove the user access plate. Press the PMU reset button on the logic board. Refer to “Resetting the PMU on the Logic Board” mentioned earlier in this chapter.
5. Check for external video. Connect an external monitor to the mini-VGA port. If you don't have external video, replace the main logic board. If you do have external video, go on to the next step.
6. Open the bottom housing and verify that all the cables are securely attached. Pay special attention to the video cable (located near the modem). If the cables are securely attached, go on to the next step.  
**Warning:** Whenever the bottom housing is opened for service, you must do two things:
  - You must clean the original thermal film from the surfaces joining the thermal interface layer and reapply thermal paste to the thermal pipe.
  - The bottom housing has four torx screws that must be tightened to at least 17 in.-lbs. If you do not have a torque driver, you will have to make sure these screws are tightened by hand **FIRMLY, BUT NOT FORCIBLY**. Or, purchase the service tool (076-0899) in order to ensure the thermal pipe is firmly mated with the top base. If the bottom housing is not securely attached to the base in this fashion, the CPU may overheat and become damaged.
7. Check the connection of the video cable to the LCD flat panel display (under copper tape).

- 
8. Replace the inverter board.
  9. Replace the LCD display. **Important:** If you are replacing the display, be sure to install the new display shield and EMI gaskets that come with the new LCD panel. Installation instructions are included with the new display panel. Additional display shields/gasket kits are also available separately as a kit, part #076-0958.
  10. Replace the neck assembly
  11. Replace the logic board.
  12. Replace the power supply board.

---

## Display

### Screen tilts to the left or the right even after a manual adjustment.

**Note:** It is normal for the screen on an iMac (Flat Panel) to have a small amount of horizontal play. However, the screen should be able to be adjusted so that it will stay in a level horizontal position.

1. Remove ten screws connecting the back cover to the flat panel LCD display (refer to the Take Apart chapter, display topic).
2. Disconnect the panel cables to gain access the three screws on the metal cable retainer shown below. Remove the screws and lift the cable retainer off the panel shield.



3. Loosen the four screws (shown below) that hold the panel shield to the neck assembly, and tilt the screen the opposite direction of the tilt.



4. While holding the display bezel in this position, tighten the same four screws that hold the panel shield to the neck assembly.
5. Replace the panel and check that the display is now horizontally level. **Important:** If you are replacing the display, be sure to install the new display shield and EMI gaskets that come with the new LCD panel. Installation instructions are included with the new display panel. Additional display shields/gasket kits are also available separately as a kit, part #076-0958.

---

## Hard Drive

### Hard Drive won't mount to the desktop

1. Disconnect any connected peripherals.
2. Boot from the system CD that came with the computer and see if the hard drive mounts on the desktop.
3. Launch Drive Setup and update the hard drive driver.
4. If no hard drive is found in Drive Setup, verify the hard drive cable connections.
5. Replace the hard drive cable.
6. Replace the hard drive.
7. Replace the logic board.

### Flashing question mark appears on the screen

1. Boot from the system CD that came with the computer and see if the hard drive mounts on the desktop.
2. Launch Drive Setup and update the hard drive driver.
3. If no hard drive is found in Drive Setup, verify the hard drive cable connections.
4. Replace the hard drive cable.
5. Reinstall the software drivers for the hard drive.
6. Reinstall system software. Backup the data first.
7. Reinitiation the hard drive.
8. Replace the hard drive.
9. Replace the logic board.

### System hangs during normal startup process

1. Boot from the system CD that came with the computer and see if the hard drive mounts on the desktop.
2. Using Drive Setup, reinstall the system software drivers for the hard drive.
3. Using Drive Setup, reinitiation the hard drive.
4. Check all cable connections to and from the hard drive.
5. Replace the hard drive cable.
6. Replace the hard drive.
7. Replace the logic board.

---

## Optical Drive

### Optical drive won't mount to the desktop

1. Try cleaning the disc. If it is dirty or scratched, it may not mount.
2. Try a different disc.
3. Boot from Apple Hardware Test (hold down the "C" key at startup) or boot from the system install CD (use Startup Manager, hold down the Option key at startup).
4. Perform a clean install with the CD that came with the computer.
5. Replace the optical drive cable.
6. Replace the optical drive.
7. Replace the logic board.

### Can't boot from the optical drive

1. Try cleaning the disc. If it is dirty or scratched, it may not mount.
2. Try a different disc.
3. Boot from Apple Hardware Test (hold down the "C" key at startup) or boot from the system install CD (use Startup Manager, hold down the Option key at startup).
4. Perform a clean install with the CD that came with the computer.
5. Replace the optical drive cable.
6. Replace the optical drive.
7. Replace the logic board.

### Optical disc constantly ejects

1. Disconnect all peripheral devices, especially the mouse in cases where the disc is constantly ejecting.
2. Try cleaning the disc. If it is dirty or scratched, it may not mount.
3. Try a different disc.
4. Boot from Apple Hardware Test (hold down the "C" key at startup) or boot from the system install CD (use Startup Manager, hold down the Option key at startup).
5. Perform a clean install with the CD that came with the computer.
6. Replace the optical drive cable.
7. Replace the optical drive.
8. Replace the logic board.



---

## Sound Out

### No sound from either internal or external speakers

1. Verify volume setting is correct in system preferences.
2. Replace the external speakers or headphone in question with a known-good device.
3. Reset parameter RAM. Press Command-Option-P-R during startup before “Welcome to Macintosh” appears.
4. Verify internal speaker cable is connected.
5. Replace the internal speaker.
6. Replace the logic board.

---

## Sound In

### No sound is recorded

1. Check setup of the system preferences for the microphone.
2. Check the microphone cable connection.
3. Replace the internal microphone.
4. Replace the neck assembly.

---

## **Error Beep(s)**

### **Computer beeps at startup.**

1. RAM expansion DIMMs for the iMac must be PC133 compliant and use SDRAM devices. If the user installs a DIMM that uses EDO or SGRAM devices, the computer will beep several times when the user attempts to restart the computer.
2. Refer to "Power-On Self Test" mentioned earlier in this chapter.

---

## Modem

### No modem dial tone

1. Verify known-good analog (not digital) telephone line.
2. Verify known-good RJ-11 telephone cable.
3. Verify RJ-11 cable is not plugged into Ethernet port.
4. Inspect RJ-11 connector and modem port for pin damage.
5. Verify RJ-11 cable is firmly installed in the modem port.
6. Verify correct modem driver is installed and the correct CCL is selected. If the problem persists, reinstall system software.
7. Open the bottom housing. Verify the internal RJ-11 modem cable is connected to the modem.
8. Replace the RJ-11 board.
9. Replace the modem.
10. Replace the logic board.

## I/O Ports

### Difficulty Plugging in an Ethernet Cable

**Note:** The Ethernet port on an iMac (Flat Panel) has a special mechanism to prevent modem cables from accidentally being inserted. In some cases, this mechanism can cause difficulty when attempting to plug in an Ethernet cable.

1. Verify that you are plugging into the Ethernet port. See graphic below.

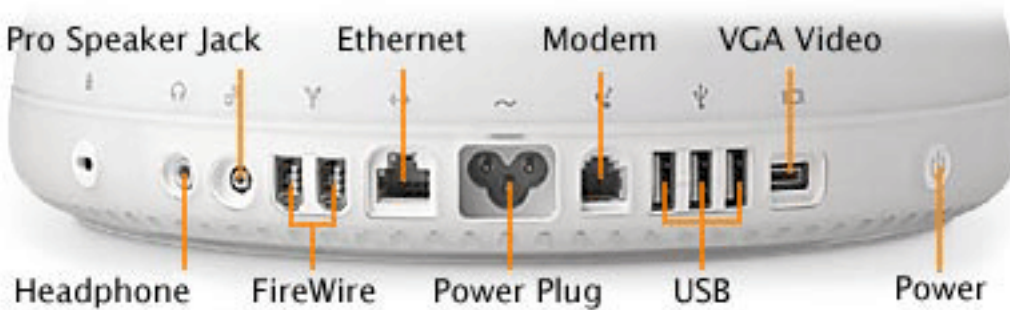

2. Notice that the port has two metal tabs (circled below) which prohibit the use of a modem cable.



3. When inserting the Ethernet cable, try holding the cable at a slight angle and wiggle the connector to get past the metal tabs.
4. Once the connector has passed the metal tabs it should slide in with no further difficulty.

---

## USB Printing Problems

### **iMac cannot print to attached known-good printer.**

1. Verify that the printer is Macintosh compatible.
2. Verify that you have setup the printer correctly in OS X.
3. Reinstall the printer driver.
4. Switch the printer to another USB port.
5. Replace the printer interface cable.
6. System software is corrupted. Reinstall the system software.
7. Replace the logic board.

## Procedure

1. Slightly peel back the edge of the EMI shield and copper shielding as shown (step 1 below). Remove the inverter shield from the inverter (step 2 below).

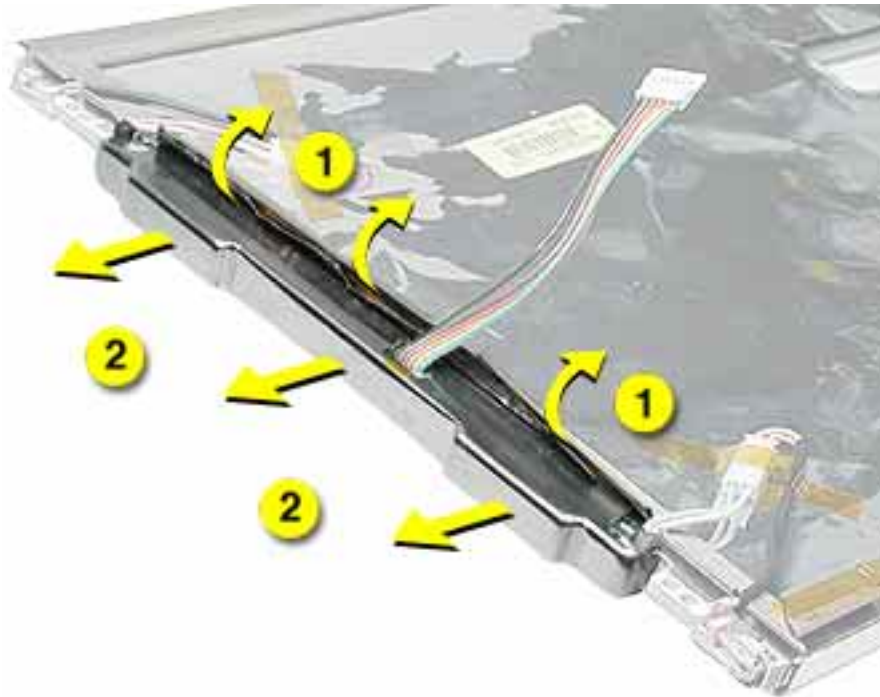

2. Remove tape and disconnect the two inverter cables (step 3 below). Pull the inverter off the edge of the display panel (step 4 below).

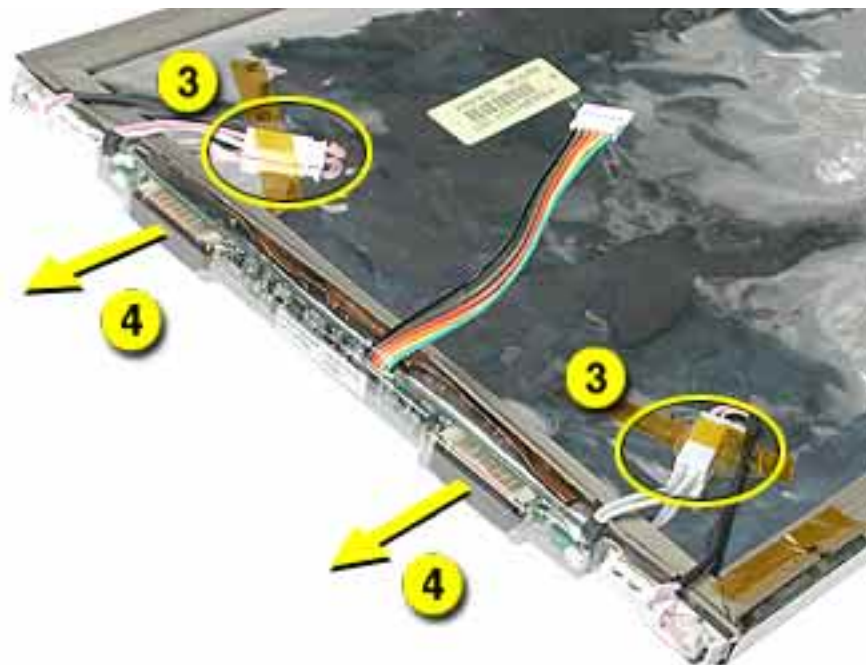



Upgrades  
iMac (17-inch Flat Panel)





# Memory, SO-DIMM

## Tools

- Phillips #0 screwdriver.

## Part Location



The iMac has two RAM expansion slots. The factory-installed RAM slot accepts a standard PC133 168-pin DIMM (up to 512 MB in capacity) and is accessible only by an Apple Authorized Service Provider. The user-accessible slot (shown above) accepts a standard PC133 144-pin SO-DIMM and is normally used for added RAM. Only the SO-DIMM slot is accessible by the user. A SO-DIMM for the iMac computer can contain either 64, 128, 256, or 512 MB of memory.

**Note:** This procedure describes installing a SO-DIMM memory module in the user-accessible slot.

---

## Procedure

### Opening the Computer

**Warning:** The computer must be turned off before RAM modules are removed or inserted. To remind you, a red LED is visible in the access door. If the red LED is on, power is on, and must be turned off before changing RAM modules.

1. Shut down the computer.
2. Unplug all cables from the computer except the power cord.
3. Lay the computer down on a soft cloth.



4. Loosen the four captive screws at the base of the computer and gently remove the access panel.



---

**Important:** To avoid electrostatic discharge, always ground yourself by touching metal before you touch any parts or install any components inside the computer. To avoid static electricity building back up in your body, do not walk around the room until you have completed the installation and closed the computer.

5. Touch a metal surface inside the computer.



6. Unplug the power cord.

## Installing the Memory Module

**Note:** If you are replacing a defective memory module, rather than adding a module, remove the defective module before proceeding.

1. Line up the notch on the memory module with the notch (circled below) on the memory slot.

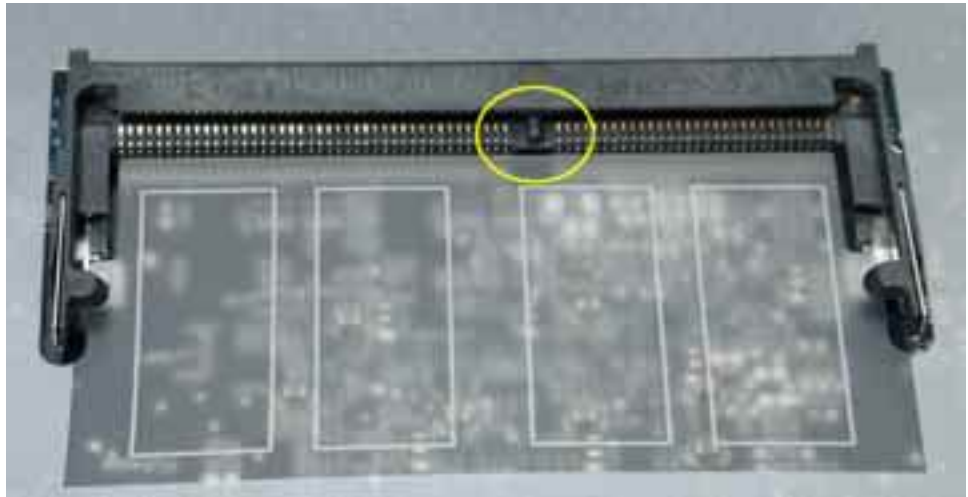

2. **Important:** Do not push the clips (circled below) when inserting memory. They are used to remove memory from the slot, not when inserting memory. These clips are fragile and can break.

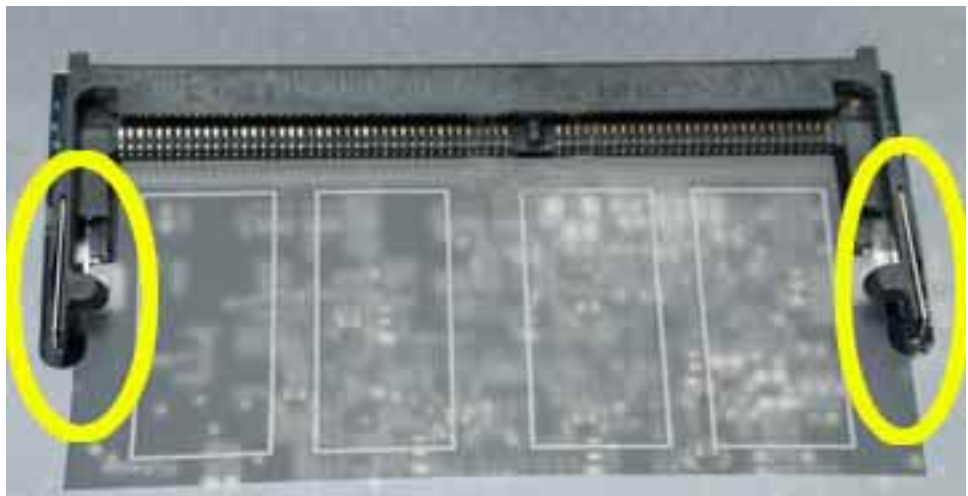

3. Gently insert the memory module into the slot. You will hear a click when the memory is completely inserted into the slot. **Note:** Make certain to push the memory module in the direction of the arrows.



4. Press down gently on the memory until you hear it click into place under the two locking tabs (circled below) on the sides of the slot.



---

## Closing the Computer

1. Replace the access panel and the four screws.

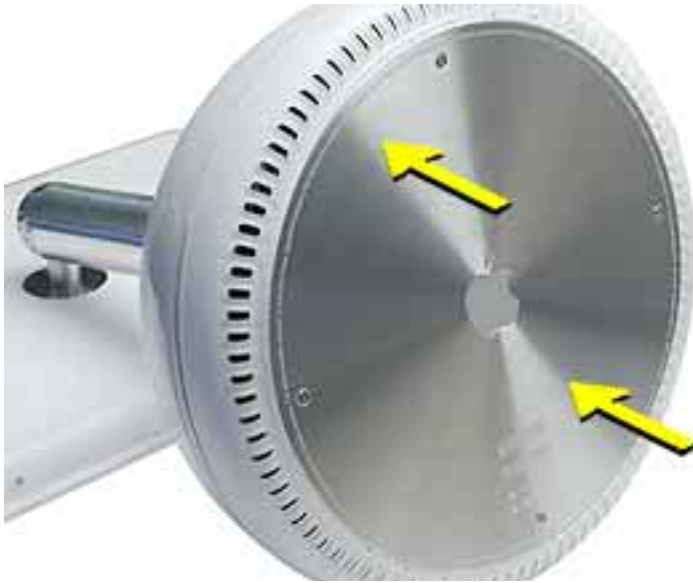

2. Reconnect all cables and restart the computer.

**Warning: Never turn on the computer unless all of its internal and external parts are in place and it is closed. Operating the computer when it is open or missing parts can damage your computer or cause injury.**



# AirPort Card

## Tools

- Phillips #0 screwdriver to remove the user access panel.

## Part Location



**Note:** Written and video instructions covering customer-insatiable parts are available at <http://www.info.apple.com/installparts/>.



---

## Opening the Computer

**Warning: Always shut down your computer before opening it to avoid damaging its internal components or causing injury. Shut down the computer and wait five minutes before continuing.**

1. Unplug all cables from the computer except the power cord.
2. Lay the computer down on a soft cloth.



3. Loosen the four captive screws at the base of the computer and gently remove the access panel.

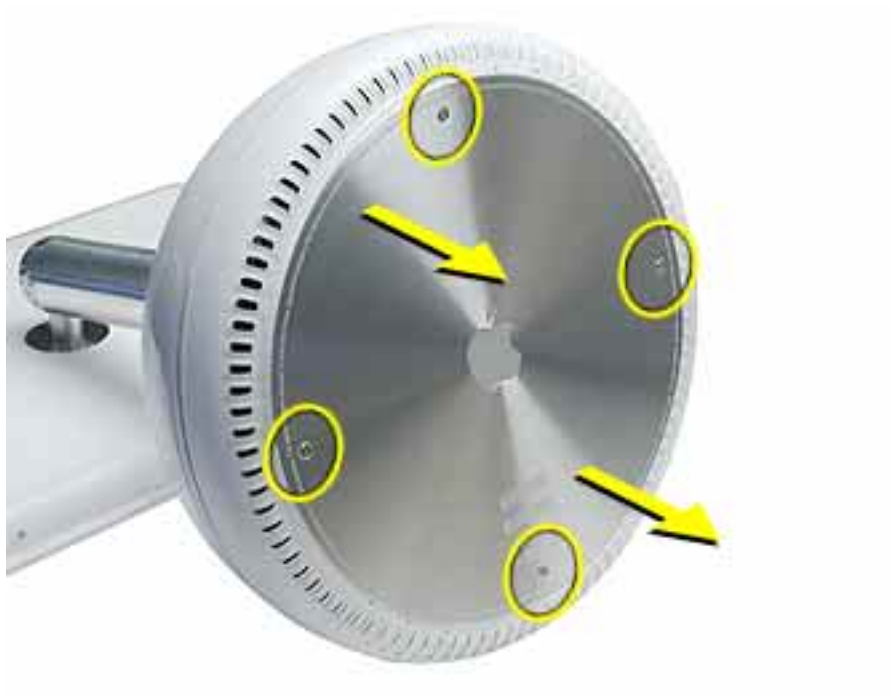

---

**Important:** To avoid electrostatic discharge, always ground yourself by touching metal before you touch any parts or install any components inside the computer. To avoid static electricity building back up in your body, do not walk around the room until you have completed the installation and closed the computer.

4. Touch a metal surface inside the computer.



5. Unplug the power cord.

## Installing the AirPort Card

**Note:** If you are replacing a defective AirPort Card, rather than adding a card, remove the defective card before proceeding.

1. Connect the AirPort antenna firmly to the AirPort Card.



2. Insert the card into the AirPort Card slot.



## Closing the Computer

1. Replace the access panel and tighten the four captive screws.



2. Reconnect all cables and restart the computer.

**Warning: Never turn on the computer unless all of its internal and external parts are in place and it is closed. Operating the computer when it is open or missing parts can damage your computer or cause injury.**

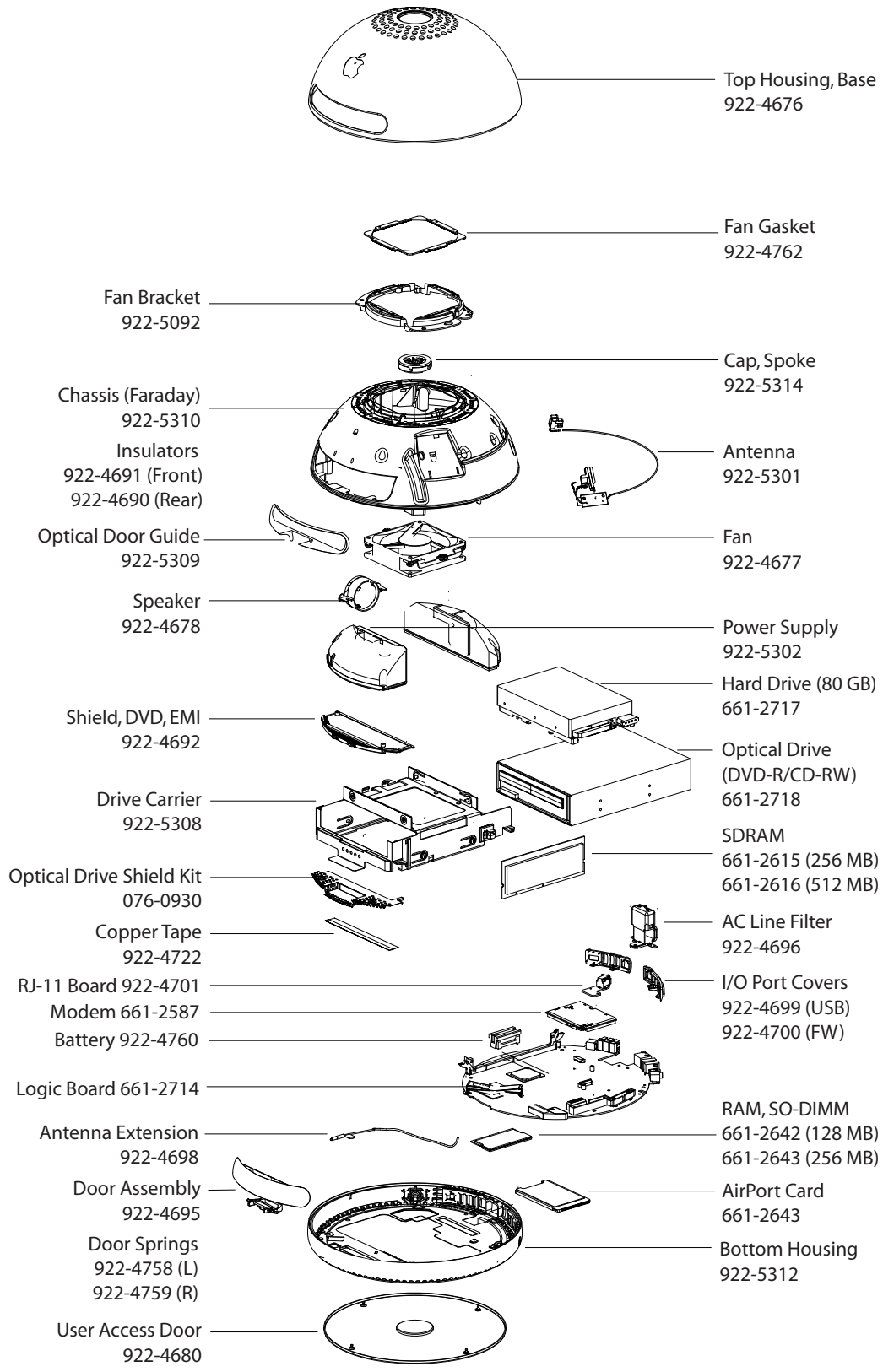

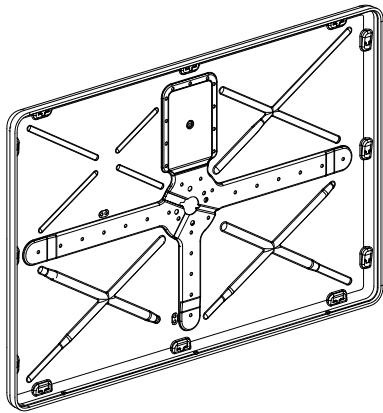

Housing, Rear Display  
(Back Cover and Shield)  
922-5299



Deflector, Wire, Display  
922-5300

17" LCD Display  
661-2715

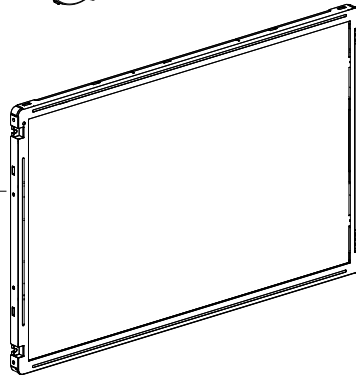

Inverter Assembly  
922-5298

Bezel, Display  
922-5297

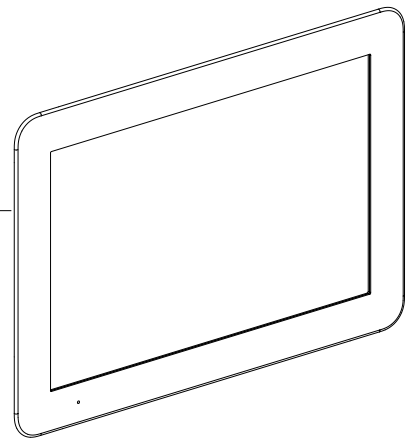

Neck Extension  
(for 17" Display)  
661-2716

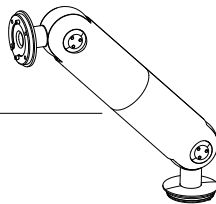

# iMac (17-inch Flat Panel) Screw Locator - 1 of 7

Bottom Housing Bolts (4)  
T-15, 922-5104

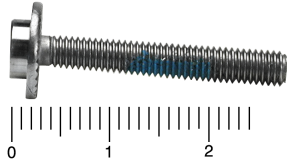

Grounding Screw to Faraday (1)  
T-15, 922-4714

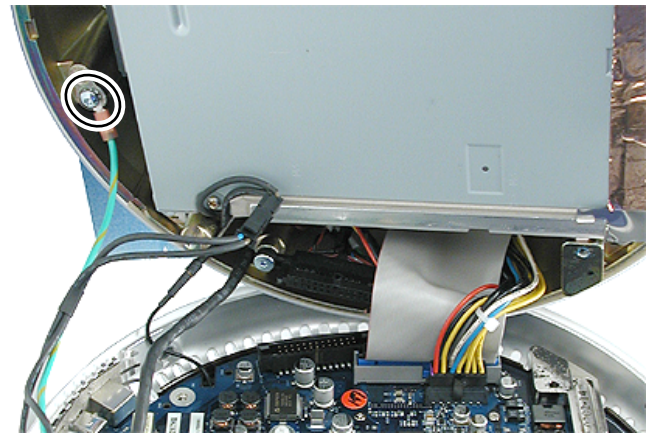
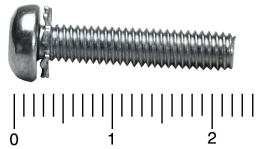

Drive Carrier to Faraday (4)  
T-10, 922-4709

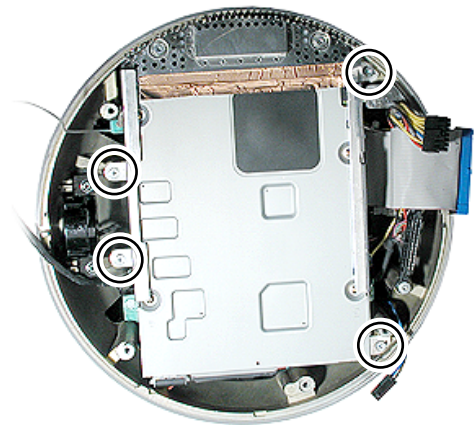
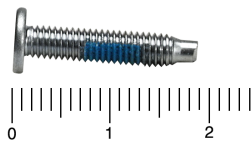

Power Supply (4)  
T-10, 922-4709

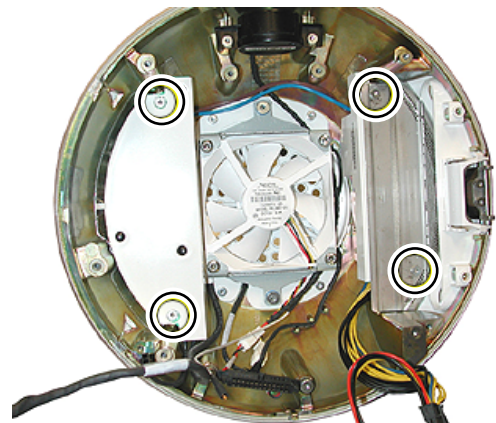
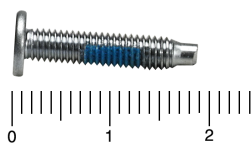

# iMac (17-inch Flat Panel) Screw Locator - 2 of 7

Speaker (2)  
T-10, 922-4709

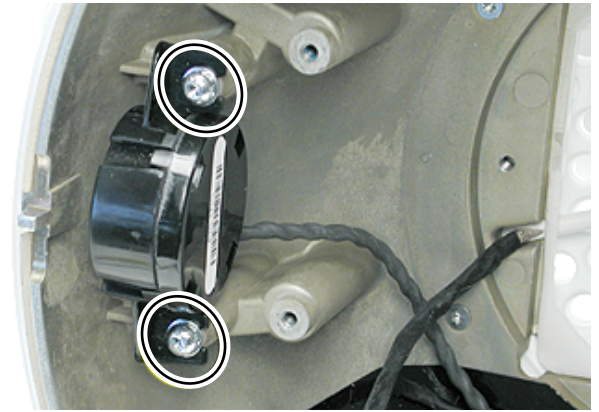
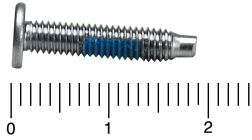

Hard Drive to Carrier to Assy (4)  
T-10, 922-5105

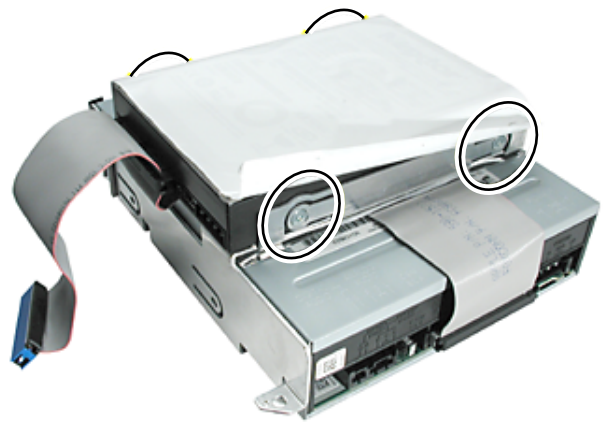
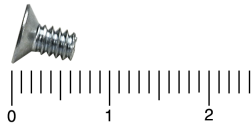

Optical Drive to Carrier Assy (4)  
T-10, 922-5107

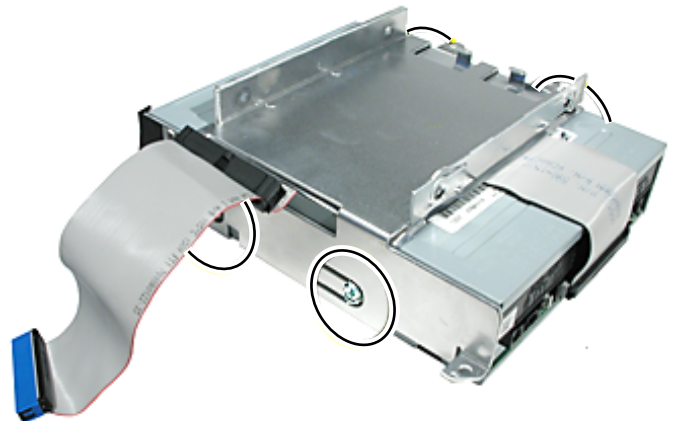
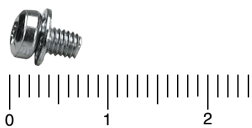

Power Supply Shield (2)  
T-10, 922-4707

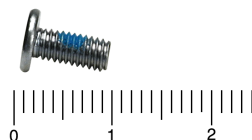



# iMac (17-inch Flat Panel) Screw Locator - 3 of 7

---

Metal DVD Shield (2)  
T-10, 922-4707

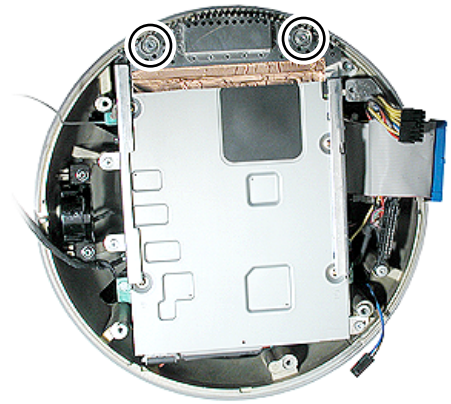
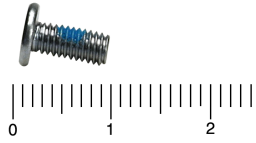

Fan (2)  
T-15, 922-4710

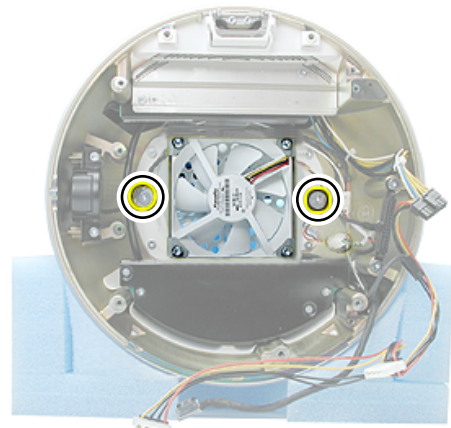
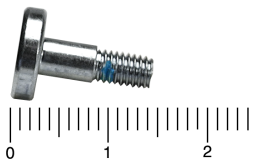

Door Hinge (2)  
T-10, 922-5108

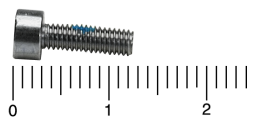

# iMac (17-inch Flat Panel) Screw Locator - 4 of 7

Blind Mate Connector (2)  
T-10, 922-5109

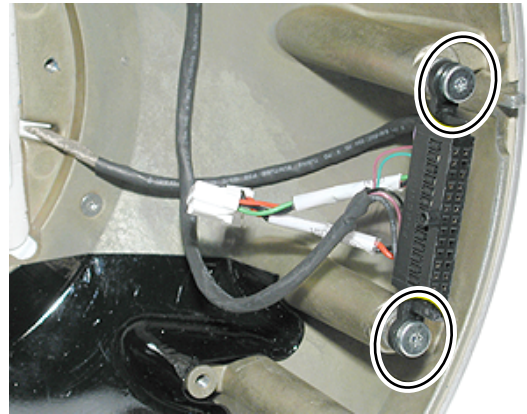
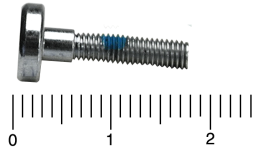

Faraday to Outer Shell (2)  
T-10, 922-5106

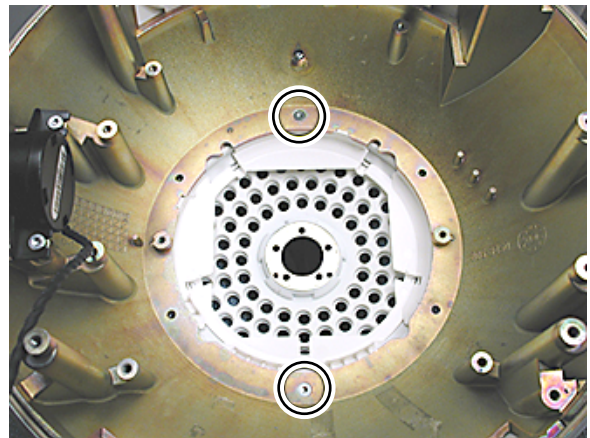
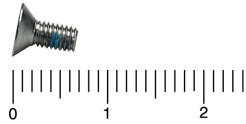

Faraday Under Logo (1)  
T-8, 922-4706

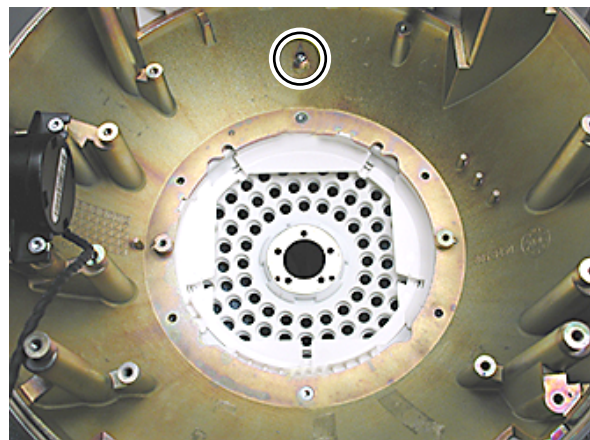
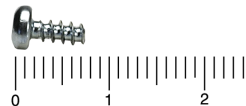

White Plastic Cap  
2 Black  
T-10, 922-5110

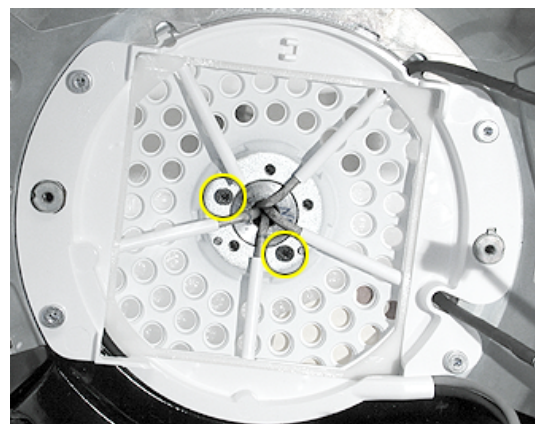
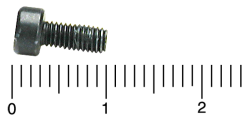

# iMac (17-inch Flat Panel) Screw Locator - 5 of 7

White Plastic Cap  
3 Silver  
T-10, 922-5111

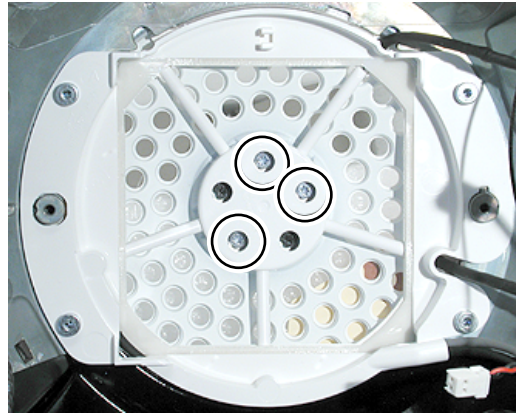
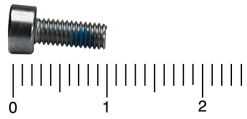

White, Plastic Neck  
Cable Retainer (4)  
T-10, 922-5112

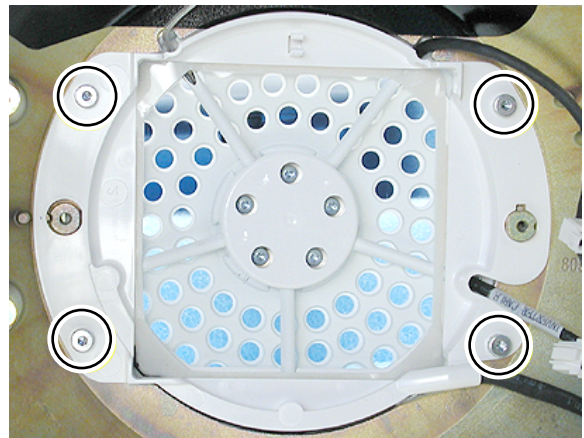
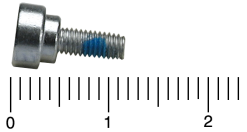

LCD Bezel (3)  
1.5mm hex, 922-5336



Antenna to Faraday (2)  
T-10



# iMac (17-inch Flat Panel) Screw Locator - 6 of 7

Display Support to Neck Extension (4)  
T-10, 922-5332

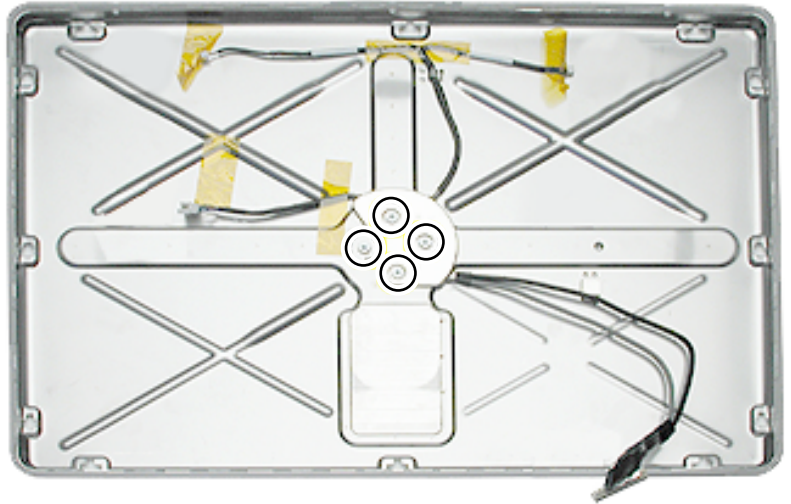

Logic Board,  
Metal (3)  
Nylon (1)  
T-15

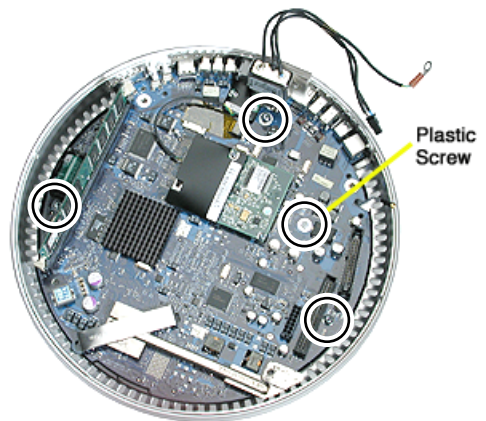
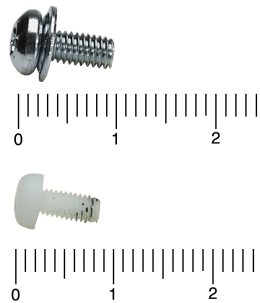

RJ-11 Board (2)  
T-6 922-5115

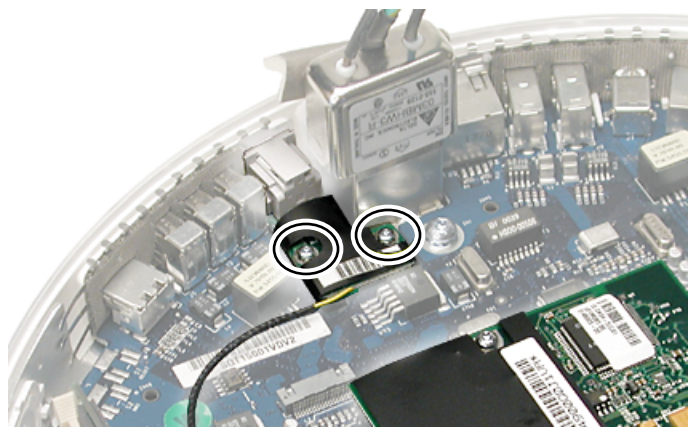
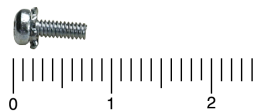

# iMac (17-inch Flat Panel) Screw Locator - 7 of 7

---

Modem (2)  
T-8 922-5116



Antenna Extension (2)  
T-10

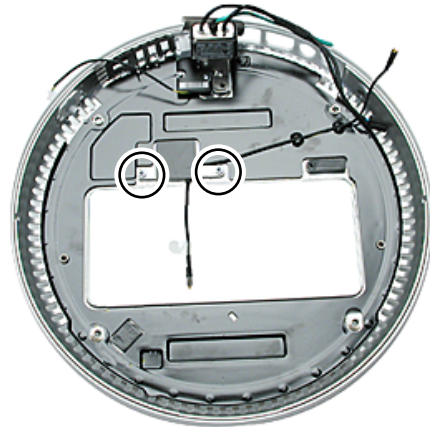
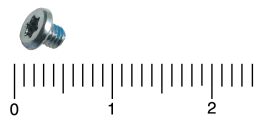

AC Line Filter (2)  
T-10 922-5330

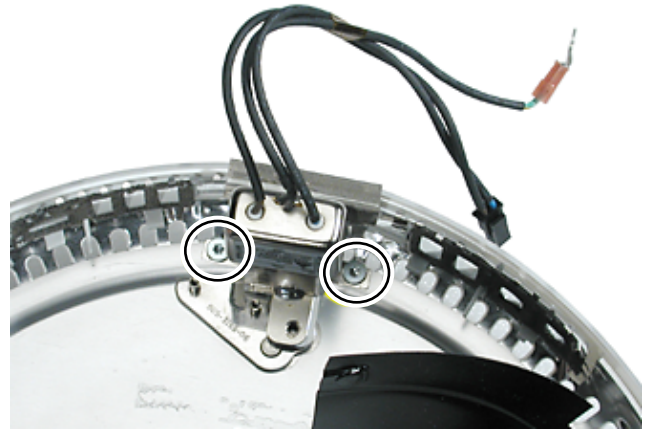
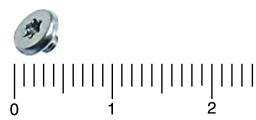

# iMac (17-inch Flat Panel) Screw Matrix In Centimeters

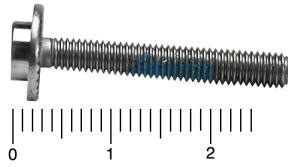

Bottom Housing Bolts  
(4)  
T-15 922-5104

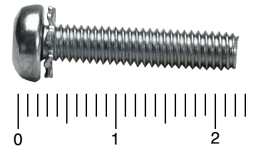

Grounding Screw to Faraday  
(1)  
T-15 922-4714

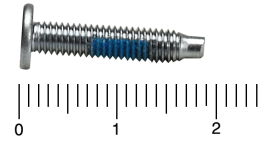

Speaker (2)  
Power Supply (4)  
Drive Carrier to Faraday (4)  
T-10 922-4709



Hard Drive to Carrier to Assy  
(4)  
T-10 922-5105

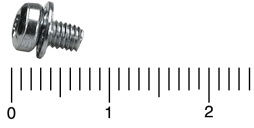

Optical Drive to Carrier Assy  
(4)  
T-10 922-5107

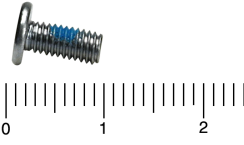

Power Supply Shield (2)  
Metal DVD Shield (2)  
T-10 922-4707

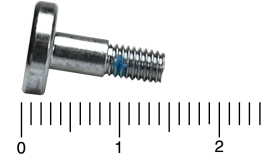

Fan  
(2)  
T-15 922-4710

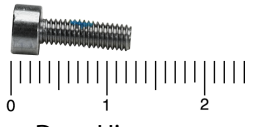

Door Hinge  
(2)  
T-10 922-5108

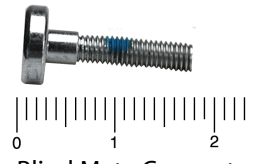

Blind Mate Connector  
(2)  
T-10 922-5109

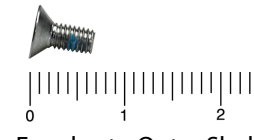

Faraday to Outer Shell  
(2)  
T-10 922-5106

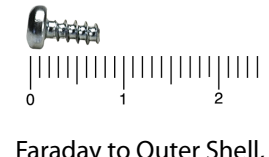

Faraday to Outer Shell,  
Under the Logo (1)  
T-8 922-4706

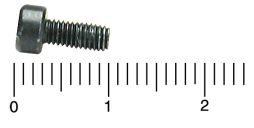

Extension to Vent Cap  
2 Black  
T-10 922-5110

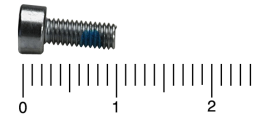

Extension to Vent Cap  
3 Silver  
T-10 922-5111

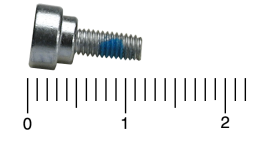

Fan Bracket Retainer (white)  
(4)  
T-10 922-5112



Display Support to Neck  
(4)  
T-10 922-5332

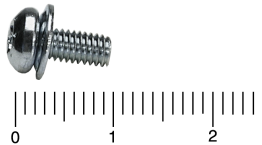

Logic Board, Metal (3)  
T-15 922-4715



Logic Board, Nylon (1)  
Phillips 0 922-5113

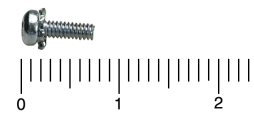

RJ-11 Board (2)  
T-6 922-5115



Modem (2)  
T-8 922-5116



AC Line Filter  
(2)  
T-10 922-5330



Antenna (2)  
T-10



Display to Frame (4)  
T-10 922-5331



Display to Bezel (3)  
1.5 mm hex 922-5336

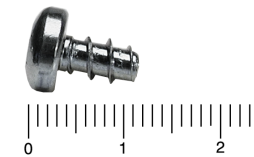

Fan Bracket to Fan (2)  
T-25 922-4708