



MacBook (13-inch, Late 2009)

MacBook (13-inch, Late 2009)
MacBook (13-inch, Mid 2010)

Updated 2010-10-22

 Apple Inc.

© 2009 Apple Inc. All rights reserved.

Under the copyright laws, this document may not be copied, in whole or in part, without the written consent of Apple.

Every effort has been made to ensure that the information in this document is accurate. Apple is not responsible for printing or clerical errors.

Apple
1 Infinite Loop
Cupertino, CA 95014-2084
USA
+ 1 408 996 1010
www.apple.com

Apple, the Apple logo, Mac, MacBook, and Macintosh are trademarks of Apple Inc., registered in the U.S. and other countries.

MacBook (13-inch, Late 2009)

Contents

Updates 7

- Updated 22 October 2010 7
- Updated 15 June 2010 7
- Updated 18 May 2010 7
- Updated 09 April 2010 8
- Updated 01 April 2010 8
- Updated 18 February 2010 8
- Updated 15 January 2010 9
- Updated 8 January 2010 9
- Updated 2 December 2009 9
- Updated 5 November 2009 9
- Updated 27 October 2009 10
- Apple Technician Guide introduced 20 October 2009 10

Feedback 10

Basics

Overview 12

- Safety: Battery Precautions 13

Serial Number Location 14

- Transferring the Serial Number 15
- Note About Images In This Guide 15
- Caution About Ordering Replacement Parts 15

Troubleshooting

General Troubleshooting 17

- Update System Software 17
- Troubleshooting Theory 17
- Hardware vs. Software 17
- MacBook (13-inch, Late 2009): Functional Overview 18
- MacBook (13-inch, Mid 2010): Functional Overview 19
- MacBook (13-inch, Late 2009): Block Diagram 20
- MacBook (13-inch, Mid 2010): Block Diagram 21
- Liquid Contact Indicators 22
- Common Reset Procedures 23
- Apple Service Diagnostics 24

Clamshell Service Diagnostic Read Me 25
Display Issue: Pixel Anomalies 25

Symptom Charts 27

Startup and Power Issues 27

No Power 27

Intermittent Shutdown 34

No Video/Bad Video 39

Battery Isn't Recognized or Won't Charge 42

Kernel Panic/System Crashes 44

Battery Run Time Too Short 46

Won't Run on Power Adapter 47

Noise / Hum / Vibration 48

Battery Leaking or Swollen 51

Uncategorized Symptom 51

Communications 52

Ethernet Port/Device Issue 52

AirPort/Bluetooth: Defective Wireless Devices 54

No/Poor Wireless Signal 56

Wireless Input Device Loses Connection 57

Wireless Performance Issue / Slow Connection 60

Wireless Input Device Doesn't Pair 62

Uncategorized Symptom 64

Display 65

Display Anomalies 65

Defective Camera / Built-in iSight Not Operating Correctly 70

Blank / No Video 71

Backlight Issue / No Backlight 72

Noise / Unstable Flickering 74

Mechanical/Physical Damage 75

Cosmetic Defects 75

Uncategorized Symptom 76

Mass Storage 77

Hard Drive Read/Write Issue 77

Hard Drive Not Recognized/Not Mounting 78

Hard Drive Noisy 80

Optical Drive Won't Accept/Reject Media 81

Optical Drive Not Recognized/Device Not Mounting 85

Optical Drive Noisy 86

Optical Drive Not Performing to Specs 88

Uncategorized Symptom 89

Input/Output Devices 90

USB Port Does Not Recognize Known Input Devices 90

Built-in Keyboard Does Not Work Properly 91

Specific Keys Don't Work 92

Built-in Keyboard Is Not Recognized 92

Built-in Trackpad Does Not Track Properly	94
Built-in Trackpad Does Not Work	95
Built-in Speaker Has No Audio	97
Distorted Sound from Internal Speaker	98
Uncategorized Symptom	100
Mechanical Issues: Thermals and Enclosure	101
Reset/Power Button Stuck	101
System Runs Hot	102
Uncategorized Symptom	104

Take Apart

General Information 106

Connector Types on Logic Board	106
Tools	109
Icon Legend	110
Temperature Concerns	111
Replacement Steps	111
Note About Images In This Guide	111
Screw Sizes	111

Bottom Case 112

Top Case Snaps 117

Battery 119

Removal	120
Replacement	121

Trackpad 123

Removal	124
Replacement	125

Hard Drive Bracket 128

Hard Drive 130

Removal	131
Replacement	133

Hard Drive Connector Cable 135

Hard Drive Grommets 136

Memory 138

Removal	139
Replacement	140

Fan 142

AirPort/Bluetooth Flex Cable 145

Rear Vent 147

Rear Speaker	150
AirPort/Bluetooth Card	154
Optical Drive	156
Optical Drive Flex Cable	160
Logic Board	162
Removal	163
Replacement	165
Heatsink	171
Removal	172
Replacement	174
MagSafe Board	175
Removal	176
Replacement	177
Display Module	178
Removal	179
Replacement	183
Top Case with Keyboard	186

Additional Procedures

Trackpad Grounding Strap	189
---------------------------------	------------

Views

Exploded Views 192

Display View	192
MacBook (13-inch, Late 2009): Main View (side-by-side serial numbers)	193
MacBook (13-inch, Late 2009): Main View (stacked serial numbers)	194
MacBook (13-inch, Mid 2010): Main View (stacked serial numbers)	195

External Views 196

Front View	196
Rear View	197
Port View	197

Screw Locations 198

Bottom Case	198
Battery, Rear Vent, Hard Drive Connector Cable	199
Logic Board, Optical Drive, Speaker, Fan, MagSafe Board, Display	200
AirPort/Bluetooth Card and Heatsink	201
Top Case and Trackpad	202



Updates

Updated 22 October 2010

Troubleshooting:

- General Troubleshooting: Apple Service Diagnostics: Updated reference to diagnostic software
- General Troubleshooting: Display Issue: Pixel Anomalies Updated step 1 reference to diagnostic software
- Symptom Charts: Startup and Power Issues: Won't Start Up: Revised Quick Check to add symptom "Gray screen at startup" that is related to disconnected trackpad; added new step 2 to Deep Dive
- Symptom Charts: Startup and Power Issues: No Video/Bad Video: Revised Quick Check to add symptom "Gray screen at startup" that is related to disconnected trackpad; ; added new step 3 to Deep Dive; scaled size of fuse image in step 10 of Deep Dive
- Symptom Charts: Display: Blank/No Video: Revised Quick Check to add symptom "Gray screen at startup" that is related to disconnected trackpad; added new step 2 to Deep Dive
- Symptom Charts: Display: Backlight Issue/No Backlight: Scaled size of fuse image in step 6 of Deep Dive

Updated 15 June 2010

Troubleshooting:

- General Troubleshooting: Resetting the System Management Controller (SMC): Updated text to clarify MagSafe LED behavior; deleted text requiring resetting date and time.

Updated 18 May 2010

Basics

- Overview: Added new model: MacBook (13-inch, Mid 2010)

Troubleshooting:

- General Information: Tools: Updated Apple Service Diagnostic to 3S136 and Apple Hardware Test version to 3A181 MacBook (13-inch, Late 2009) and to 3A199 for MacBook (13-inch, Mid 2010)
- Functional Overview: Added version for MacBook (13-inch, Mid 2010)
- Block Diagram: Added version for MacBook (13-inch, Mid 2010)
- Symptom Charts: Startup/Power Issues: No Power deep dive table: Added power-on pads for MacBook (13-inch, Mid 2010) logic board

Take Apart

- Trackpad: Added alternate trackpad kit part number 922-9551



- Fan: Replaced image showing screws
- Optical Drive: Replaced 4.49 mm screw with part number 922-9516

Views:

- Exploded Views: Added Main View for MacBook (13-inch, Mid 2010)
- Screw Locations: Replaced optical drive screw part number

Updated 09 April 2010

Take Apart

- Top Case Snaps: Added new procedure showing how to replace the three top case snaps

Updated 01 April 2010

Basics

- Caution About Ordering Replacement Parts: Added reminder to enter product serial number in GSX before ordering replacement part

Troubleshooting

- Symptom Charts: Input/Output Devices: Revised trackpad steps in Deep Dive to refer to trackpad grounding strap procedure
- Symptom Charts: Input/Output Devices: Revised speaker steps in Deep Dive to address right/left speakers on top case

Take Apart:

- Battery: Added alternate part numbers for battery screws
- Trackpad: Added alternate part number for trackpad kit; corrected image for T6 set screw
- Logic Board: Added stacked serial number image; added reminder to enter product serial number in GSX before ordering replacement part
- Top Case: Added reminder to enter product serial number in GSX before ordering replacement part

Additional Procedures

- Trackpad Grounding Strap: Added new procedure to check for or install grounding strap from chassis ground to trackpad; this addresses jumpy cursor movement symptom

Views:

- Exploded Views: Added new notes about the need to refer to GSX for the most accurate parts list; added second Main View for modified part numbers
- Screw Locations: Added alternate part numbers for battery screws

Updated 18 February 2010

Take Apart:

- General Information: Connector Types on Logic Board: Added LVDS cable image and replacement caution to check for gold traces
- General Information: Tools: Added torque driver recommendation for 6 display screws
- Bottom Case: Added new Replacement step 4 to align bottom case notches to clutch



- Rear Vent: Added optional torque driver to Tools; revised step 2 screws, including new 4-mm screw with red locktite and screw ID table; added torque specifications
- Logic Board: Added optional headphone jack to Tools; added new Replacement steps 4-6 to align ports using a headphone jack
- Display Module: Added optional torque driver to Tools; revised Replacement step 1 to include torque specifications
- Top Case with Keyboard: Added replacement note about transferring the trackpad

Views:

- Screw Locations: Added torque specifications for 6 display screws

Updated 15 January 2010

Take Apart:

- Battery: Added battery label reminder

Updated 8 January 2010

Troubleshooting:

- General Information: Tools: Updated Apple Service Diagnostic to 3S135

Take Apart:

- Trackpad: Added cautions to avoid bending flexures

Updated 2 December 2009

Troubleshooting:

- General Troubleshooting: Added new section “Clamshell Service Diagnostic Read Me”
- Symptom Charts: Startup and Power Issues: Revised for Clamshell Service Diagnostic (CSD) considerations
- Symptom Charts: Communications: Revised for CSD considerations
- Symptom Charts: Display: Revised for CSD considerations

Updated 5 November 2009

Troubleshooting:

- Symptom Charts: Input/Output Devices: Built-In Trackpad Does Not Work: Revised step 2 and step 6 of Deep Dive table to check normal trackpad clicking motion

Take Apart:

- Bottom Case: Added image for screwdriver angle
- Rear Speaker: Modified image for step 4 to emphasize recessed screw
- Optical Drive: Modified image for step 1 to emphasize recessed screw
- Logic Board: Replacement: Added reminder to not remove serial number label

Views:

- Screw Locations: Added heatsink screw length



Updated 27 October 2009

Troubleshooting:

- Symptom Charts: Startup and Power Issues: No Video/Bad Video: Added backlight fuse location to step 9 of Deep Dive table; updated for separate heatsink solution
- Symptom Charts: Display: Backlight Issue/No Backlight: Added backlight fuse location to step 6 of Deep Dive table
- Symptom Charts: Mechanical Issues: Thermals and Enclosure: Updated for separate heatsink solution

Take Apart:

- General Information: Tools: Added thermal grease, cleaning wipes, T8 and #1 screwdrivers
- Trackpad: Updated steps based on trackpad kit contents
- Rear Vent: Tools: Changed from T7 to T8 screwdriver
- Optical Drive: Added image to step 2
- Heatsink: Added heatsink procedure
- Logic Board (includes Heatsink): Changed title to "Logic Board;" added heatsink replacement reminder
- MagSafe Board: Tools: Changed from #00 to T6 screwdriver

Views:

- Exploded Views: Main View: Added heatsink kit 076-1358; revised logic board reference
- Screw Locations: Added heatsink screws

Apple Technician Guide introduced 20 October 2009

Feedback

We want your feedback to help improve this and future Technician Guides!

Please email any comments to smfeedback4@apple.com

Basics

MacBook (13-inch, Late 2009)



Overview



The MacBook (13-inch, Late 2009) features a brighter LED-backlit display, a 2.26 GHz Intel Core 2 Duo processor, and the graphics performance of NVIDIA GeForce 9400M integrated graphics. Faster DDR3 memory, a larger 250 GB hard drive, and a new Mini DisplayPort round out some of the performance and feature upgrades.

The MacBook (13-inch, Mid 2010) features a 2.4 GHz Intel Core 2 Duo processor, NVIDIA GeForce 320M graphics, and a 250 GB hard drive

A longer-lasting, high performance, internal battery is no longer customer replaceable. This high-density battery can be safely removed only by an authorized Apple service provider.

For full technical specifications, refer to AppleCare Tech Specs:

<http://support.apple.com/specs/>



Safety: Battery Precautions

This computer contains an internal-only battery that is serviceable by Apple-authorized service providers only. Tamper-proof screws are employed to prevent customers from attempting to remove it.

WARNING: Every time you remove the bottom case, disconnect the battery cable from the logic board.



WARNING: Because the battery is internal and connected to the logic board by a cable, it **MUST BE DISCONNECTED** before performing service procedures. If you fail to do so, live current from the battery will short circuit the components and render the logic board and/or LVDS cable unusable.

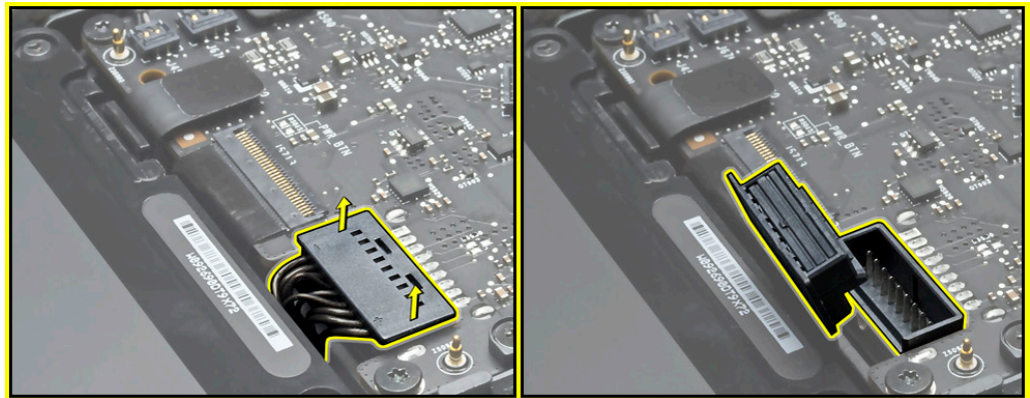



Serial Number Location

Turn over the computer to see the serial number etched on the bottom case front.





Transferring the Serial Number

When replacing a bottom case, retain the customer's bottom case until the repair is complete. Before installing the replacement bottom case, use a fine tip permanent marker to write the original serial number clearly and legibly in uppercase box letters directly onto the inside of the new bottom case.

CAUTION: Take great care in deciphering the small typeface of the etched serial number on the bottom case. You might need a magnifying glass to see it clearly. It is imperative that you transfer the correct alphanumeric characters. Keep in mind that Apple serial numbers always use the numbers 1 and 0 instead of the Roman letters "l" and "O."



Note About Images In This Guide

Because a pre-production model was used for most of the images shown in this guide, you may notice small differences in appearance between the image pictured and the computer you are servicing. However, although the appearance may differ, the steps and sequence are the same unless noted.



Caution About Ordering Replacement Parts

Caution: Some modules have more than one part number due to different product configurations. **Before ordering a replacement part, ALWAYS enter the product serial number in GSX to find the compatible part.**

Troubleshooting

MacBook (13-inch, Late 2009)



General Troubleshooting



Update System Software

Important: Whenever possible before beginning troubleshooting, ensure the latest software and firmware updates have been applied.

Troubleshooting Theory

For general information on troubleshooting theory, go to GSX and find the Service Training course menu link. From there you can access the Troubleshooting Theory self-paced course.

Hardware vs. Software

For information on how to isolate a hardware issue from a software issue, refer to:

TS1388—Isolating issues in Mac OS X <<http://support.apple.com/kb/TS1388>>

TS1394—Mac OS X: Troubleshooting installation and software updates <<http://support.apple.com/kb/TS1394>>

HT2956—Troubleshooting Mac OS X installation from CD or DVD <<http://support.apple.com/kb/HT2956>>

For information on how to troubleshoot a software issue, refer to:

HT1199—Mac OS X: How to troubleshoot a software issue <<http://support.apple.com/kb/HT1199>>



MacBook (13-inch, Late 2009): Functional Overview

Refer to this diagram for symptoms related to logic board connectors. To more easily view this page, select the Rotate command.

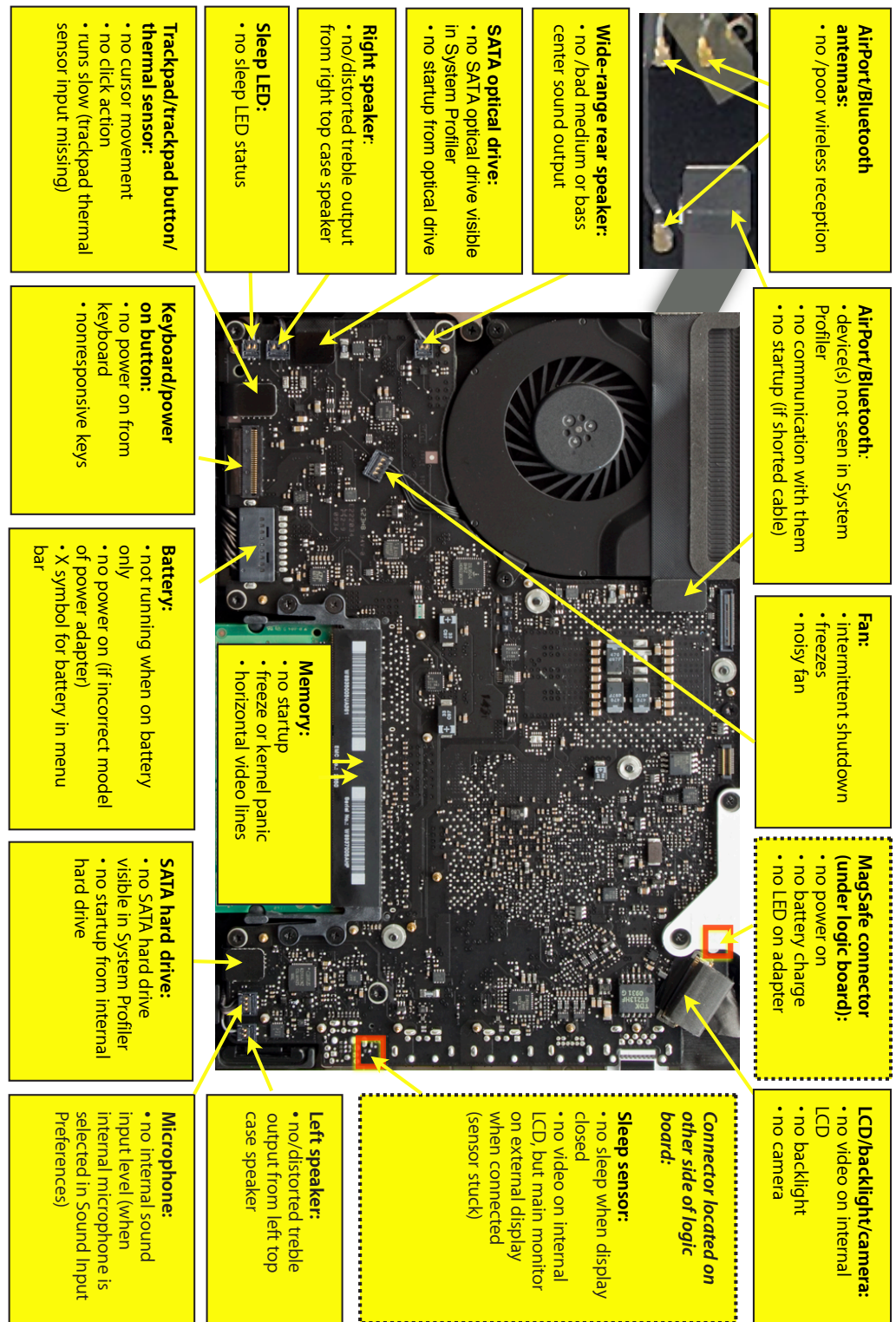



MacBook (13-inch, Mid 2010): Functional Overview

Refer to this diagram for symptoms related to logic board connectors. To more easily view this page, select the Rotate command.

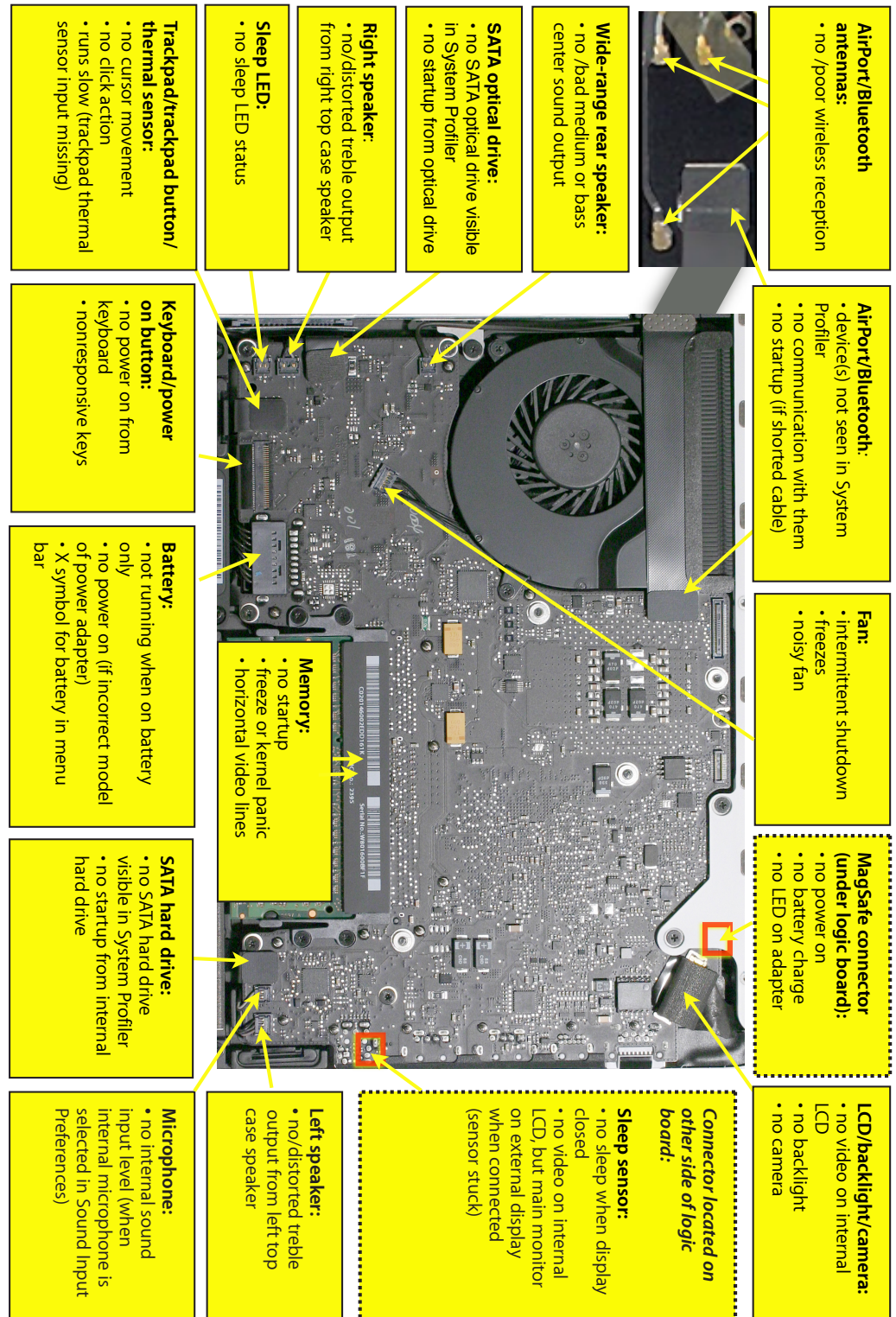



MacBook (13-inch, Late 2009): Block Diagram

Refer to this diagram to see how modules are interrelated.

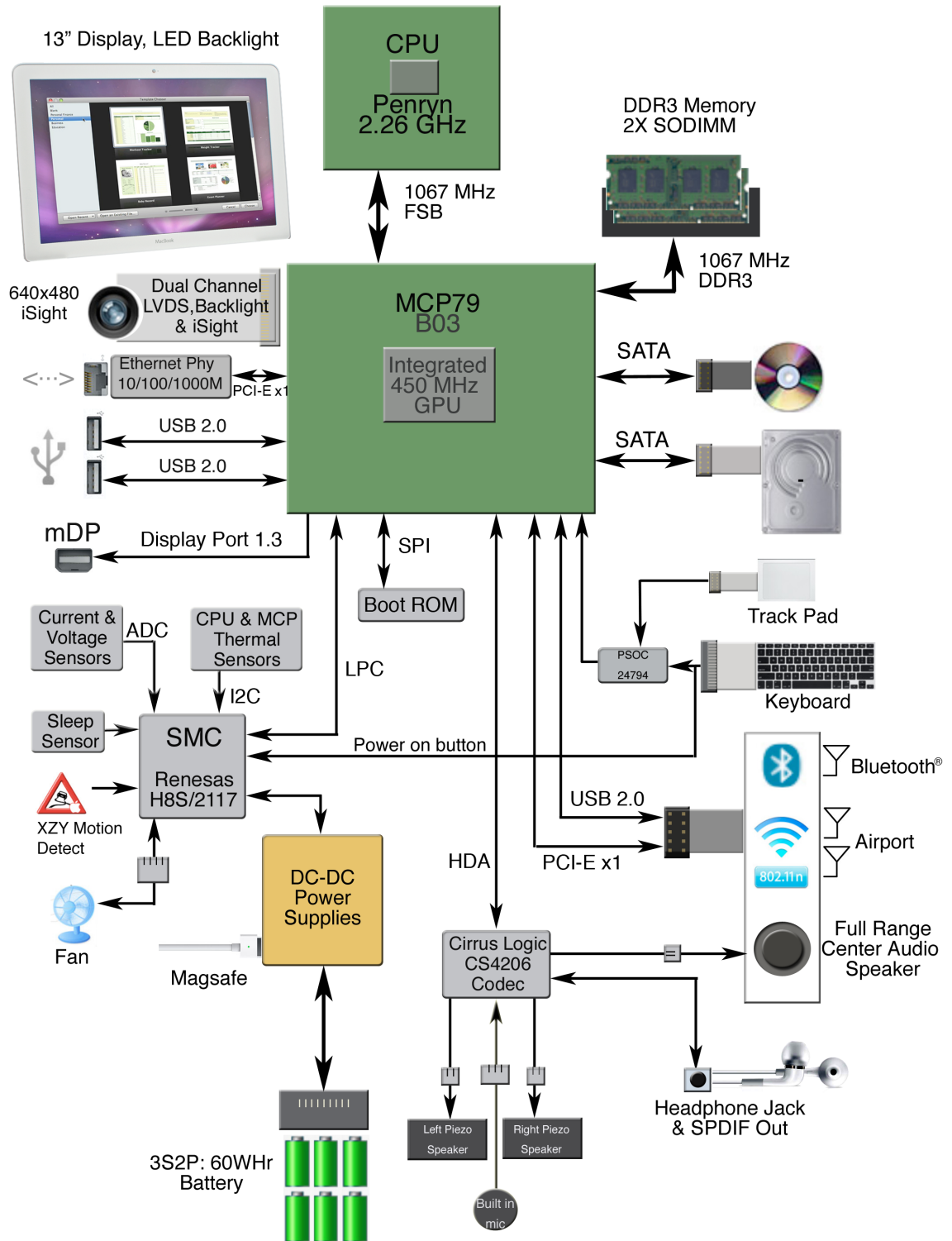



MacBook (13-inch, Mid 2010): Block Diagram

Refer to this diagram to see how modules are interrelated.

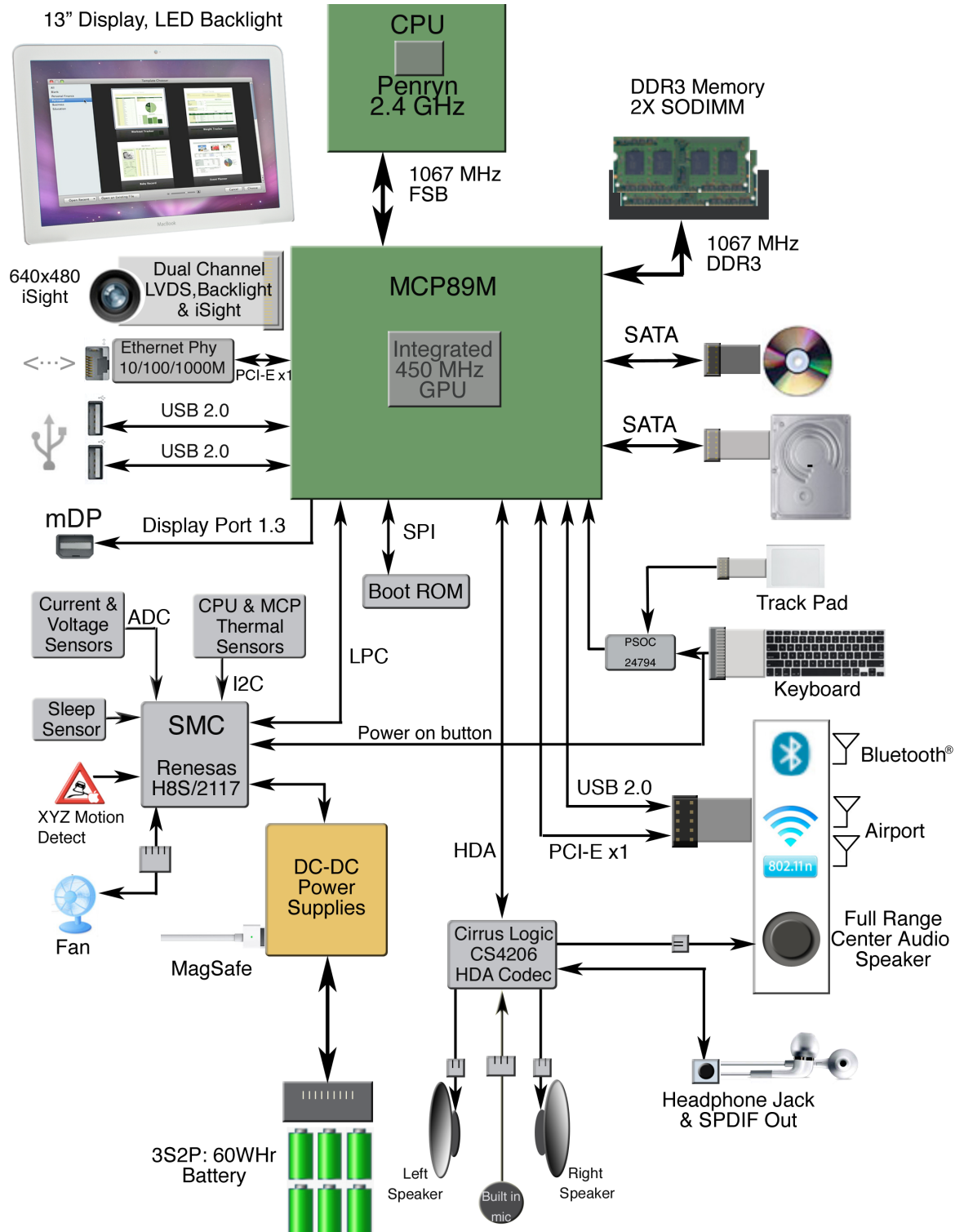



Liquid Contact Indicators

Liquid contact indicators (LCI) have been added to specific locations on current Mac portables to help determine if systems have been damaged by liquid. The sensors are only visible when the bottom case and some of the modules have been removed. Normally represented by small white dots, the LCIs turn red when they have come in contact with liquid, such as an accidental spill.

For more information, refer to Knowledge Base article HT3400: “About Liquid contact indicators (LCI) on portable and desktop computers.” <http://support.apple.com/kb/HT3400>

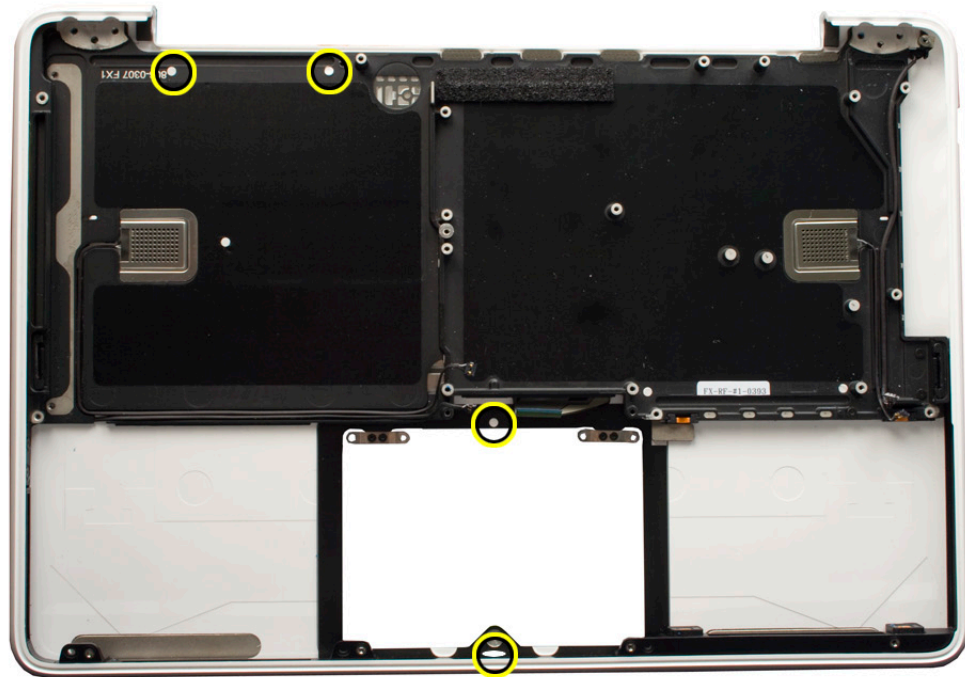



Common Reset Procedures

Resetting the System Management Controller (SMC)

To reset power management via the SMC chip:

1. If the computer is on, turn it off by choosing Shutdown from the Apple () menu.
2. Connect the power adapter to the computer and to a working power source.
3. **Important:** Use the keys on the left side of the keyboard. On the built-in keyboard, press Shift-Control-Option along with the power button once.
Note: When the LED on the MagSafe connector is orange, resetting the SMC will change it to green for a few seconds, indicating that SMC was correctly reset.
4. Wait 5 seconds and press the power button to restart the computer. **Note:** If bottom case is removed, you may alternately reset the SMC by disconnecting the power adapter and the main battery, and holding the power button down for five seconds.

For more information:

<http://www.apple.com/support>

HT3964—Intel-based Macs: Resetting the System Management Controller (SMC) <<http://support.apple.com/kb/HT3964>>

Resetting the Parameter RAM (PRAM)

To reset PRAM,

1. If the computer is on, turn it off.
2. Locate the following keys on the keyboard: Command, Option, P, and R. You will need to hold these keys down simultaneously in Step 4.
Note: If the keyboard does not have an Option key, use the Alt key instead.
3. Turn on the computer.
4. Press and hold the Command-Option-P-R keys.
Important: You must press this key combination before the gray screen appears.
5. Hold down keys until the computer restarts, and you hear the startup chime a second time.
6. Release the keys.

For more information:

<http://www.apple.com/support>

HT1379—Resetting your Mac's PRAM and NVRAM <<http://support.apple.com/kb/HT1379>>



Starting Up in Safe Mode

A Safe Boot is a special way to start Mac OS X when troubleshooting. To start up into Safe Mode (Safe Boot):

1. Make sure the computer is shut down.
2. Press the power button.
3. Immediately after you hear the startup tone, press and hold the Shift key.
Note: The Shift key should be held as soon as possible after the startup tone but not before.
4. Release the Shift key when you see the screen with the gray Apple and progress indicator (looks like a spinning gear). During startup, "Safe Boot" appears on the Mac OS X startup screen. To leave Safe Mode, restart the computer normally, without holding down any keys during startup.

For more information:

<http://www.apple.com/support>

HT1564—What is Safe Boot, Safe Mode? <<http://support.apple.com/kb/HT1564>>

TS1884—Safe Boot take longer than normal startup <<http://support.apple.com/kb/TS1884>>

Apple Service Diagnostics

Run Apple Service Diagnostics to determine if any of the thermal sensors are malfunctioning. When sensors fail, replace the corresponding part—logic board, battery, or top case. See chart below for correlation between error code and part.

Name	Location
TC0D	Logic board
TC0P	Logic board
Th1H	Logic board
TN0D	Logic board
Ts0P	Trackpad flex cable
TB0T	Battery
TB1T	Battery
TB2T	Battery
TB3T	Battery

From the main Service Source page, click Disc Images for diagnostic software.



Clamshell Service Diagnostic Read Me

Isolating video and wireless issues in portable computers can be time consuming and confusing. The Clamshell Service Diagnostic (CSD) is a new diagnostic tool that checks Apple's latest portable computers for the presence of AirPort, Bluetooth, LCD and Ambient Light Sensor (ALS) to assist you in quickly making a failure determination.

Troubleshooting benefits of using CSD include:

- Quick way (less than 1 minute) to determine whether clamshell-related modules (AirPort, Bluetooth, LCD and ALS) are electrically connected without taking apart the system.
- Results of CSD can help pinpoint if any clamshell cables may need to be reseated to logic board.
- Diagnostic results can help isolate a video or wireless issue to either the clamshell or the logic board, to avoid unnecessary replacements of these components.

CSD checks for the presence of the computer's:

- AirPort
- Bluetooth
- LCD
- ALS

CSD does not check for the presence of the computer's:

- iSight camera
- externally connected hardware components (such as USB or FireWire devices)

CSD does not check for issues with the OS X or other software-related problems such as application or extension conflicts.

Display Issue: Pixel Anomalies

When displaying a single color over the screen area, the LCD panel might show one or more pixels that are not properly lit. To determine if the display has an acceptable number of pixel anomalies, follow the steps below:

1. Set the display image to one of the following colors: all-white, all-red, all-green, all-blue, or all-black display. (From the main Service Source page, click Disc Images for the diagnostic software that will generate these patterns on the screen.)
2. Using a jeweler's loupe, pocket microscope, or other magnifying device, identify and count each pixel anomaly:

Bright subpixel anomaly = subpixel that is always on

Dark subpixel anomaly = subpixel that is always off

3. The number of acceptable pixel anomalies for this computer is:

Bright	Up to 3
Dark	Up to 5
Combination	Up to 7



4. If the number of subpixel anomalies exceeds the acceptable number shown above, replace the LCD panel display assembly. Numbers outside the acceptable range would be:

Bright	4 or more
Dark	6 or more
Combination	8 or more

5. If the number of subpixel anomalies is acceptable, explain to the customer that the pixel anomalies are within specifications, and no repair is necessary.

Important: Do not release the specifications to customers. Instead, inform them that a certain number of subpixel anomalies are considered acceptable, and these factors apply to all manufacturers using LCD technology—not just Apple products.

When speaking with customers, please use the following explanation:

Active-matrix LCD technology uses rows and columns of addressable locations (pixels) that render text and images on screen. Each pixel location has three separate subpixels (red, green, and blue) that allow the image to be rendered in full color. Each subpixel has a corresponding transistor responsible for turning the subpixel on or off.

There are typically millions of these subpixels on an LCD display. For example, the LCD panel used in the Apple Cinema HD display is made up of 2.3 million pixels and 6.9 million red, green, and blue subpixels. Occasionally, a transistor does not work perfectly, which may result in the affected subpixel being turned on (bright) or turned off (dark). With the millions of subpixels on a display, it is quite possible to have a low number of faulty transistors on an LCD. Therefore, a certain number of subpixel anomalies are considered acceptable. Rejecting all but perfect LCD panels would significantly increase the retail price for products using LCD displays. These factors apply to all manufacturers using LCD technology—not just Apple products.



Symptom Charts

Follow the steps in the order indicated below. If an action resolves the issue, retest the system to verify. **Note:** A compilation of Quick Check tables is available at <http://service.info.apple.com/QRS/en/quickreference.pdf>.

Note: There is no silk-screen text on final production logic boards. The photos shown with test points are from pre-production units and are solely for reference.

Startup and Power Issues

No Power

Unlikely cause: display assembly, speakers, optical drive, hard drive

Quick Check

Symptom	Quick Check
No Power / Dead Unit <ul style="list-style-type: none"> No power No image No startup chime No fan or hard drive spin No reset sound from optical drive No sleep LED activity No light if Caps Lock pressed Non-operational 	<ol style="list-style-type: none"> Verify AC power presence with MagSafe LED indicating on, or in charge state. Verify unit's power adapter on a known-good system. Reset SMC. Run Battery Diagnostic Utility.

Deep Dive

Check	Result	Action	Code
1. Test unit's AC adapter on a known-good system, and verify that it can power and charge the battery.	Yes	AC adapter OK. Go to step 2	
	No	Go to step 3.	P01



2. Connect known-good and correct model of AC adapter to unit and verify that it can be powered on.	Yes	Go to step 5.	
	No	Go to step 9.	
3. Inspect unit's AC adapter and verify that cable and MagSafe connector have no damage and are clean and free from defects.	Yes	Replace AC adapter	P01
	No	Clean connector assembly, release any stuck pin then retest AC adapter on a known-good system. If damaged, replace AC adapter for following symptoms: -damaged /burnt pins, -damaged wire, If still no power go to step 4	P15 P16
4. Run Battery & Adapter Diagnostics utility on a known-good system and verify that adapter health is good.	Yes	Retest AC adapter on unit	
	No	Replace AC adapter if failing Adapter Diagnostics test	P14
5. Reset SMC. Connect known-good AC adapter and startup unit to verify that battery is recognized and charges.	Yes	Corrupt SMC state prevented battery management. Issue resolved with SMC reset.	
	No	Go to step 6	
6. Verify that battery connector is correctly seated and does not have any damaged or bent pin.	Yes	Battery connector has no visible damage. Go to step 7.	
	No	Reseat battery connector and retest. If physical damages are found, replace damaged parts and retest: -damaged battery, -damaged logic board	P11 M20



7. Unit's battery may be run down, or not recognized. Run Battery Diagnostic utility and verify the battery health.	Yes	Battery health is reported good . Let battery fully charge and retest. If system still does not run from battery only, go to step 8.	
	No	Battery health is not reported good: Replace unit's battery according to test failure result: <ul style="list-style-type: none">- for not charging,- for not recognized,- for a consumed battery customer will need to purchase a replacement one.	P10 P11
8. Substitute unit's battery with a known-good one to verify that system starts on battery.	Yes	Replace unit's battery.	P11
	No	Replace logic board.	M20
9. Inspect MagSafe port on computer for physical damage, debris or metal fragments attracted to magnetic connector and verify that MagSafe connector is clean and free from defects.	Yes	Go to step 10	
	No	Clean port assembly. Replace MagSafe board if necessary.	X03
10. Verify adapter status LED turns on green or orange indicating power or battery charge in progress. A green LED can indicate a full battery or a battery not recognized.	Yes	MagSafe LED on indicates power is flowing to logic board. Go to step 12	
	No	Go to step 11	
11. Reset SMC. Verify that system powers on after SMC reset.	Yes	Corrupt SMC state prevented system power. Issue resolved with SMC reset.	
	No	Go to step 12.	

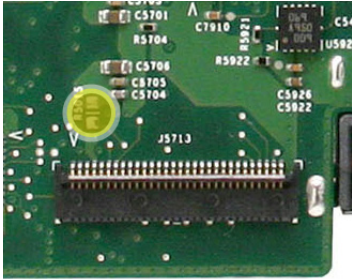
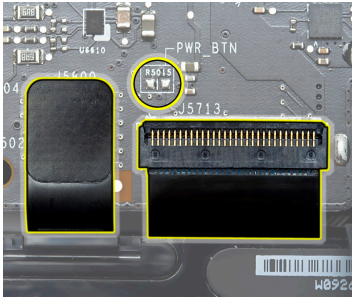

<p>12. Reseat the keyboard flex cable to logic board. A disconnected keyboard or a stuck/open power-on key can disable system powering on. If power button does not work, use jeweler's flatblade screwdriver to short the Power On pads on logic board (see image, left) to power up the logic board. If power-on key is stuck, keyboard flex cable might need to be disconnected before shorting pads. Verify that system powers on.</p>	Yes	Power on key works fine, issue resolved.		
		Power on key works when keyboard cable is resealed.		
		Power on key appears to be stuck, had to remove keyboard cable to power on. Replace top case for stuck power on key.	K05	
	<p>13. Remove logic board and verify that the MagSafe connector is correctly connected underneath logic board.</p>	No	No logic board power on when shorting power-on pads. Go to step 13	
		Yes	Replace MagSafe board; retest.	X03
			With replaced MagSafe board and known-good AC adapter connected, short Power On pins. If system still does not power on, replace logic board.	M01
No	Reseat MagSafe connector on logic board and retest.			



Won't Start Up

Unlikely cause: display assembly, speakers, fan, camera, microphone

Quick Check

Symptom	Quick Check
<p>Power but No start up</p> <ul style="list-style-type: none"> No startup chime, some video activity, Apple logo, startup spin dial Startup chime with possible beep tones Fan, hard drive spin or optical drive reset sound Sleep LED is on, blinking or went out Caps Lock LED toggles when pressed Gray screen at startup (trackpad disconnected) 	<ol style="list-style-type: none"> Reset SMC. Verify startup process passes initial memory checks – no beep errors or flashing sleep LED indicators. Display activity is starting up. Clear PRAM. Verify starts up from user drive. Connect known-good external bootable device and press Option (Alt) key during startup; then select external startup device to bring up system for diagnostics. Verify presence and status of user hard drive. Use Disk Utility to repair drive and file permissions. Ensure trackpad cable is connected to prevent a gray screen at startup. Check trackpad connection to logic board rather than assuming the logic board or display module is at fault.

Deep Dive

Check	Result	Action	Code
1. Reset SMC and Clear PRAM to set default startup device to internal hard disk drive (HDD).	Yes	Unit's hard drive bootable, issue resolved default settings.	
	No	Computer not starting up, go to step 2	
2. Check that trackpad cable is well seated before startup. Otherwise system could start up with gray screen.	Yes	Go to step 3.	
	No	Connect trackpad, reboot to verify issue resolved. Go to step 1.	
3. Verify that system is indicating a memory error by repeating flashing sequence of sleep LED 1 or 3. (Beep tones if sound is enabled.)	Yes	Troubleshoot memory issues, go to step 4.	
	No	Continue with startup sequence verification go to step 5.	



4. Reseat unit's memory and/or test with known-good memory to isolate bad memory. Verify that issue does not reoccur after replacing bad memory.	Yes	Replace defective unit's memory card. Continue to verify startup process. Go to step 6.	X02
	No	Should known-good memory fail in one or more slots, replace logic board.	M07
5. Hold the Option (Alt) key during startup, and then verify presence of bootable hard drive in Startup Manager. Select unit's hard drive and verify that unit starts up from this drive.	Yes	System starting up from unit's hard drive. Startup issue resolved	
	No	Unit's hard drive not present or does not start up from this drive. Continue to find bootable device. Go to step 6.	
6. Insert Mac OS install disc in optical drive. Install disc is bootable and should be present in Startup Manager when Option (Alt) key is pressed on startup. Verify that unit starts up from OS install disc.	Yes	Starts up from optical drive - unit's hard drive not yet bootable, go to step 9.	
	No	Computer has no internal bootable devices. Test external startup devices, go to step 7.	
7. Boot from a known-good (bootable) OS from a USB drive or network server. Using System Profiler and Disk Utility, verify that internal mass storage devices are available.	Yes	System started up from external device and reports data regarding internal SATA devices. Go to step 8.	
	No	No startup devices available. Replace logic board	M02
8. Troubleshoot optical drive with a known-good part and the optical drive cable by reseating it. Verify that issue does not reoccur with reseated cable and known-good part.	Yes	Cable reseat solved issue. Continue to verify hard drive issues, go to step 9.	
		Defective optical drive cable found and replaced. Continue to verify hard drive issues, go to step 9.	X03
		Defective optical drive found and replaced. Continue to verify hard drive issues, go to step 9.	J03
	No	Replace logic board	M19



9. Use Disk Utility loaded from OS Install disc to verify that hard drive is available on the left side device list.	Yes	Unit's hard drive available for inspections and repair. Go to step.	
	No	Hard drive not present, troubleshoot hard drive and cable. Go to step 10.	
10. Troubleshoot hard drive with a known-good part and the SATA cable by reseating it. Verify that issue does not reoccur with reseated cable and known-good part.	Yes	Unit's hard drive visible in Disk Utility after reseating SATA cable; go to step 11.	
		Unit's hard drive visible in Disk Utility after replacing defective SATA cable; go to step 11.	X03
		Suspect unit's hard drive defective, attempt OS restore, go to step 11.	
	No	Known-good hard drive and known-good hard drive SATA cable used, still no hard drive present. Replace logic board	M19
11. Try to boot system with the Shift key kept pressed until spinning icon appears, and verify that it boots to login window.	Yes	Go to software troubleshooting article http://support.apple.com/kb/TS1388	
	No	Go to step 12.	
12. Use Disk Utility to repair unit's hard drive. If there is an installed OS on hard drive, also correct permissions Verify OS startup functionality after Disk Utility repairs.	Yes	OS on unit's hard drive repaired, issue resolved.	
	No	Hard drive not bootable, perhaps missing OS, go to step 13.	
13. Use Disk Utility to partition unit's hard drive with one GUID partition; then restore OS using unit's original Mac OS install disc. Verify that hard drive is bootable after OS install.	Yes	Unit's hard drive now starts up from new OS image, issue resolved	
	No	Replace hard drive.	H02



Intermittent Shutdown

Unlikely cause: hard drive, optical drive

Troubleshooting Shutdown Issues

Before troubleshooting shutdown issues, always do the following:

- Run the available Apple diagnostics to check for cause of previous shutdown(s). Running ASD also helps isolate any abnormal value reading from a thermal, voltage, or current sensor or from a fan speed meter.
- Collect all available information from the user on shutdown details: periodicity, power state when issue happens, running applications, running time before shutdown.

User-related shutdowns

A computer shutdown may be caused by user operation. Shutting down the computer (by selecting the Shut Down menu, by pressing the power button for at least 4 seconds, or by programming a timed shutdown in the Energy Saver preferences) should not be considered as a failure unless the power button or the magnetic sleep sensors are found to be defective.

Suggested steps for troubleshooting:

- Reset SMC.
- Check Energy Saver preferences settings.
- Test top case button and magnetic sleep sensor operation and secure connection to logic board.

Activity-related system shutdowns

These shutdowns are linked to system settings, devices drivers, applications, or operating system freezes.

- System could not finish the standard shutdown process and had to force shutdown.
- An installed watchdog detected that an application did not respond within the specified time. (This watchdog can be enabled in Mac OS X Server Energy Saver preferences.)

Suggested steps for troubleshooting:

- Check the system logs and activity monitor utility for clues on the freezing process.
- Check for available software and firmware updates for installed device drivers, applications, or operating system.
- Start the system from a known-good and up-to-date bootable drive for issue reproduction.

Power-related system shutdowns

These shutdowns are due to power management, poor connections or defective power sources.

- External or battery power source was removed.
- Battery went empty while computer was on.
- Battery went empty while computer was asleep.



Suggested steps for troubleshooting:

- Reset SMC.
- Check that AC cable, AC adapter and battery connections are secure to logic board.
- Verify battery and power adapter sources using the Battery and Adapter test utility.

Hardware-related system shutdown

These shutdowns are due to temperature, voltage, current, fan speed or other hardware-related sensor values going out of range.

- One of the temperature sensors reached a specified temperature limit.
- One of the voltage sensors reached a specified voltage limit.
- One of the current sensors reached a specified current limit.

Suggested steps for troubleshooting:

- Check all sensors connections and values using Apple Service Diagnostics and other available Apple Service utilities.
- Confirm correct Apple-branded battery and power adapter are installed.
- Check for abnormal battery temperature.
- Check fan(s) operation.
- Confirm cleanliness of heatsink fins and air flows.
- Confirm heatsink is correctly seated on logic board and thermal material is present.

Quick Check

Symptom	Quick Check
Intermittent shutdown <ul style="list-style-type: none"> • Powers off during startup • Powers off with desktop use 	<ol style="list-style-type: none"> 1. Collect details from customer on shutdown occurrence and system configuration when it happens (on battery, when running for a while, frequency of shutdowns, running applications, shutdown repeatability). If shutdown can be easily reproduced, check next steps: 2. Verify battery charge status 3. Check AC adapter MagSafe connector and connection with system 4. Reset SMC and PRAM 5. Start up with shift key down for safe mode 6. Startup from known-good bootable device 7. Run ASD for sensors + thermal tests



Deep Dive

Check	Result	Action	Code
1. Activity related shutdowns: Reset SMC and PRAM and verify that shutdown issue still happens.	Yes	Check with known-good bootable drive: go to step 2	
	No	Shutdown cause was related to SMC or Pram programmed shutdown settings or corruption, and was resolved by reverting them to default settings.	
2. Booting from known-good bootable drive , verify that shutdown issue still happens.	Yes	Go to Power related shutdowns on step 3	
	No	Shutdown events do not happen on known-good OS. Reinstall Mac OS on customer hard drive, update OS with latest version and check if any firmware update is available.	
3. Power related shutdowns : verify that shutdown issue can ONLY be reproduced with user's battery and AC adapter.	Yes	Intermittent power issue means checking user's AC cable for intermittent connection, checking user's battery and AC adapter health,	
	No	Issue also happens with known-good battery and AC adapter. Go to step 4	
4. Reset SMC and PRAM, then verify if shutdown symptoms does not happen anymore.	Yes	Shutdown cause was related to SMC or Pram settings or corruption, and was resolved by reverting them to default settings.	
	No	Shutdown event still occurs. Go to step 5.	



5. Check system running on battery only. Use known-good charged battery. Verify if shutdown/reset/sleep issues disappear when known-good battery is used without AC adapter.	Yes	Recharge customer battery and retest. Check for customer battery health in Apple System Profiler or run Battery & Adapter Test utility, and replace battery if its health is reported bad or consumed.	P09
	No	Symptoms unchanged - Go to step 6	
6. Check with known-good AC adapter source only Remove battery and use known-good AC adapter. Verify if the shutdown/reset/sleep issues disappear with known-good adapter.	Yes	Faulty user's AC adapter. Replace user's AC adapter if AC cable and duckhead were confirmed good.	P14
	No	Symptoms unchanged - Go to Hardware-related shutdowns on step 7	
7. Hardware-related shutdowns: Run ASD and verify if a sensor failure is reported.	Yes	-If a temperature or a fan sensor failure is reported, go to step 8 -If a voltage or a current sensor failure is reported in ASD w/known good AC adapter and batteries, replace logic board.	M23
	No	Setup ASD to loop test suite for burn in tests and go to step 7. if no failure is found after burn in tests, return unit to customer for no failure found.	



8. Verify if a thermal sensor or fan failure is reported in ASD.	Yes	<p>-If fan not running failure, check for fan cable seating and retest. If same failure after retest replace fan with known-good fan and retest. If issue does not happen with known-good fan, replace user's fan.</p> <p>-If an over temp failure reported, check for cause of over temp, like obstructed vent, dust in heatsink fin, clogged fan and retest. If still failing replace part where sensor is located (logic board, battery, or trackpad) according to the sensor location table . Go to step 9</p>	X22 M23 P17 K99
	No	Replace Thermal module Go to step 9	X10
9. Isolate if issue solved Verify if shutdown/issue does not happen anymore after part exchange.	Yes	Issue fixed	
	No	Replace logic board with corresponding symptom: -if for thermal error cause -if for other cause	M18 M08



No Video/Bad Video

Unlikely cause: hard drive, optical drive, top case, battery, power adapter

Quick Check

Symptom	Quick Check
Power, but No Video <ul style="list-style-type: none"> • Power • No video • fan, hard drive spin, or optical drive reset sound • sleep LED is on or was on then went off • light if Caps Lock pressed • gray screen at startup (trackpad disconnected) 	<ol style="list-style-type: none"> 1. Adjust Brightness using brightness (F1/F2) keys 2. Reset SMC. 3. Reset PRAM. 4. If no startup chime, verify with known-good memory. 5. Verify with external monitor. 6. Press Option (Alt) key on startup. 7. Ensure trackpad cable is connected to prevent a gray screen at startup. Check trackpad connection to logic board rather than assuming the logic board or display module is at fault.

Deep Dive

Check	Result	Action	Code
1. Characterize issue. Define whether the issue is a bad image with backlight OR a no video issue. Verify if image (even distorted) is visible.	Yes	Bad image quality; refer to Display symptom charts	
	No	No image seen or an image is seen but without backlight, go to Step 2.	
2. Reset SMC Reset SMC and verify that system video is displayed.	Yes	Corrupt SMC State prevented video.	
	No	Go to Step 3.	
3. Check that trackpad cable is well seated before startup. Otherwise system could start up with gray screen.	Yes	Go to step 4.	
	No	Connect trackpad, reboot to verify issue resolved. Go to step 2.	
4. Reset PRAM. If no action, use external keyboard with same sequence. Verify that correct system video is displayed.	Yes	Invalid or Corrupt PRAM contents affecting video output	
	No	Go to step 5.	



5. Test external video. Connect a known-good external display to the system, press power button and close display to force main screen startup on external display. Verify that video is correct on external display.	Yes	Video correct on external display. Research available firmware and software updates and retest. If returning with already up to date software, go to Step 6.	
	No	No video on external display. Replace logic board with according symptom code: -no video -bad/distorted video	M03 M04
6. Isolate LCD display detection Disconnect external display, reopen display and restart system. Verify that sleep LED indicator goes off after power on, indicating that internal LCD has been detected.	Yes	Sleep LED going off means that LCD has been detected: Go to step 8.	
	No	Internal LCD is not detected. Check display cable: Inspect display cable for damage on connector or cable: -if damage is found, replace display module and retest, -if no damage, run Clamshell Service Diagnostic utility and verify LCD panel presence. If not found, reseal connector on logic board and retest. When retesting, if the sleep LED remains on after system is powered, go to step 7.	L18
7. Check for a sleep sensor stuck condition. When sleep sensor is stuck, blank video will appear temporarily on internal display, until the OS detects the sleep sensor state and sleeps the system. Verify that system starts up with video on internal display and will sleep with sleep LED pulsing.	Yes	Sleep sensor is stuck. Replace logic board.	M22
	No	Symptom unchanged - Sleep LED stays on forever. Go to Step 7.	



<p>8. Check for No Backlight Condition. Power on system and verify with a bright (low heat) flashlight that a faint image is seen on display when system is powered on.</p>	Yes	<p>Faint video is visible but no backlight. Inspect display connector and cable for damage.</p> <ul style="list-style-type: none"> -If damage is found, replace display module and retest -If no damage, run Clamshell Service Diagnostic utility and check verify LCD panel presence. If not found, reseal cable and retest. If still no backlight , replace display module . <p>Go to step 10.</p>	<p>L18</p> <p>L09</p>
	No	<p>No faint video can be seen when using a bright (low heat) flashlight; replace display module and retest.</p> <p>If issue persists, go to step 9.</p>	<p>L09</p>
<p>9. Verify with known-good display. Connect known-good display module to user's computer.</p>	Yes	<p>System is functioning with known-good display module. Replace user's display module with related symptom:</p> <ul style="list-style-type: none"> - had no power issue - had blank video - had no backlight 	<p>L01</p> <p>L03</p> <p>L09</p>
	No	<p>Symptoms unchanged - Go to step 10.</p>	
<p>10. With reseated display cable or replaced display module, verify that system now has video and backlight.</p>	Yes	<p>Issue was due to unseated connector, damaged cable or defective display module.</p>	
	No	<p>Previous display module cable damaged the logic board. Remove rear vent and check backlight fuse (see good fuse on left). If fuse is blown, replace logic board.</p>	<p>M25</p>





Battery Isn't Recognized or Won't Charge

Unlikely cause: display assembly, speakers, optical drive, hard drive, trackpad

Quick Check

Symptom	Quick Check
Battery isn't recognized or won't charge <ul style="list-style-type: none"> AC adapter No MagSafe LED indicator No orange charge indication X on Battery in status menu no lightning icon on Battery in status menu when battery needs to be charged.. 	<ol style="list-style-type: none"> Check battery level in menu bar, and test AC power. Reset SMC by pressing the (left) Shift-Control-Option keys along with the power button once. Make sure that customer has correct adapter model for this system Test unit's battery, using Notebook Battery and Adapter Diagnostic.

Deep Dive

Check	Result	Action	Code
1. Verify that the MagSafe LED goes green to amber when connected to the system.	Yes	Battery is recognized and charging. Go to step 7.	
	No	LED is green, Battery may be either fully charged or not recognized. Go to step 2.	
		LED was on momentarily then went out. Go to No Power troubleshooting table.	
2. Startup unit and verify that unit detects an installed battery in menu bar icon.	Yes	Go to step 3.	
	No	Go to step 8	
3. Verify that battery menu indicates a fully charged battery	Yes	Unit's battery charged. Run Notebook Battery and Adapter Diagnostic to check for battery health. Go to step 7.	
	No	Go to step 4	
4. Verify whether the battery menu shows an X meaning that battery is not recognized.	Yes	Go to step 5.	
	No	Go to step 7.	



5. Inspect unit's battery contacts and battery cable connector for corrosion or obstructions.	Yes	Clear obstructions or replace battery if cable corroded; retest.	X03
	No	Go to step 6.	
6. Reseat battery harness at logic board connector, and retest. Verify that battery is recognized and charging.	Yes	Issue resolved by cable reseat.	
	No	Check battery health. Go to step 7.	
7. Run Notebook Battery and Adapter Diagnostic to check for battery health. Verify that reported battery status= Good.	Yes	Battery health status is Good. Go to step 10.	
	No	Go to step 8	
8. Verify that reported battery status health is Consumed (Depleted).	Yes	Battery is consumed; customer needs to purchase a replacement	
	No	Go to step 9.	
9. Reported battery status health is Defective (Bad). Verify whether battery is still covered by Apple 1-year warranty	Yes	Battery is still covered by Apple one year warranty. Replace defective battery with relevant symptom code: -Battery - Runtime Too Short -Battery - Will Not Charge -Battery - Not Recognized -Battery - Won't Run.	P09 P10 P11 P12
	No	Battery exceeds one-year warranty coverage; customer needs to purchase a replacement	
10. Health of the battery is reported "Good." Verify that battery is still covered by Apple one year warranty.	Yes	Battery function normal. If issue remains, go to step 11.	
	No	Battery is out of 1-year warranty coverage. Battery should continue to function until consumed. If issue reoccurs, customer will need to purchase a replacement.	
11. With battery charge greater than 20% verify that battery supports system operation without AC connected.	Yes	Unit's battery is good	
	No	Go to step 12	
12. Test with a known-good charged battery only. Verify that system supports running from battery only.	Yes	Replace battery	P12
	No	Replace logic board	M20



Kernel Panic/System Crashes

Unlikely cause: Battery, Power Adapter

Quick Check

Symptom	Quick Check
Memory Issues/Kernel panic and freezes <ul style="list-style-type: none"> • Display notice of system kernel panic during start up and desktop use. • System freeze during use. • System freeze upon wake from sleep. 	<ol style="list-style-type: none"> 1. Reset SMC and clear PRAM 2. Remove suspect external devices. 3. Verify memory cards are Apple-approved memory, and memory configuration matches memory installed. 4. Start up with shift key down for safe mode. 5. Startup from known-good bootable device 6. Check panic.log info for crash cause 7. Run AHT/ ASD for sensors test

Deep Dive

Check	Result	Action	Code
1. Isolate Peripherals as cause. Disconnect all peripherals, external devices, and display adapters if present	Yes	Suspect peripherals as cause. Reconnect one at a time, verifying unit operation at each stage	
	No	Go to Step 2	
2. Reset SMC and clear PRAM then verify that unit starts without panic issues.	Yes	Issue resolved with default startup settings.	
	No	Go to step 3	
3. Boot in Safe Mode with Shift key down, and check for recent kernel panic data in panic log. Open Panic.log file on hard drive and check for affected interface that crashed. If unit still crashes during startup, you will need to take out disk to a good system to access the file. Verify that kernel panic dependency is not listed to an I/O interface.	Yes	Kernel Panic is not a system I/O related device. Go to step 4	
	No	I/O device related crash, go to step 5	



<p>4. Kernel Panic is not a system I/O related device. Reseat memory or replace suspect memory with known-good memory. Verify that issue does not reoccur.</p>	Yes	Issue appears to be due to memory card badly seated or defective memory card. Retest one by one with known-good memory. If confirmed, replace affected memory card.	X01
	No	Go to step 5.	
<p>5. Remove I/O device where possible to pinpoint faulty device:</p> <ul style="list-style-type: none"> - Disconnect AirPort/Bluetooth card cable on logic board. (Cable can be disconnected without affecting hard disk startup and test). - Disconnect optical drive cable to isolate optical drive (Cable can be disconnected without affecting hard disk startup and test). - Disconnect hard drive cable to isolate hard drive (Cable can be disconnected without affecting startup from a bootable optical drive media and test). <p>Verify each time if issue disappears when device is disconnected..</p>	Yes	<p>System starts up when I/O device removed, replace affected I/O device or module containing it.</p> <p>-If issue does not happen anymore after AirPort/Bluetooth cable has been disconnected from logic board, replace AirPort/Bluetooth cable .</p> <p>If still issue, replace AirPort/Bluetooth card</p> <p>-If issue does not happen anymore after optical drive has been disconnected, replace optical drive cable and retest. If issue remains try with known-good optical drive: if still issue, replace logic board</p> <p>-If issue does not happen anymore after hard drive has been disconnected, replace hard drive cable and retest. If issue remains, try with known-good hard drive. If still issue, replace logic board.</p>	<p>X03</p> <p>N13</p> <p>X03</p> <p>M06</p> <p>X01</p> <p>M06</p>
	No	Symptoms unchanged, go to step 6	
<p>6. Start up from optical drive or known-good OS. Attempt to start up with original Mac OS install disc, or from an external hard drive with known-good Mac OS installed, and verify that unit starts without kernel panic.</p>	Yes	Kernel panics cease running alternate OS. Run ASD/Disk Utility to repair and test hard drive. If repair attempts fail, repartition hard drive and reinstall OS. Replace hard drive if restore fails.	H03
	No	Symptoms unchanged, go to Step 7	



7. Check for thermal values and fan running speed Run ASD to check for fan and sensors test, and verify that ASD does not report any overtemp, failing sensor, or fan.	Yes	No thermal fail detected. Replace logic board with matching symptom: - If hang or freeze - If Kernel Panic/system crashes	M05 M06
	No	If a sensor test failed in ASD, check sensor connections to logic board and retest. If still failing, replace sensor or part where it is located (trackpad, logic board, , fan, other): -If trackpad sensor failed -If logic board sensor failed -If fan test failed, replace fan.	M23 M18 X22

Battery Run Time Too Short

Quick Check

Symptom	Quick Check
Battery Run Time Too Short Battery runs out of power very quickly (less than two hours)	<ol style="list-style-type: none"> 1. Use the “Notebook Computer Battery and Adapter Screening Process for Apple Service Providers” (Knowledge Base CP165) and run the Notebook Battery and Adapter Diagnostic. 2. Verify no applications have runaway processes with the CPU. See “Runaway applications can shorten battery runtime” (Knowledge Base TS1473). 3. Use “Apple Portables: Battery Life” (Knowledge Base HT1466) to screen for short battery run time.



Won't Run on Power Adapter

Unlikely cause: RAM, display assembly, hard drive, optical drive, top case, speakers, camera, microphone

Quick Check

Symptom	Quick Check
<p>Won't Run on Power Adapter Alone</p> <p>Runs on battery but not on power adapter only.</p>	<ol style="list-style-type: none"> 1. Verify proper wattage adapter is being used. 2. Check for dirty or stuck pins on the MagSafe connectors, both on the adapter and the computer. 3. Connect the AC adapter to known-good power source. 4. Verify power cord or plug is properly attached to AC adapter and MagSafe cable is not damaged. 5. Check for dirty or stuck pins on the MagSafe connectors, both on the adapter and the computer. Use and cleaning of power adapter with MagSafe 6. Reset SMC by pressing the (left) Shift-Control-Option keys along with the power button once. 7. Run the Notebook Battery and Adapter Diagnostic with a known-good adapter.

Deep Dive

Check	Result	Action	Code
1. Reset SMC and verify that a known-good connected power adapter has the MagSafe LED light up either green or amber.	Yes	SMC on logic board senses AC power adapter. Go to step 2.	
	No	Go to step 4.	
2. Disconnect battery. Verify that a known-good power adapter starts up and run the system and show MagSafe LED status.	Yes	Go to step 3.	
	No	Go to step 4	



3. Reconnect battery. Verify that a known-good power adapter starts up and run the system and show MagSafe LED status.	Yes	Leave battery charge for some minutes. Meanwhile, run Notebook Battery and Adapter Diagnostic with unit's adapter to confirm adapter is defective and needs replacement.	P14
	No	Go to step 4.	
4. Reseat MagSafe board connection to logic board, and verify that a known-good power adapter starts up and run the system and show MagSafe LED status.	Yes	Issued resolved.	
	No	Replace MagSafe board and go to step 5.	M01
5. Verify that a known-good power adapter starts up and run the system and show MagSafe LED status.	Yes	Issued resolved.	
	No	Replace logic board	M01

Noise / Hum / Vibration

Unlikely cause: RAM, display assembly, top case, camera, microphone, battery

Quick Check

Symptom	Quick Check
Noise / Hum / Vibration Computer or AC adapter emits noise or vibration.	<ol style="list-style-type: none"> 1. Verify and reproduce the source of the noise from the computer / adapter with the customer. 2. If the AC adapter is the source of the noise disconnect and try a known-good adapter. (A small amount of hum or vibration is normal with AC adapters.)

Deep Dive

Check	Result	Action	Code
1. Use of a known-good AC adapter eliminates the noise/ vibration.	Yes	Replace AC adapter.	P04
	No	Go to step 2	



2. Plug and unplug headphones and verify that the noise is heard through the speakers and / or headphones.	Yes	Go to step 3	
	No	Go to step 4	
3. Disconnect any peripheral devices, cards, or cables attached to the unit. Verify the noise is gone.	Yes	Check for possible ground loop.	
	No	Go to step 6	
4. Locate the source of the noise. Verify that the noise comes from the optical drive operation.	Yes	Check with a different media disc. Possible issue with disc label or out of balance media. If not related to media, and noise is above normal level, reseal optical drive and retest. If issue remains, replace optical drive.	J04
	No	Go to step 5	
5. Verify that the noise is coming from the hard drive.	Yes	Identify the type/speed of installed drive. It is normal for drives to produce noise when they spin up, when the heads move or lock to their safety landing place. Replace the drive if noise is above normal levels.	H06
	No	Go to step 6	
6. Verify that the noise is coming from the fan.	Yes	The fan is generally running slowly but may accelerate when intensive processing is required (calculation, 3D gaming, or screen saver animation). If still beyond expected sound level, check for interference of fan with other mechanical element of system (foam, bracket, shield) before replacing a noisy fan.	X23
	No	Go to step 7.	



7. Noise may be related to interference from other electrical devices operating near computer, or on same AC power source. Verify if noise is gone when operating in a different location on a different AC circuit.	Yes	Perhaps operating the unit with a surge suppressor will eliminate or reduce the noise. Change location of use or limit use of other device that is inducing the noise.	
	No	Replace logic board.	M09

Burnt Smell / Odor

Unlikely cause: Enclosure

Quick Check

Symptom	Quick Check
Burnt Smell / Odor Computer or power adapter emits an odor or smell of smoke.	<ol style="list-style-type: none"> 1. Disconnect the battery and AC adapter from the computer. 2. Attempt to identify the source of the odor. Visual clues are component damaged like capacitor chip popped or burn marks.

Deep Dive

Check	Result	Action	Code
1. Verify whether the source of the odor has been identified.	Yes	Replace the affected part.	P08
	No	Go to step 2	
2. Verify whether there are any burn marks visible on components.	Yes	An improperly seated or damaged cable can blow logic board components. Make sure you identify the cause before replacing the affected part.	P08
	No	Go to step 3	
3. Refer to Liquid Submersion Indicators. Verify whether any of the submersion indicators turned red, showing that system suffered from liquid spillage.	Yes	For more information, refer to Knowledge Base article http://support.apple.com/kb/HT3400 : "About Liquid contact indicators (LCI) on portable and desktop computers.	
		Go to step 4	



4. Verify that the computer is operating normally.	Yes	This could be related to normal operation. Also check for accidental damage cause using Knowledge Base article http://support.apple.com/kb/CP161 .	
	No	Refer to best related troubleshooting section. If after inspecting the unit you feel there is a possible safety issue with the computer or AC adapter, please notify Apple.	

Battery Leaking or Swollen

Quick Check

Symptom	Quick Check
Battery Leaking or Swollen <ul style="list-style-type: none"> Trackpad button does not work Battery pack case has opened. Bottom cover cannot be reinstalled 	<ol style="list-style-type: none"> Check if the battery is covered under a repair extension program. Use the “Notebook Computer Battery and Adapter Screening Process for Apple Service Providers” (Knowledge Base CP165) and use “Battery pack is visibly deformed” case under section 2E. Use symptom code P13.

Uncategorized Symptom

Quick Check

Symptom	Quick Check
Uncategorized Symptom Unable to locate appropriate symptom code	Verify whether existing symptom code applies to the issue reported by the customer. If not, document reported symptom and send feedback to smfeedback@apple.com stating that a suitable symptom code could not be found.



Communications

Ethernet Port/Device Issue

Unlikely cause: power adapter, battery, speakers, optical drive, hard drive, fan, camera, microphone, top case, display module, AirPort card

Quick Check

Symptom	Quick Check
Ethernet Port/Device Issue <ul style="list-style-type: none"> No Ethernet device present Unable to access network resources Ethernet device shows no connection Ethernet device unable to get an IP address Slow network performance 	<ol style="list-style-type: none"> Check the network cable for damage, try a known good Ethernet cable – CAT5 or better recommended for 100Mbps+ connections. Check Ethernet ports on Mac and wall/switch for dust, debris, damage or bent pins. Also make sure that user does not insert cable upside down in the Ethernet connector. Ensure distance from networking infrastructure is less than 300 feet / 105 meters. Verify port, cable and network hardware with a known good system. Isolate firewall, MAC address filtering or hardware access control devices. Check system logs. Isolate OS by starting up from original OS install disc (10.5.x) or compatible known good OS.

Deep Dive

Check	Result	Action	Code
1. Visually inspect Ethernet connector to ensure all pins will make physical contact with CAT5 network cable.	Yes	Ethernet interface contacts are good. Go to step 2.	
	No	Pins are damaged or bent flat, replace logic board.	M10



2. Isolate OS by booting from original OS install disc. Verify Network Link status active by using Network Utility on install DVD. If the Ethernet interface (en0) Link Status is inactive, recheck physical connect and link activity indicator on hub/switch.	Yes	Ethernet interface (en0) Link Status is active, go to step 3.	
	No	If connection is OK on known-good system, replace logic board.	M10
3. Verify if IP address is listed for the Ethernet interface in System Preferences: Network. Connect computer to network with known-good DHCP IP allocation, ensuring static DHCP maps or filtering is not preventing address allocation. Note: DHCP allocation may not be instantaneous depending on network. Retest.	Yes	Go to step 4.	
	No	If connection is OK on known-good system, replace logic board.	M10
4. Verify connection by using Network Utility to ping another connected computer on the same subnet. Ensure the target computer's IP address is valid, on the same subnet and powered on. Ensure no MAC address filtering or hardware access control devices are present. Use a simple hub/switch environment.	Yes	Go to step 5	
	No	If the symptoms do not change, replace the logic board.	M10
5. Verify Ethernet performance and reliability by starting up from a known-good OS install, and downloading a large file from a web site or file server.	Yes	If there is no performance or connectivity issue isolated solely to the system under test, the problem may be the network environment. No repair is necessary.	
	No	If there are connection dropouts or poor performance not seen on a known-good test system, replace the logic board.	M10



AirPort/Bluetooth: Defective Wireless Devices

Unlikely cause: power adapter, battery, speakers, optical drive, hard drive, fan, microphone, top case



Caution: When testing an AirPort/Bluetooth card connection, wait at least 5 seconds after shutdown before touching the camera cable connection to the logic board. Waiting less than that could damage the AirPort card.

Quick Check

Symptom	Quick Check
<p>AirPort or Bluetooth: Defective Wireless Devices</p> <ul style="list-style-type: none"> • Unable to join networks or pair devices • Card not available or recognized • Intermittent device or connection dropouts 	<ol style="list-style-type: none"> 1. Open System Preferences and make sure AirPort or Bluetooth is turned on and (for AirPort) that a network is selected. 2. Check that base station is not using unsupported connection and encryption protocols. 3. Check for nearby interference sources such as microwave ovens or cordless phones (Knowledge Base HT1365) 4. Check the number of users trying to use AirPort in the area for possible network congestion. 5. Isolate OS by booting from original OS install disc (10.6.x). Attempt to connect to base station (AirPort) or pair with wireless keyboard (Bluetooth). 6. Reset PRAM.



Deep Dive

Check	Result	Action	Code
1. Open System Profiler, check to see if AirPort and Bluetooth interfaces are recognized. Ensure that available software and firmware updates for AirPort and Bluetooth have been applied.	Yes	-(AirPort) Ensure MAC address filtering is not enabled on the base station. -(Bluetooth) Ensure target devices are set to discoverable. Go to No/Poor Wireless Signal symptom table.	
	No	If card is not detected and available software updates do not resolve issue, go to step 2.	
2. Reseat both ends of the AirPort/Bluetooth flex cable connection to the logic board. Retest and verify that the AirPort and Bluetooth interfaces are now recognized in System Profiler.	Yes	Loose cable connection.	
	No	Check for damaged or bent pins in both ends of flex cable and in connectors: -If damage is found, replace cable and retest. If issue remains, go to step 3. -If no damage found, go to step 3.	X03
3. Try a known-good AirPort/Bluetooth flex cable. Verify that the AirPort and Bluetooth interfaces are now recognized in System Profiler.	Yes	Replace user's AirPort/Bluetooth flex cable.	X03
	No	Continue to use known-good cable, go to step 4.	
4. Try a known-good AirPort/Bluetooth card. Verify that the AirPort and Bluetooth interfaces are now recognized in System Profiler.	Yes	Replace user's AirPort/Bluetooth card. .	N18
	No	Replace user's logic board.	M11



No/Poor Wireless Signal

Unlikely cause: power adapter, battery, speakers, optical drive, hard drive, fan, camera, microphone, top case

Quick Check

Symptom	Quick Check
No/Poor Wireless Signal <ul style="list-style-type: none"> Unable to find networks Intermittent connection dropouts Slow transfer speeds 	<ol style="list-style-type: none"> Check for nearby interference sources in the 2.4/5GHz range such as microwave ovens and cordless phones (Knowledge Base HT1365). Check that computer is within base station range – move closer to base station. Base station checks: <ol style="list-style-type: none"> Base station is not set to low-power transmission mode Base station is not using unsupported connection and encryption protocols Check for possible Wi-Fi channel overlap (nearby base stations using adjacent channel) Isolate OS by booting from original OS install disc (10.6x). Attempt to connect to base station.

Deep Dive

Check	Result	Action	Code
1. Use Software Update to make sure all AirPort and Bluetooth software and firmware updates have been applied. Open System Profiler, and verify that both AirPort and Bluetooth devices are recognized..	Yes	Ensure base station is not using MAC address filtering or creating a hidden network. Go to step 2.	
	No	If card is not detected, go to previous Symptom - AirPort/Bluetooth - Defective wireless devices symptom table..	
2. Check that the Bluetooth and the two AirPort antennas are all connected to the AirPort/Bluetooth card.	Yes	Go to step 3	
	No	One or more of the three antennas was disconnected. Reseat and retest. If one of the antennas is damaged, replace display module and retest	L18



3. Verify that the two AirPort antennas connections to the AirPort card are not reversed.	Yes	Crossed AirPort antenna connections. Reseat them in correct order and retest.	
	No	If the connectors are secure, antenna connections not reversed and show no signs of damage or wear, go to step 4.	
4. Try a known-good AirPort/Bluetooth card, and verify that the No/Poor Wireless signal issue is fixed.	Yes	Replace user's AirPort/Bluetooth card..	N14
	No	Replace display module for failing antenna.	L16

Wireless Input Device Loses Connection

Unlikely cause: display module, speaker assembly, optical drive, hard drive

Quick Check

Symptom	Quick Check
Wireless Input Device Loses Connection	<ol style="list-style-type: none"> 1. Check Bluetooth input device has fully charged batteries. 2. With user's Bluetooth input device paired, check that all software and firmware updates have been applied.

Deep Dive

Check	Result	Action	Code
1. System Profiler should list Bluetooth device under system hardware. Is Bluetooth device available?	Yes	Bluetooth radio present, verify Bluetooth preference settings, go to step 2.	
	No	Go to AirPort/Bluetooth: Defective Wireless Devices symptom table	



2. System Preferences has a Bluetooth panel. Ensure that Bluetooth is on and discoverable, that known-good Bluetooth device is on, in close range, and in discoverable mode. Verify that device is listed in pairing window.	Yes	Choose known-good device and establish a connection. Go to step 3.	
	No	Go to step 5.	
3. Verify that computer is pairing with known-good device.	Yes	Pairing verified, connect with user's device, go to step 4	
	No	Go to step 5.	
4. Test user's Bluetooth device and verify that computer is also pairing with user's Bluetooth device.	Yes	Connection established, Continue testing with known-good Bluetooth input device for connection loss. Go to step 7.	
	No	Replace defective user's Bluetooth device if Apple and within 1-year warranty.	K08
5. Reseat Bluetooth antenna on AirPort/Bluetooth card. Is the Bluetooth radio on and pairing with a known-good device?	Yes	Loose antenna connection.	
	No	Go to step 6.	
6. Install and test with a known-good AirPort/Bluetooth card. Is the Bluetooth radio now pairing with a known-good device?	Yes	Replace defective user's AirPort/Bluetooth card.	N15
	No	Replace display module for defective antenna.	L16
7. Continue to actively test a known-good Bluetooth device to determine if there is a disconnect. Do not allow computer to sleep during this test. Verify whether link was lost during test.	Yes	Check for software update, 2.4/5 GHz radio interference or device low battery.	
	No	Known-good device passed, Test with user's Bluetooth device: go to .step 8.	
8. Continue to test user's Bluetooth device .Open Bluetooth Setup Assistant and enable "start up when no input device is present". Verify that device loses connection.	Yes	Check for 2.4/5 GHz radio interference, device low battery or user's device features list for explanation.	
	No	User's device not losing connection. Issue not repeatable or resolved.	



AirPort Card: Kernel Panic

Unlikely cause: power adapter, battery, speakers, optical drive, hard drive, fan, camera, microphone, top case

Quick Check

Symptom	Quick Check
AirPort Card: Kernel Panic <ul style="list-style-type: none"> Kernel panic on boot Kernel panic or freezing while attempting to connect to Wi-Fi networks Kernel panic while transferring data on Wi-Fi networks. 	<ol style="list-style-type: none"> Isolate OS by booting from original OS install disc (10.6x). Attempt to connect to Wi-Fi network. Using an Ethernet connection temporarily, run automatic Software Update to make sure all AirPort software and firmware updates have been applied.

Deep Dive

Check	Result	Action	Code
1. Use Software Update to make sure all AirPort/Bluetooth software and firmware updates have been applied. Ensure MAC address filtering is not enabled on the base station. Verify that kernel panic issue is resolved.	Yes	Software issue.	
	No	Go to step 2.	
2. Reseat the AirPort/Bluetooth flex cable connection to the logic board and to the card. Verify that the kernel panic is resolved	Yes	Loose cable connection.	
	No	Check for damaged or bent pins in both ends of flex cable and in connectors: -If damage is found, replace cable and retest. If issue remains, go to step 3. -If no damage found, go to step 3.	X03
3. Disconnect the AirPort/Bluetooth flex cable from the logic board, and verify that the kernel panic issue is resolved.	Yes	Go to step 4.	
	No	Go to Kernel Panic / System Crashes symptom table..	



4. Connect and test with a known-good AirPort/Bluetooth flex cable. Verify that kernel panic issue is resolved.	Yes	Replace AirPort/Bluetooth flex cable and retest..	X03
	No	Go to step 5	
5. Connect and test with a known-good AirPort/Bluetooth card. Verify that kernel panic issue is resolved.	Yes	Replace AirPort/Bluetooth card and retest.	N13
	No	Go to step 6	
6. Boot from known-good boot image of Mac OS. Verify that kernel panic issue is resolved.	Yes	Restore Mac OS	
	No	Replace logic board.	M06

Wireless Performance Issue / Slow Connection

Unlikely cause: power adapter, battery, speakers, optical drive, hard drive, fan, camera, microphone, top case

Quick Check

Symptom	Quick Check
Wireless Performance Issue / Slow Connection <ul style="list-style-type: none"> • Slow or stalled data transfers • Intermittent connection dropouts • AirPort does not work from Install disc alone 	<ol style="list-style-type: none"> 1. Check for nearby interference sources in the 2.4/5GHz range such as microwave ovens or cordless phones (Knowledge Base HT1365) 2. (AirPort) Check the number of AirPort users in the area for possible network congestion. Move closer to base station to improve signal reception. 3. (Bluetooth) Move devices closer together. 4. Check performance with a known-good system. 5. (AirPort) Wireless base station checks: <ol style="list-style-type: none"> a. Base station is not set to low-power transmission mode. b. Base station is not set to a slower protocol mode (802.11b). c. Check for possible Wi-Fi channel overlap (nearby base stations using adjacent channel). 6. Isolate OS by booting from known-good boot image on external drive. Attempt to connect to (AirPort) base station or pair with (Bluetooth) wireless keyboard. 7. Use Software Update to check all AirPort and Bluetooth software/firmware updates have been applied.



Deep Dive

Check	Result	Action	Code
1. Inspect the display clutch barrel for damage. AirPort and Bluetooth antennas are in display clutch barrel area.	Yes	Record damage: Proceed to possibly repair damaged parts, go to step 2	
	No	No visible damage, go to step 2	
2. Turn off Bluetooth. Retest AirPort performance. Refer to Knowledge Base TS1809 .	Yes	Possible AirPort interference from the Bluetooth card. Change AirPort base station channel. (Knowledge Base TS1809 .)	
	No	Continue by checking connections, go to step 3	
3. Check that the Bluetooth and AirPort antennas are connected to the AirPort/Bluetooth card..	Yes	-AirPort issue, go to step 4, -Bluetooth issue, go to step 6.	
	No	Reconnect antenna(s) and retest.	
4. (AirPort) Verify that the two antennas connections to the AirPort/Bluetooth card are not reversed or loose.	Yes	Loose connection or crossed antenna. Reseat antennas. If damage is found, replace display module for affected element: -damaged AirPort antenna assembly, -or damaged AirPort/Bluetooth card	L16 L23
	No	If the connectors are secure, antenna connections is not reversed and does not show any signs of damage or wear, go to step 5	
5. (AirPort) Try a known-good AirPort/Bluetooth card. Verify that Wireless Performance / Slow Issue issue is fixed..	Yes	Replace user's AirPort/Bluetooth card..	N14
	No	Replace user's display module for defective antenna.	L16



6. (Bluetooth) Verify that the Bluetooth antenna connection to the AirPort/Bluetooth card is not loose.	Yes	Loose connection. Reseat antenna. If damage is found, replace defective element: -replace display module for damaged Bluetooth antenna, -or replace damaged AirPort/Bluetooth card	X03 N04
	No	If the connectors are secure, and antenna connection does not show sign of damage or wear, go to step 7	
7. (Bluetooth) Enable Bluetooth and try a known-good AirPort/Bluetooth card if available. Verify that Wireless Performance /Slow Issue issue is fixed..	Yes	Replace user's AirPort/Bluetooth card..	N14
	No	Replace user's display module for defective Bluetooth antenna.	L23

Wireless Input Device Doesn't Pair

Unlikely cause: display module, logic board, optical drive, hard drive

Quick Check

Symptom	Quick Check
Wireless Input Device Doesn't Pair <ul style="list-style-type: none"> Can't get the system to recognize the Bluetooth keyboard or mouse 	<ol style="list-style-type: none"> Check Bluetooth System Preference is set to Discoverable. Check Bluetooth device has fully charged batteries. Check for Bluetooth software updates for both the device and Mac OS X. If the Bluetooth pairs with no problems, probe about potential interference issue at user's site.



Deep Dive

Check	Result	Action	Code
1. System Profiler should list Bluetooth radio device under system hardware. Verify that Bluetooth device is listed in System Profiler.	Yes	Bluetooth radio present, verify Bluetooth preference settings, go to step 2.	
	No	Go to AirPort/Bluetooth: Defective Wireless Devices symptom table	
2. System Preferences has a Bluetooth panel. Ensure Bluetooth is on and discoverable. Ensure a known-good Bluetooth device is on, in close range and discoverable mode, Verify that there is (are) device(s) listed in pairing window.	Yes	Choose known-good device and establish a connection. Go to step 3.	
	No	Attempt Bluetooth repair, go to step 5.	
3. Ensure a known-good Bluetooth device is on, in close range and discoverable mode. Is system pairing with known-good device?	Yes	Pairing verified, connect with user's device, go to step 4.	
	No	Attempt Bluetooth repair, go to step 5.	
4. Verify that Bluetooth pairing with user's Bluetooth is device?	Yes	Issue resolved.	
	No	Check for available software and firmware updates for both system and user device.	
5. Check Bluetooth antenna connection to the AirPort/Bluetooth card. Verify that system now pairs with the known-good device.	Yes	Bluetooth antenna not connected. Issue resolved.	
	No	Go to step 6.	



6. Verify that the Bluetooth antenna connection to the AirPort/Bluetooth card is not loose.	Yes	Loose connection. Reseat antenna. If damage is found, replace affected element: -replace display module for damaged Bluetooth antenna, -or replace damaged AirPort/Bluetooth card	L23 N17
	No	If the connectors are secure, and antenna connection does not show sign of damage or wear, go to step 7	
7. Install and test a known good AirPort/Bluetooth card. Verify that the Bluetooth radio is present, on and now pairing with a known-good device.	Yes	Replace AirPort/Bluetooth card..	N15
	No	Replace display module for defective Bluetooth antenna.	L23

Uncategorized Symptom

Quick Check

Symptom	Quick Check
Uncategorized Symptom Unable to locate appropriate symptom code	Verify whether existing symptom code applies to the issue reported by the user. If not, document reported symptom and send feedback to smfeedback@apple.com stating that a suitable symptom code could not be found.



Display

Display Anomalies

Quick Check

Symptom	Quick Check
Display Anomalies <ul style="list-style-type: none"> • Incorrect/missing colors • Distorted/blurred image • Pixel anomalies • Vertical/horizontal lines • Non-uniform brightness • Image flicker • Image persistence 	<ol style="list-style-type: none"> 1. Allow display to reach normal operating temperature for about 15 minutes before evaluating front-of-screen performance. 2. Check display preferences for use of custom display profile. 3. Check brightness setting. 4. Check for Software Updates. 5. Clean glass panel while checking for dust/debris 6. Check with an externally connected display.

Deep Dive: General

Check	Result	Action	Code
1. Verify if user's issue is incorrect/missing colors.	Yes	Go to Incorrect/Missing Colors Deep Dive .	
	No	Go to step 2.	
2. Verify if user's issue is distorted/blurred image.	Yes	Go to Distorted/Blurred Image Deep Dive .	
	No	Go to step 3.	
3. Verify if user's issue is bright or dark pixel anomalies.	Yes	Go to Pixel Anomalies Deep Dive .	
	No	Go to step 4.	
4. Verify if user's issue is vertical or horizontal lines.	Yes	Go to Vertical/Horizontal Lines Deep Dive .	
	No	Go to step 5.	
5. Verify if user's issue is non-uniform brightness.	Yes	Go to Non-uniform Brightness Deep Dive .	
	No	LCD functioning OK.	



Deep Dive: Incorrect/Missing Colors

Check	Result	Action	Code
1. Verify display is listed in the System Profiler's Graphics/Displays device tree.	Yes	This ensures color profile can be matched with LCD. Go to step 2.	
	No	No communication with LCD device data. Go to step 7.	
2. Verify System Preferences Display Profile is valid for display being tested. Color profile should be set to Color LCD, user may have created an off-color calibration setting.	Yes	If display profile is valid and colors are still incorrect or missing, go to step 3.	
	No	Set System Preferences: Displays: Color to Color LCD and retest.	
3. Verify that the glass panel is free of contaminants.	Yes	Go to step 4.	
	No	Clean glass panel using approved method. Retest.	
4. Inspect & verify that display cable and logic board connectors are free from any damage or bent pins.	Yes	Reseat cable and go to step 5	
	No	-If display cable connector is damaged, replace display module and retest. -If logic board connector is damaged, replace logic board and retest.	L18 M24
5. After cable has been inspected run Clamshell Service Diagnostic utility and check for LCD panel presence. If not found, reseat cable and verify that missing colors have been restored.	Yes	Loose cable connection. Issue resolved.	
	No	Go to step 6.	
6. Set desktop pattern in System Preferences to 'Solid Gray Light'. Verify if incorrect/missing color issue affects entire display.	Yes	Test needed with known-good display, go to step 8	
	No	Go to step 7.	
7. Set up display under test side by side with another known good display showing the same image. Verify if issue is noticeably worse on the display being tested.	Yes	Test needed with known-good display, go to step 8	
	No	Small variations in color uniformity are normal and do not warrant replacement or repair of the display.	



8. Substitute a known-good display module to test logic board video output. Verify that normal video is restored.	Yes	Replace display module.	L02
	No	Replace logic board.	M04

Deep Dive: Distorted/Blurred Image



Check	Result	Action	Code
1. Sample image illustrates loss of display data signals to LCD or a defective LCD panel. Inspect & verify that display cable and logic board connectors are free from any damage or bent pins.	Yes	Reseat cable and go to step 2	
	No	-If display cable connector is damaged, replace display module and retest. -If logic board connector is damaged, replace logic board and retest.	L18 M24
2. After cable has been inspected and reseated, verify that normal video is restored.	Yes	Issue was due to loose connection. Display issue resolved.	
	No	Go to step 3..	
3. Substitute a known good display module to test logic board internal video output. Verify that normal video is restored.	Yes	Replace display module.	L04
	No	Replace logic board.	M04

Deep Dive: Pixel Anomalies

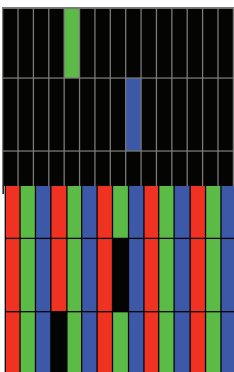

Check	Result	Action	Code
1. Determine if “defects” are dust/ debris on surface of glass panel.	Yes	Clean glass panel.	
	No	Go to step 2.	
2. Determine if bright pixel defects exceed the acceptable number. See Display Issue: Pixel Anomalies .	Yes	Replace display module.	L08
	No	LCD meets bright pixel defect specifications. Go to step 3.	
3. Determine if dark pixel defects exceed the acceptable number. See Display Issue: Pixel Anomalies .	Yes	Replace display module.	L08
	No	LCD meets dark pixel defect specifications. Go to step 4.	



Check	Result	Action	Code
4. Determine if the combination of bright/dark pixel defects exceed the acceptable number. See Display Issue: Pixel Anomalies .	Yes	Replace display module.	L08
	No	Explain to user that LCD is within specifications. Do not replace display module.	

Deep Dive: Vertical/Horizontal Lines

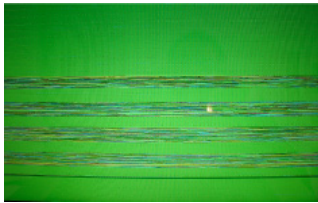

Check	Result	Action	Code
1. Horizontal lines may be related to a failing RAM module. Verify if video issue only happens AFTER the Apple logo and the spinning wheel has appeared.	Yes	Issue only happens AFTER Apple logo and spinning wheel appears. Go to step 2.	
	No	Issue happens since startup. Go to step 5.	
2. Start with shift key down (safe mode) to disable system extensions. Verify if issue still happens when booting in safe mode.	Yes	Go to step 5.	
	No	No video issue when booting in safe mode. Go to step 3.	
3. Isolate with only one memory module installed, then with the other one. Test with known-good memory. Verify that issue only happens with specific RAM module(s).	Yes	Replace affected RAM module.	X02
	No	Go to step 4	
4. Isolate with one known-good memory module installed in one of the memory slots. Repeat by testing in the other memory slot with known-good memory. Verify that issue only happens with specific memory slot on logic board.	Yes	Replace logic board.	M07
	No	Go to step 5	
5. Inspect & verify that display cable and logic board connectors are free from any damage or bent pins.	Yes	Reseat cable and go to step 6	
	No	-If display cable connector is damaged, replace display module and retest. -If logic board connector is damaged, replace logic board and retest.	L18 M24



6. After cable has been inspected run Clamshell Service Diagnostic utility and check for LCD panel presence. If not found, reseal, verify that normal video is restored.	Yes	Issue resolved by reseating loose display cable..	
	No	Go to step 7	
7. Connect external compatible DisplayPort display (or DisplayPort adapter and display). Verify if correct video appears on external display.	Yes	Go to step 8	
	No	Replace logic board	M04
8. Substitute a known-good display module to test internal logic board video output. Verify that normal video is restored.	Yes	If it was not replaced earlier, Replace display module.	L05
	No	Replace logic board.	M04

Deep Dive: Non-Uniform Brightness

Check	Result	Action	Code
1. Determine if brightness uniformity issue is visible after display has warmed up for 15 minutes.	Yes	Go to step 2.	
	No	Display backlight can take several minutes to stabilize.	
2. Inspect & verify that display cable and logic board connectors are free from any damage or bent pins.	Yes	Reseat cable and go to step 3	
	No	-If display cable connector is damaged, replace display module and retest. -If logic board connector is damaged, replace logic board and retest.	L18 M24
3. After cable has been inspected and reseated verify that an even brightness uniformity is restored.	Yes	Loose LED backlight return lines connection. Issue fixed by reseating display cable connection.	
	No	Got to step 4	
4. Determine if variation in uniformity appears excessive when compared to another similar unit.	Yes	If it was not replaced earlier, Replace display module.	L07
	No	Explain to user that LCD appears to meet specifications.	





Defective Camera / Built-in iSight Not Operating Correctly

Quick Check

Symptom	Quick Check
Defective Camera <ul style="list-style-type: none"> • Camera not detected • No green LED for camera • Excessive blooming • Poor white balance • Poor focus • Green image • Image distortion 	<ol style="list-style-type: none"> 1. Check for Software Updates. 2. Verify camera lens and glass panel are clear of contaminants.

Deep Dive

Check	Result	Action	Code
1. Launch System Profiler and confirm that "Built-in iSight" is listed under USB High-Speed Bus.	Yes	Camera recognized. Go to step 3	
	No	Go to step 2.	
2. Run Clamshell Service Diagnostic utility and check for all devices presence. If not found, inspect & verify that display cable and logic board connectors are free from any damage or bent pins.	Yes	Reseat LVDS cable and go to step 3	
	No	-If display cable connector is damaged, replace display module and retest. -If logic board connector is damaged, replace logic board and retest.	L18 M24
3. After cable was reseated, verify that the iSight is listed in System Profiler.	Yes	Camera recognized. Go to step 4.	
	No	Go to step 5	
4. Launch PhotoBooth. Verify that green camera LED is turning on and image appears normal.	Yes	Issue resolved..	
	No	Go to step 5.	
5. Substitute a known-good display module to test logic board to camera connection, and verify that iSight camera is operating properly.	Yes	Replace display module.	L17
	No	Replace logic board.	M13



Blank / No Video

Unlikely cause: Power adapter, speakers, optical drive, hard drive, fan, microphone, top case

Quick Check

Symptom	Quick Check
Blank / No Video <ul style="list-style-type: none"> No video No backlight Gray screen at startup (trackpad disconnected) 	<ol style="list-style-type: none"> Check brightness setting Attach known-good supported external display. Boot from Mac OS X install disc that came with computer. Ensure trackpad cable is connected to prevent a gray screen at startup. Check trackpad connection to logic board rather than assuming the logic board or display module is at fault.

Deep Dive

Check	Result	Action	Code
1. Verify that boot chime is present when system restarts. Reset SMC and clear PRAM if necessary for proper start up. Verify that LCD video is present.	Yes	Go to step 3.	
	No	Go to step 2.	
2. Check that trackpad cable is well seated before startup. Otherwise system could start up with gray screen.	Yes	Go to step 3.	
	No	Connect trackpad, reboot to verify issue resolved. Go to step 1.	
3. Connect known-good supported external display. Verify whether image appears on external display when system is booted.	Yes	External display detected by system. Go to step 4.	
	No	Go to No Video symptom code flow.	
4. Verify if LCD backlight is on by looking for faint glow from display when viewed in darkened room with brightness adjusted to full.	Yes	Video signal from system to external video is OK, LCD backlight is on. Go to step 6.	
	No	Go to step 5.	



5. Shine bright (low heat) flashlight into the front of LCD. Verify if an image is being displayed.	Yes	Image present but backlight is not on. Check logic board connections. Go to step 6.	
	No	Go to No Video symptom.	
6. Inspect & verify that display cable and logic board connectors are free from any damage or bent pins.	Yes	Reseat cable and go to step 7.	
	No	-If display cable connector is damaged, replace display module and retest. -If logic board connector is damaged, replace logic board and retest.	L18 M24
7. Run Clamshell Service Diagnostic utility ,check for all devices presence. If missing, reseat cable and verify that image is restored.	Yes	Loose display cable connection. Issue resolved.	
	No	Test needed with known-good display module. Go to step 8.	
8. Substitute a known-good display module and verify that internal display connector works with a known-good display module.	Yes	If it was not replaced earlier, Replace display module.	L03
	No	Replace logic board	M03

Backlight Issue / No Backlight

Unlikely cause: Power adapter, battery, speaker, optical drive, hard drive, fan microphone, top case

Quick Check

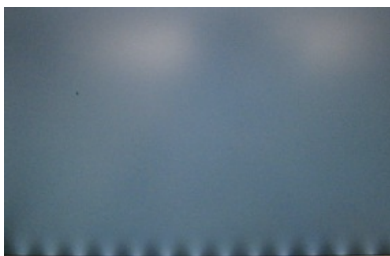

Symptom	Quick Check
Backlight Issue / No Backlight <ul style="list-style-type: none"> • Display not illuminated • Flashing, unstable or non uniform background lighting • Poor backlight at some or all settings 	<ul style="list-style-type: none"> • Check that brightness setting is above minimum. • Reset SMC. • Reset LED backlight controller by pressing Control Shift Eject keys, then wake up system back by pressing any keyboard key.



Deep Dive

Check	Result	Action	Code
1. Characterize the symptom to “no backlight” or “backlight present but with quality/ uniformity issue”. Reset LED backlight controller by pressing Control Shift Eject keys and confirm backlight presence.	Yes	Backlight controller reset solved the issue. If backlight is enabled but still with issue: Go to step 4	
	No	No Backlight: Go to step 2.	
2. Shine bright (low heat) flashlight into the front of LCD. Verify if an image is being displayed.	Yes	Image present but Backlight is not on. Check display cable connections. Go to step 3	
	No	Go to step 3.	
3. Darken room and verify backlight by detecting if any glow is emitted from the display	Yes	Backlight is operating but there is no video. Go to No Video symptom table.	
	No	Go to step 4	
4. Inspect & verify that display cable and logic board connectors are free from any damage or bent pins.	Yes	Go to step 5	
	No	-If display cable connector is damaged, replace display module and retest. -If logic board connector is damaged, replace logic board and retest.	L18 M24
5. Run Clamshell Service Diagnostic utility and check for all devices presence. If not found, reseat cable and verify that backlight is restored.	Yes	Loose display cable connection. Issue resolved.	
	No	Go to step 6.	
6. Substitute a known-good display module to test logic board internal video output. Verify that normal backlight is restored.	Yes	If it was not replaced earlier, replace display module.	L09
	No	Backlight fuse may have been blown. Remove rear vent and check fuse (see good fuse on left). If blown, replace logic board.	M25

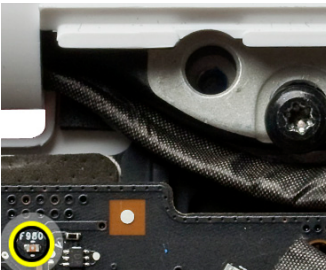



Noise / Unstable Flickering

Unlikely cause: Top case, battery

Quick Check

Symptom	Quick Check
Noise / Unstable Flickering <ul style="list-style-type: none"> Image flicker Audible noise 	1. Verify known-good source sound file not causing speaker distortion.

Deep Dive

Check	Result	Action	Code
1. Verify if user's issue is due to video flickering coming from display.	Yes	Suspected flickering issue, go to step 2.	
	No	Audible noise issue, go to step 6.	
2. Verify display listed in the System Profiler's Graphics/Displays device tree is not disappearing intermittently (refresh System Profiler to observe).	Yes	Power and LCD panel ID are OK. Go to step 3.	
	No	Go to No Video symptom code flow.	
3. Inspect & verify that display cable and logic board connectors are free from any damage or bent pins.	Yes	Reseat cable and go to step 4	
	No	-If display cable connector is damaged, replace display module and retest. -If logic board connector is damaged, replace logic board and retest.	L18 M24
4. After cable has been inspected and reseated, verify that backlight flickering issue is fixed.	Yes	Loose display cable connection. Issue resolved.	
	No	Go to step 5..	
5. Substitute a known good display module to test logic board backlight output. Verify that flickering has stopped.	Yes	If it was not replaced earlier, Replace display module.	L06
	No	Replace logic board.	M25



6. Verify the source of the noise is the electrical as opposed to mechanical. Audio noise should not be a concern now that LCD components are all solid state devices including LED backlights.	Yes	Noises that are not audible from the normal user position are considered acceptable. Return unit to the user.	
	No	Noise from another source. Go to Noise/Hum/vibration symptom table..	

Mechanical/Physical Damage

Quick Check

Symptom	Quick Check
Mechanical/Physical Damage <ul style="list-style-type: none"> • Broken glass • Broken hinge • Stripped screw/head • Stripped screw boss • Dent or scratch to chassis 	<ol style="list-style-type: none"> 1. Determine damage caused by user/technician environment, accidental damage, or abuse. 2. Inform user/technician that failures/defects of this kind are not covered by Apple warranties. Refer to http://www.apple.com/legal/warranty

Cosmetic Defects

Quick Check

Symptom	Quick Check
Cosmetic Defects <ul style="list-style-type: none"> • Cracked LCD • Scorched or melted LCD • LCD impact damage 	<ol style="list-style-type: none"> 1. Determine damage caused by user/technician environment, accidental damage, or abuse. 2. Inform user/technician that failures/defects of this kind are not covered by Apple warranties. Refer to http://www.apple.com/legal/warranty



Uncategorized Symptom

Quick Check

Symptom	Quick Check
Uncategorized Symptom Unable to locate appropriate symptom code	Verify whether existing symptom code applies to the issue reported by the user. If not, document reported symptom and send feedback to smfeedback@apple.com stating that a suitable symptom code could not be found.



Mass Storage

Hard Drive Read/Write Issue

Unlikely cause: LCD, speakers, fan, camera, microphone

Quick Check

Symptom	Quick Check
Hard Drive Read/Write Issue Bad Sector/Defective Drive Formatting Issue <ul style="list-style-type: none"> • Cannot save documents • Read/Write error message • Hang when accessing or saving data 	<ol style="list-style-type: none"> 1. Boot from Install DVD. Verify S.M.A.R.T. status of drive using Disk Utility. 2. Repair disk using Disk Utility. 3. Erase disk and reinstall Mac OS using Installer.

Deep Dive

Check	Result	Action	Code
1. Start up from Restore DVD and launch Disk Utility. Is hard drive available for Disk Utility to repair?	Yes	Go to step 2.	
	No	Go to step 3.	
2. Did Disk Utility mount and repair hard drive successfully? Reseat hard drive if necessary.	Yes	Restart computer. Go to step 6.	
	No	If computer has not been verified with a known-good hard drive, go to step 3; otherwise, go to step 7.	
3. Substitute a known-good bootable hard drive, does system start up to desktop?	Yes	Reinstall unit's drive, go to step 2.	
	No	Continue to use known-good bootable hard drive to determine root cause. Go to step 4.	



4. After reseating hard drive SATA and logic board connections, does known-good hard drive boot to desktop?	Yes	Reinstall unit's drive, go to step 2	
	No	Suspect hard drive SATA cable, go to step 5.	
5. Replace hard drive SATA cable and retest with known-good hard drive.	Yes	Reinstall unit's drive, go to step 2.	
	No	Replace logic board.	M19
6. Did unit's hard drive start up successfully?	Yes	Issue resolved.	
	No	Restore hard drive image; go to step 7.	
7. Partition, erase & install Mac OS on unit's hard drive. Did install complete without error and start up successfully?	Yes	Issue resolved	
	No	Hard drive appears to be defective, go to step 8.	
8. Replace unit's hard drive. Does drive format correctly with a GUID partition map and install Mac OS without errors?	Yes	Hard drive replaced. Issue resolved.	H01
	No	SATA cable verified or replaced and new hard drive installed, replace logic board.	M19

Hard Drive Not Recognized/Not Mounting

Unlikely cause: LCD, speakers, fan, camera, microphone, AirPort

Quick Check

Symptom	Quick Check
Hard Drive Not Recognized/Not Mounting or Booting <ul style="list-style-type: none"> Flashing question mark Boots to grey screen Boots to blue screen 	<ol style="list-style-type: none"> Use a known-good mouse. Stuck mouse button will not allow boot. Boot from Install DVD. Verify S.M.A.R.T. status of drive using Disk Utility. Repair disk using Disk Utility. Erase disk and reinstall Mac OS using Installer.



Deep Dive

Check	Result	Action	Code
1. Boot from Restore DVD and launch Disk Utility. Verify that hard drive is available in Disk Utility to repair?	Yes	Go to step 2.	
	No	Go to step 3.	
2. Verify that Disk Utility mounted and repaired hard drive successfully. Reseat hard drive cable if necessary.	Yes	Restart computer, go to step 6.	
	No	If computer has not been verified with a known-good hard drive, go to step 3; otherwise, go to step 7.	
3. Substitute a known-good bootable hard drive, and verify that computer starts up to desktop.	Yes	Install user drive, go to step 2.	
	No	Continue to use known-good bootable hard drive to determine root cause. Go to step 4.	
4. After reseating SATA and logic board cable connections, verify that computer starts up to desktop with installed known-good hard drive.	Yes	Install user's drive, go to step 2.	
	No	Suspect hard drive SATA cable, go to step 5.	
5. Replace hard drive SATA cable and retest with known-good hard drive.	Yes	Cable replaced. Install user drive, go to step 2.	X03
	No	Replace logic board.	M19
6. Verify that unit's hard drive successfully starts up computer.	Yes	Issue resolved.	
	No	Restore unit's hard drive, go to step 7.	
7. Partition, erase & install Mac OS on unit's hard drive. Verify that install completed without error and that computer starts up successfully	Yes	Issue resolved.	
	No	Hard drive appears to be defective. Go to step 8.	
8. Replace unit's hard drive. Verify that replacement drive formats correctly with a GUID partition map and installs Mac OS without errors.	Yes	Issue resolved.	H01
	No	SATA cable verified or replaced and new hard drive installed,; replace logic board.	M19



Hard Drive Noisy

Unlikely cause: LCD, speakers, fan, camera, microphone

Quick Check

Symptom	Quick Check
Hard Drive Noisy <ul style="list-style-type: none"> Noise during start up Noise during operation Noise when drive is copying or saving data 	<ol style="list-style-type: none"> Start up from Install DVD. Verify S.M.A.R.T. status of hard drive using Disk Utility. Repair disk using Disk Utility. Check for reported noise and compare with Knowledge Base article "Apple Portables: Hard Drives and Noise" http://support.apple.com/kb/TS2354

Deep Dive

Check	Result	Action	Code
1. Boot from Restore DVD and launch Disk Utility. Verify that hard drive is available in Disk Utility to repair.	Yes	Go to step 2.	
	No	Go to Hard Drive Not Recognized/Not Mounting.	
2. Repair disk using Disk Utility and verify that it completes successfully.	Yes	Restart computer. Go to step 3.	
	No	Go to step 4.	
3. Verify that hard drive is still noisy.	Yes	Remove hard drive and start up from external drive to test fan noise. Go to step 6.	
	No	Issue resolved.	
4. Erase disk and reinstall Mac OS using Installer. Verify that process was completed.	Yes	Restart computer. Go to step 3.	
	No	Replace hard drive. Go to step 5.	H06



5. After installing new hard drive, verify that you still hear an abnormal noise.	Yes	Remove hard drive and start up from external drive to test fan noise. Go to step 6.	
	No	Issue resolved.	
6. After removing hard drive, verify if the system is still noisy.	Yes	Fan noise or optical drive noise likely to be the cause. See ODD Noisy table and Fan failures/Thermal issues table.	
	No	Go to step 7.	
7. Install a known-good hard drive and verify if the noise level is similar to unit's hard drive.	Yes	Hard drive noise level is similar to a known-good drive and does not require replacement.	
	No	Replace hard drive. Go to step 5.	H06

Optical Drive Won't Accept/Reject Media

Unlikely cause: LCD, speakers, fan, camera, microphone

Quick Check

Symptom	Quick Check
Optical Drive Won't Accept/Reject Media <ul style="list-style-type: none"> Cannot insert a disc into the drive Cannot eject a disc placed into the drive 	<ol style="list-style-type: none"> Use Apple System Profiler SATA section to see if the optical drive appears. If not, see Optical Drive Not Recognized symptom table. Restart computer and hold down mouse button or keyboard eject key to cycle optical drive. Inspect optical drive slot for obstructions



Deep Dive

Check	Result	Action	Code
1. Verify that optical drive is listed in the device tree for serial-ATA devices in System Profiler.	Yes	Optical drive has power, inspect disc acceptance. Go to step 5.	
	No	Inspect hardware. Go to step 2	
2. Verify all connections between logic board, flex cable, and optical drive are secure. Visually inspect cables and connectors for any debris, damage, or bent pins and reseal connections. Verify that optical drive is now listed in System Profiler.	Yes	Optical drive has power, inspect disc acceptance. Go to step 5.	
	No	Replace any damaged cables and retest. If connections are good and with no visible cable damage, go to step 3.	X03
3. Disconnect optical drive from logic board and connect a known-good optical drive and cable. Verify that optical drive is now listed in System Profiler.	Yes	SATA port functional, reconnect unit's optical drive with known-good SATA cable. Go to step 4.	
	No	Replace logic board.	M19
4. Install and test unit's optical drive with replacement SATA flex cable. Verify that optical drive is now listed in System Profiler.	Yes	Changing cable resolved issue. Replace optical drive cable.	X03
	No	Replace optical drive. (If Mechanical damage found on optical drive, use symptom code J05)	J03 (J05)
5. Inspect optical drive slot for disc insert/eject. Verify that there is clearance for disc use.	Yes	Go to step 6.	
	No	Replace damaged optical drive or top case if it interferes with disc use.	J01 X13
6. Insert known-good disc and test optical drive for acceptance of disc. Verify if disc auto-ejects without being recognized by Mac OS X.	Yes	Replace the optical drive. (If Mechanical damage is found on optical drive, use different symptom code)	J03 (J06)
	No	Go to step 7.	



7. Verify that disc mounts to desktop.	Yes	Go to Eject Test step 8.	
	No	Go to Optical Drive Read/Write Data Error troubleshooting page.	
8. Verify that disc is ejected properly from optical drive.	Yes	Issue resolved.	
	No	Remove optical drive and test it with ejection slot above top case edge, to locate the cause of non-ejection: -If due to drive, replace optical drive. -If due to top case, reseal drive and retest. If issue remains, replace top case if it interferes with disc ejection.	J02 X13

Optical Drive Read/Write Data Error

Unlikely cause: LCD, speakers, fan, camera, microphone

Quick Check

Symptom	Quick Check
Optical Drive Read/Write Data Error <ul style="list-style-type: none"> Errors when writing optical media. Errors when reading optical media. Hang when accessing or preparing to write data. 	<ol style="list-style-type: none"> Test user's optical media disc in a known-good drive of a similar computer to rule out disc issue. Check with known-good discs like the Install discs that came with the computer. For write issues, check with known-good media that performs well in another computer and optical drive of the same type. Check both CD and DVD media. If only one type of media is producing errors, there is a laser pickup related issue.



Deep Dive

Check	Result	Action	Code
1. Verify that media is free to spin without optical drive scraping edge or surface of media.	Yes	Go to step 2.	
	No	Replace optical drive.	J03
2. Verify that optical drive can read both CD and DVD known-good media?	Yes	Go to step 6	
	No	Computer only reading CDs, or only reading DVD indicates a laser pickup issue: replace optical drive.	J03
		Optical drive cannot read any media reliably, go to step 3.	
3. Reseat cable connections at logic board and optical drive. Verify that media is now recognized and reads reliably.	Yes	Reseating cable resolved issue.	
	No	Go to step 4.	
4. Disconnect optical drive from logic board and connect a known-good optical drive and cable. Verify that media is now recognized and reads reliably.	Yes	SATA port functional, reconnect optical drive with known-good SATA cable. Go to step 5.	
	No	Replace logic board.	M19
5. Test optical drive with known-good SATA flex cable. Verify that media is now recognized and reads/writes reliably.	Yes	Cable change resolved issue. Replace optical drive cable..	X03
	No	Replace the optical drive. (If Mechanical damage is found on optical drive, use symptom code J05)	J03 (J05)



Optical Drive Not Recognized/Device Not Mounting

Unlikely cause: LCD, speakers, fan, camera, microphone

Quick Check

Symptom	Quick Check
Optical Drive Not Recognized/ Mount <ul style="list-style-type: none"> Discs inject and eject, but do not appear in Finder 	<ol style="list-style-type: none"> Use Apple System Profiler ATA section to see if the optical drive appears. Serial-ATA section of Apple System Profiler will show any media inserted. Check Finder Preferences: General and make sure "CD's, DVD's and iPods" is checked under "Show these items on the Desktop." Check both CD and DVD media. If only one type of media is recognized, there might be a laser pickup related issue.

Deep Dive

Check	Result	Action	Code
1. Is optical drive listed in the device tree for SATA devices in System Profiler?	Yes	Issue resolved.	
	No	Go to step 2.	
2. Verify all connections between logic board, flex cable, optical drive are secure. Visually inspect cables and connectors for any debris, damage, or bent pins and reseal cable. Verify that optical drive is now listed in System Profiler	Yes	Issue resolved.	
	No	Replace any damaged cables and retest. If connections are good and with no visible cable damage, go to step 3.	X03
3. Disconnect optical drive from logic board and connect a known-good optical drive. Verify that optical drive is now listed in System Profiler.	Yes	SATA port functional, reconnect user's optical drive & SATA cable. Go to step 4.	
	No	Replace logic board.	M19



4. Install and test with replacement optical drive SATA flex cable. Verify that optical drive now is listed in System Profiler.	Yes	Cable change resolved issue	X03
	No	Replace the optical drive. (If mechanical damage is found on optical drive, use symptom code J05)	J03 (J05)

Optical Drive Noisy

Unlikely cause: LCD, speakers, fan, camera, microphone

Quick Check

Symptom	Quick Check
Optical Drive Noisy <ul style="list-style-type: none"> Noise during boot Noise during operation Noise when drive is copying or writing data 	<ol style="list-style-type: none"> Test user's optical media disc in a known-good drive of a similar computer to rule out disc issue. Check with known-good discs. Install discs that came with the computer. Check if any software or firmware update is available for this model of computer. Check to see if noise occurs without media in the drive. If so, check for hard drive (H06) and fan (M18) caused noise.

Deep Dive

Check	Result	Action	Code
1. Verify if optical drive constantly seeking or cycling eject mechanism without an optical disc installed. Optical drive should perform only one reset sequence and rest idle, ready for media.	Yes	Continue and verify with media, go to step 2.	
	No	Replace optical drive if continuous activity occurs with no disc installed.	J04
2. Insert known good data disc. Verify that media is free to spin without scraping edge or surface of media. Verify disc does not exceed maximum thickness specification.	Yes	Continue and verify with media, go to step 3.	
	No	Internal mechanical interference is affecting rotational spin of media, replace optical drive.	J04



3. Initial disc handling noise is normal. Disc spinning and head seek indicate disc is mounting to desktop. Seek noise should settle down once mounted. Verify that noise is above normal and related to seek activity.	Yes	Replace optical drive.	J04
	No	Seek noise normal. Go to step 4.	
4. Disc spin should cease 30 seconds after mounting data disc on OS desktop. Verify that the noise is related to disc spin.	Yes	Go to step 5.	
	No	Go to step 6.	
5. Remove the optical drive and check for the correct seating of the brackets on the optical drive and in the top case. Reinstall drive in unit and retest. Verify if drive is still noisy.	Yes	Go to step 6.	
	No	Issue resolved. Optical drive was not properly mounted in enclosure. (Possible physical damage to optical drive.)	(J05)
6. Eject known good data disc. Disc handling noise should be one pop of disc from motor hub and a motor gear sound driving disc out of optical drive. Verify that noise above normal and related to disc eject activity or multiple eject attempts.	Yes	Replace optical drive.	J02
	No	Go to step 7.	
7. Disc spin should cease 30 seconds after mounting data disc on desktop. Media may be mounting on a defective internal spindle hub. Verify that the noise is related to disc spin.	Yes	Replace optical drive.	J04
	No	Noise does not appear to be related to optical drive.	



Optical Drive Not Performing to Specs

Unlikely cause: LCD, speakers, fan, camera, microphone

Quick Check

Symptom	Quick Check
<p>Optical Drive Not Performing to Specs</p> <p>Read or write speeds slower than expected.</p>	<ol style="list-style-type: none"> 1. Test user's optical media disc in a known-good drive of a similar computer to rule out disc issue. 2. Check with known-good discs—Install discs that came with the computer. 3. For disc write issues, check with known-good media that performs well in another computer and drive of the same type 4. Check if any software or firmware update is available for this model of computer. 5. Check both CD and DVD media. If only one type of media is producing errors, there might be a laser pickup related issue.

Deep Dive

Check	Result	Action	Code
1. Verify that optical drive can read known-good CD and DVD media.	Yes	Go to step 5	
	No	Computer only reading CDs, or only reading DVD indicates a laser pickup issue: replace optical drive.	J03
		Optical drive cannot read any media reliably. Go to step 2.	
2. Reseat cable connections at logic board and optical drive. Verify that media is now recognized and reads reliably.	Yes	Reseating cable resolved issue.	
	No	Go to step 3.	
3. Disconnect optical drive from logic board and connect a known-good drive and cable. Verify that media is now recognized and reads reliably.	Yes	SATA port functional, reconnect unit's optical drive with known-good SATA cable. Go to step 4.	
	No	Replace logic board.	M19



4. Test unit's optical drive with replacement SATA flex cable. Verify that media is now recognized ,reads/writes reliably and performs to specs..	Yes	Cable change resolved issue. Replace unit's cable..	X03
	No	Replace optical drive. (If Mechanical damage found on optical drive, use symptom code J05)	J03 (J05)

Uncategorized Symptom

Quick Check

Symptom	Quick Check
Uncategorized Symptom Unable to locate appropriate symptom code	Verify whether existing symptom code applies to the issue reported by the user. If not, document reported symptom and send feedback to smfeedback@apple.com stating that a suitable symptom code could not be found.



Input/Output Devices

USB Port Does Not Recognize Known Input Devices

Unlikely cause: LCD, hard drive, optical drive

Quick Check

Symptom	Quick Check
USB Port Does Not Recognize Known Devices USB-wired keyboard/mouse or USB flash drive not recognized	<ol style="list-style-type: none"> 1. Check for latest software and firmware updates available for computer. 2. Use Apple System Profiler to verify the computer recognizes the USB bus. 3. Test USB port with known good Apple keyboard or mouse. 4. Verify any USB hubs have sufficient power.

Deep Dive

Check	Result	Action	Code
1. Reset SMC and clear PRAM. Verify that USB device is correctly recognized.	Yes	Issue resolved.	
	No	Go to step 2.	
2. Verify that a known-good connected USB device is receiving power from USB port. Note: first device to draw more than 500mA will get up to 1000mA, all others will still be limited to 500mA.	Yes	Go to step 3.	
	No	Replace logic board.	M15
3. Verify that unit's USB device is working on a known-good computer.	Yes	Go to step 4.	
	No	Contact USB device manufacturer for support/service.	
4. Verify that the latest Mac-compatible USB software driver is installed for this USB device.	Yes	Replace logic board.	M15
	No	Obtain an up to date Mac-compatible USB driver for the device.	



Built-in Keyboard Does Not Work Properly

Unlikely cause: LCD, hard drive, optical drive

Quick Check

Symptom	Quick Check
Built-in Keyboard Does Not Work Properly <ul style="list-style-type: none"> Keystrokes not recognized Locks up Displayed characters don't match 	<ol style="list-style-type: none"> In System Preferences: International: Input Menu, enable Keyboard Viewer. Select Show Keyboard Viewer from the Input Menu in the menu bar. Test the keyboard. Confirm correct keyboard layout is selected. Update to the latest system software/firmware. Press Caps Lock. If Caps Lock light turns on, this confirms a partial connection to the logic board.

Deep Dive

Check	Result	Action	Code
1. If specific keys are not working, check if they are physically broken.	Yes	Repair defective key if possible or replace top case; retest all keys.	K16
	No	Go to step 2.	
2. Reseat trackpad and keyboard flex cable to logic board. Verify that all keys are functional.	Yes	Issue resolved.	
	No	Go to step 3.	
3. Disconnect and verify that keyboard flex cable is in good condition (no delamination or torn cable end, no missing or cracked tracks).	Yes	Go to step 4.	
	No	Replace top case. Go to step 5.	K01
4. Reseat cable and check that flex cable end is fully inserted and aligned with connector on logic board, and that connector lock is closed. Verify that keyboard functions properly. Reseat cable; verify with ASD that all keys are functional.	Yes	Issue resolved.	
	No	Replace top case. Go to step 5.	K01
5. Verify that all keys are functional using ASD.	Yes	Issue resolved.	
	No	Replace logic board.	M15



Specific Keys Don't Work

Unlikely cause: power adapter, battery, speakers, LCD, optical drive, hard drive, fan, microphone

Quick Check

Symptom	Quick Check
Specific Keys Don't Work <ul style="list-style-type: none">• Keycap broken• Key switch broken• Sticky key• Key pressed not recognized	<ol style="list-style-type: none">1. Determine if damage caused by user/technician environment, accidental damage, or abuse.2. Inform user/technician that failures/defects of this kind are not covered by Apple warranties. Refer to http://www.apple.com/legal/warranty3. Inspect keycap and remove any trapped debris.4. If the keycap is loose, check if clasp is still intact and reattach it.5. Keycap replacement if possible; otherwise, repair is a top case replacement. Use the following symptom code:<ul style="list-style-type: none">- Inoperative keys (K01)- Sticky keys (K05).

Built-in Keyboard Is Not Recognized

Unlikely cause: LCD, hard drive, optical drive

Quick Check

Symptom	Quick Check
Built-in Keyboard Is Not Recognized <ul style="list-style-type: none">• Keystrokes not recognized	<ol style="list-style-type: none">1. Reset SMC.2. Press Caps Lock. If Caps Lock light turns on, this confirms a partial connection to the logic board.3. In System Preferences: International: Input Menu, enable Keyboard Viewer. Select Show Keyboard Viewer from the Input Menu in the menu bar. Test the keyboard.



Deep Dive

Check	Result	Action	Code
1. Verify that you see “Apple Internal Keyboard/Trackpad” listed under USB hardware devices of Apple System Profiler.	Yes	Go to step 3.	
	No	Go to step 2.	
2. Reset SMC and verify if Apple Internal Keyboard/Trackpad is now seen in the USB devices list of Apple System Profiler.	Yes	Go to step 3.	
	No	Replace logic board.	M15
3. Disconnect and verify that keyboard flex cable is in good condition (no delamination or torn cable end, no missing or cracked tracks).	Yes	Go to step 4.	
	No	If damage is found replace top case. Go to step 5.	K16
4. Reseat cable and check that flex cable end is fully inserted and aligned with connector on logic board, and that connector lock is closed. Verify that keyboard now functions properly.	Yes	Issue resolved.	
	No	Replace top case. Check LSI sensors on user’s top case, and use following codes: - keyboard not recognized; LSI not triggered - keyboard not recognized: LSI triggered. Go to step 5.	K11 K11 K90
5. Verify that all keys are functional using ASD.	Yes	Issue resolved.	
	No	Replace logic board.	M15



Built-in Trackpad Does Not Track Properly

Unlikely cause: LCD, hard drive, optical drive

Quick Check

Symptom	Quick Check
Built-in Trackpad Does Not Track Properly <ul style="list-style-type: none"> Cursor movement is random, uneven, or jumpy. Cursor hangs or stalls along path. 	<ol style="list-style-type: none"> Check for environmental factors such as humidity, hand lotion or jewelry. Check if user is touching the trackpad simultaneously with both hands. Clean the trackpad surface (with the computer off) using a clean, dry, lint free cloth. Apply hand palm onto the full surface of trackpad to reset it. Make sure all software and firmware updates have been applied. If the issue occurs when system is running from the power adapter, use a grounded power cord with the power adapter.

Deep Dive

Check	Result	Action	Code
1. Verify that you see the trackpad continuously listed under USB in Apple System Profiler.	Yes	Trackpad communicating to system. Go to step 5.	
	No	Go to step 2	
2. Verify whether the trackpad looks damaged.	Yes	Replace trackpad. Go to step 6.	K16
	No	Go to step 3.	
3. Reseat the trackpad flex cable on the logic board. Then verify trackpad functionality.	Yes	Loose cable. Issue resolved.	
	No	Go to step 4.	
4. Verify whether the trackpad connector on the logic board is damaged.	Yes	Replace logic board.	M24
	No	Go to step 5.	
5. In System Preferences: Universal Access, turn off special Keyboard and Mouse & Trackpad settings. Then verify trackpad functionality.	Yes	Settings issue resolved.	
	No	Go to step 6.	



6. Verify if a grounding strap is present between one screw of the trackpad and the system chassis.	Yes	Go to step 7	
	No	Refer to the Trackpad Grounding Strap section of Additional Procedures to install a grounding strap (Apple part # 922-9340) and retest.	
7. Install a known-good trackpad and verify that it works on customer's computer.	Yes	Replace unit's trackpad according to symptom found: - No trackpad response - Trackpad cursor not tracking properly - Trackpad button issues	K02 K12 K13
	No	Replace logic board.	M16

Built-in Trackpad Does Not Work

Unlikely cause: LCD, hard drive, optical drive

Quick Check

Symptom	Quick Check
Built-in Trackpad Does Not Work <ul style="list-style-type: none"> Cursor does not move. Select button of trackpad inoperable Multiple touch features inoperable 	<ol style="list-style-type: none"> Check for environmental factors such as humidity, hand lotion or jewelry. Check if user is touching the trackpad simultaneously with both hands. Clean the trackpad surface (with the computer powered off) using a clean, dry, lint-free cloth. Make sure all software and firmware updates have been applied.

Deep Dive

Check	Result	Action	Code
1. Verify that you see the trackpad continuously listed with USB devices in Apple System Profiler.	Yes	Go to step 5.	
	No	Go to step 2.	
2. Check trackpad for proper alignment and normal clicking motion and verify if trackpad looks damaged.	Yes	Replace damaged trackpad	K16
	No	Go to step 3.	



3. Reseat the trackpad flex cable to the logic board. Then verify trackpad functionality.	Yes	Loose cable. Issue resolved.	
	No	Go to step 4.	
4. Verify whether trackpad connector on the logic board is damaged.	Yes	Replace logic board.	M24
	No	Go to step 5.	
5. In System Preferences: Universal Access, turn off special Keyboard and Mouse & Trackpad settings. Set for normal use, enable and test multiple touch features. Then verify trackpad functionality.	Yes	Settings issue resolved.	
	No	Go to step 6	
6. Does the select button click? Check trackpad for proper alignment and normal clicking motion.	Yes	All trackpad issues resolved.	
	No	Go to step 7	
7. If the trackpad suffers from jumpy cursor behavior, verify if a grounding strap is present between one screw of the trackpad and the system chassis.	Yes	Go to step 8	
	No	Refer to the Trackpad Grounding Strap section of Additional Procedures to install a grounding strap (Apple part # 922-9340) and retest.	
8. Inspect for triggered red LSI next to trackpad set screw. Verify that a known-good trackpad works.	Yes	Replace trackpad according to symptom found. - No mouse/trackpad response - Trackpad cursor not tracking properly - Trackpad button issues - Trackpad LSI sensor triggered	K02 K12 K13 K90
	No	Replace logic board.	M16



Built-in Speaker Has No Audio

Unlikely cause: LCD, hard drive, optical drive

Quick Check

Symptom	Quick Check
Built-in Speaker Has No Audio Can't hear any audio from built-in speakers	<ol style="list-style-type: none"> 1. Make sure all software updates have been applied. 2. Check in System Preferences: Sound: Output that sound output is set to "Internal Speakers." 3. Use the F12 volume key to set the sound to maximum. 4. Reset PRAM.

Deep Dive

Check	Result	Action	Code
1. Check System Preferences: Sound: Output and verify that no external speakers, "Digital Out," or "Headphones" are being reported connected when there is none present.	Yes	Audio-out port is not damaged. Go to step 3.	
	No	Go to step 2	
2. With known-good headphones or speakers, plug them in/out to the audio output jack for several cycles. Verify that you get audio through external headphones/speakers when connected, and that you get audio switched to Internal speakers when disconnected..	Yes	Go to step 4	
	No	Loosen the logic board screws and slide the logic board so that edge connectors are all aligned to enclosure, then tighten back the screws. Go to step 3.	
3. With known-good headphones or speakers, verify that you get audio through headphones or external speakers. .	Yes	Go to step 4.	
	No	Replace logic board.	M09
4. Disconnect known-good headphones or speakers. Verify that you now get audio through internal speakers.	Yes	Go to step 5.	
	No	No audio coming from any of the three internal speakers. Replace logic board.	M09



5. Using balance slider in System Preferences: Sound: Audio Out, verify that all/left/center/right audio speakers working.	Yes	Internal Audio Out is functional,.	
	No	Go to step 6.	
6. Verify that affected speaker connector is properly inserted and that cable does not interfere with other elements and is free from damage.	Yes	Replace failing rear speaker or replace top case for left or right speaker failure.	X08
	No	Reseat speaker cable or replace damaged speaker.	X08

Distorted Sound from Internal Speaker

Unlikely cause: LCD, hard drive, optical drive

Quick Check

Symptom	Quick Check
Distorted Sound from Internal Speaker <ul style="list-style-type: none"> Distorted audio 	<ol style="list-style-type: none"> Reset PRAM. Adjust sound output and level in System Preferences: Sound: Output, and use the Balance to locate a left, right, or woofer speaker distortion source. Compare the same sound and same settings against another unit to make sure the sound is actually distorting.

Deep Dive

Check	Result	Action	Code
1. Comparing internal speakers with headphones, verify if distortion occurs on both headphones and internal speakers.	Yes	Audio source or gain issue. Reset PRAM, adjust sound level in System Preferences: Sound: Output, and retest with known-good audio source and external speakers. Go to step 5.	
	No	Internal speaker issue. Go to step 2.	



2. Use the Sound Output system preference to test the left and right speakers. If lower bass notes are distorted, right speaker/subwoofer may be defective. Verify that all speakers' sound is free of distortion, sounding clear and loud.	Yes	Issue resolved.	
	No	Adjust volume to test full range of volume settings. Go to step 3.	
3. Verify that affected speaker connector is properly inserted and that its cable is free from damage and is not interfering with other elements.	Yes	Go to step 4.	
	No	Reseat speaker cable or replace damaged rear speaker. Go to step 5.	X09
4. Verify that rear speaker membrane is free from dust or debris, and speaker membrane is not deformed/damaged.	Yes	Go to step 5.	
	No	Clean any dust or debris. Go to step 5. If membrane is damaged, replace rear speaker or replace top case for damaged left/right speaker(s).	X09
5. Verify left and right speakers are free from damage and do not create unwanted distortion with sound at full volume.	Yes	All speakers work at full volume; issue resolved.	
	No	Go to step 6.	
6. According to system serial number identification, check that logic board model matches the top case speakers model.	Yes	Go to step 7.	
	No	Replace incorrect part with correct model: -logic board if incorrect model -top case if incorrect model	M09 X09
7. Check if headphone sound has distortion.	Yes	Replace logic board.	M09
	No	Replace top case for speaker defects.	X09



Uncategorized Symptom

Quick Check

Symptom	Quick Check
Uncategorized Symptom Unable to locate appropriate symptom code	Verify whether existing symptom code applies to the issue reported by the customer. If not, document reported symptom and send feedback to smfeedback@apple.com stating that a suitable symptom code could not be found.



Mechanical Issues: Thermals and Enclosure

Reset/Power Button Stuck

Unlikely cause: LCD, hard drive, optical drive

Quick Check

Symptom	Quick Check
Reset/Power Button Stuck <ul style="list-style-type: none"> System will not power on System sounds bootROM unlock tone (a long extended tone) during startup System automatically starts up repeatedly 	<ol style="list-style-type: none"> Diagnose stuck button with SMC keyboard reset sequence Check for issue occurrence on battery and on AC power If on battery only, check battery using Notebook Battery and Adapter Diagnostic

Deep Dive

Check	Result	Action	Code
<ol style="list-style-type: none"> Reset SMC using keyboard 3 keys and power button. MagSafe LED can verify SMC reset. Momentary stop of battery charging will indicate SMC reset, orange LED will go green momentarily then return to orange. 	Yes	Keyboard reset works while holding 3 keys and toggling power button, multiple press and release of power button works to show power button not stuck or fixed.	
	No	SMC keyboard reset not working, suggests power button is open circuit or stuck down. Go to step 2.	
<ol style="list-style-type: none"> Disconnect battery and AC power for 30 seconds to perform a manual SMC reset. Apply AC power. Verify that power button works when pressed. 	Yes	SMC restored from power removal sequence. Power button now working properly.	
	No	Power button stuck or open. Connect known-good power supply and go to step 3.	

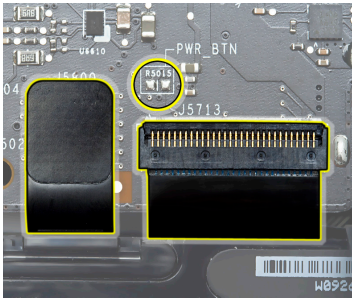

3. Inspect keyboard flex cable for loose or damaged connections. Align and reseat flex cable to ensure proper connections. Verify that power button now works correctly.	Yes	Cable reseat restored power button operation.	
	No	Power button still appears to be stuck or open. Go to step 4.	
4. Use a jeweler's flatblade screwdriver to assert power on by touching power-on switch pads on logic board (see picture on left). Verify that system powers on when shorting power-button pads.	Yes	System powers on indicating top case power on key circuit is open. Replace top case for open power button.	X14
	No	Power button circuit appears to be closed suggesting a stuck power button. Go to step 5.	
5. Disconnect the internal keyboard flex cable and assert power-on switch pads on logic board. Removing top case power button from circuit should free on-board switch to work properly.. Verify that system powers on.	Yes	On board power-on switch pads now starts the system. Replace top case due to stuck power button.	X14
	No	Go to No Power symptom chart.	

System Runs Hot

Unlikely cause: LCD, hard drive, optical drive

Quick Check

Symptom	Quick Check
System Runs Hot <ul style="list-style-type: none"> System feels very warm Fan not working Fan running at full speed 	<ol style="list-style-type: none"> Verify the computer operating on a flat, hard surface with no blocked vents. Verify the computer is not running hotter than expected for normal operation. If possible, compare to a similarly configured computer. Reset SMC. Inspect fan performance Run AHT for thermal sensor test.



Deep Dive

Check	Result	Action	Code
1. Verify that the system is running as expected (compared to similar system).	Yes	Use “Apple Portables: Operating Temperature” (Knowledge Base HT1778) to inform user it is operating normally.	
	No	Go to step 2.	
2. Verify that there are no runaway applications. See “Runaway applications can shorten battery run time” (Knowledge Base TS1473).	Yes	Check with the vendor for compatibility and software update.	
	No	Go to step 3.	
3. Fan is typically on at minimum speed. Perform SMC reset (or remove all power sources for 15 minutes). Verify that the fan is running properly.	Yes	Go to step 5.	
	No	Fan not running or always running at full speed. Go to step 4.	
4. Reseat fan connection to logic board or test a known-good fan. Replace a fan that is not spinning or replace a logic board for not operating with known-good fan. Verify that the system is running as expected.	Yes	Reseating or replacing bad fan resolved issue. Replace logic board if it does not pilot a known-good fan.	X99 or M18
	No	Go to step 5.	
5. Run ASD tests for thermal and fan speed sensors monitoring and verify that all tests pass without error..	Yes	Reseating fan connection resolved issue. If no error is found in running tests, but system still runs too hot, go to step 6.	
	No	-If TSOP thermal sensor test fails reseat trackpad connector on logic board and retest. If TSOP error persists replace trackpad. -If fan speed sensor test fails, replace fan. -If TCOP, TCOD, TH1H or TN0D thermal sensor test fails go to step 6	K12 X22



6. Remove logic board and heatsink, and verify presence of correct thermal grease, heatsink seating on logic board, and tightened screws with sufficient torque.	Yes	Go to step 7	
	No	Apply correct model and amount of thermal grease, reseal heatsink and apply correct torque to heatsink screws and retest. If issue persists replace heatsink and go to step 7	X10
7. After fan or heatsink reseating/ replacement, verify that the computer fan is running as expected.	Yes	Failing fan or heatsink. Issue resolved.	
	No	Replace logic board. Go to step 8.	M23
8. After logic board replacement, verify that the computer fan is running as expected.	Yes	Defective logic board. Issue resolved.	
	No	Troubleshoot other software related overheating cause.	

Uncategorized Symptom

Quick Check

Symptom	Quick Check
Uncategorized Symptom Unable to locate appropriate symptom code	Verify whether existing symptom code applies to the issue reported by the user. If not, document reported symptom and send feedback to smfeedback@apple.com stating that a suitable symptom code could not be found.

Take Apart

MacBook (13-inch, Late 2009)



General Information

Connector Types on Logic Board

On the logic board are 7 types of connectors, each requiring special handling. Make sure you read these tips before handling the connectors.

Battery Connector

- Use black stick or fingernails to pull up evenly on sides of connector.
- Align connector over pins and press onto board when reconnecting.
- Do not pull wires.

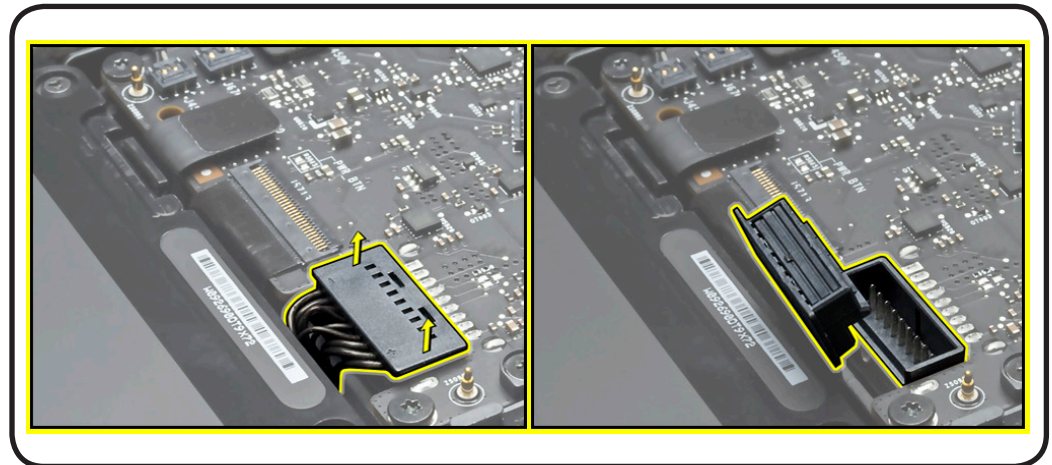

Vertical Insertion (JST)

- Use black stick under cable to remove.
- Keep connector level to board when disconnecting and reconnecting.
- Press evenly when reconnecting or connector can be tipped up and not fully seated.

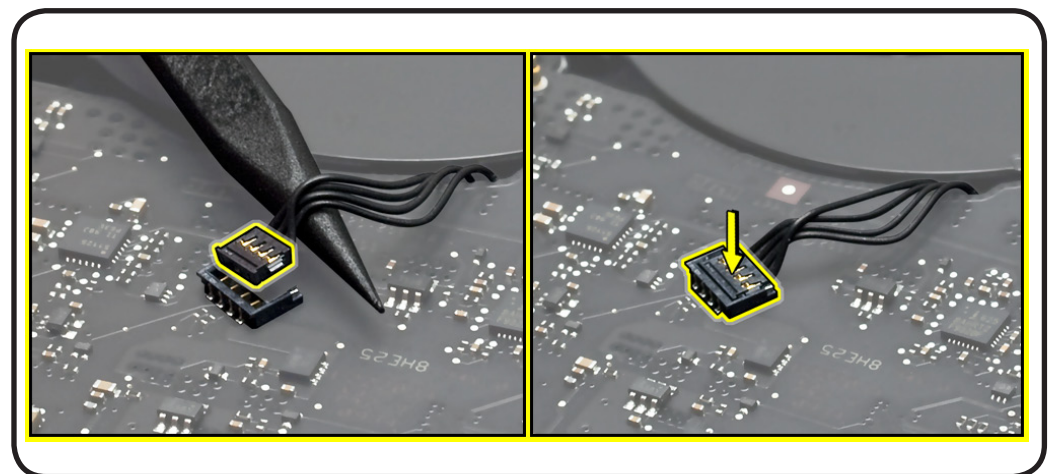

Examples:

- fan
- rear speaker
- left speaker
- right speaker
- LED sleep
- microphone



Locking Lever

- Flip up lever 90 degrees for cable removal.
- Slide connector into receptacle on same horizontal plane as board.
- Lock down lever after inserting cable.

Example:

- keyboard flex cable

Caution: Use Kapton tape to pull the keyboard flex cable **all the way** into connector to prevent “no power” symptoms.

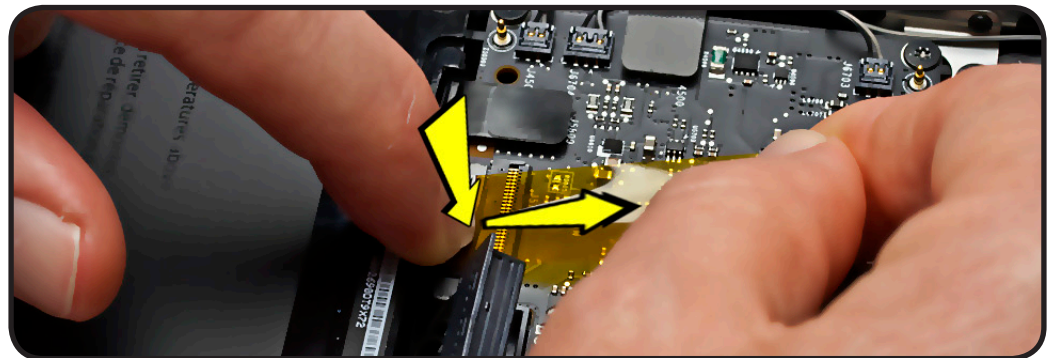
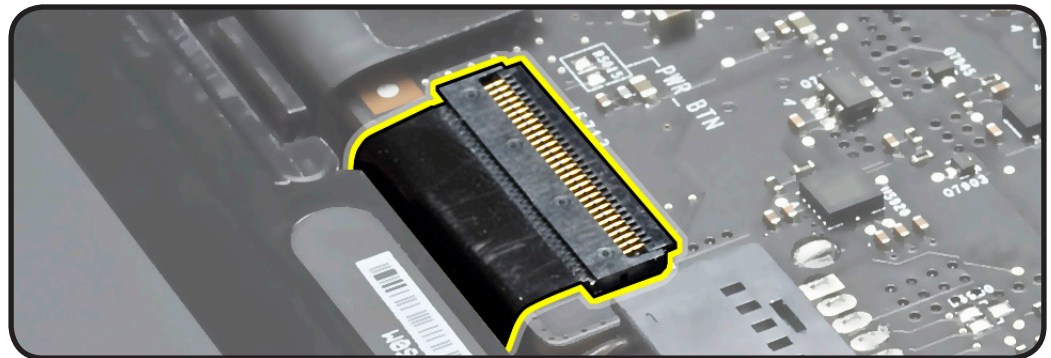

Thin, Multi-Pin Horizontal Insert

- Remove EMI gasket, loosen tape over locking bar, and flip over locking bar before disconnecting cable
- Use fingernails or tweezers to remove evenly.
- Slide connector into receptacle on same horizontal plane as board.

Example:

- LVDS cable with locking bar

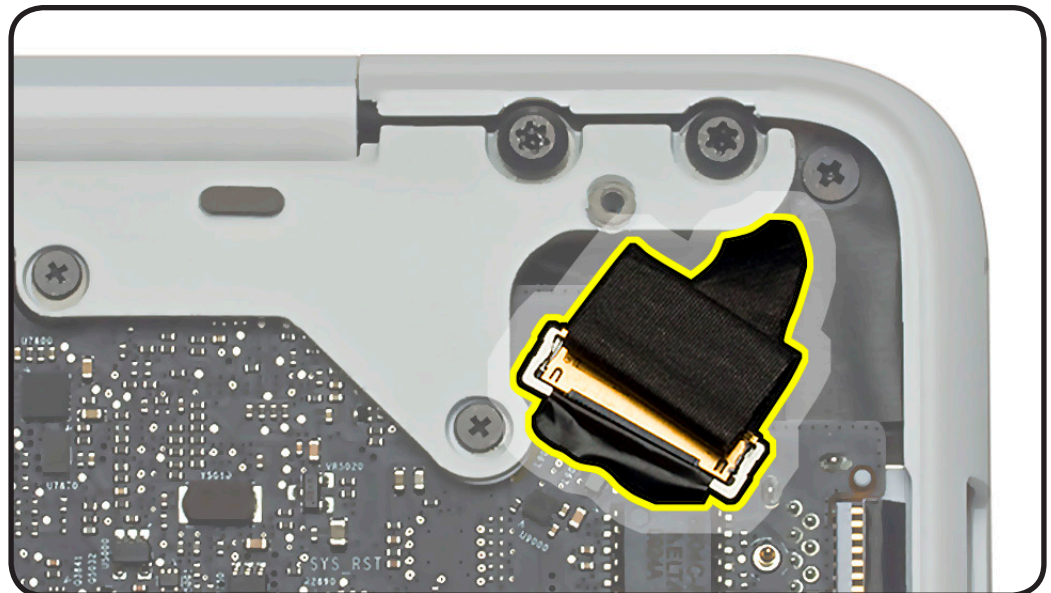



Caution: Remove gasket **before** disconnecting LVDS cable. Pull the cable, not the locking bar.

Replacement Caution: Before replacing gasket, make sure cable is fully installed—no gold traces visible.

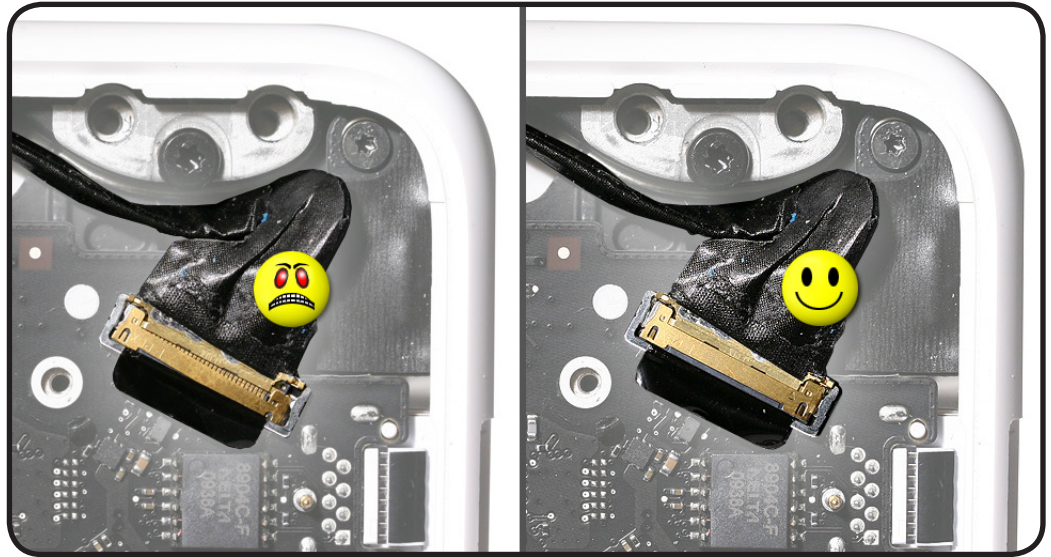

Replacement Caution: To prevent video “noise,” a whining sound, no video, or a short to the logic board, be sure to place EMI gasket on connector—**positioned precisely where shown**—**after** cable is fully connected to logic board.

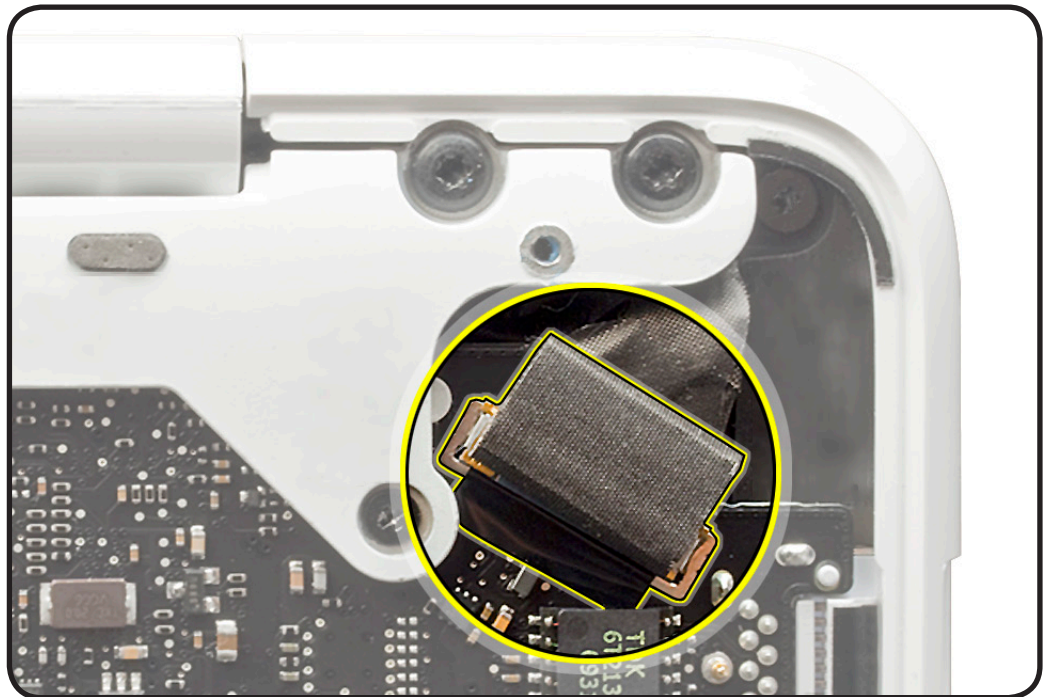



Low-Profile Solid Platform Flex

- Use black stick and gentle rocking motion to release tension to remove cable.
- Keep connector level to board and press evenly to install cable.

Examples:

- optical drive
- trackpad
- hard drive connector
- AirPort/Bluetooth flex

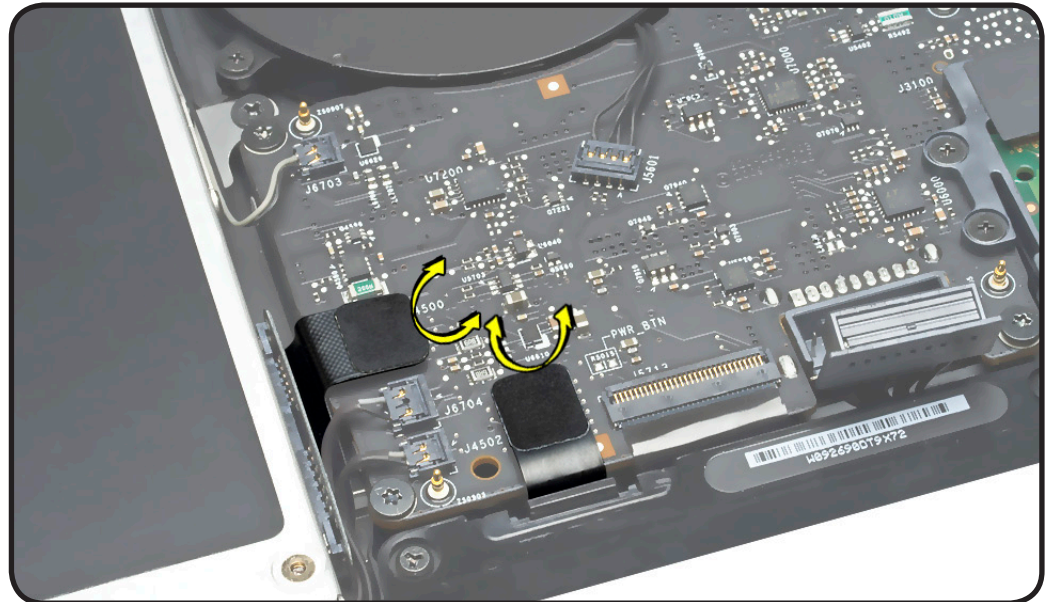

Horizontal Install

- Pull connector, not cable, to remove.
- Slide connector into receptacle on same horizontal plane as board.

Example:

- MagSafe cable on underside of board

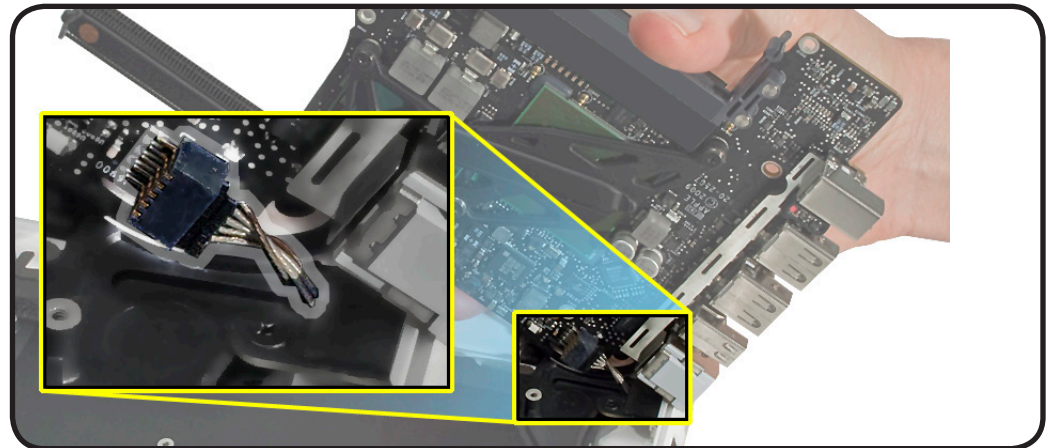

Tools

Caution: To prevent scratches or other cosmetic damage to the computer housing, use a soft cloth as a protective layer when removing and installing the external screws.

The following tools are required to service the computer:

- Clean, soft, lint-free cloth
- ESD wrist strap and mat
- Magnetic Phillips #1 screwdriver
- Magnetic Phillips #0 screwdriver
- Magnetic Phillips #00 screwdriver
- Torx T6 screwdriver
- Torx T8 screwdriver



- Large tri-lobe #0 screwdriver (Apple part number 922-8991)
- Black stick (Apple probe tool, part number 922-5065) or other nonconductive nylon or plastic flatblade tool
- EMI-safe plastic or nylon tweezers for installing flex cables (optional)
- Thermal grease (Apple thermal compound syringe, part number 922-7144)
- Alcohol wipes
- Foam wedge fixture for display assembly removal (Apple part number 922-8779)
- Kapton tape
- Magnifying glass, for reading serial number etched on bottom case
- Digital volt meter (troubleshooting)

If available, a torque driver that measures in inch/pounds (Kgf/cm) is recommended for replacing the 6 display module screws.



Refer to Knowledge Base article “Hand Tools for Desktop and Portable Repairs--AP/CA/EU/JP/LA/US” to purchase tools: <http://support.apple.com/kb/HT3452>

In addition, the following software programs are required for troubleshooting:

- Apple Service Diagnostic (ASD), version 3S136 or later
- Apple Hardware Test, version 3A181 or later for MacBook (13-inch, Late 2009); version 3A199 or later for MacBook (13-inch, Mid 2010)

Icon Legend

The following icons are used in this chapter:

Icon	Meaning
	Warning or Caution
	Check mark; make sure you do this
	Challenging procedure; requires more thought and/or time until you are familiar with it
	Do not touch



Temperature Concerns

The normal operating temperature of this computer is well within national and international safety standards. Nevertheless, customers may be concerned about the generated heat. To prevent an unneeded repair, you can compare a customer's computer to a running model, if available, at your repair site. For more information on temperature concerns and customer perception, refer to Knowledge Base article 30612 "Apple Portables: Operating Temperature."

<http://support.apple.com/kb/HT1778>

Replacement Steps

When there are no replacement steps listed, replace parts in the exact reverse order of the Removal procedure.

Note About Images In This Guide

Because a pre-production model was used for most of the images shown in this manual, you may notice small differences in appearance between the image pictured and the computer you are servicing. However, although the appearance may differ, the steps and sequence are the same unless noted.

Screw Sizes

All screw sizes shown are approximate and represent the total length of the screw.



Bottom Case

First Steps



Warning:

- Shut down computer.
- Wait 10 minutes.
- Unplug all cables.
- Put on ESD strap.



Tools

- Clean, soft, lint-free cloth
- ESD wrist strap and mat
- Magnetized Phillips #00 screwdriver
- Black stick
- Magnifying glass

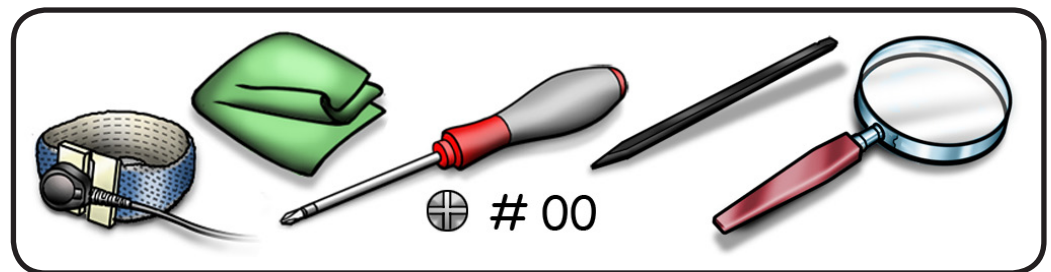



Removal

Caution: To prevent scratches, use a protective cloth when working with metal tools.



- 1 Remove 8 (4.3-mm) 922-9208 screws.

Note: Screws must be removed and installed at an angle.

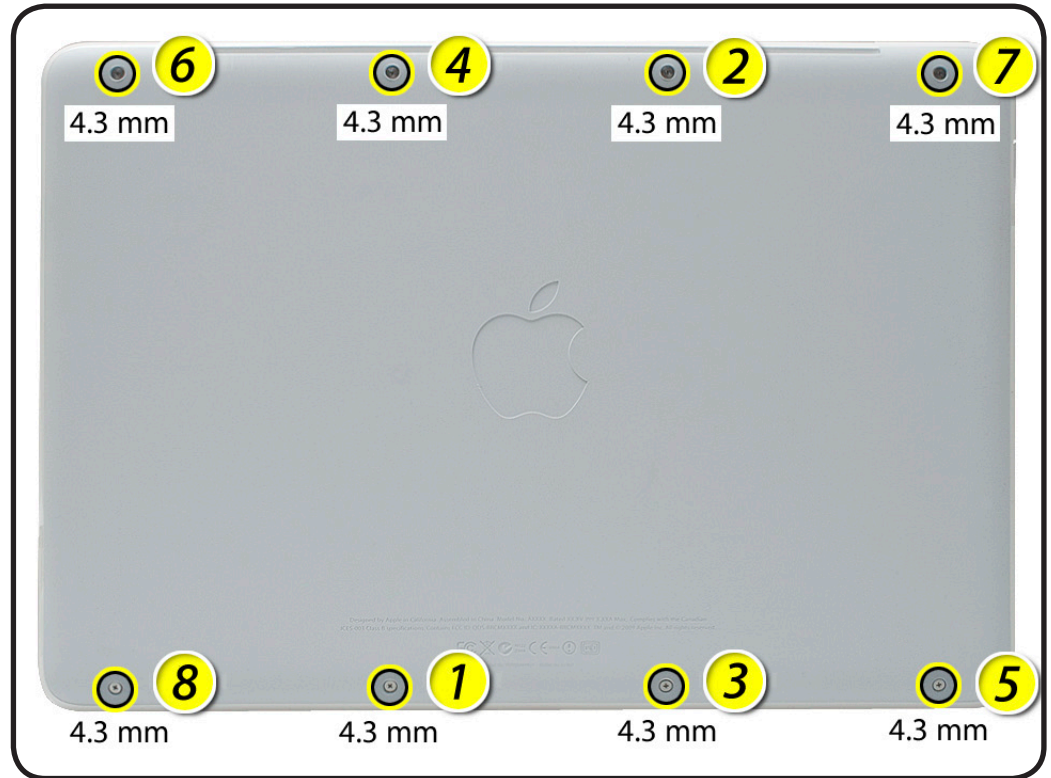
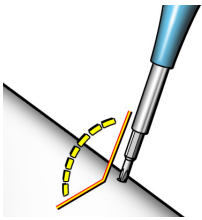

Replacement Note: Install screws in the order shown.

- 2 Lifting from the back, remove bottom case.
In the center and at each side are clips that attach to 3 snaps on the top case.





- 3 Warning:** If performing any other repairs, be sure to disconnect the battery cable. Use black sticks or fingernails to evenly disconnect cable.

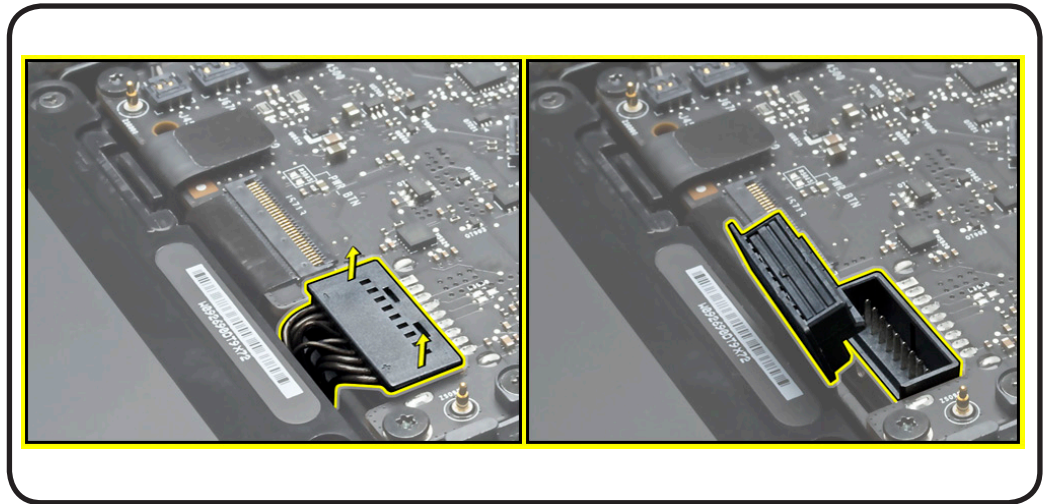

Replacement

- 1** When replacing a bottom case, retain the customer's bottom case until the repair is complete. Before installing the new bottom case, write the serial number on the inside of the bottom case. You might need a magnifying glass to read it. Refer to [Transferring the Serial Number](#).

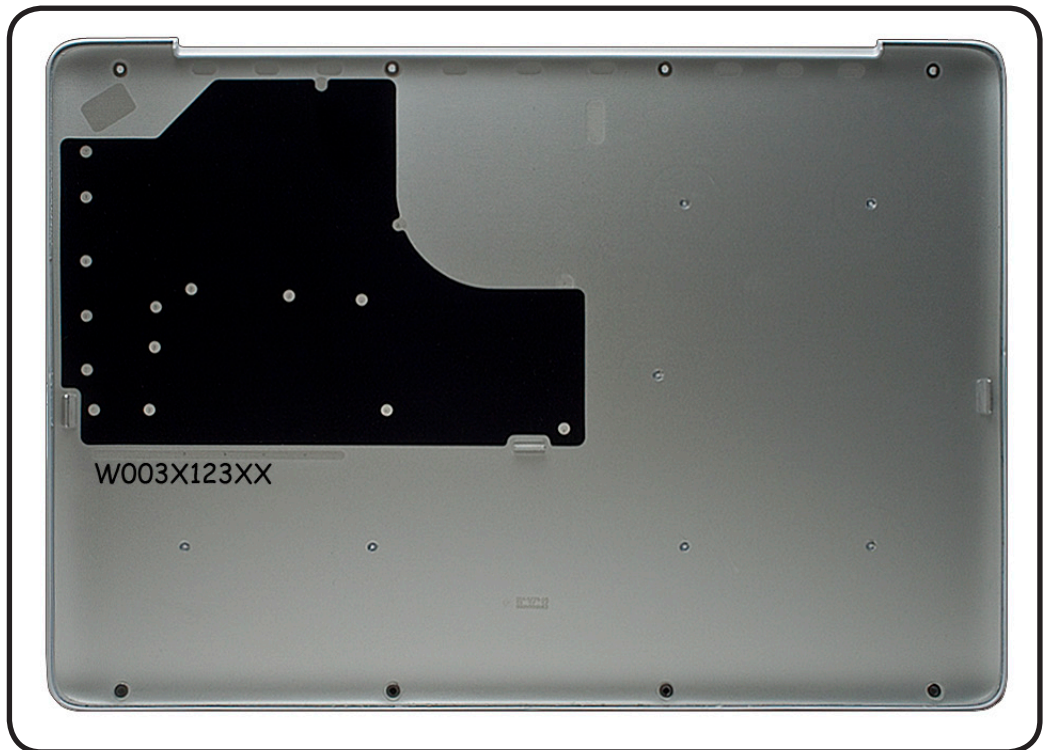



- 2** Check top case to make sure 3 snaps are intact.

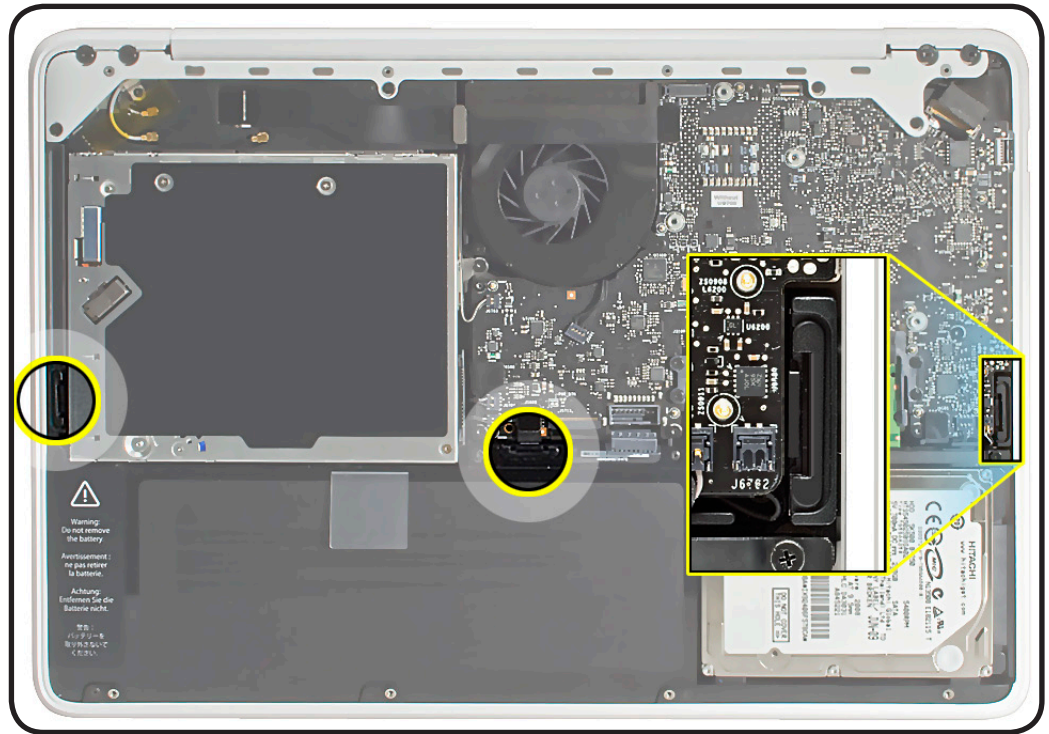

- 3** Check bottom case for
- 3 clips
 - 8 screw washers
- If any are damaged, replace bottom case





- 4 Align notches in bottom case to display clutch.
- 5 Install bottom case by securing 3 snaps and aligning 8 screw holes.





Top Case Snaps

First Steps

Remove:

- Bottom case

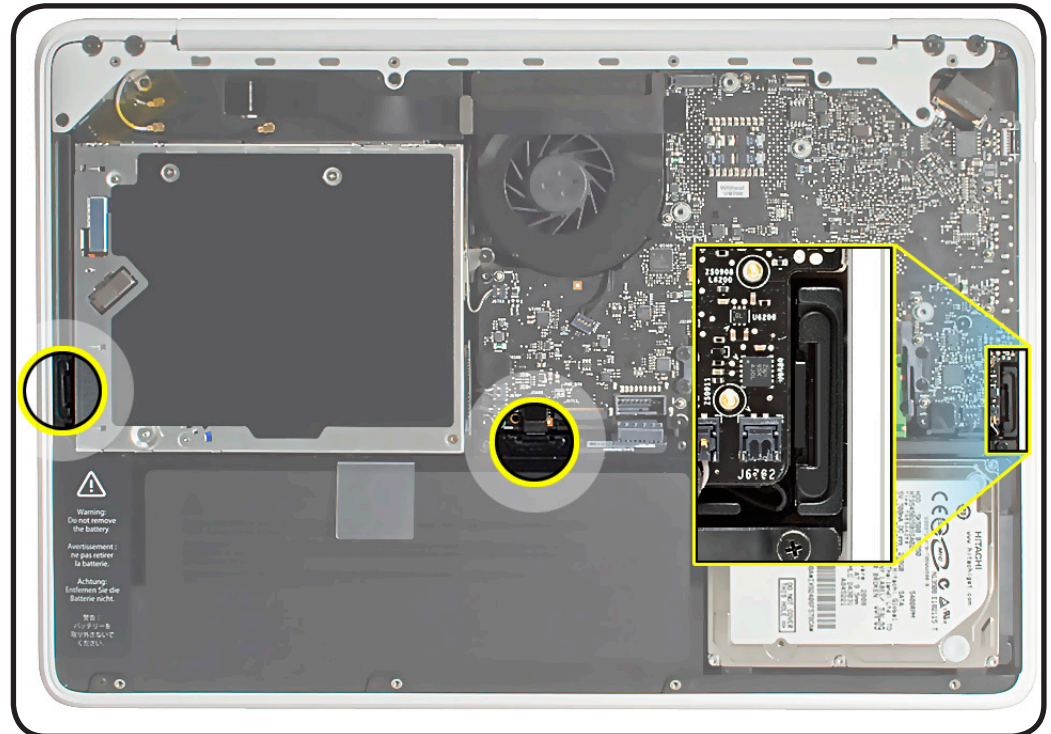

Before you begin this procedure, disconnect the battery from the logic board. Failure to do so could damage the computer.

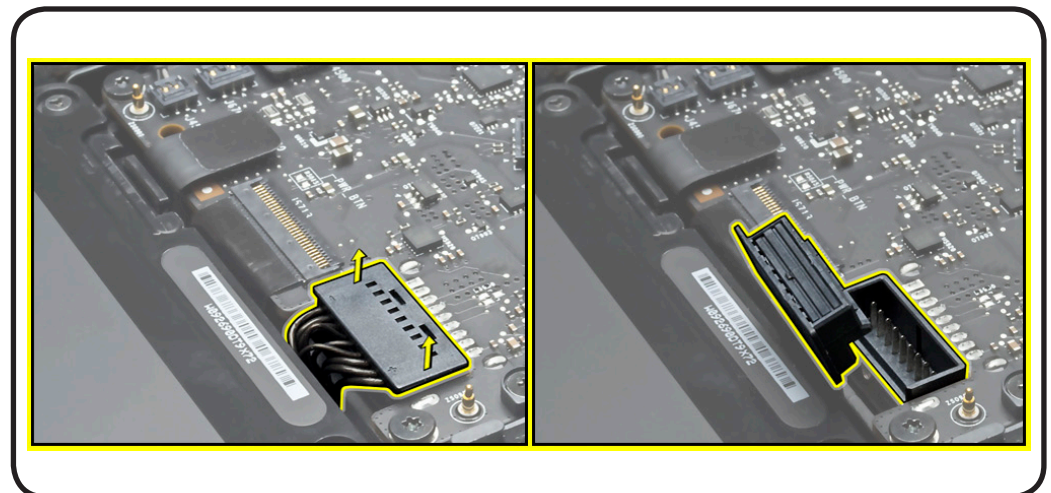



Tools

- Clean, soft, lint-free cloth
- ESD wrist strap and mat
- Black stick

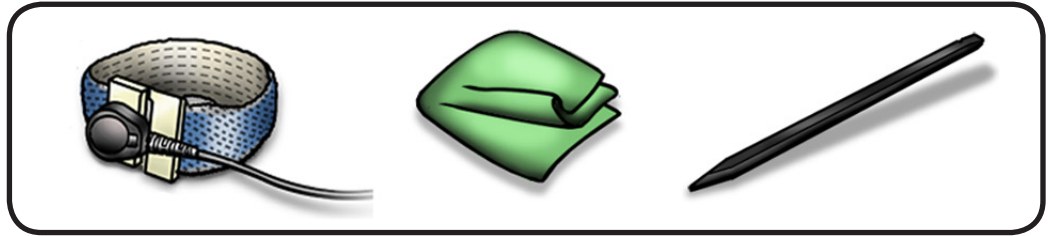

Removal

- 1 Use a black stick to push rear edge of snap out of slot.

Note: If the snap you need to replace is on the battery, remove battery first.

- 2 If the snap is near the logic board or optical drive, remove those parts first.

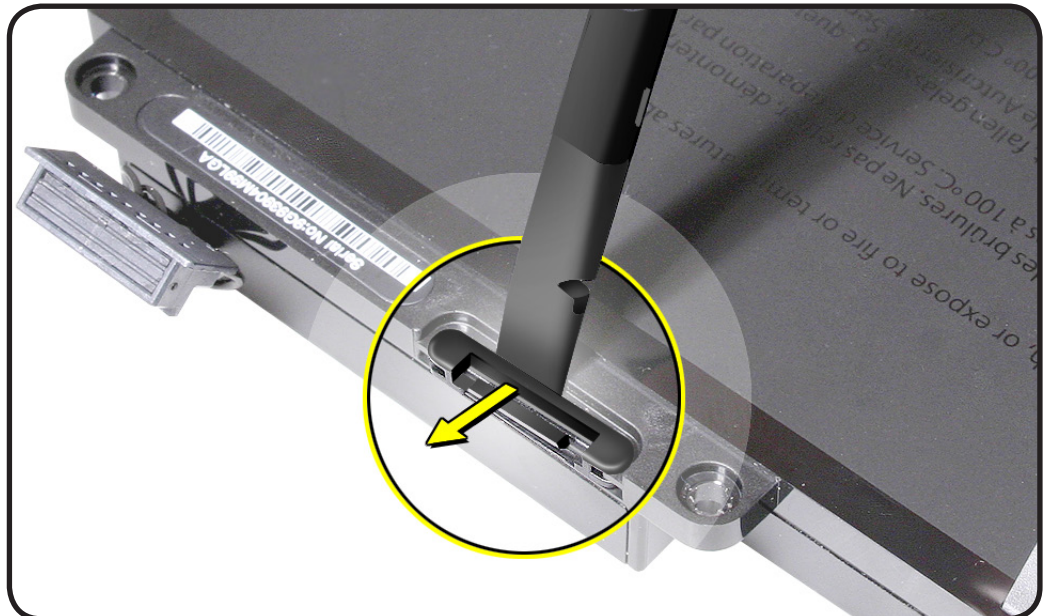

Replacement Note: All 3 snaps are identical; install flat edge into slot.

Apple part # 922-9441 includes a package of 5 snaps.

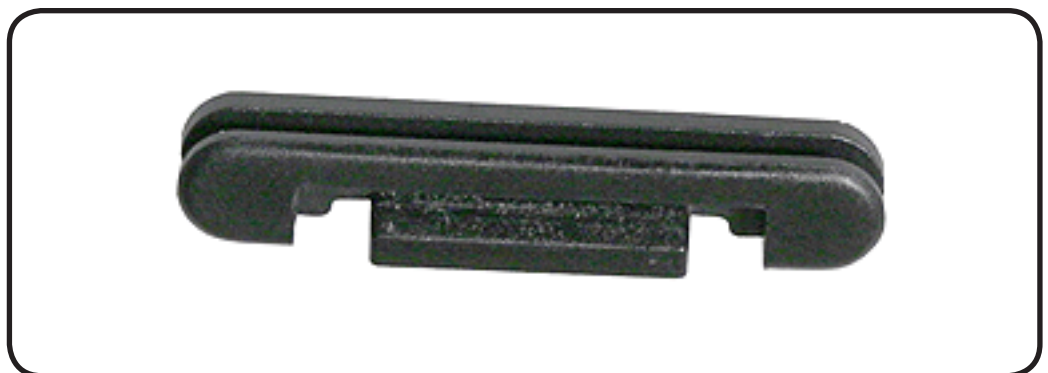



Battery

First Steps

Remove:

- Bottom case



Before you begin this procedure, disconnect battery from the logic board. Failure to do so could damage the computer.

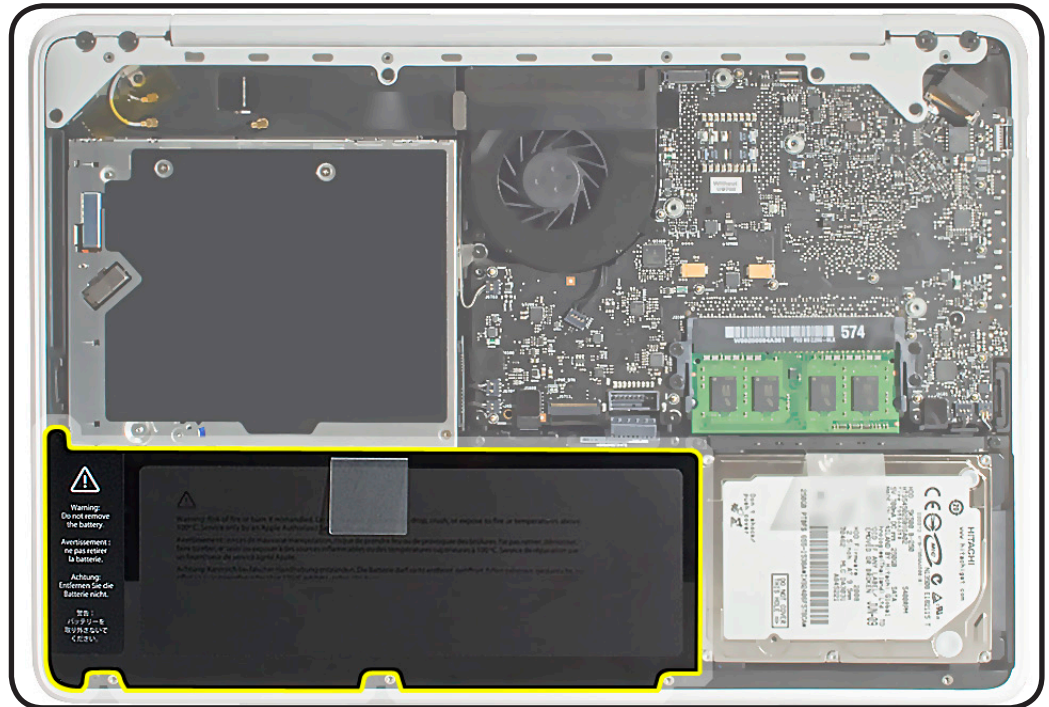

Tools

- Clean, soft, lint-free cloth
- ESD wrist strap and mat
- Black stick
- Large tri-lobe #0 screwdriver (922-8991)
- Magnetized Phillips #00 screwdriver

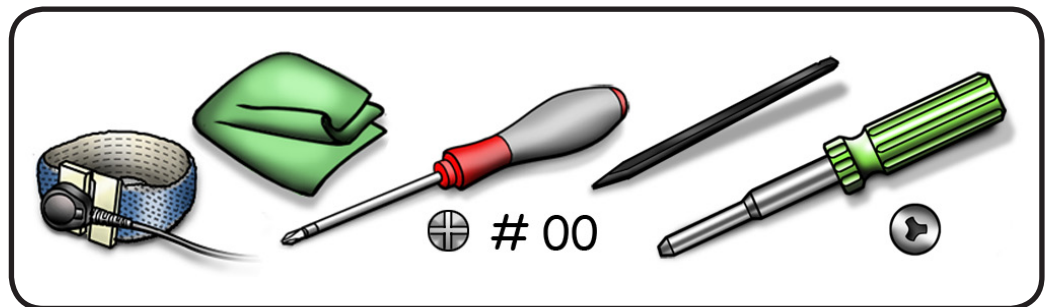



Removal

Important: Battery removal is only required when replacing battery, trackpad, or top case. Other internal repairs require disconnecting the battery cable but not removing the battery.



- 1 Use fingernails or black sticks to evenly disconnect battery cable.

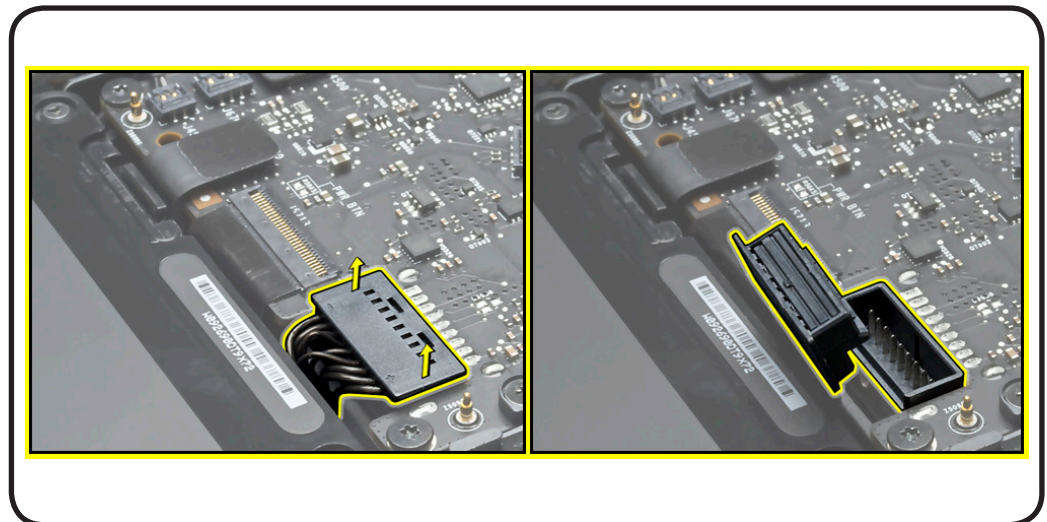

- 2 Remove screws:
 - 3 (5.1-mm) tri-lobe 922-9249 or 922-9515 (dependent on findings in GSX)
 - 3 (3.12-mm) Phillips 922-9211

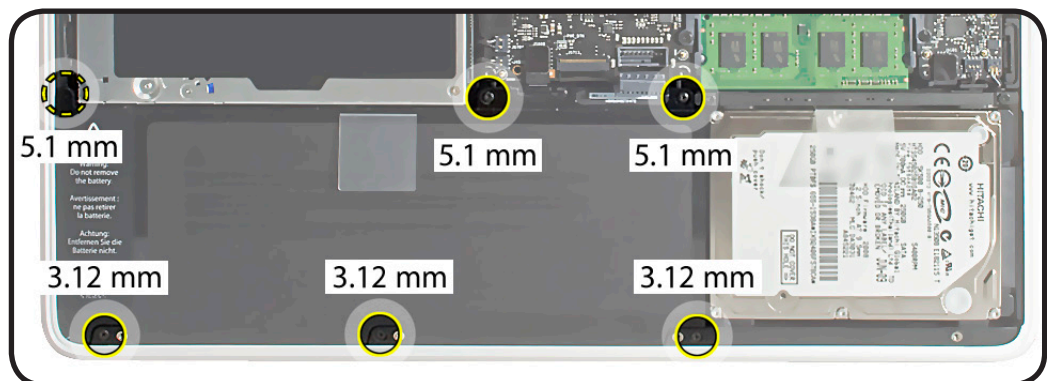



- 3 Use pull-tab to tilt out battery.



Warning: Underside of battery is soft.

- Do not puncture or press on battery.
- Hold battery by edges only.
- If setting battery aside, make sure surface is clean—free of dust, dirt, screws, etc.

Warning: If mylar covering battery is punctured, do not re-use battery.

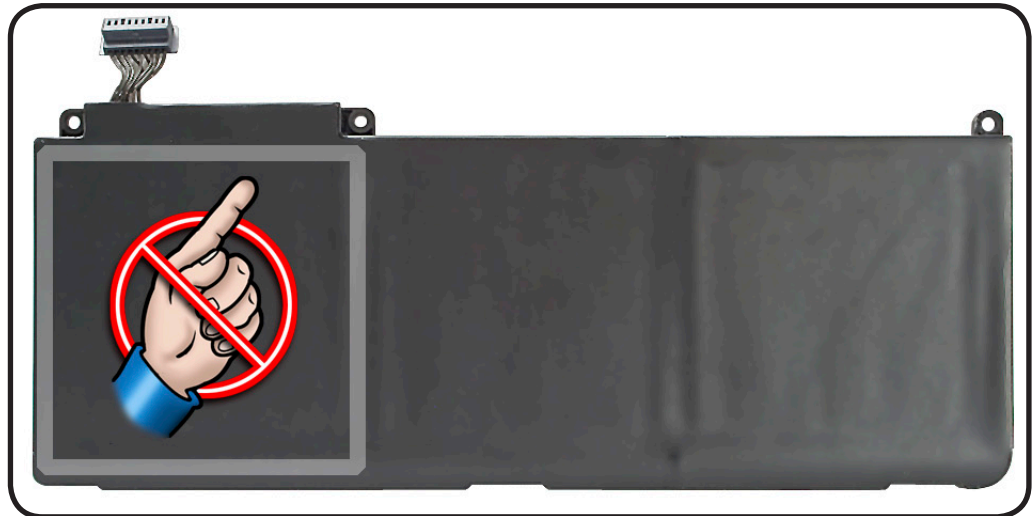

Replacement

- 1 Slide front edge of battery under 3 tabs.

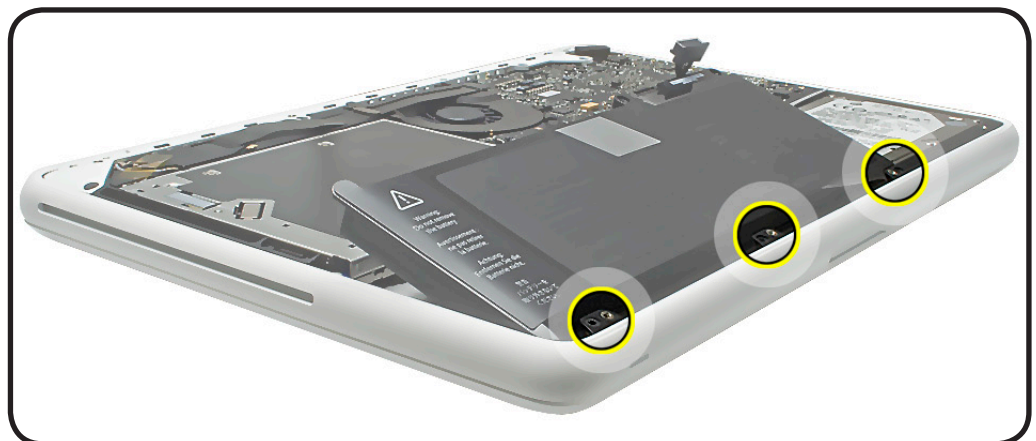



2 Install screws in order.

Note: If installing a new battery, attach the new battery label (refer to battery label inbox instructions).

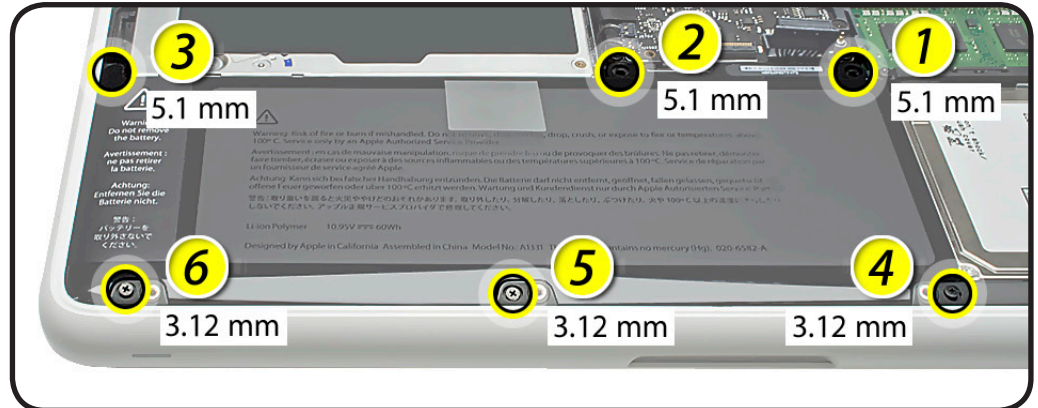

3 If performing other repairs, be sure to leave battery cable disconnected.

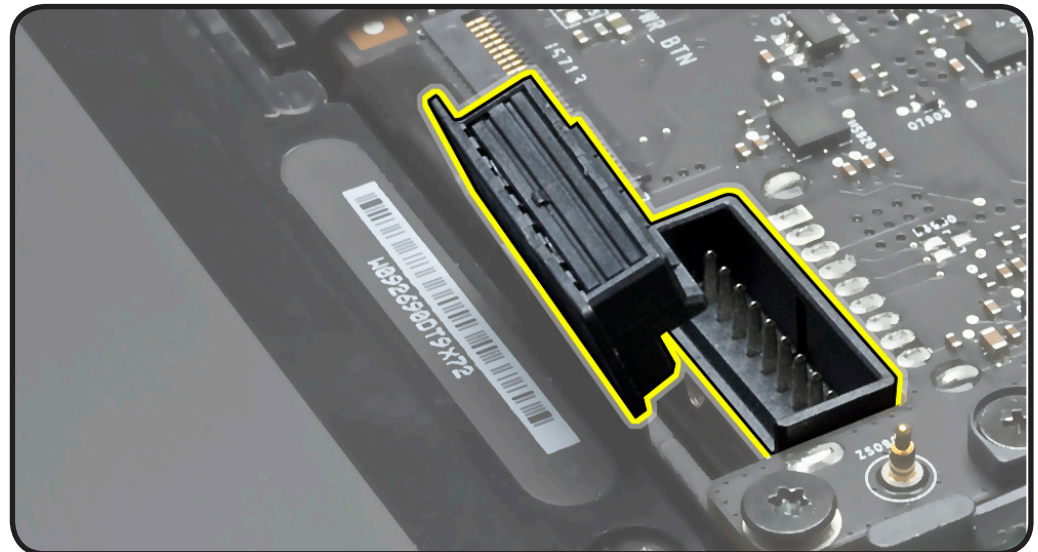



Trackpad

First Steps

Remove:

- Bottom case
- Battery

Trackpad Kit 922-9175 922-9551, or 661-5591

(depending on findings in GSX) includes:

- trackpad
- 2 metal flexures
- 8 #00 Phillips screws
- 1 Torx T6 set screw

Note: Although black and silver-colored screws are included in kit, you probably will not use all of them. Replace like-for-like only as described in steps.

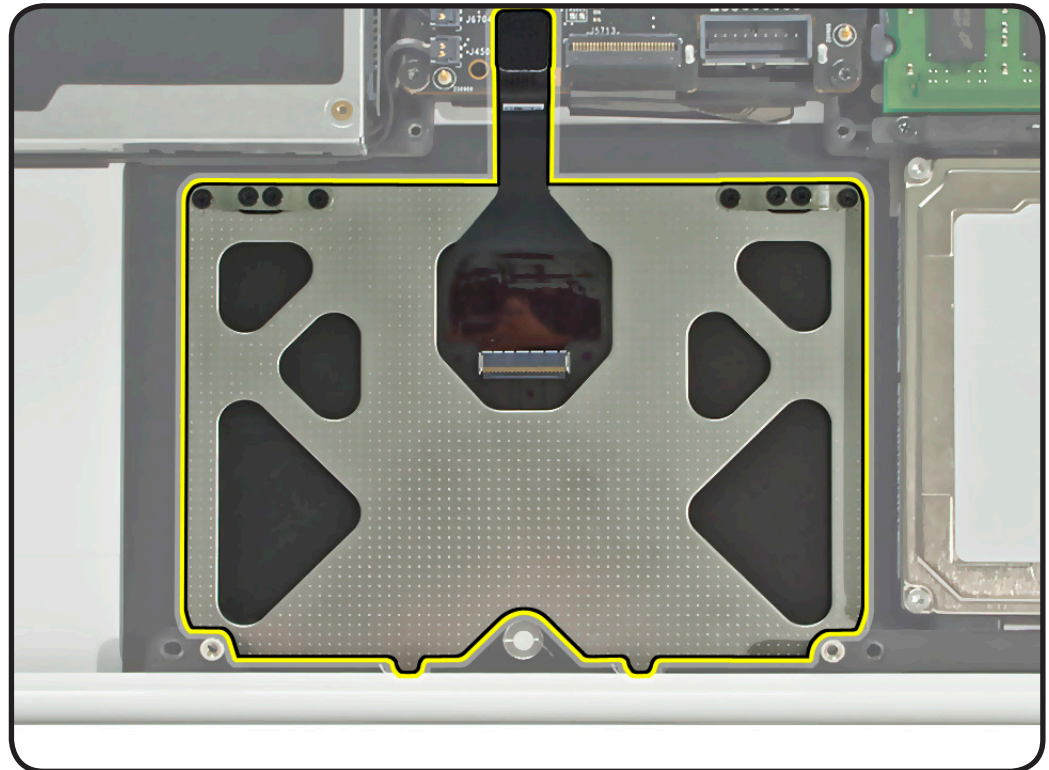

Tools

- ESD wrist strap and mat
- Sticky (Post-it) notes
- Black stick
- Magnetized Phillips #00 screwdriver
- Magnetized Torx T6 screwdriver
- Clean, soft, lint-free cloth (optional)

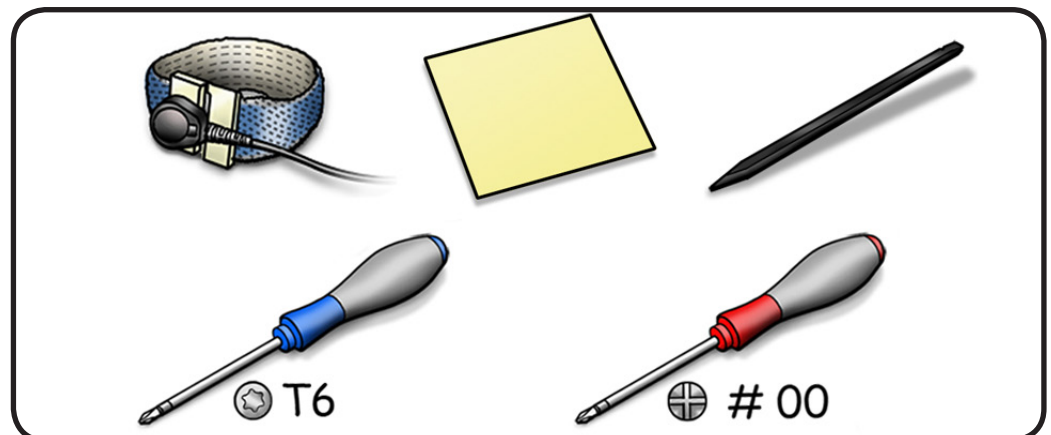



Removal

Important: Keep trackpad level (aligned with top case) on a flat surface whenever removing or installing flexure screws.

1 Disconnect trackpad flex cable.

2 Remove 4 Phillips #00 (1.32 mm) screws from flexures.



3 Note location of large T6 set screw, but **do not remove it**.



4 Dispose of 4 old screws; they lose their ability to hold securely if reused.

5 Tilt trackpad down to clear supports in front edge of top case.

Note: Although they are not shown in this image, do not remove flexures.

6 Remove trackpad from top case.

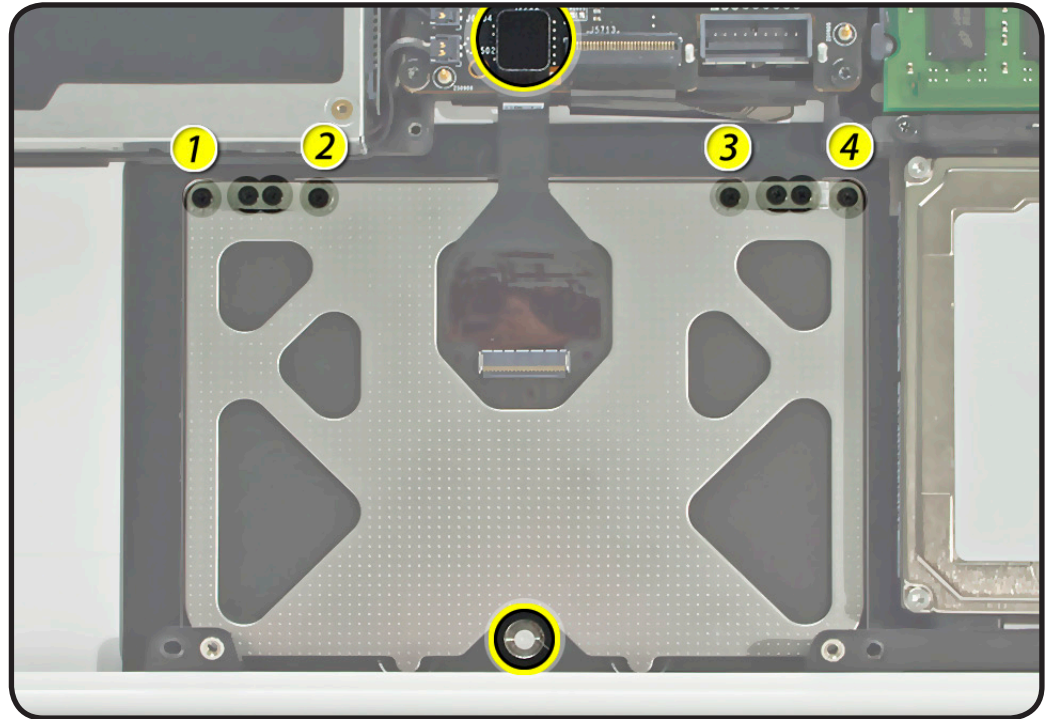



Replacement

Important: Discard 4 old screws, and use those included (like-for-like) with trackpad kit (or with new top case).

- 1 Make sure flex cable is not pinched.
- 2 Tilt trackpad into place, inserting front edge first.

Important: Avoid rubbing edges of trackpad against top case. This could cause tiny cracks to form on the trackpad.

- 3 Loosely install 4 flexure screws (the shortest screws) in order shown. Do not tighten yet.

Caution: Flexures are delicate and easily bent. Apply light pressure only. If damage occurs, use replacement parts from kit.

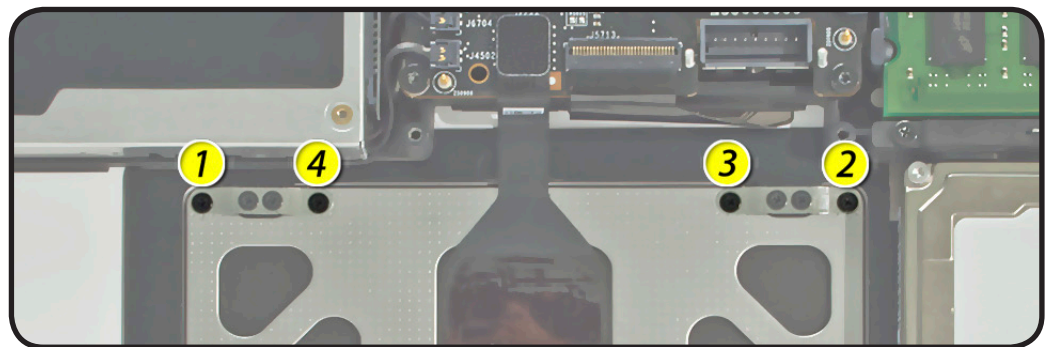
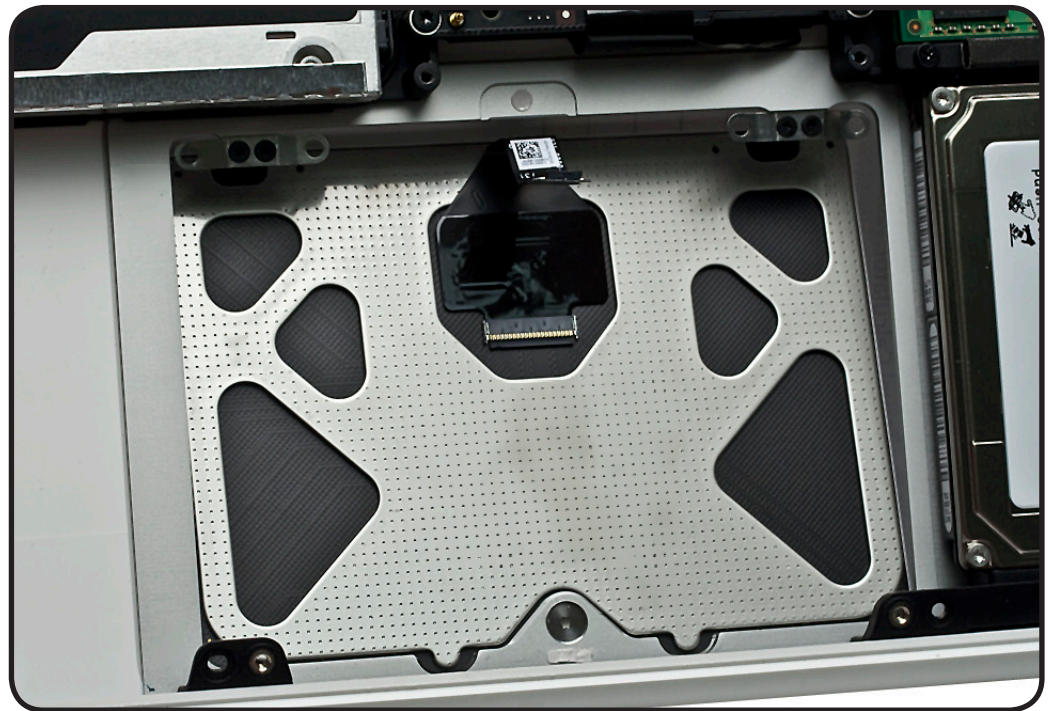



- 4** On the palm rest, insert one sticky (Post-It) note into gap on each of the four sides of trackpad.

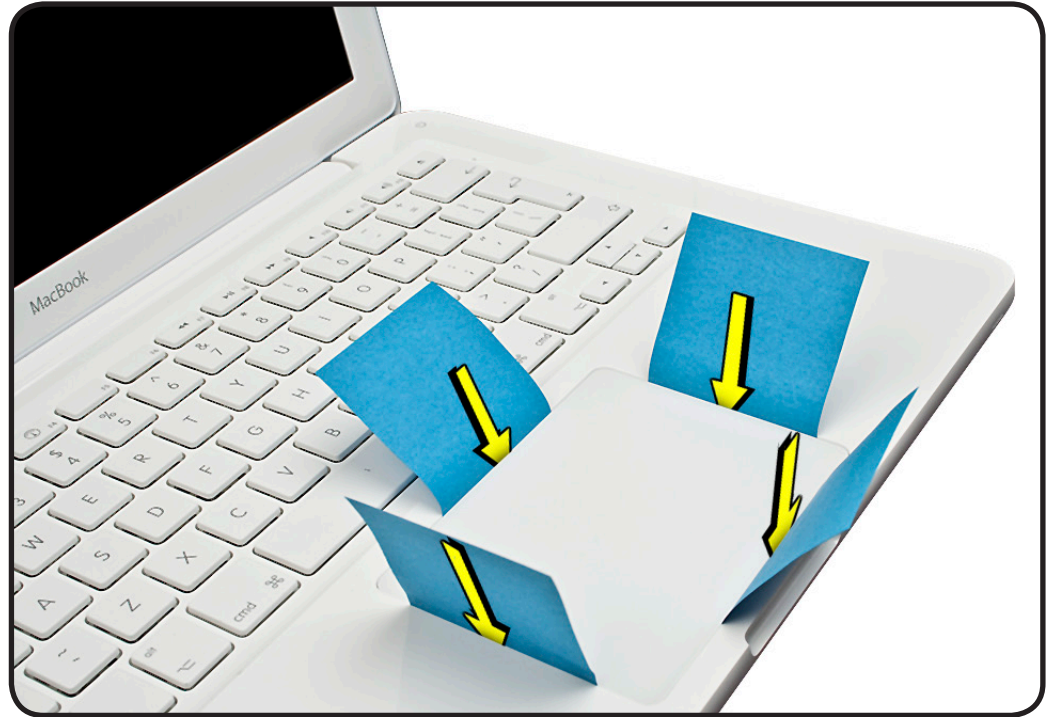

- 5** Fold sticky notes over so that top case can be laid flat.

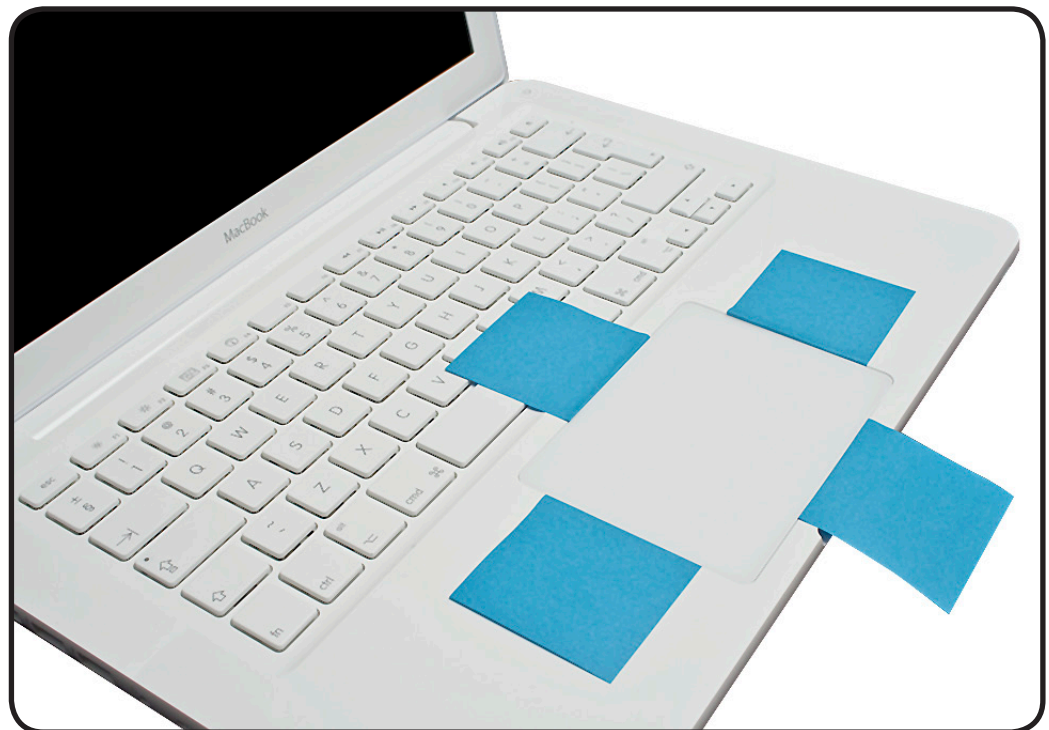



6 Caution: Without bending flexures, tighten 4 outer screws.

7 Inspect that gaps between trackpad and top case are even on all sides. If not, loosen screws and adjust.

Important: Check that trackpad is consistently level (aligned) with top case.

8 Check large T6 set screw.

9 If necessary, slowly turn set screw in small increments until trackpad has a normal clicking motion.

Important: Do not overtighten set screw or you may damage trackpad.

10 Connect flex cable to logic board.

11 Verify correct trackpad operation after reassembling computer.

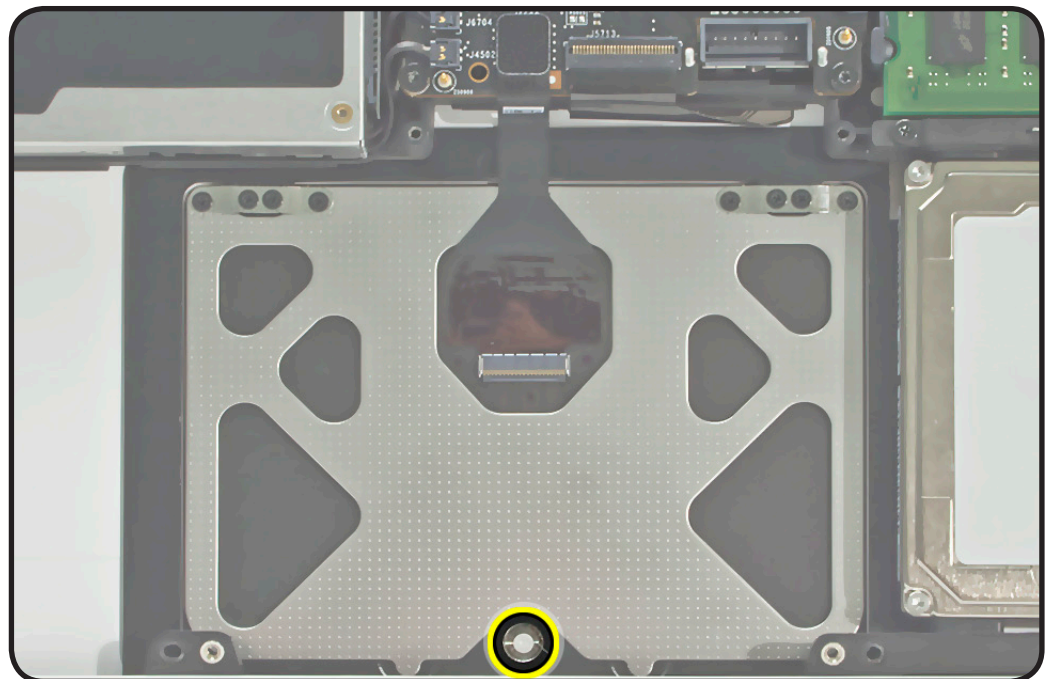
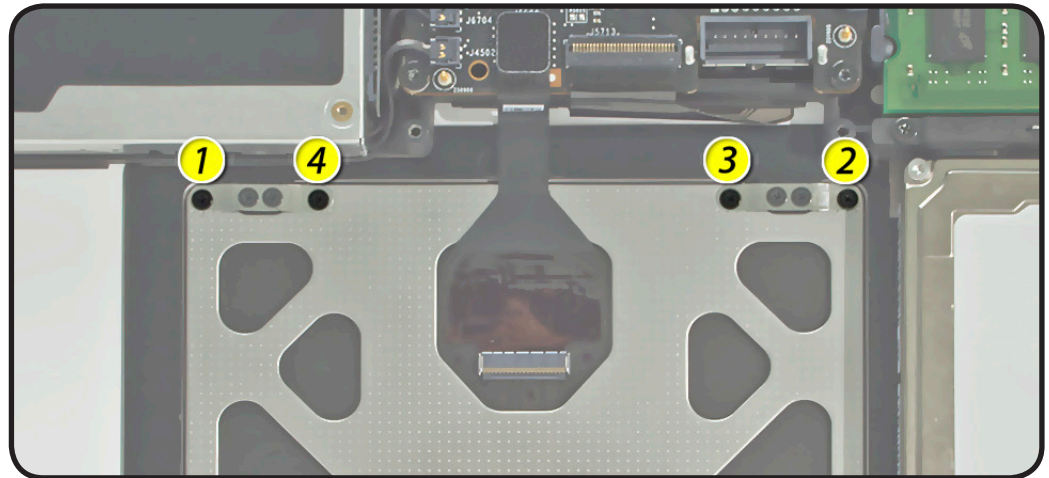



Hard Drive Bracket

First Steps

Remove:

- Bottom case



Caution: Make sure data is backed up before removing hard drive.

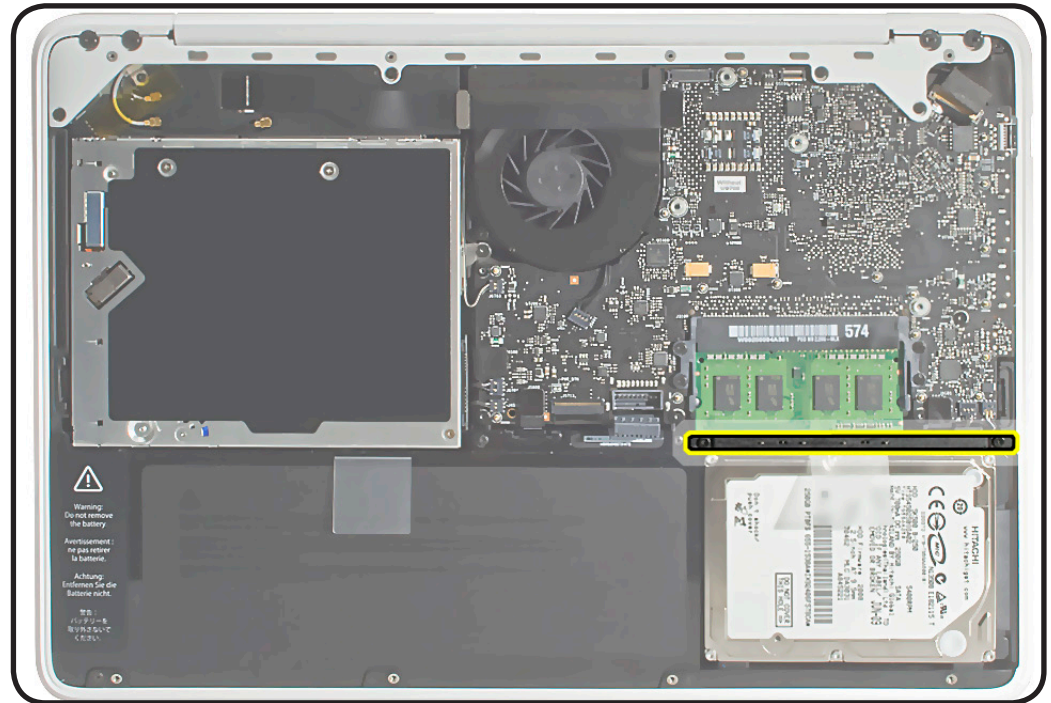

Before you begin this procedure, disconnect the battery from the logic board. Failure to do so could damage the computer.

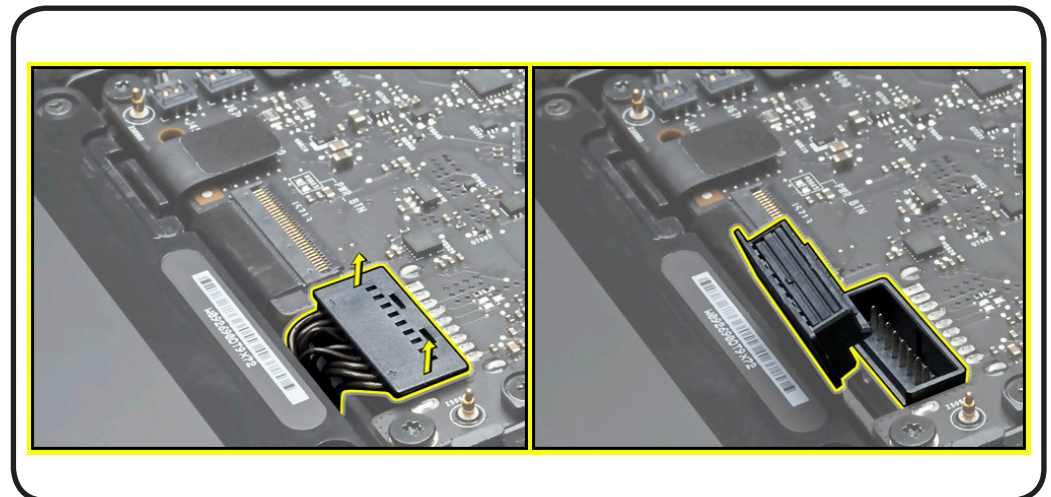



Tools

- Clean, soft, lint-free cloth
- ESD wrist strap and mat
- Magnetized Phillips #00 screwdriver

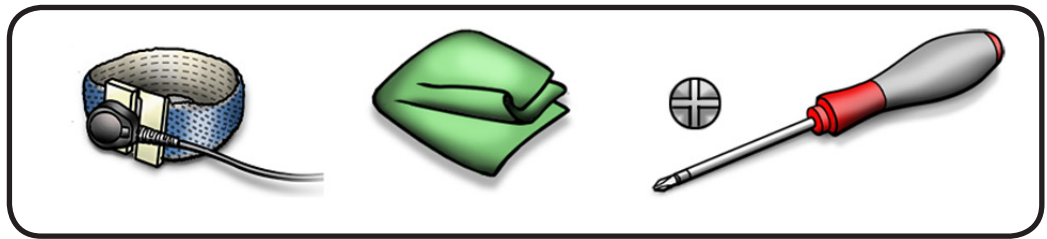

Removal

- 1 Loosen 2 captive screws.



- 2 Lift out bracket.

Replacement Note: Make sure 2 rubber grommets are included in bracket before installing it.

Note: The top of the hard drive bracket has a long EMI gasket (not shown). Do not remove it.





Hard Drive

First Steps

Remove:

- Bottom case
- Hard drive bracket



Caution: Make sure data is backed up before removing the hard drive.

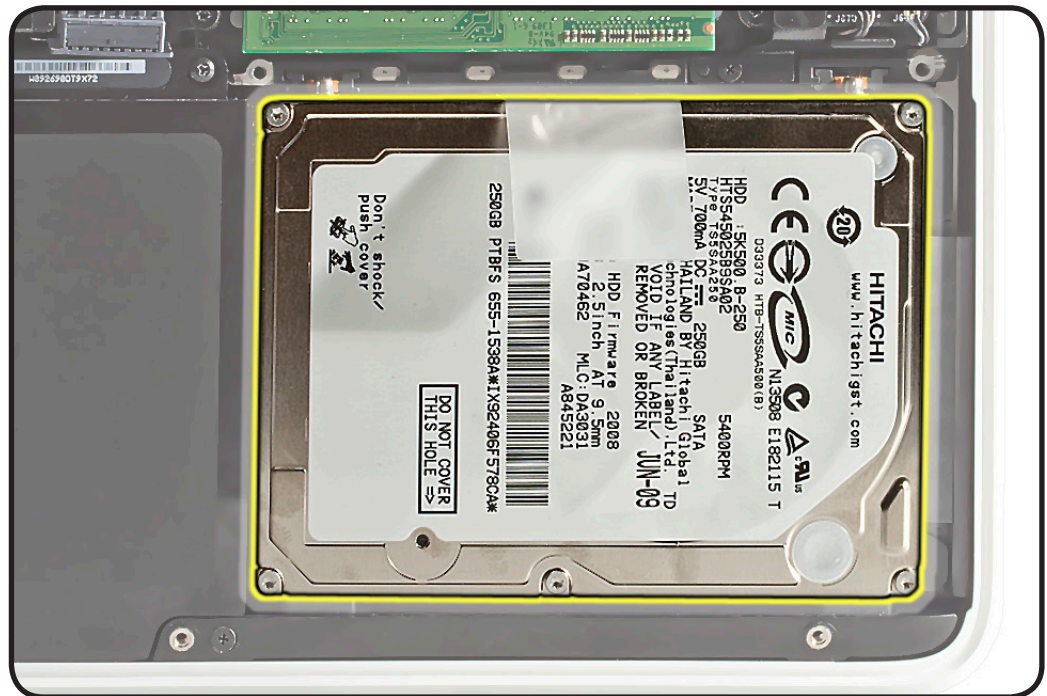

Before you begin this procedure, disconnect the battery from the logic board. Failure to do so could damage the computer.

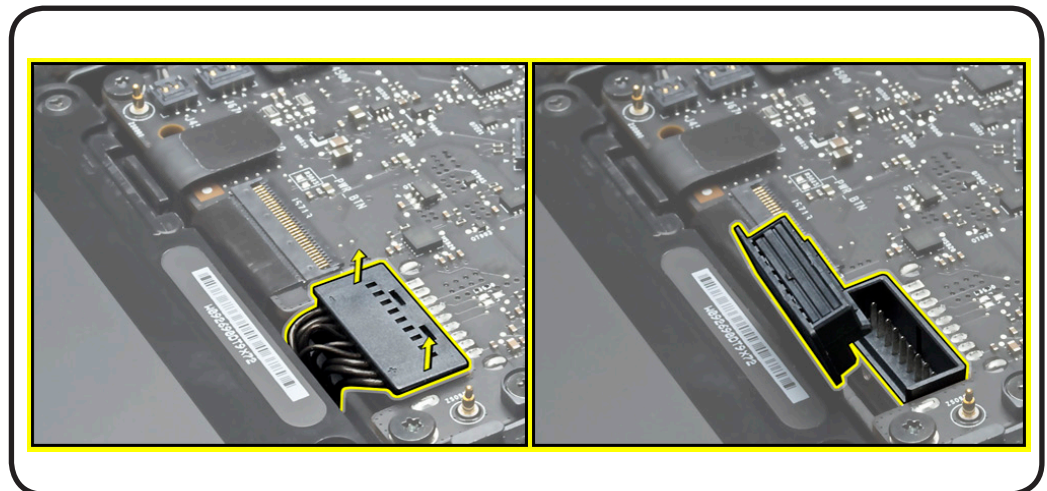



Tools

- Clean, soft, lint-free cloth
- ESD wrist strap and mat
- Magnetized Phillips #00 screwdriver
- Torx T6 screwdriver
- Black stick

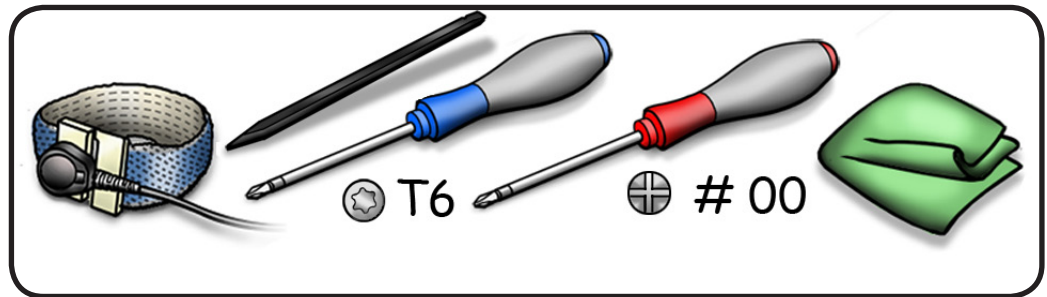

Removal

- 1 Make sure hard drive bracket is removed.
- 2 To prevent strain on hard drive flex cable,
 - remove 3.12-mm (922-9211) screw
 - disconnect cable from logic board

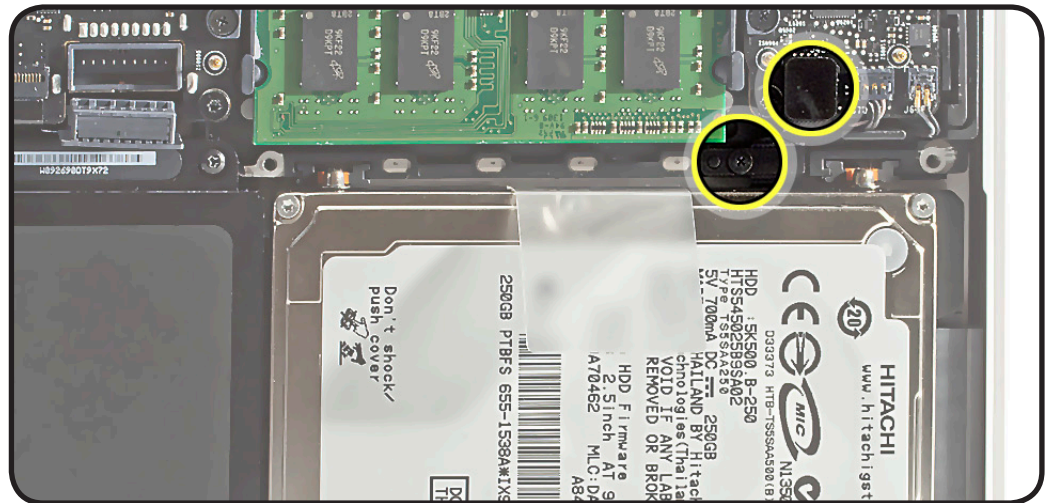

- 3 Use pull tab to tilt hard drive out.





- 4 Hold hard drive by the sides only.
- 5 Disconnect hard drive connector.

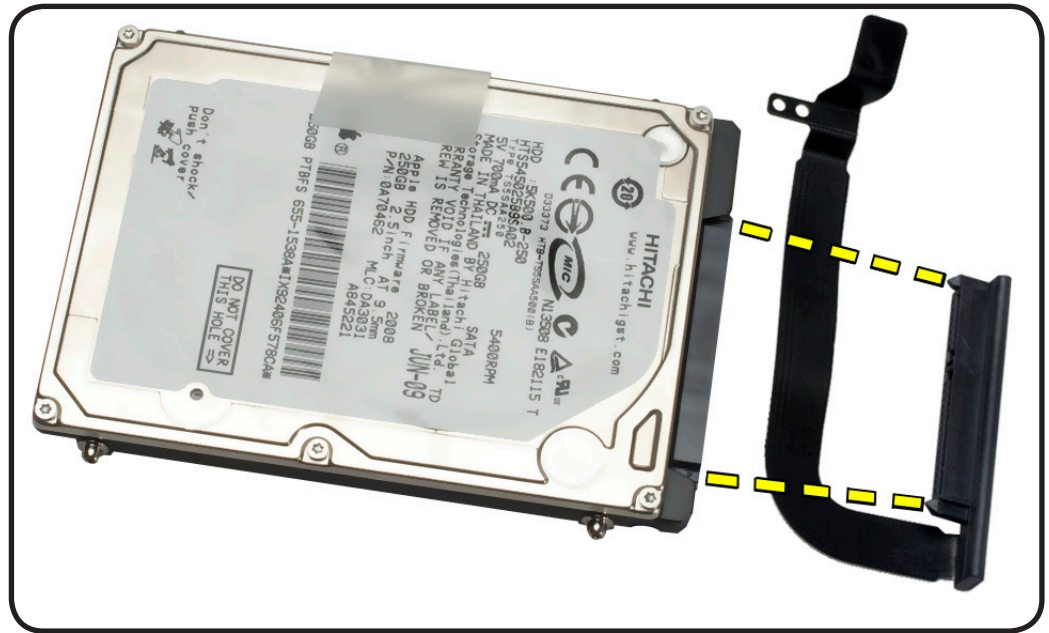

- 6 Follow safe handling:
 - Do not press drive



- Do not touch connector

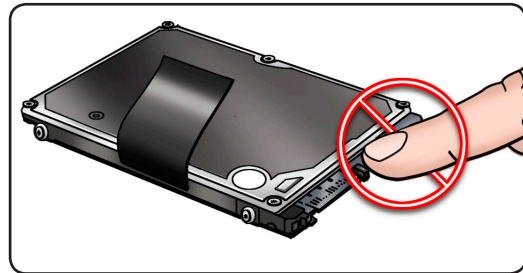

- Do not touch circuitry

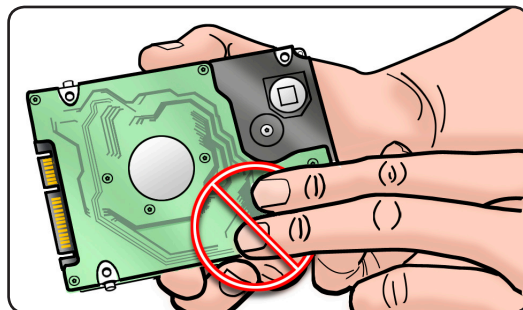



Replacement

- 1 Make sure 4 rubber grommets are included in top case before installing hard drive.

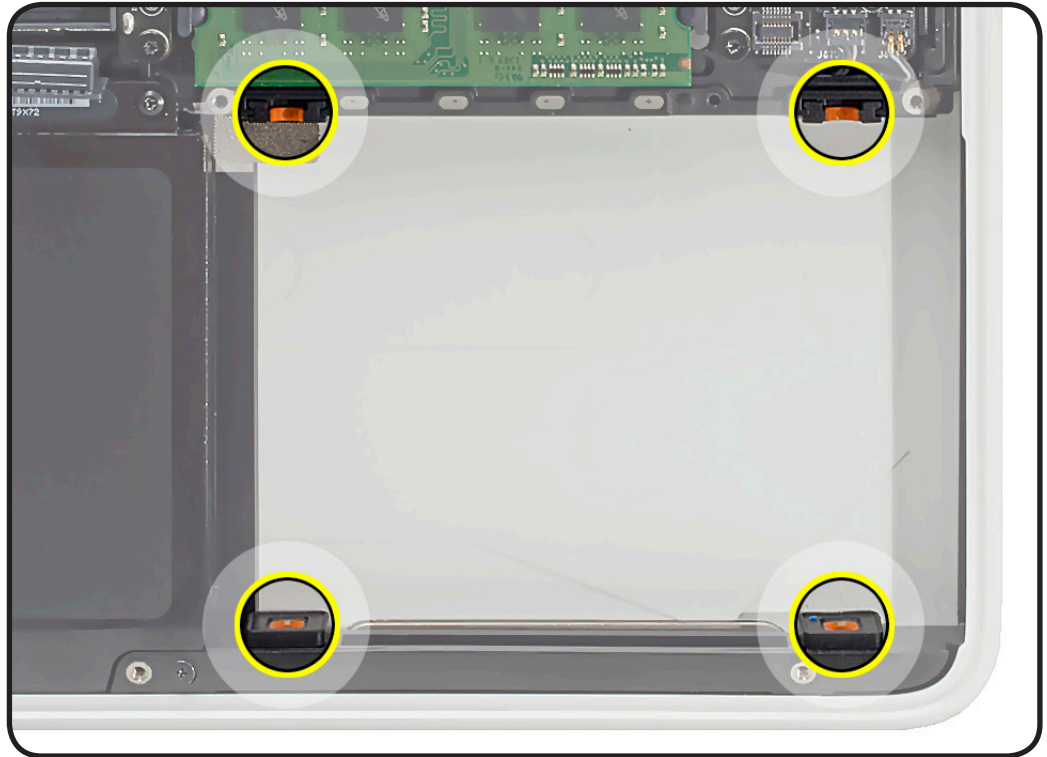

- 2 Make sure 4 Torx T6 mounting screws (not available separately) are installed on drive.

If replacement drive does not have mounting screws, transfer them from old drive.

- 3 Attach connector, and tilt hard drive into front of top case.
- 4 Connect hard drive connector cable to logic board and install screw.





Reinstalling Software that Came with the Computer

Use the software install discs that came with the computer to reinstall Mac OS X and any applications that came with the computer.

Important: Apple recommends backing up data on the hard disk before restoring software. Back up essential files before installing Mac OS X and other applications. Apple is not responsible for any lost data.

For more details, refer to <http://support.apple.com/kb/HT3910>.



Hard Drive Connector Cable

First Steps

Remove

- Bottom case
- Hard drive bracket
- Hard drive

Refer to [Hard Drive](#) for details.





Hard Drive Grommets

First Steps

Remove:

- Bottom case
- Hard drive bracket
- Hard drive



Caution: Make sure data is backed up before removing hard drive.



Before you begin this procedure, disconnect the battery from the logic board. Failure to do so could damage the computer.

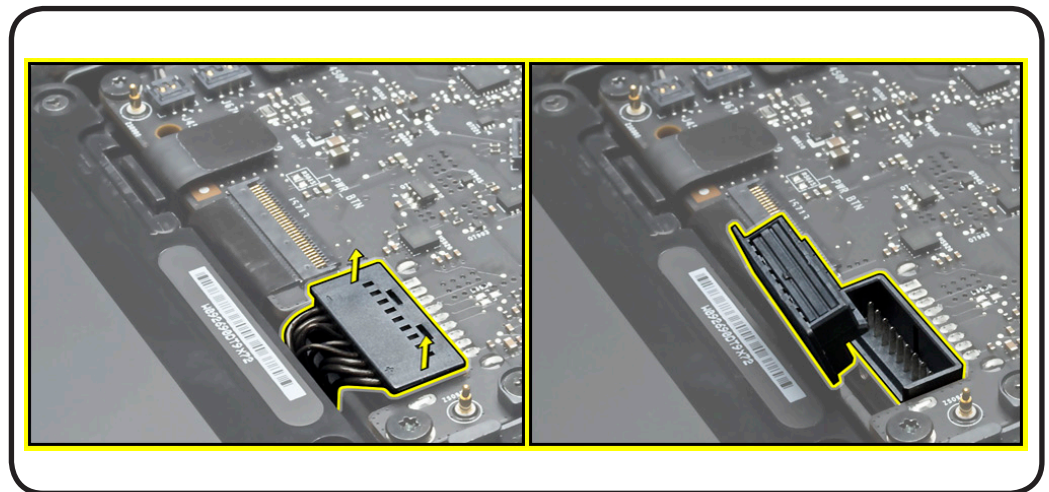



Tools

- Clean, soft, lint-free cloth
- ESD wrist strap and mat
- Black stick

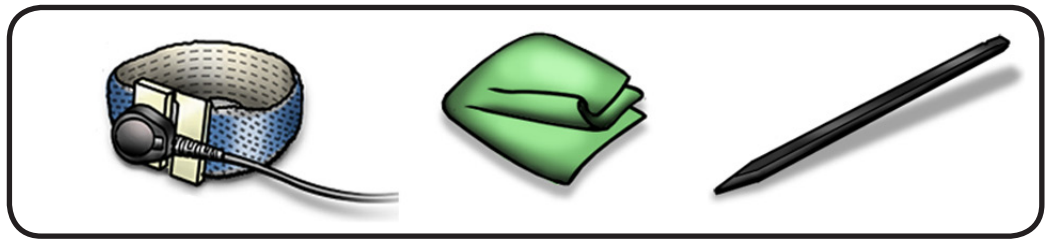

Removal

Important: Grommets at the front of the hard drive bay are securely adhered to the top case and should not need replacement.

Pry out rubber grommet from the rear drive bay.

Replacement Note: Install grommet so wider rubber flange faces hard drive.

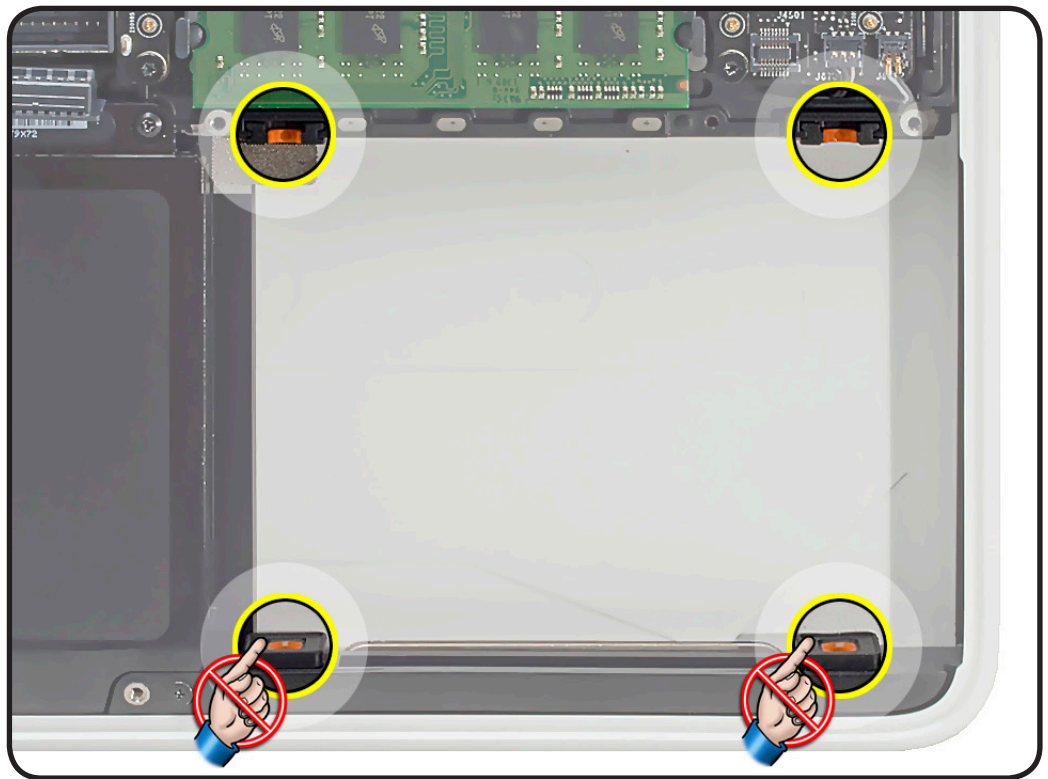



Memory

First Steps

Remove:

- Bottom case

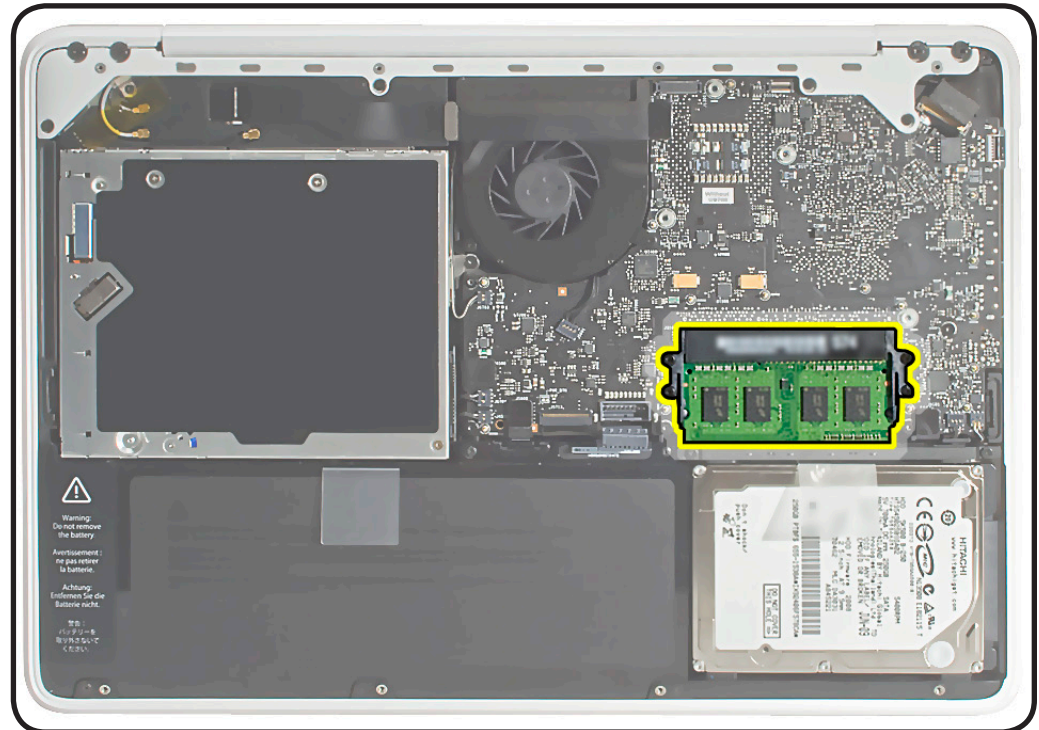

Before you begin this procedure, disconnect the battery from the logic board. Failure to do so could damage the computer.

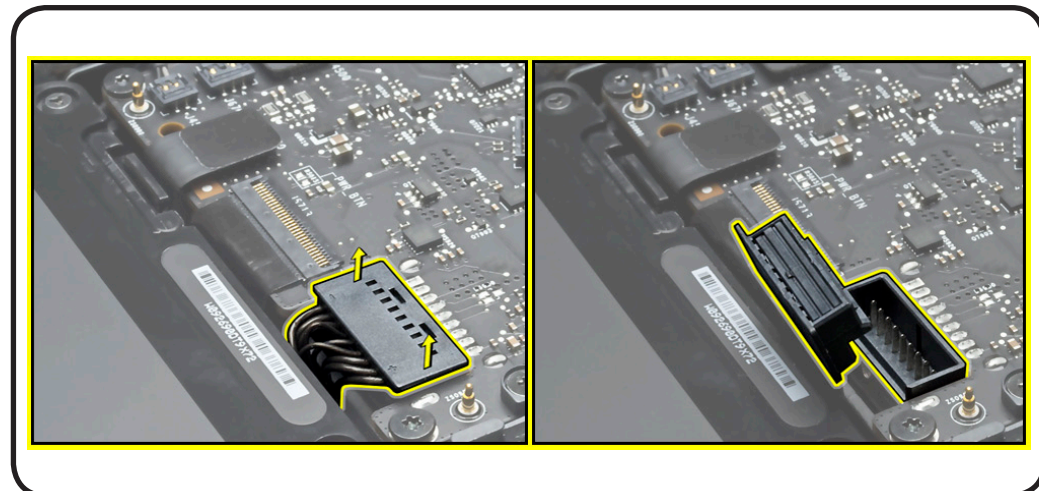



Tools

- Clean, soft, lint-free cloth
- ESD wrist strap and mat

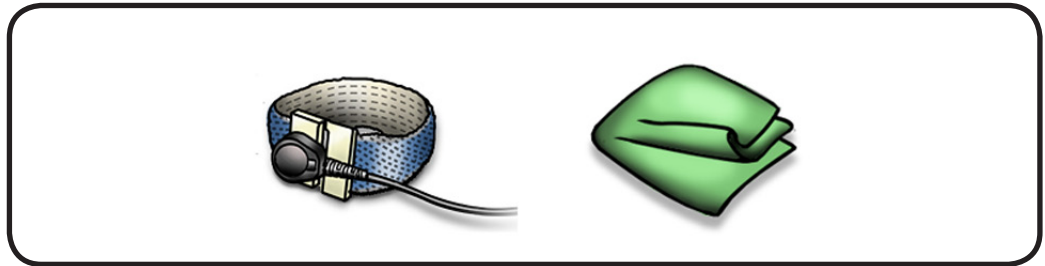

Removal

Memory cards must be:

- 30 mm (1.18 inch) or smaller
- 1 GB or 2 GB
- 204-pin
- PC3-8500 DDR3, 1066 MHz RAM

This computer comes with a minimum of 2 GB of 1066 MHz Double Data Rate 3 (DDR3) Synchronous Dynamic Random-Access Memory (SDRAM) installed. It has two slots that can accept SDRAM Small Outline Dual Inline Memory Modules (SO-DIMMs). The slots are stacked on the logic board under the bottom case. For best performance, memory should be installed as pairs with an identical memory card in each slot. The maximum amount of memory for this computer is 4 GB, with a 2 GB DIMM installed in each slot.

- 1 Press out 2 ejection levers until the card tilts up completely,

The card tilts up at an angle. Before removing the card, make sure you see the half-circle notches. If not, press the ejection levers again.

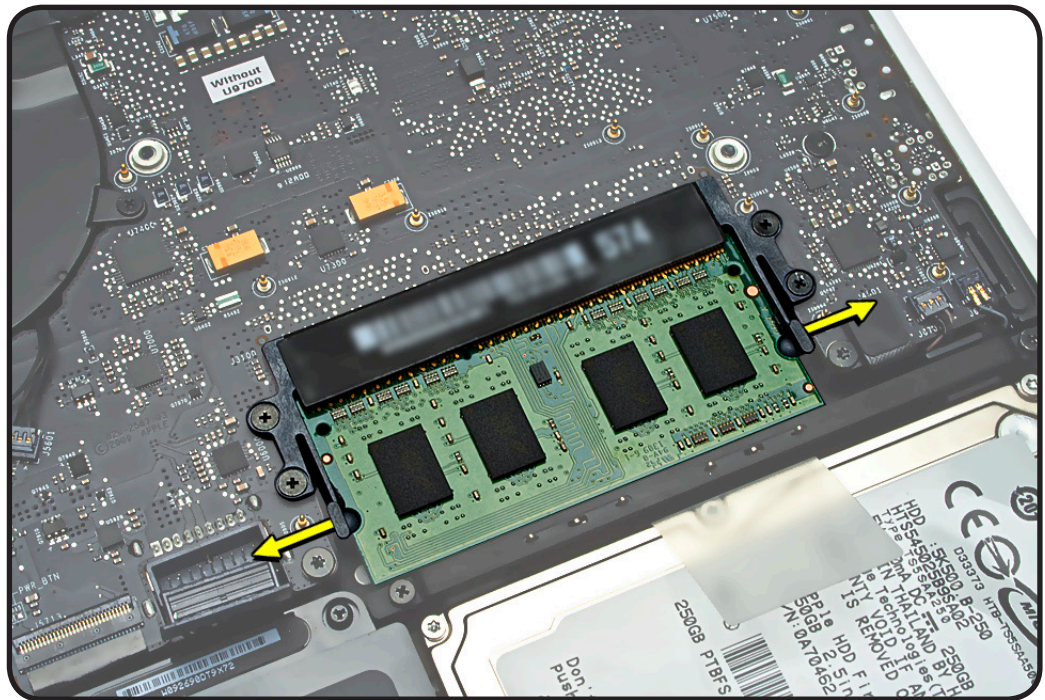



- 2 Pull out the card.
- 3 Hold the card by the edges.
- 4 Do not touch the gold connectors.

Note: New memory cards might have a harmless white residue on the gold connectors.

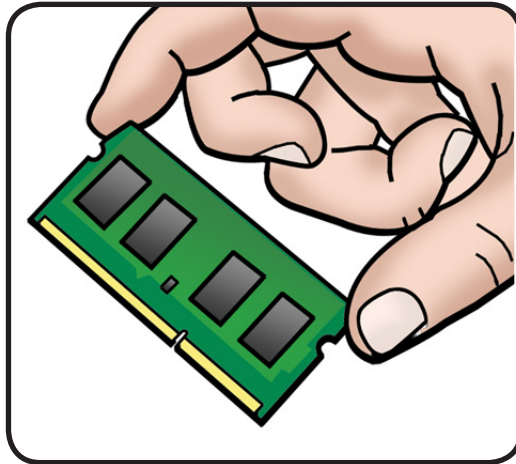

Replacement

- 1 Install cards at an angle. If installing just one card, install it in lower slot.

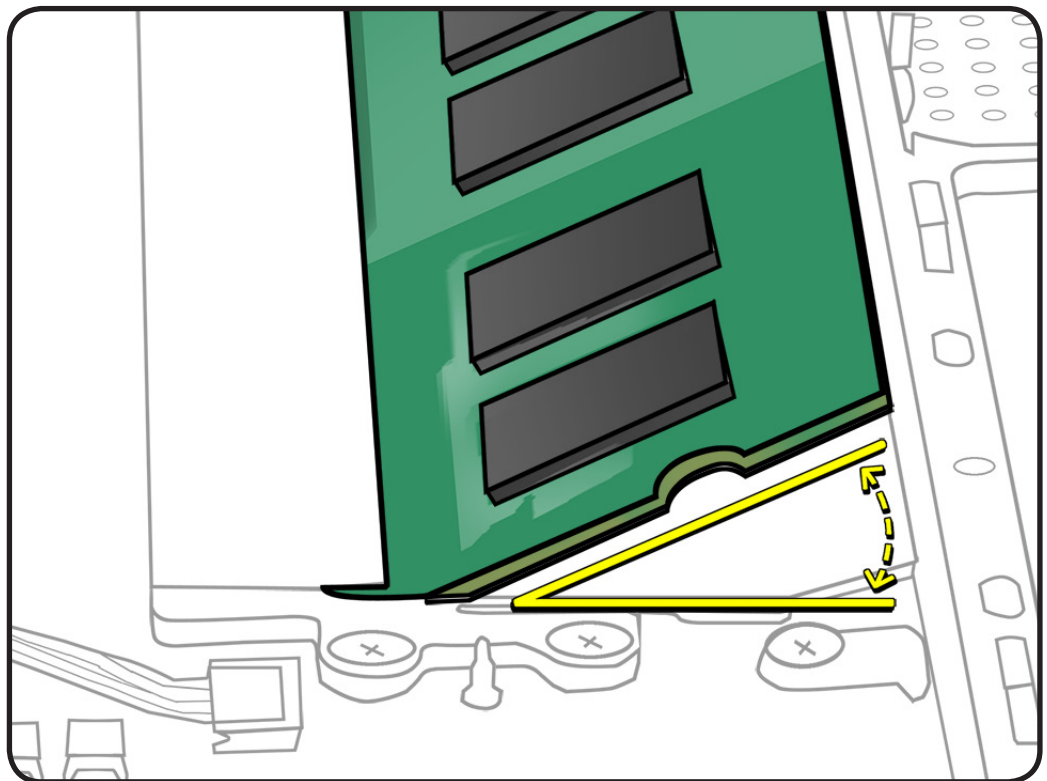



- 2 Press card down.
- 3 If you installed additional memory, check that computer recognizes it.

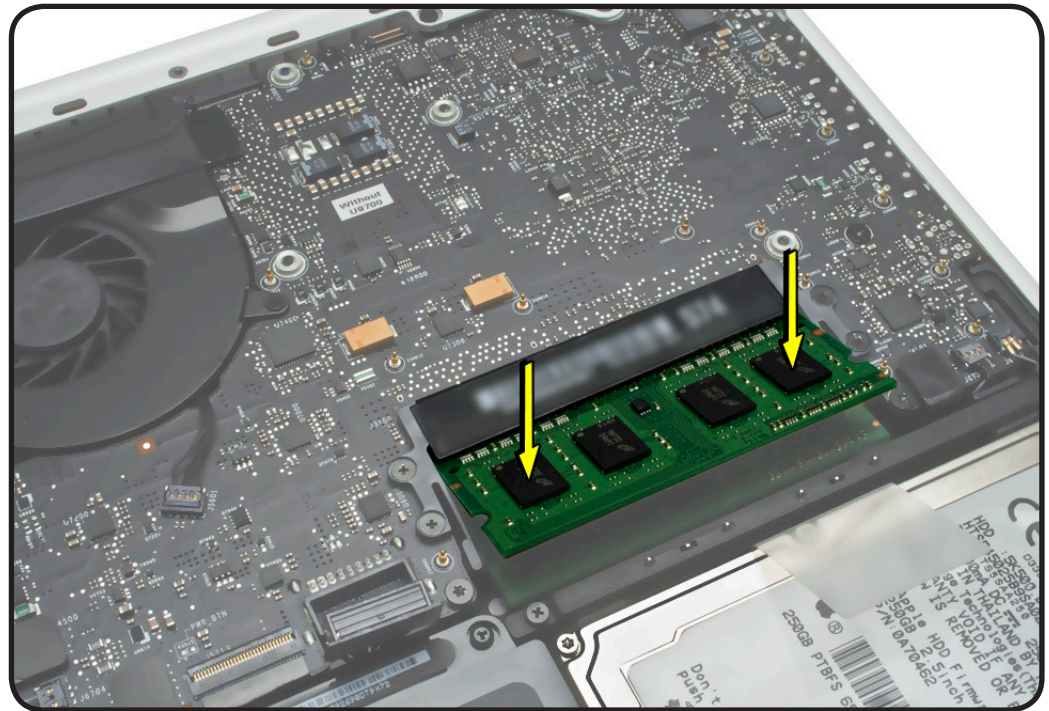



Fan

First Steps

Remove:

- Bottom case

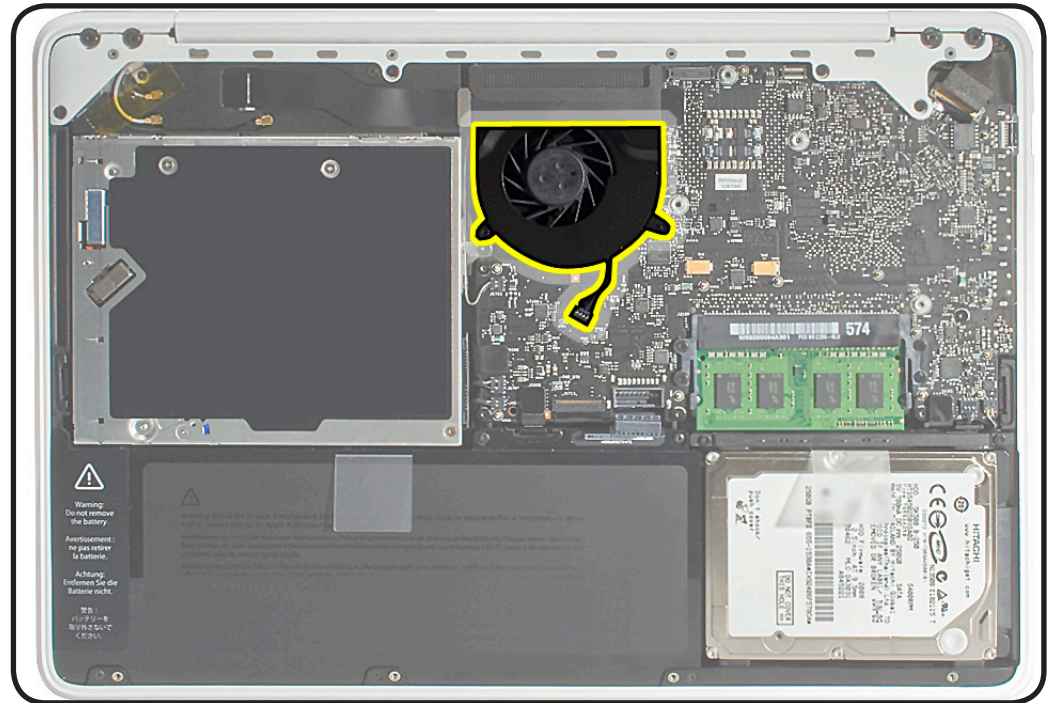

Before you begin this procedure, disconnect the battery from the logic board. Failure to do so could damage the computer.

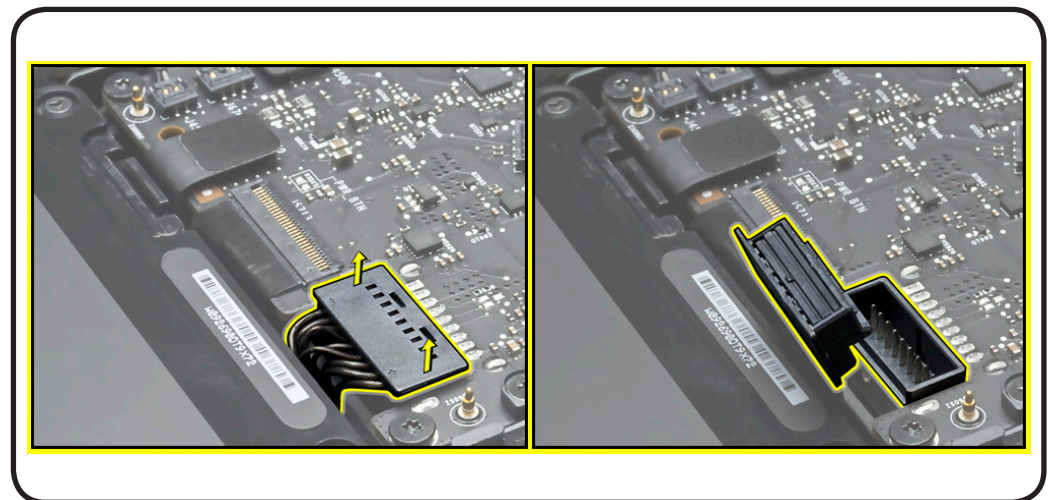



Tools

- Clean, soft, lint-free cloth
- ESD wrist strap and mat
- Magnetized Phillips #00 screwdriver
- Black stick

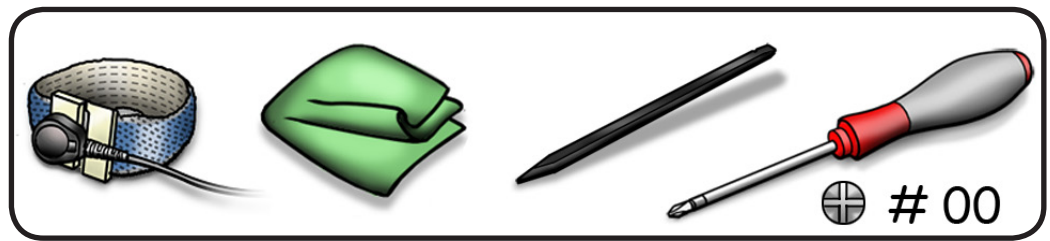

Removal

- 1** Disconnect AirPort/Bluetooth flex cable from logic board, and tilt up that end of cable.
- 2** Disconnect fan cable.
- 3** Remove screws:
 - 2 (5.28 mm) 922-9202
 - 1 (7.09 mm) 922-8645

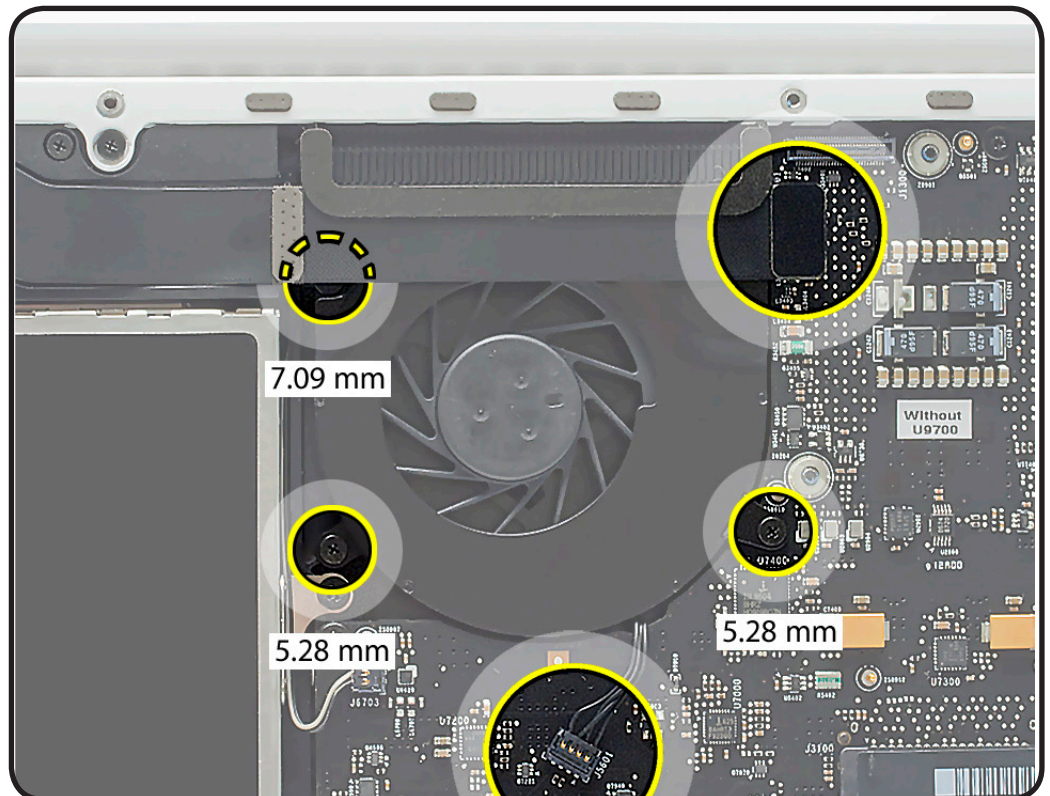



4 Tilt up fan.

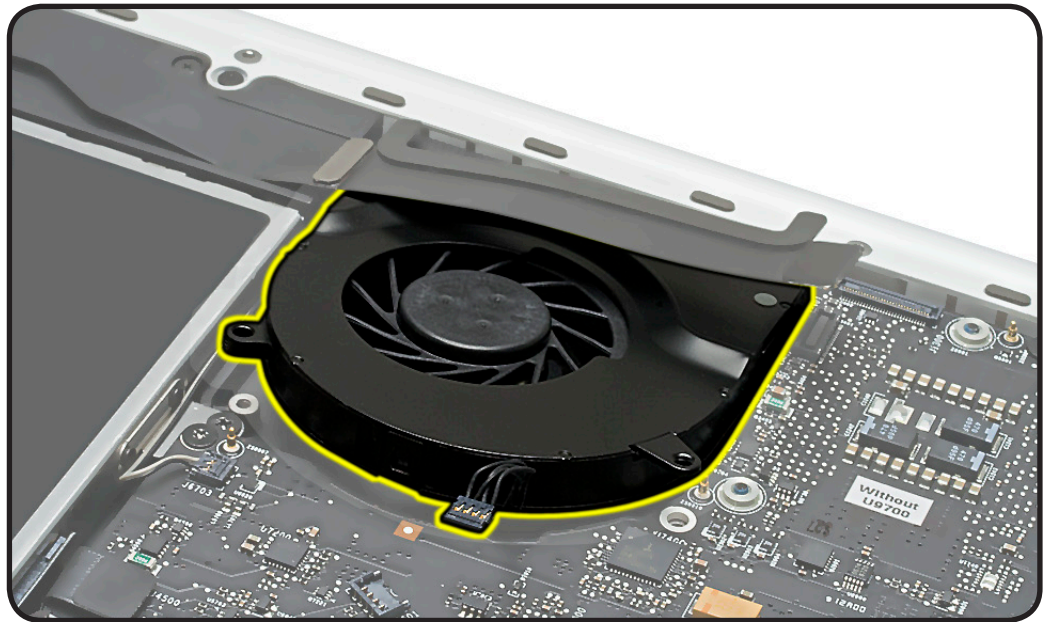



AirPort/Bluetooth Flex Cable

First Steps

Remove:

- Bottom case

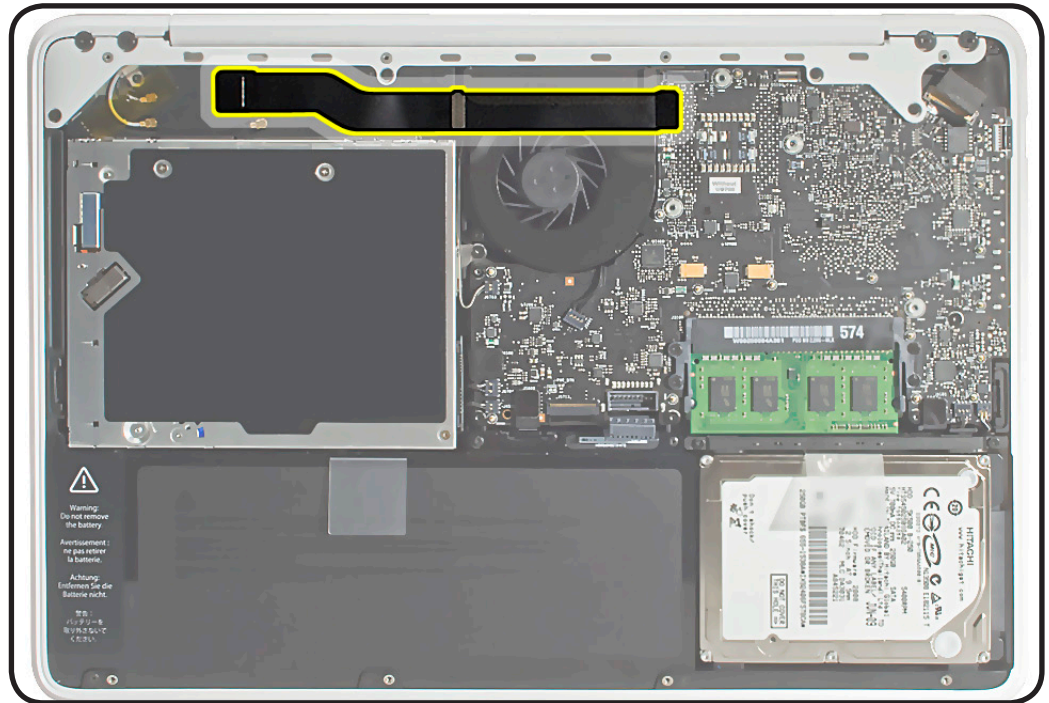

Before you begin this procedure, disconnect the battery from the logic board. Failure to do so could damage the computer.

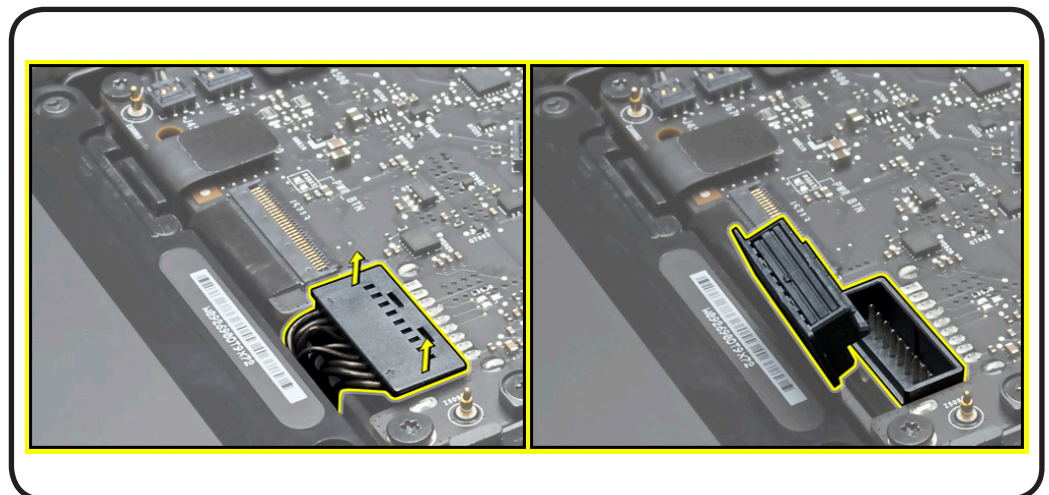



Tools

- Clean, soft, lint-free cloth
- ESD wrist strap and mat
- Black stick

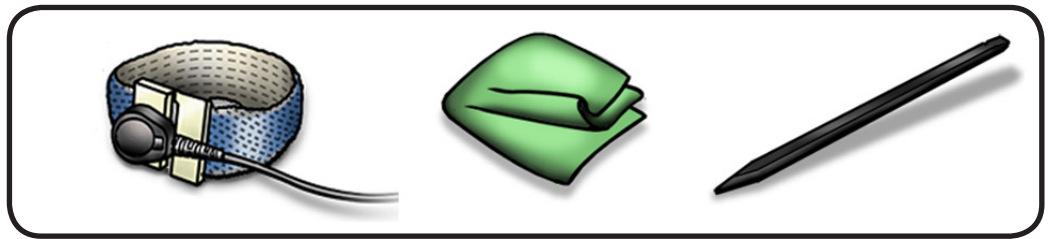

Removal

- 1 Disconnect AirPort/Bluetooth flex cable from speaker, and tilt up that end of cable.

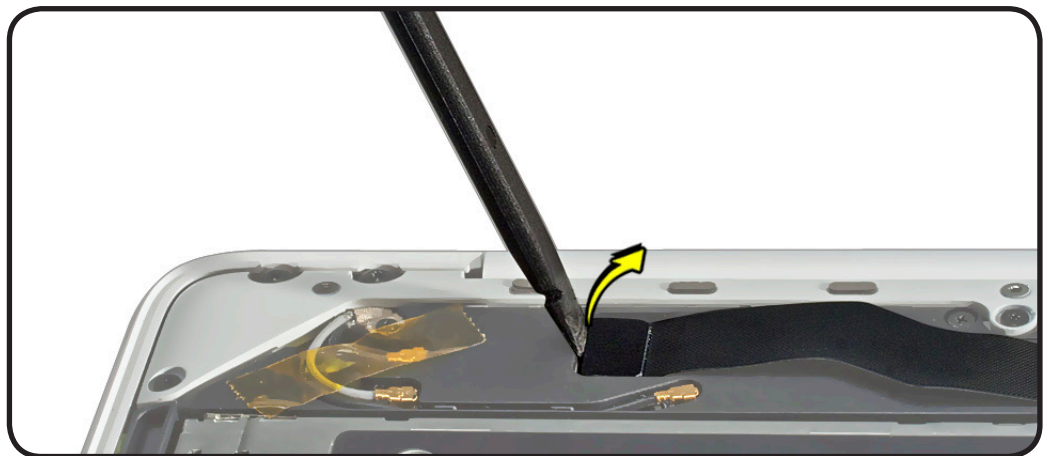

- 2 Disconnect other end of cable.

- 3 Carefully pull up center of cable from adhesive on speaker housing.

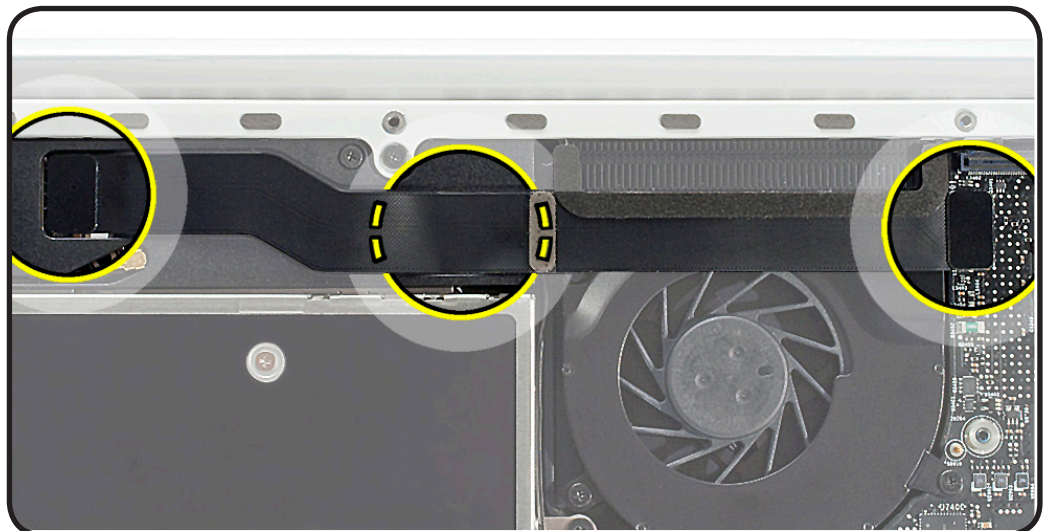



Rear Vent

First Steps

Remove:

- Bottom case

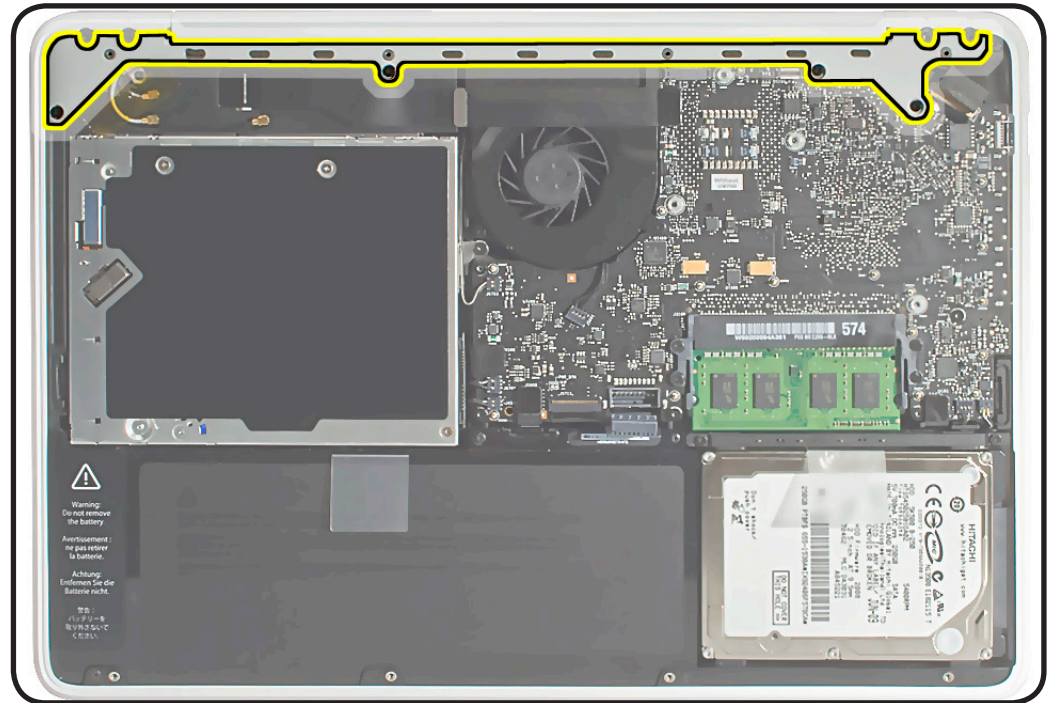

Before you begin this procedure, disconnect the battery from the logic board. Failure to do so could damage the computer.

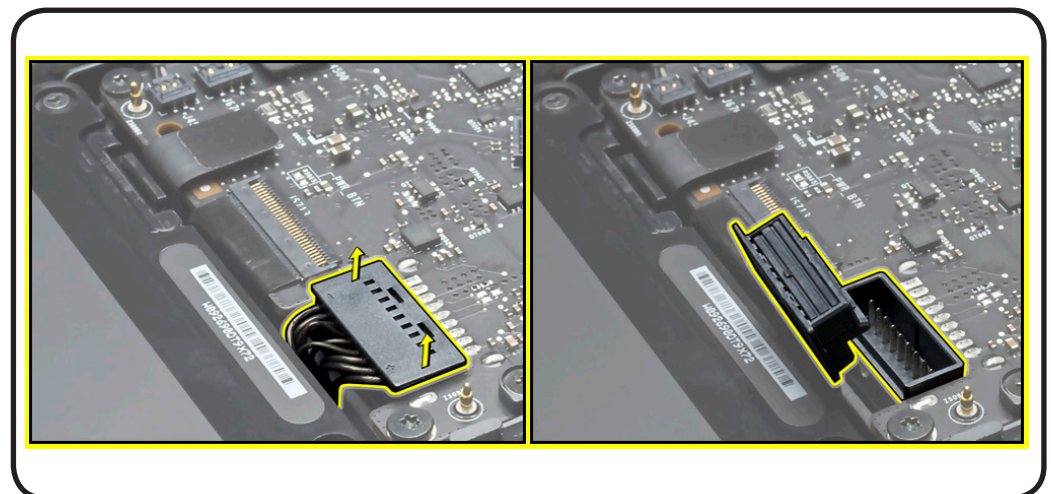



Tools

- Clean, soft, lint-free cloth
- ESD wrist strap and mat
- Magnetized Phillips #00 screwdriver
- Torx T8 screwdriver
- Foam wedge fixture
- Torque driver, optional

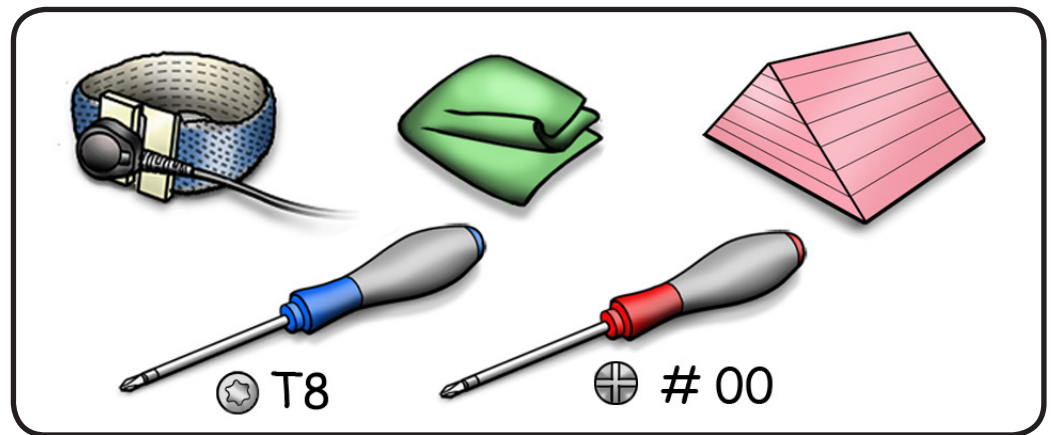

Removal

- 1 Open display and place it on foam wedge fixture.

Note: If fixture unavailable, place display (open to 90+ degrees) so it safely hangs over a clean, padded table edge. The back of the display housing should face you, and the LCD panel must be protected from scratches by a clean, soft, lint-free cloth.

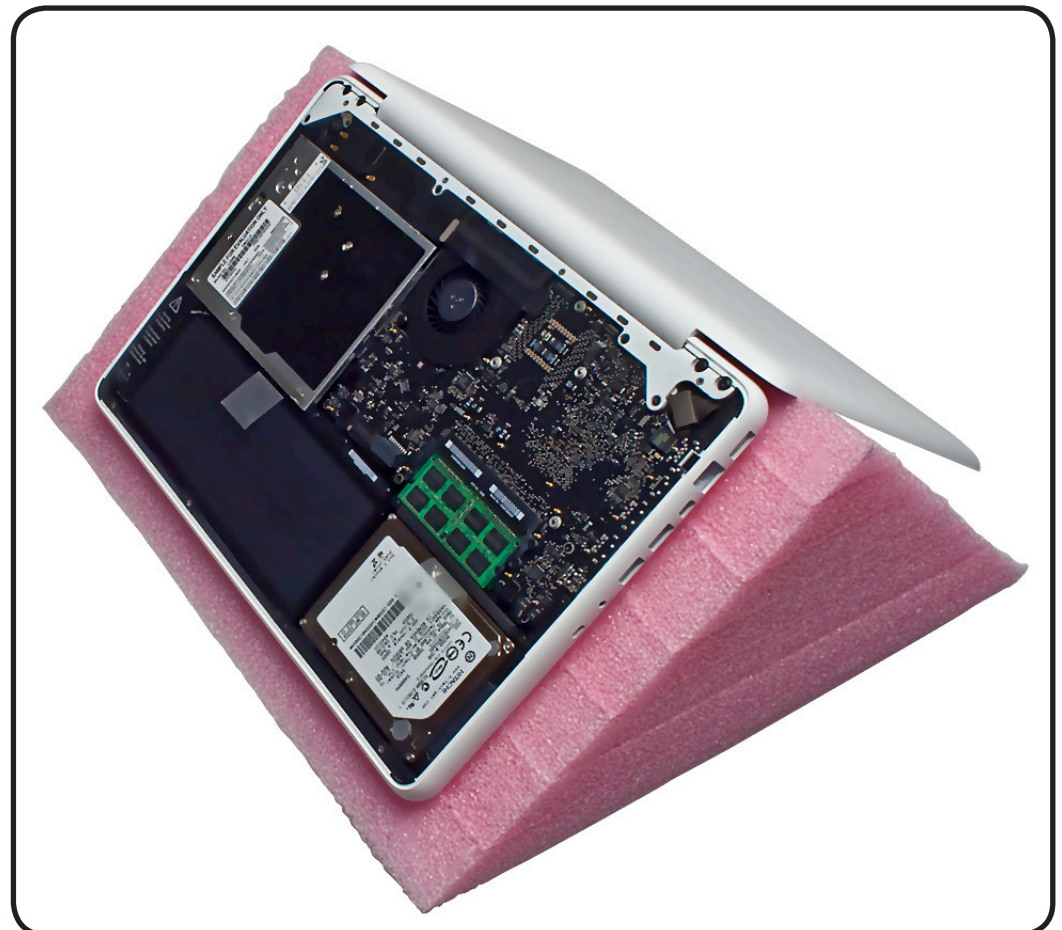



- 2** Remove 8 screws:
- 1 (4 mm) red locktite 922-9443 #00 Phillips
 - 3 (5.28 mm) 922-9202 #00 Phillips
 - 4 (9.92 mm) 922-9210 T8

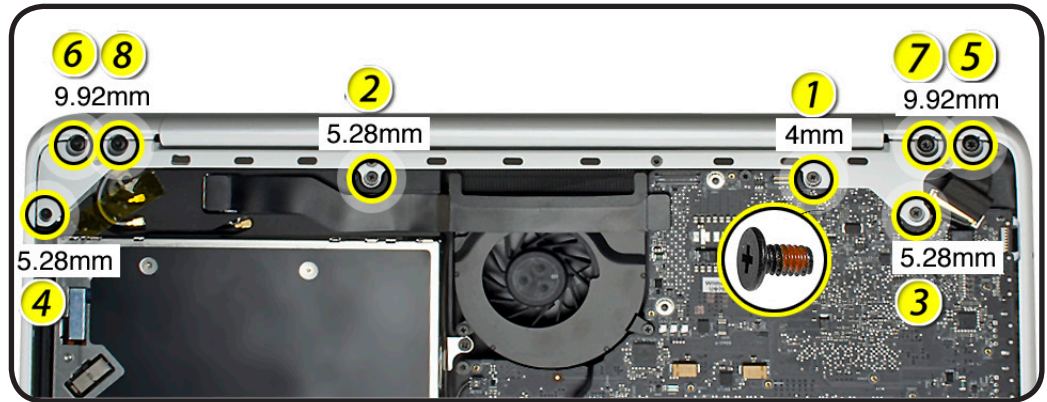

Replacement Note:
Install screws in the order shown.

Replacement Note:
For Torx screws 5-8 use a torque driver, if available, to tighten to 4.3 ± 0.17 inch pounds (5.0 ± 0.2 Kgf-cm).



Important: Replace screws like-for-like. The screw in location 1, shown above, differs depending on the computer's manufacturing code. Replace like-for-like, as indicated in this table:

- 3** Lift out rear vent

	4 mm with red locktite	922-9443	Product serial number includes: <ul style="list-style-type: none"> • 45905 to 45913 or • I9905 to I9913 or • IQ905 to IQ913
	5.28 mm with blue locktite	922-9202	Product serial number includes something other than the ranges listed above



Rear Speaker

First Steps

Remove:

- Bottom case
- Rear vent

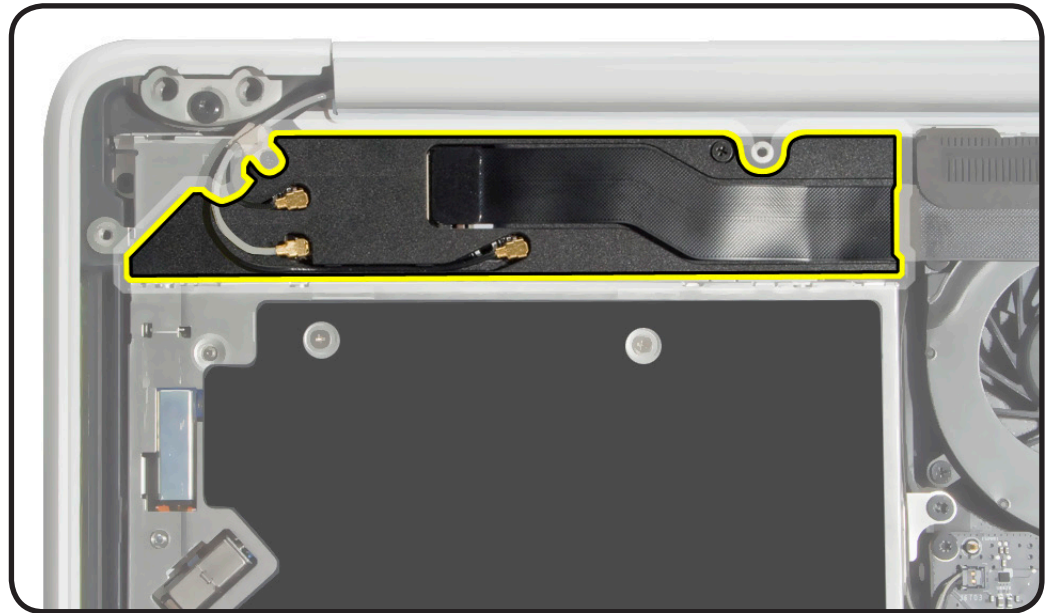

Before you begin this procedure, disconnect the battery from the logic board. Failure to do so could damage the computer.

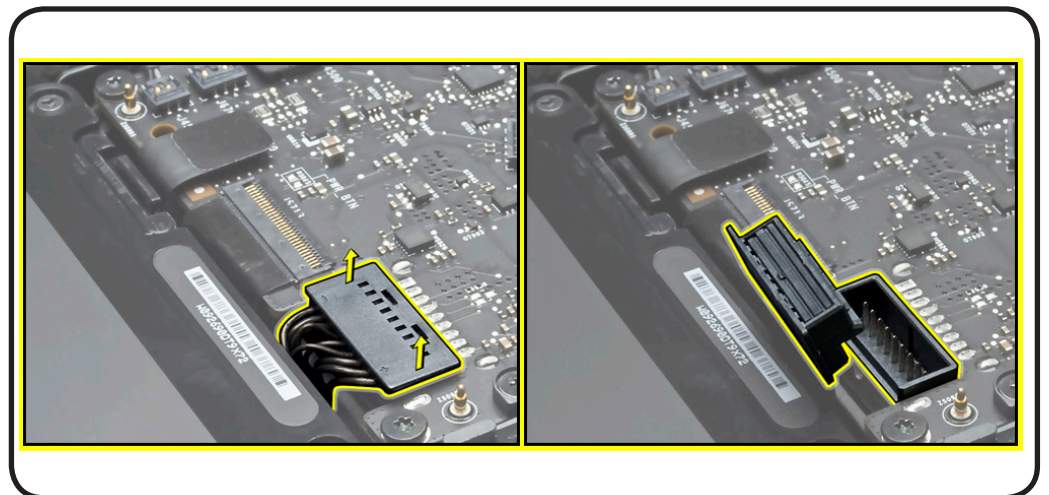



Tools

- Clean, soft, lint-free cloth
- ESD wrist strap and mat
- Magnetized Phillips #00 screwdriver
- Magnetized Phillips #000 screwdriver
- Black stick
- Needle-nose pliers

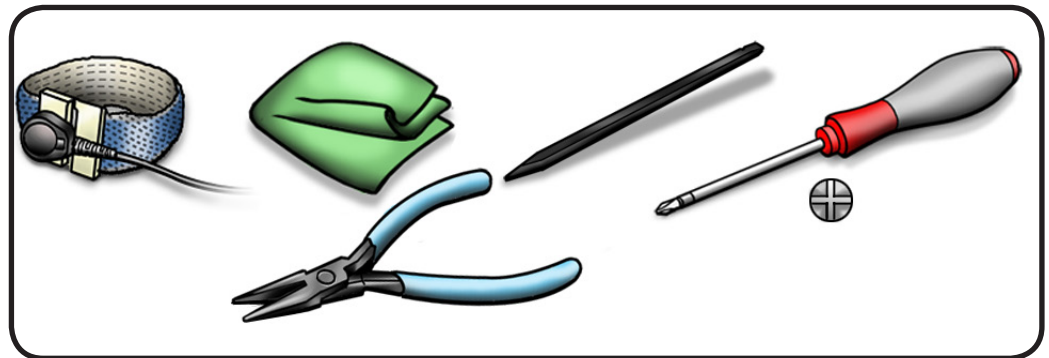

Removal

- 1 Use fingernails or needle-nose pliers to grasp metal connectors and disconnect
 - 2 AirPort antenna cables
 - 1 Bluetooth cable



Caution: Lift connector **straight up** to disconnect and position connector **straight down** to reconnect.

- 2 If tight fit, use black stick to pry up Bluetooth cable from channel in speaker housing.

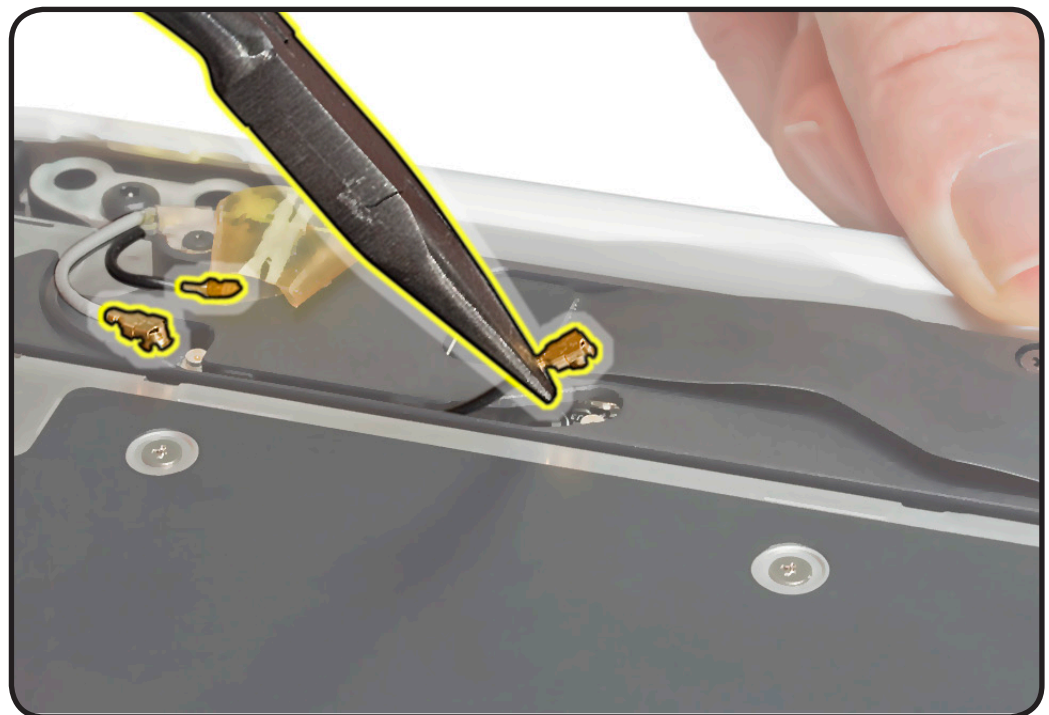



- 3** Use black stick to disconnect
- AirPort/Bluetooth flex cable
 - 2-pin cable from logic board

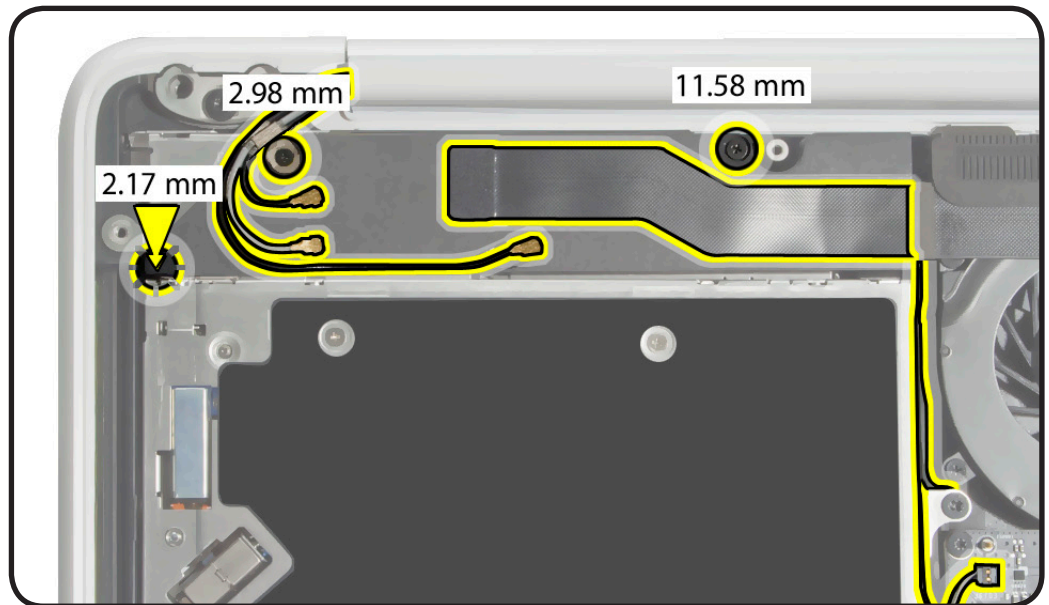

- 4** Remove 3 speaker housing screws:
- 11.58 mm (922-9201) at right
 - 2.98 mm (922-9200) at ground tab
 - 2.17 mm (922-9198) recessed vertically at left

- 5** Slide out rear speaker.

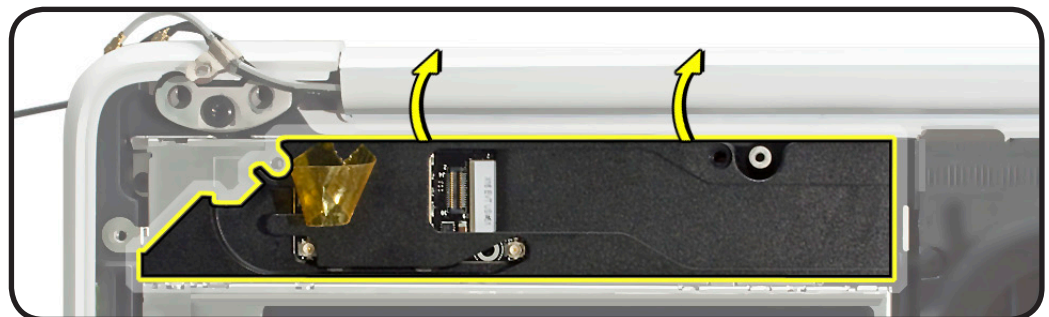



- 6 If replacing the speaker with a new one, remove 3 (3 mm) 922-9200 screws to transfer
- AirPort/Bluetooth card
 - bracket

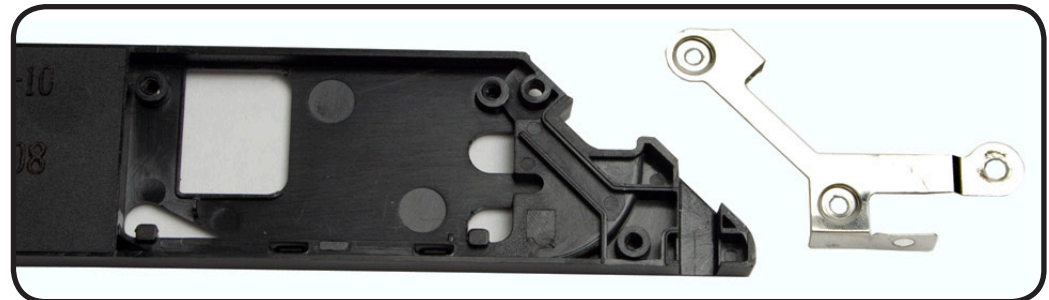
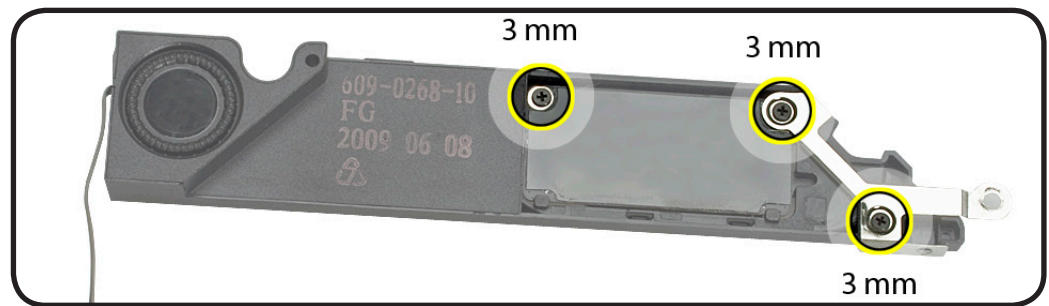



AirPort/Bluetooth Card

First Steps

Remove:

- Bottom case
- Rear vent
- Rear speaker

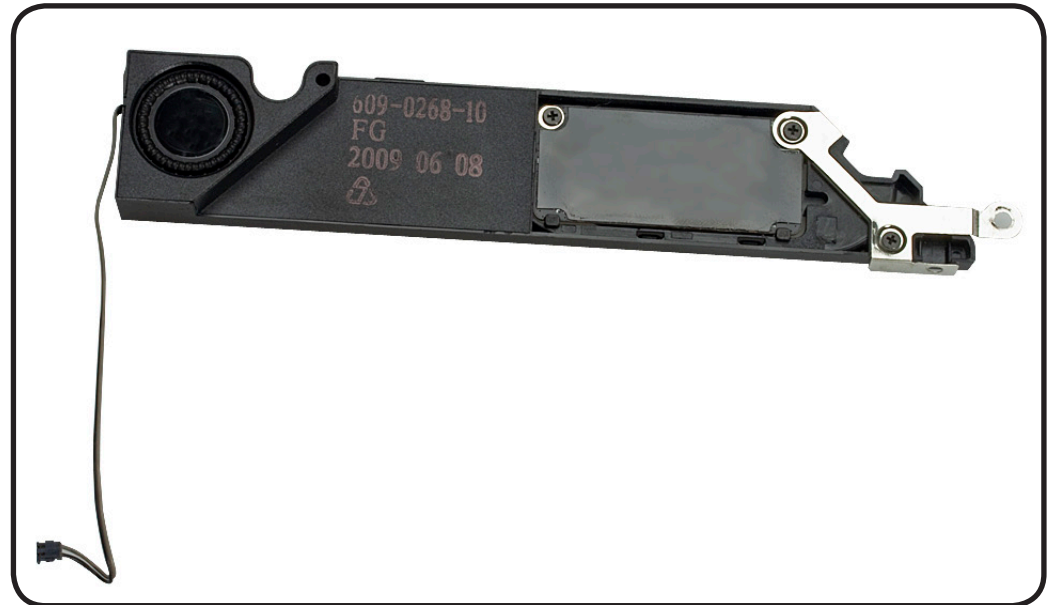

Before you begin this procedure, disconnect the battery from the logic board. Failure to do so could damage the computer.

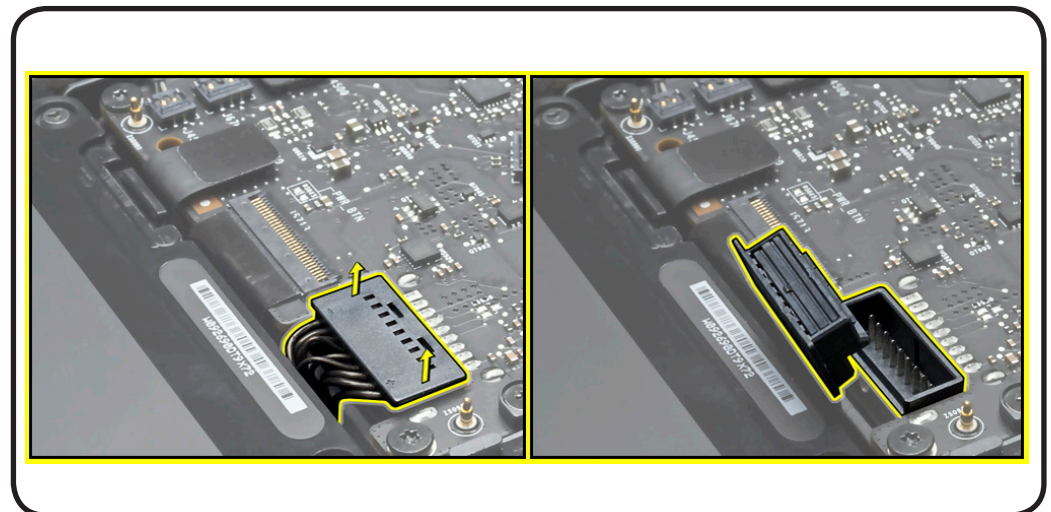



Tools

- Clean, soft, lint-free cloth
- ESD wrist strap and mat
- Magnetized Phillips #00 screwdriver

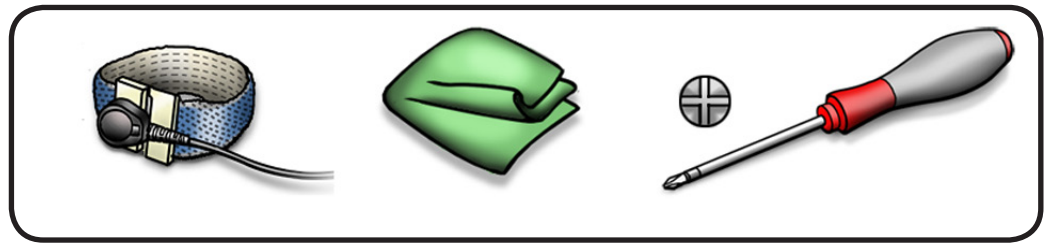

Removal

- 1 Remove 3 (3 mm) 922-9200 screws.

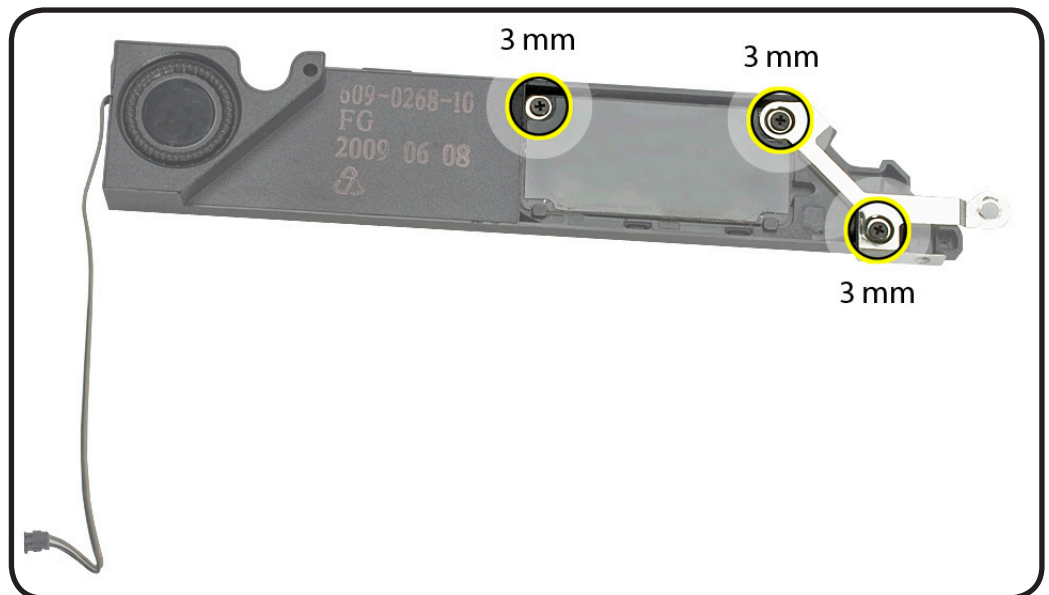

- 2 Tilt up card from tabs.

Replacement Note:
AirPort/Bluetooth card includes mylar panel.



- 3 Remove card.

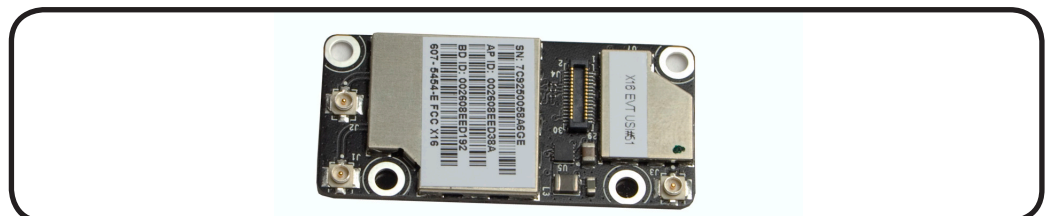



Optical Drive

First Steps

Remove:

- Bottom case
- Rear vent

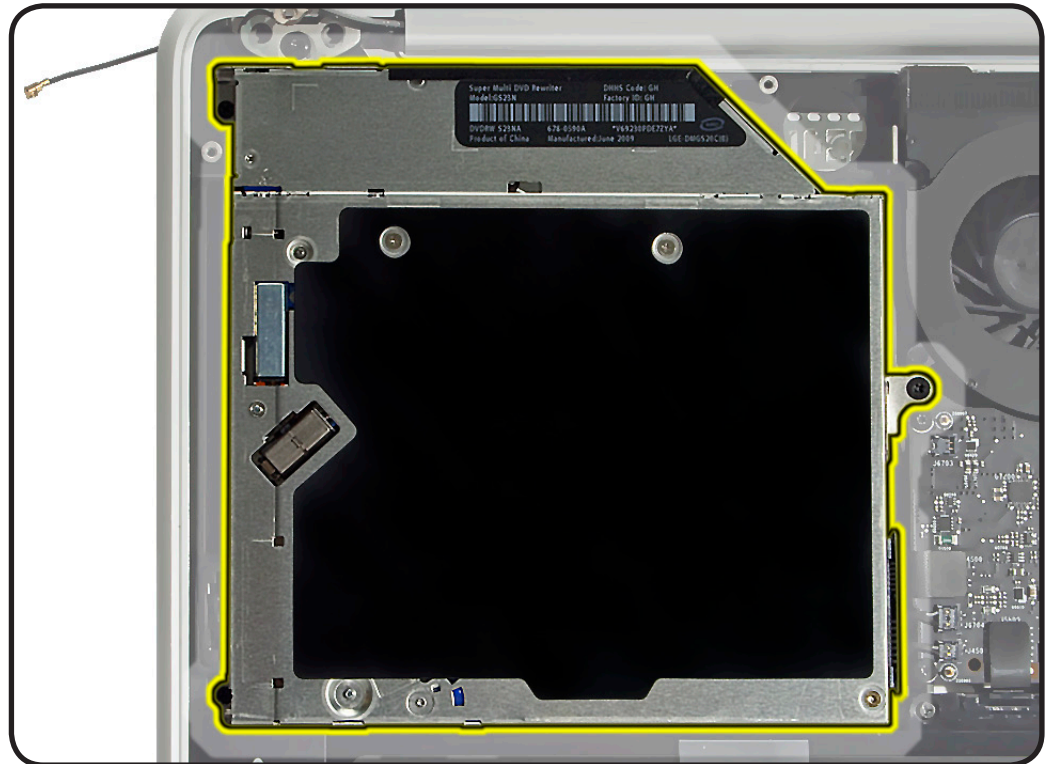

Before you begin this procedure, disconnect the battery from the logic board. Failure to do so could damage the computer.

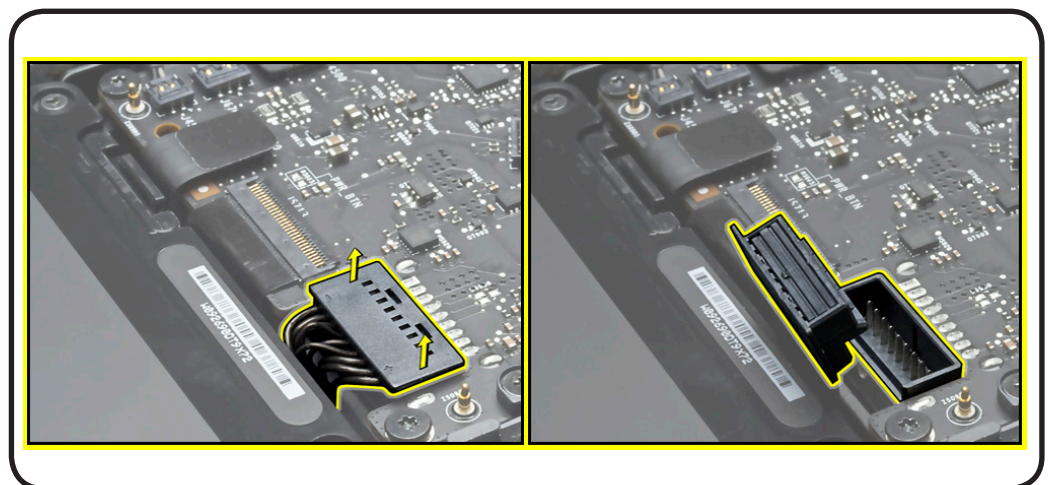



Tools

- Clean, soft, lint-free cloth
- ESD wrist strap and mat
- Magnetized Phillips #00 screwdriver
- Black stick

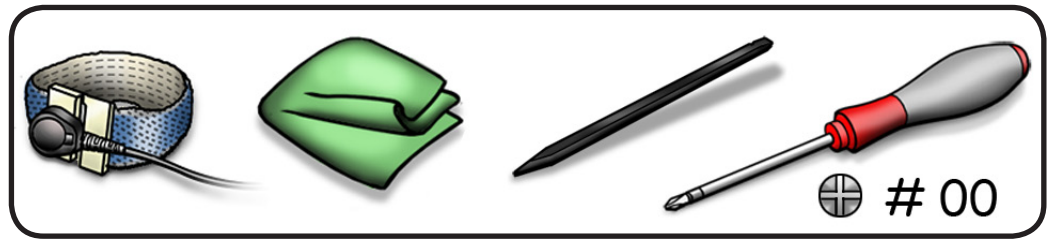

Removal

Important: Although the rear speaker can be removed, you can save time and reduce strain on the antenna cables by simply moving aside the attached speaker.

- 1 Remove 3 speaker screws and disconnect 2 cables.

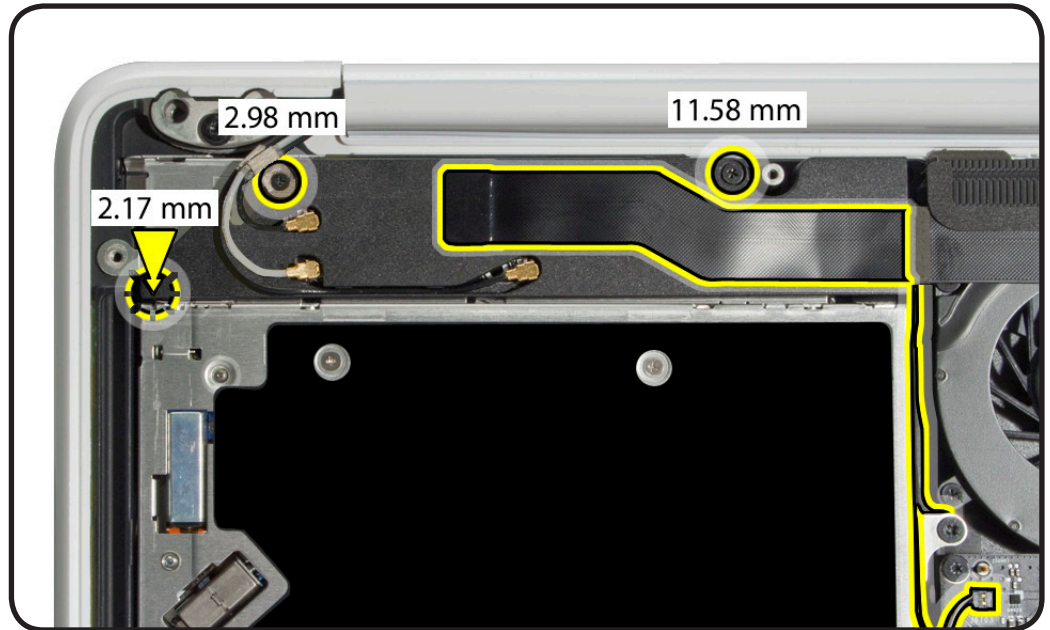

- 2 Without straining antenna cables, carefully flip over speaker.

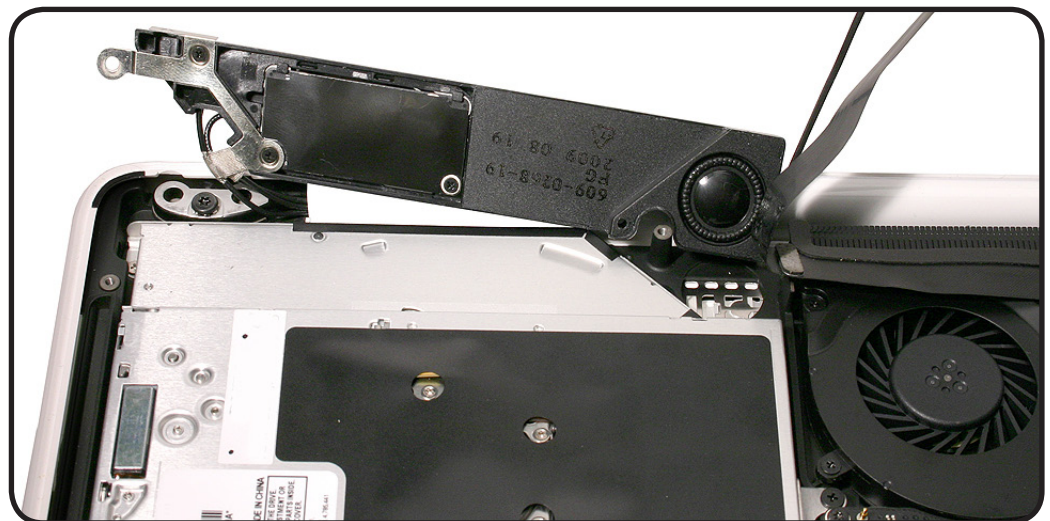



3 Use black stick to disconnect optical drive flex cable.

- 4** Remove 3 screws:
- 2 (2.49 mm) 922-9199 at left
 - 1 (4.49 mm) 922-9516 at right

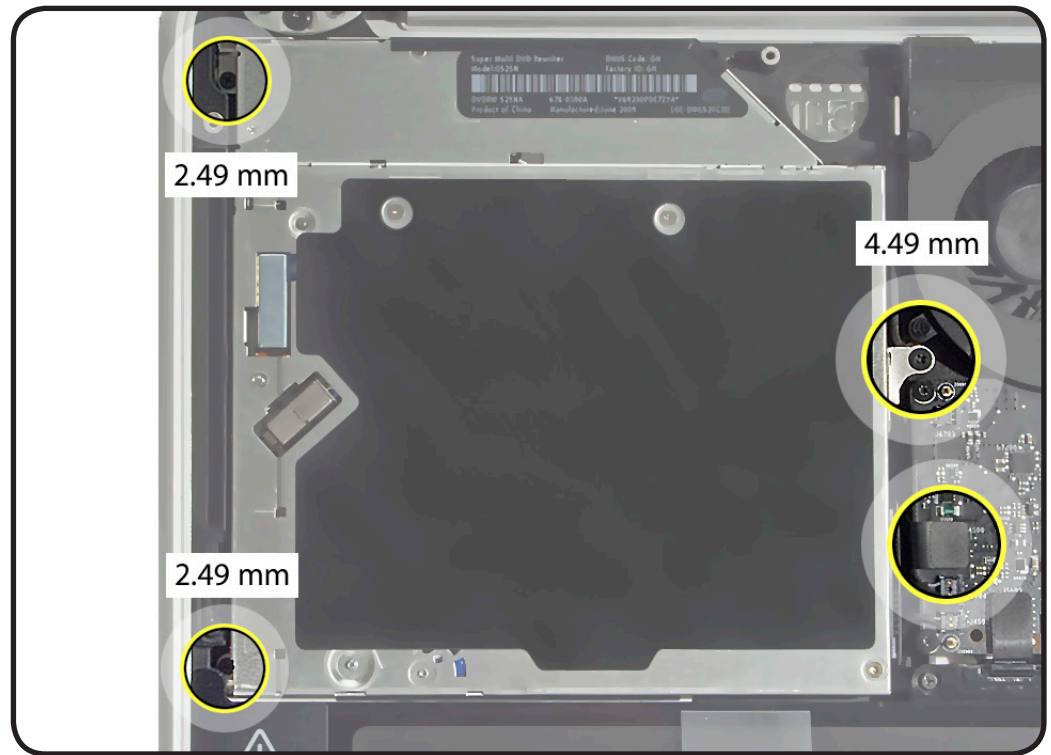

5 Tilt up optical drive.

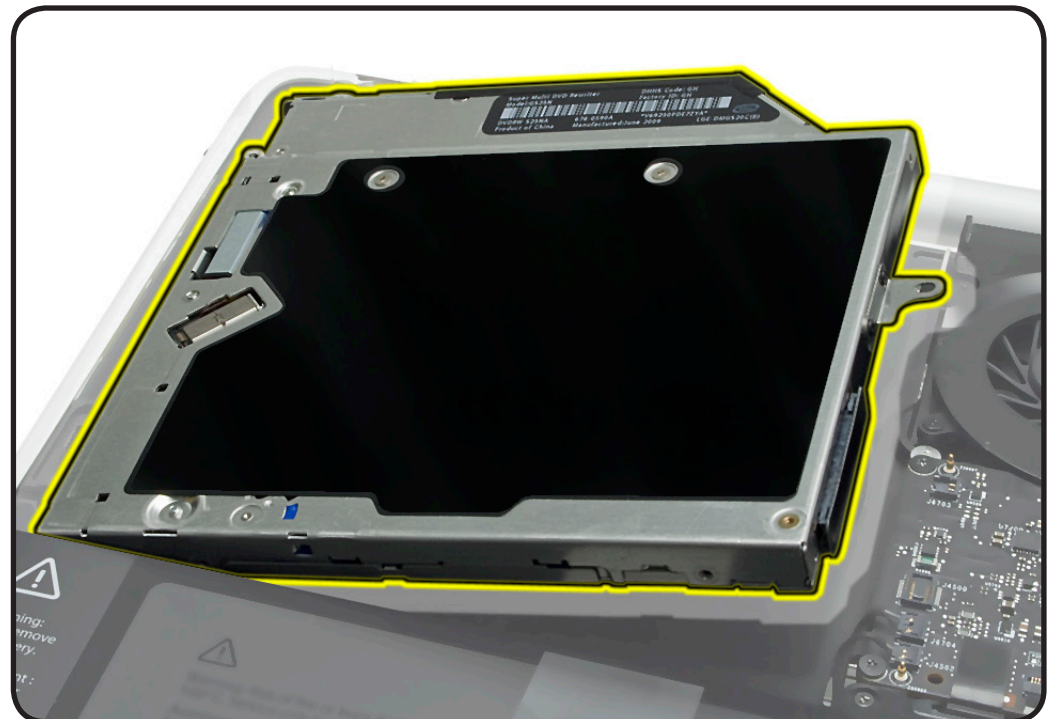



- 6 Caution:** The optical drive is very fragile. Handle by the sides only!

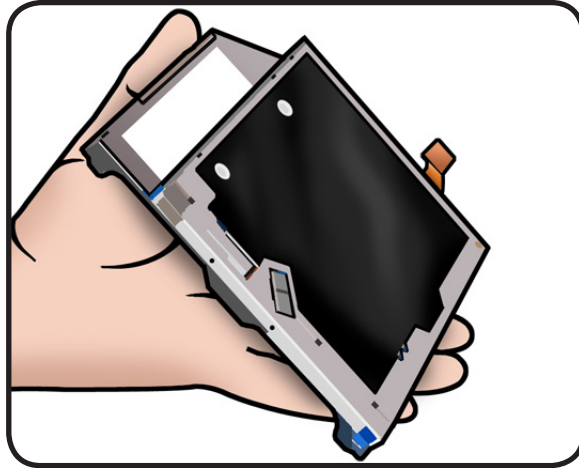



Optical Drive Flex Cable

First Steps

Remove:

- Bottom case
- Rear vent
- Rear speaker (optional)
- Optical drive



Caution: The optical drive is very fragile. Handle by the sides only.

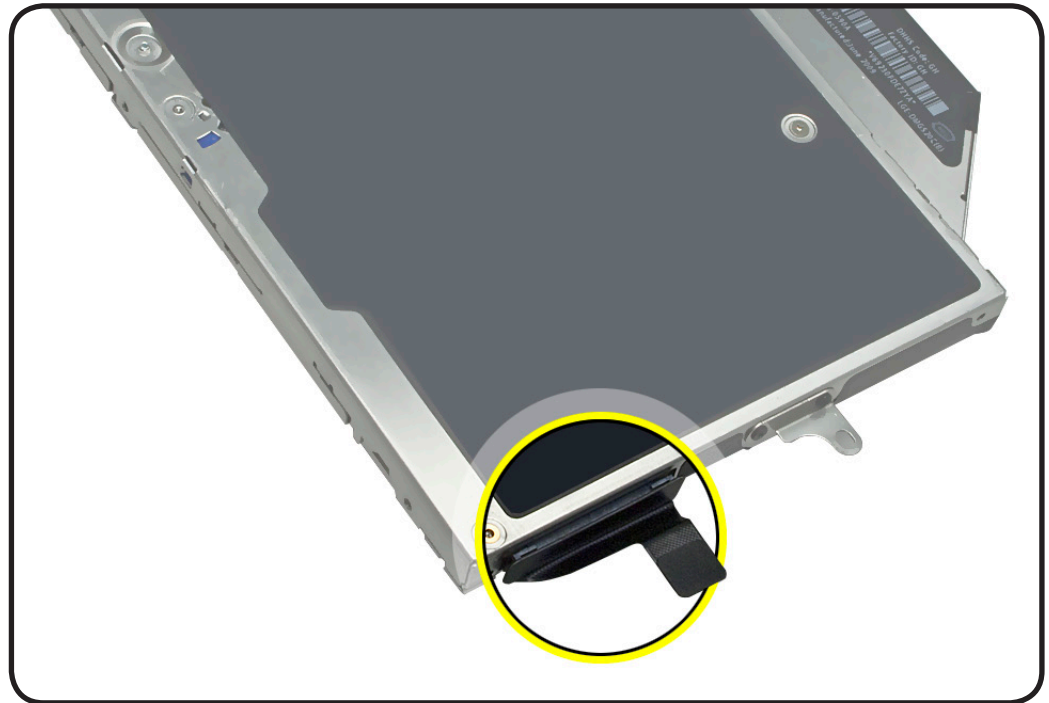

Before you begin this procedure, disconnect the battery from the logic board. Failure to do so could damage the computer.

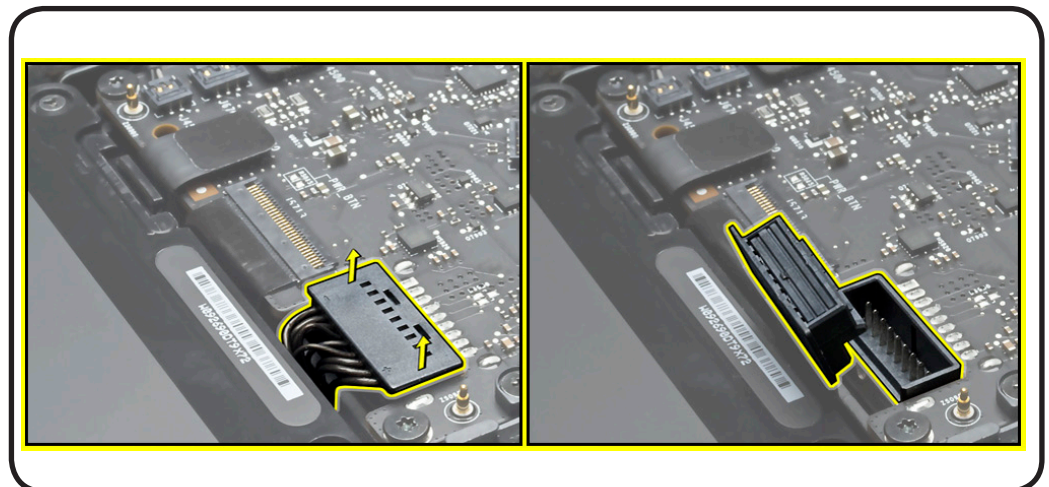



Tools

- Clean, soft, lint-free cloth
- ESD wrist strap and mat
- Black stick

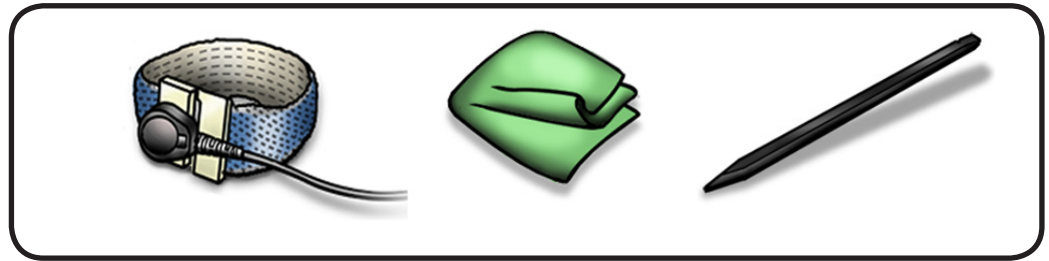

Removal

- 1 Handle optical drive by sides only.
- 2 With a black stick or fingernail, carefully wiggle flex cable off optical drive.

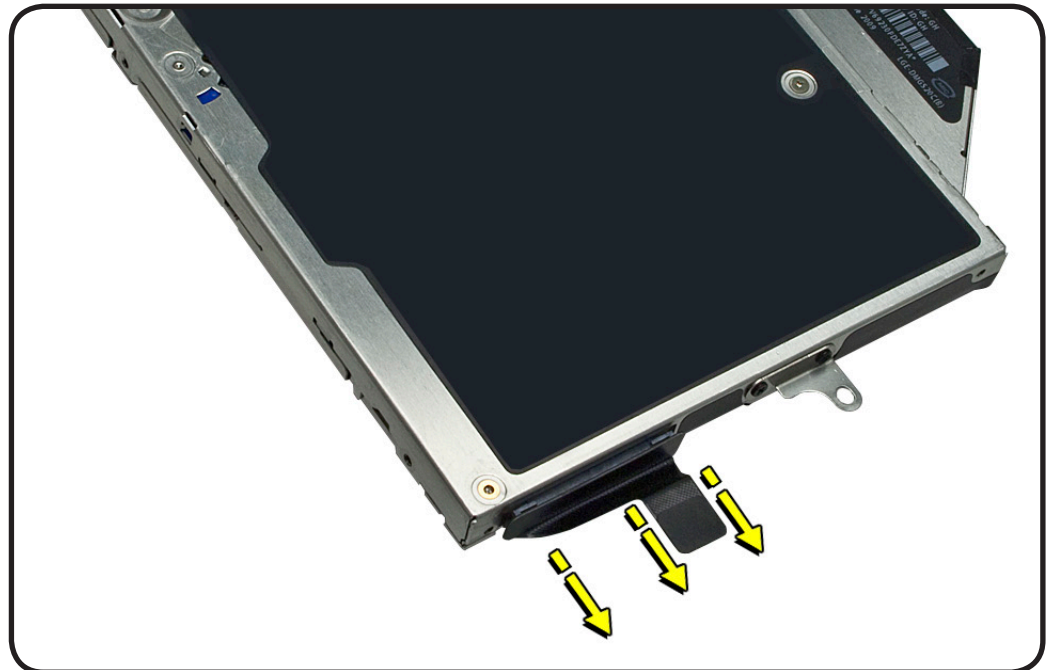



Logic Board

First Steps

Remove:

- Bottom case
- Memory
- Fan
- Rear vent

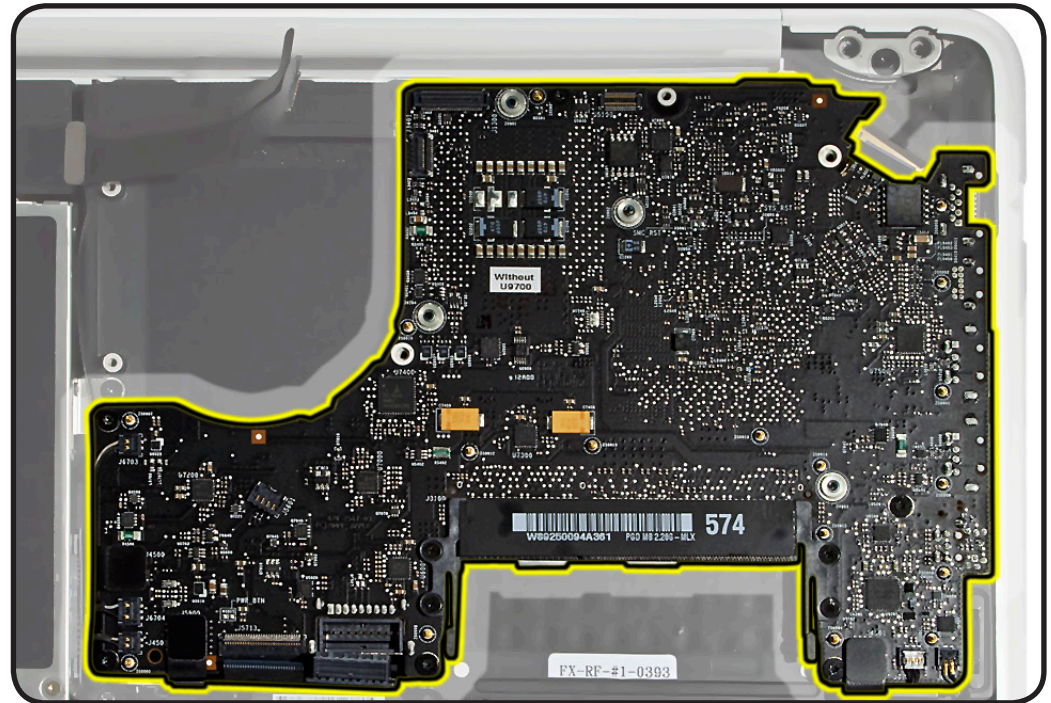

Before you begin this procedure, disconnect the battery from the logic board. Failure to do so could damage the computer.

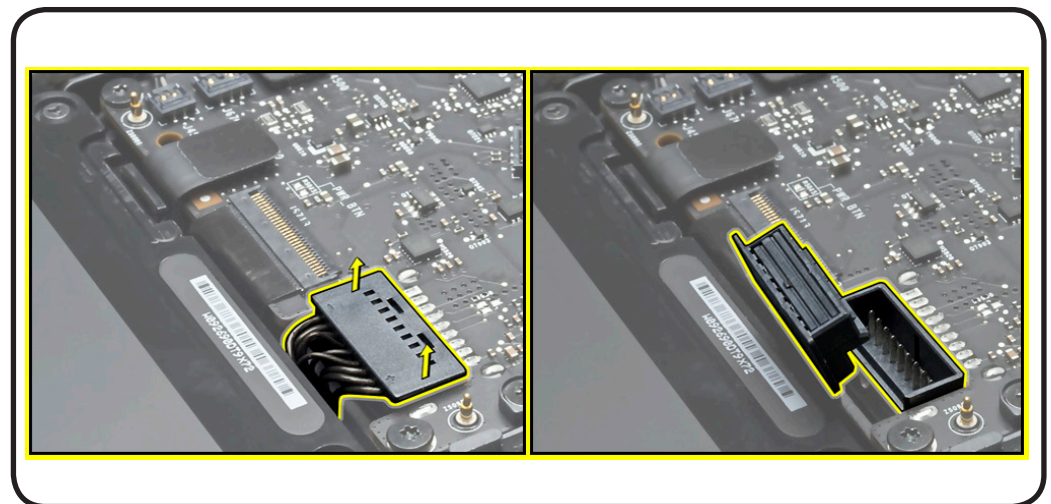



Tools

- Clean, soft, lint-free cloth
- ESD wrist strap and mat
- Torx T6 screwdriver
- Black stick
- Kapton tape



In addition, a headphone jack, such as Apple part # 661-5125, is recommended for port alignment.

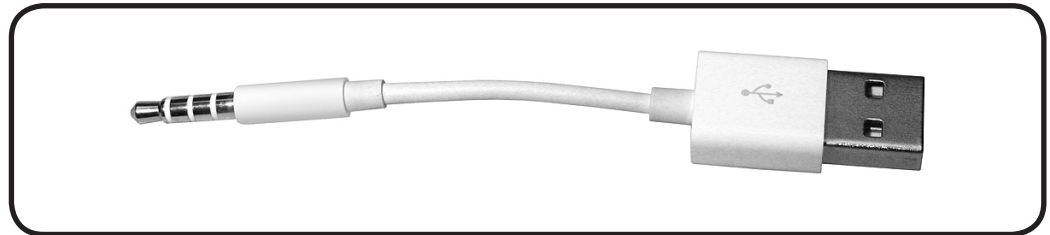

Removal

1 Caution: Refer to [Connector Types](#) to carefully disconnect 10 cables:

- 5 vertical insert (2 speaker, 1 AirPort/Bluetooth, 1 sleep LED, 1 microphone)
- 3 solid platform flex (optical drive, trackpad, hard drive)
- 1 locking lever (keyboard)
- 1 thin, multi-pin horizontal insert (LVDS)

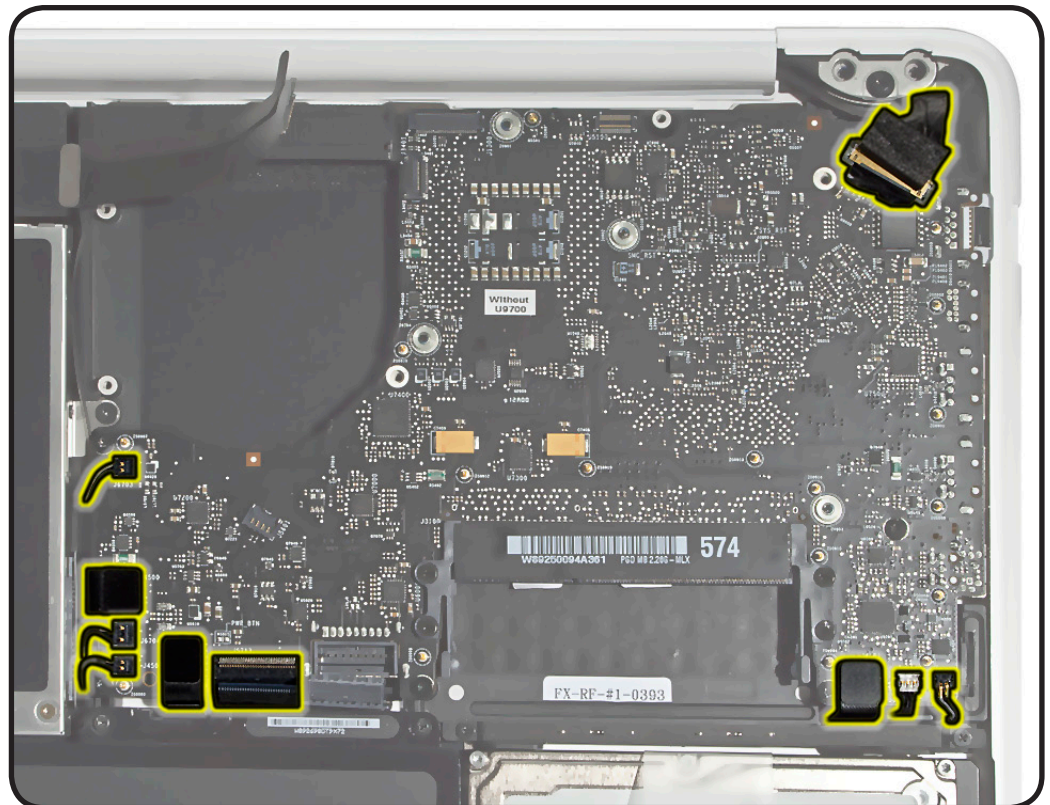



- 2 Remove 6 (4.35 mm) 922-9253 screws

Replacement Note:
Install screws in the order shown.

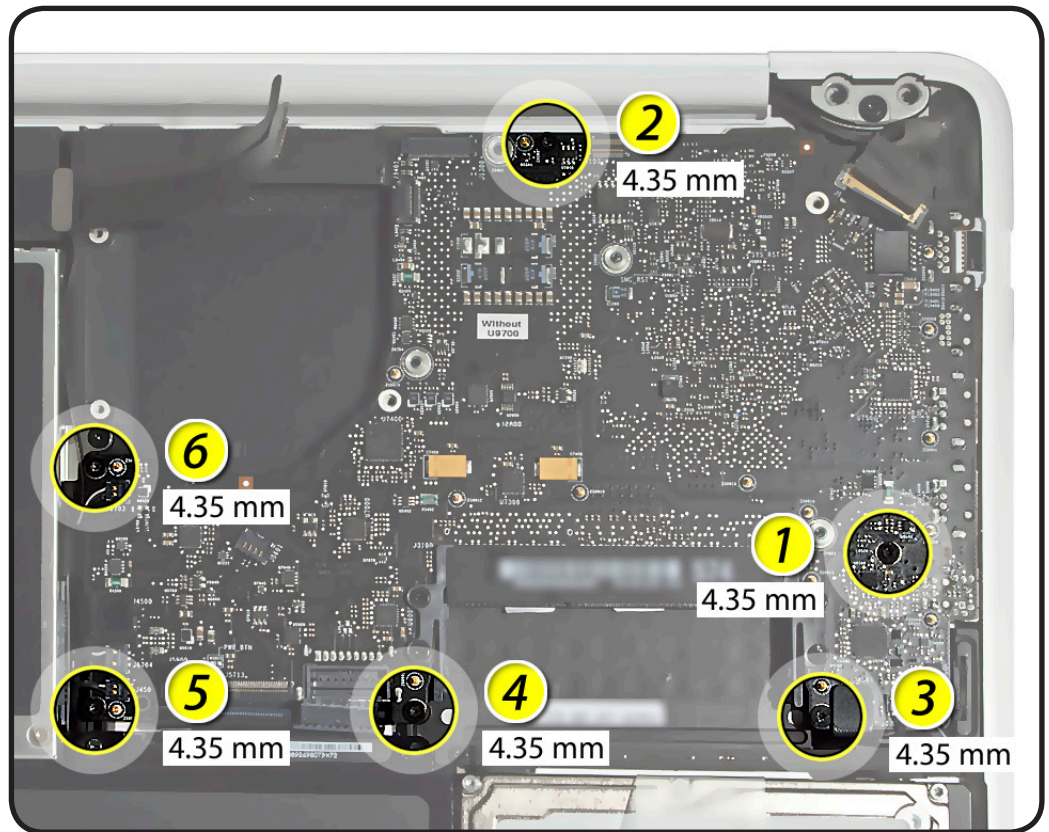

- 3 Tilt up end of logic board closest to optical drive.





- 4 Tilt board away from ports, carefully turn over board, and disconnect MagSafe connector cable underneath logic board.

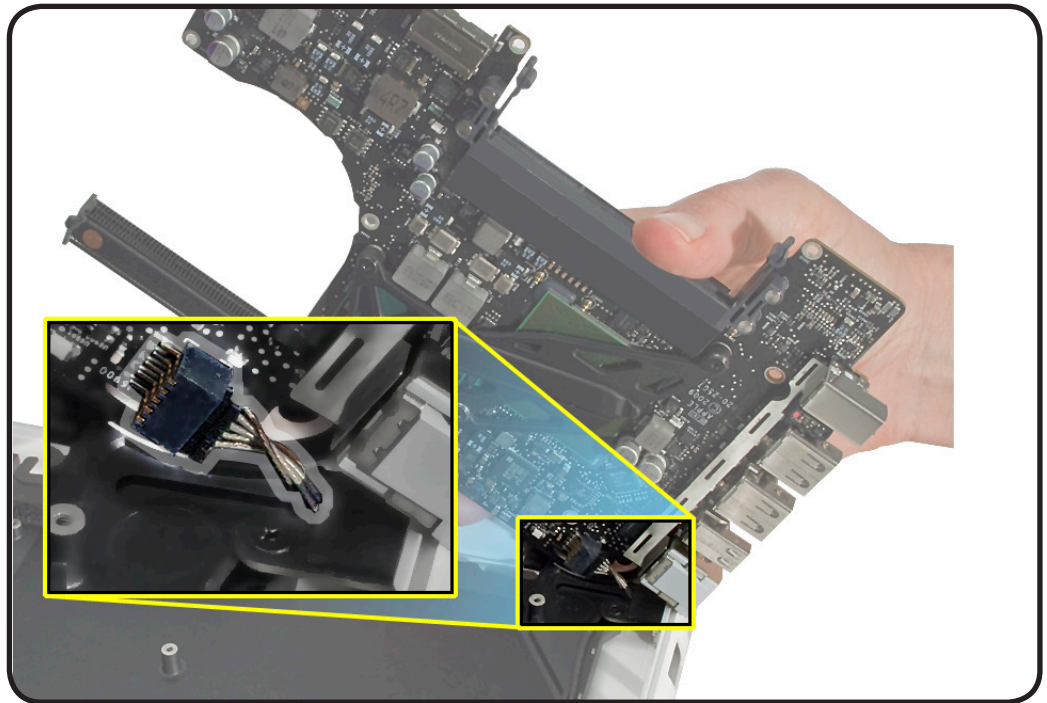

Replacement

Important: If replacing the logic board with a new one, refer to [Heatsink](#) to transfer the heatsink.

When returning a logic board, be sure to remove the heatsink.

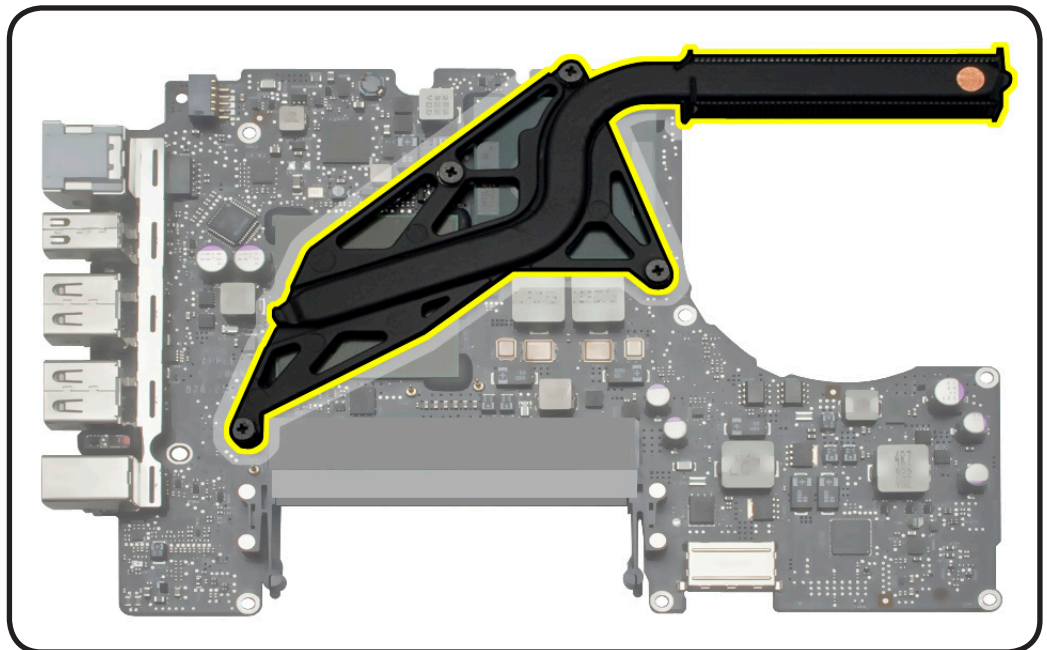



Caution: Before ordering a replacement logic board, enter the product serial number in GSX to find the compatible part.



Note: If your repair site has a bar code reader, the logic board serial number is on the left:

- A = logic board
- B = system

Or—to be sure—you can find the logic board serial number on the heatsink side of the board.

Important: Do not remove the label.

If the serial numbers are stacked:

- top = system
- bottom = logic board

1 Caution: To prevent pinched cables, make sure cables are routed in top case before replacing logic board.



Replacement Note: If replacing the logic board with a new one, transfer memory cards.

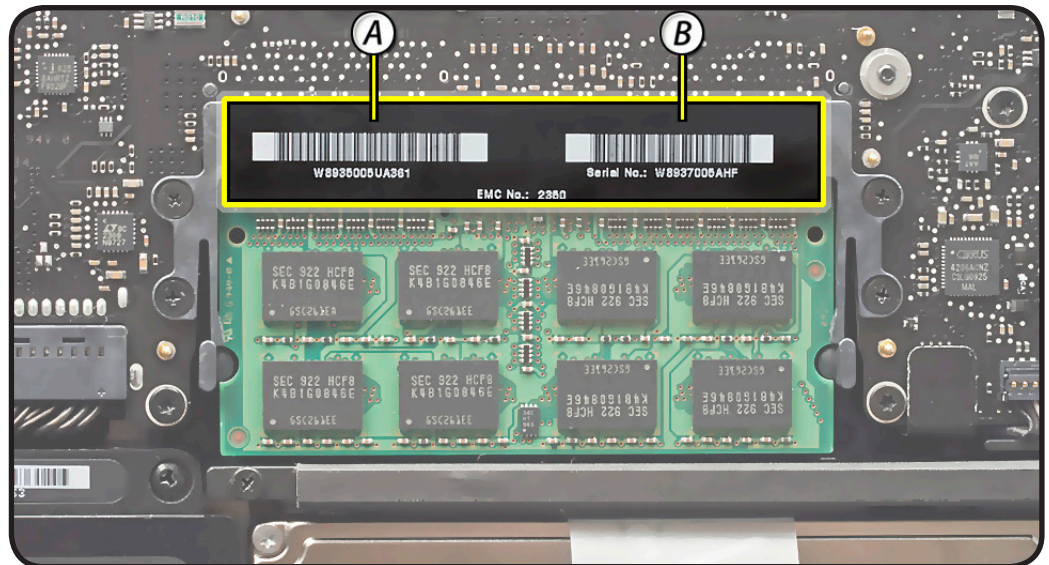



- 2 Before installing a new logic board, make sure the sleep sensor is well seated. If you need to secure it, press only where there is no chip.

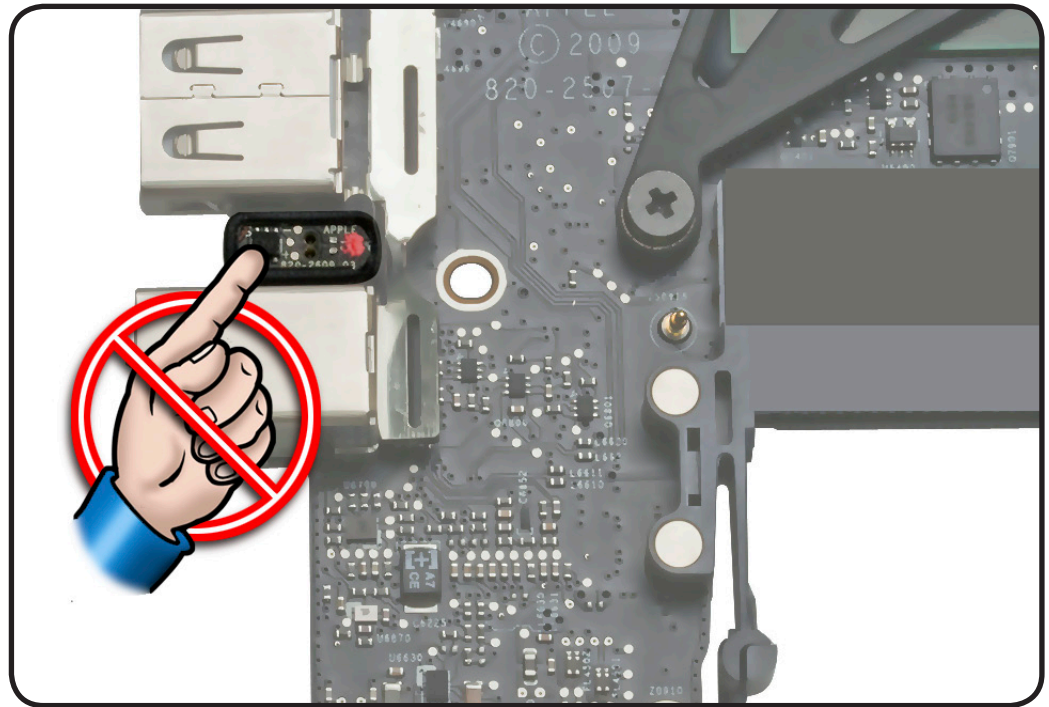

- 3 Push logic board to port side first; make sure ports align; then lower board.





- 4** Align ports and install headphone jack.



- 5** Check that screw holes align, and hold board against ports as you install screws.

- 6** Remove headphone jack.





7 Check keyboard flex cable for

- torn corners
- damaged traces
- missing traces

If keyboard cable is damaged, replace top case.

If keyboard cable looks good, go to next step.

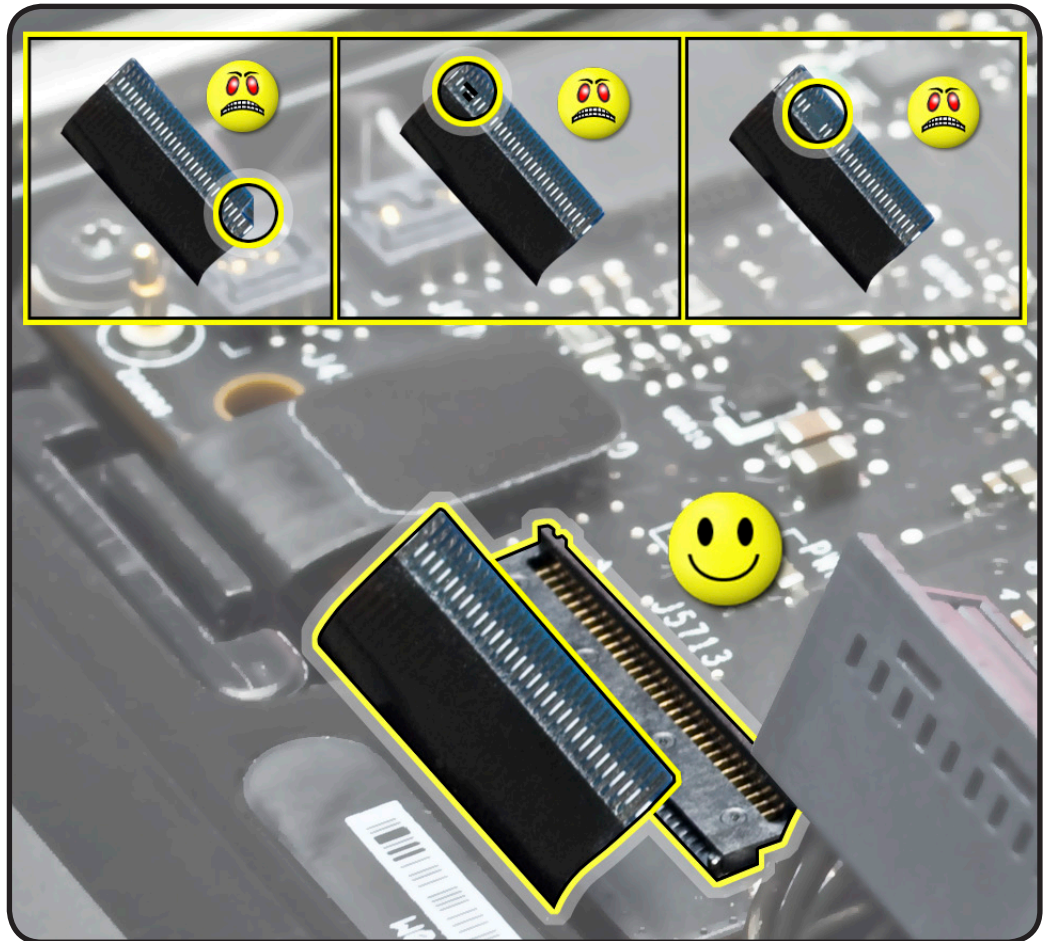

8 Use Kapton tape to install the keyboard flex cable:

- Attach tape near end of cable.
- Pull cable into locking lever.
- When cable is fully installed, close locking lever and remove tape.

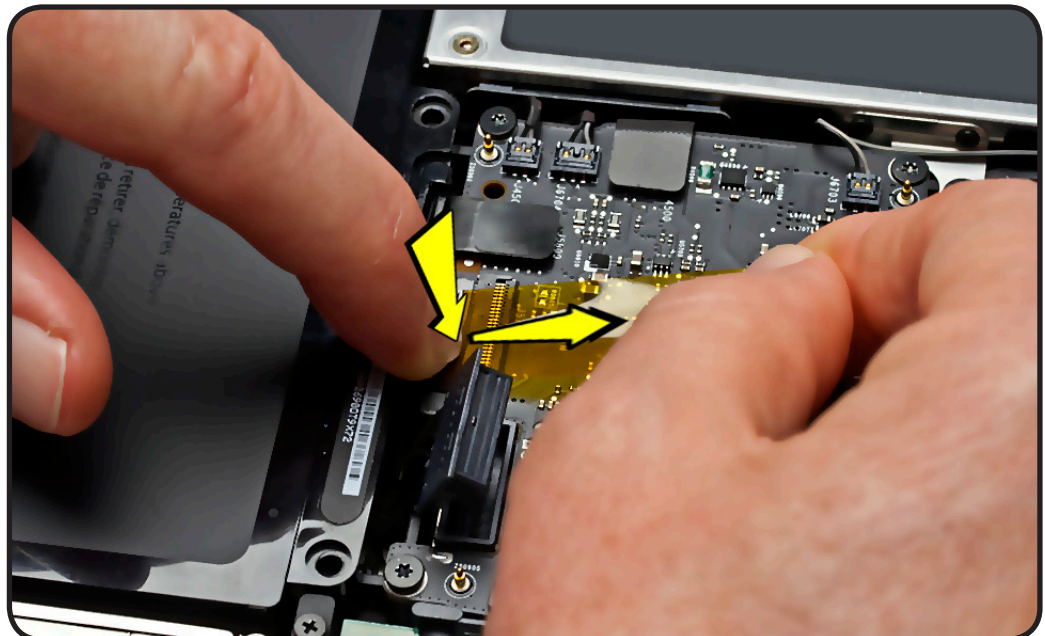



9 Replacement

Caution: To prevent video “noise,” a whining sound, no video, or a short to the logic board, be sure to place EMI gasket on LVDS connector—**positioned precisely where shown—after** cable is fully connected to logic board.

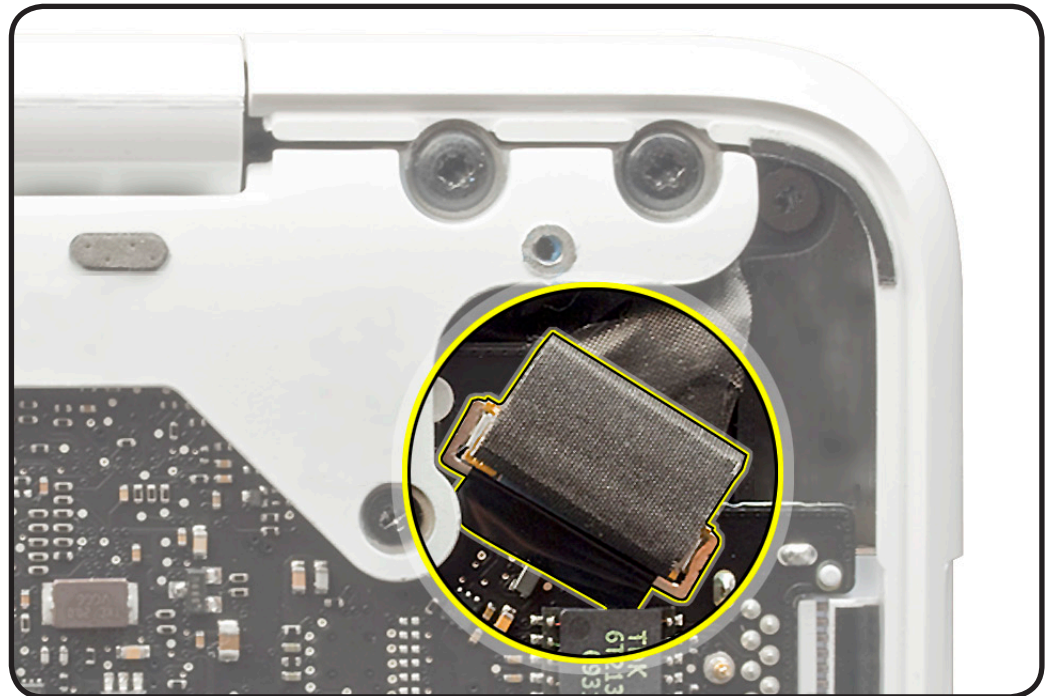

10 Reassemble and test computer.

11 Test keys shown. If they do not work, reseat keyboard cable or check for cable damage.

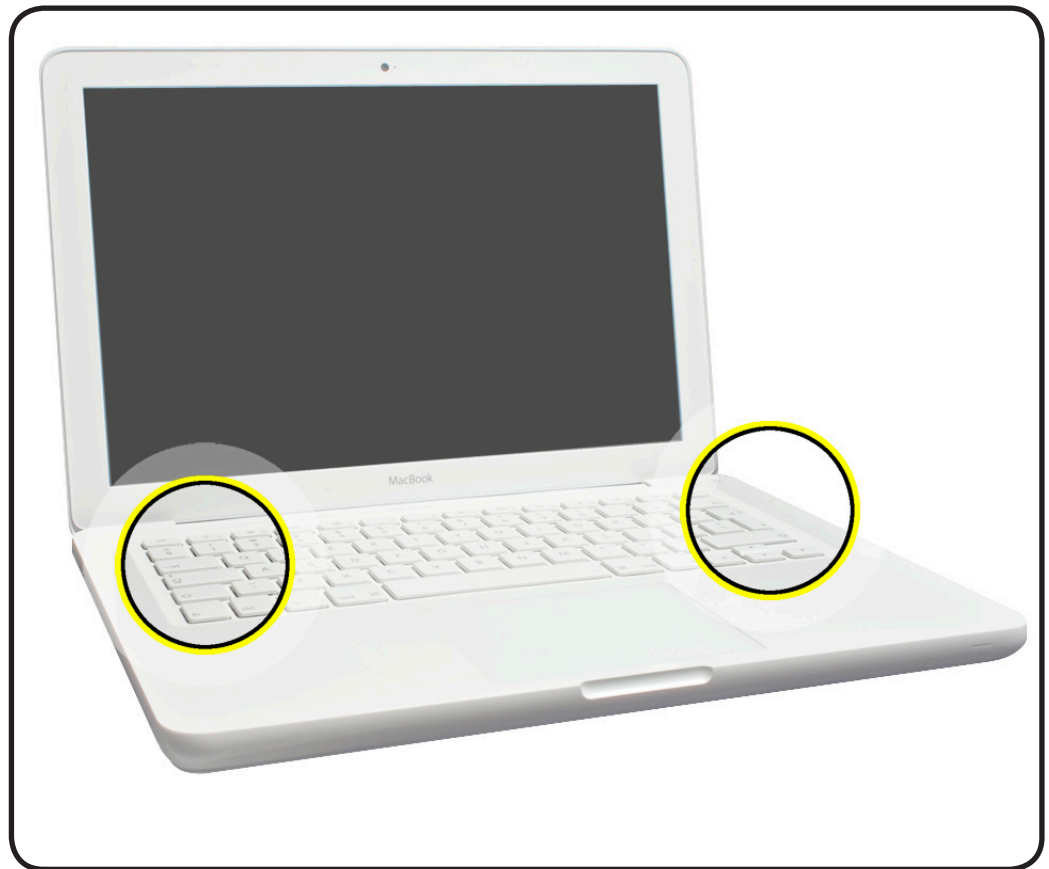



Heatsink

First Steps

Remove:

- Bottom case
- Memory
- Fan
- Rear vent
- Logic board

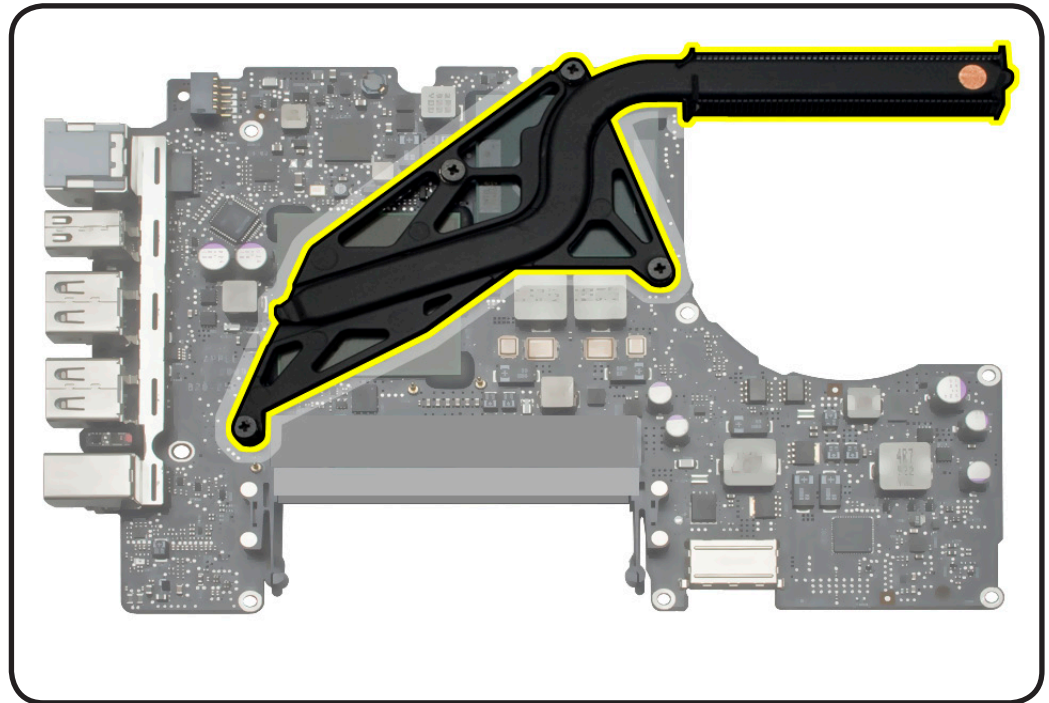

Before you begin this procedure, disconnect the battery from the logic board. Failure to do so could damage the computer.

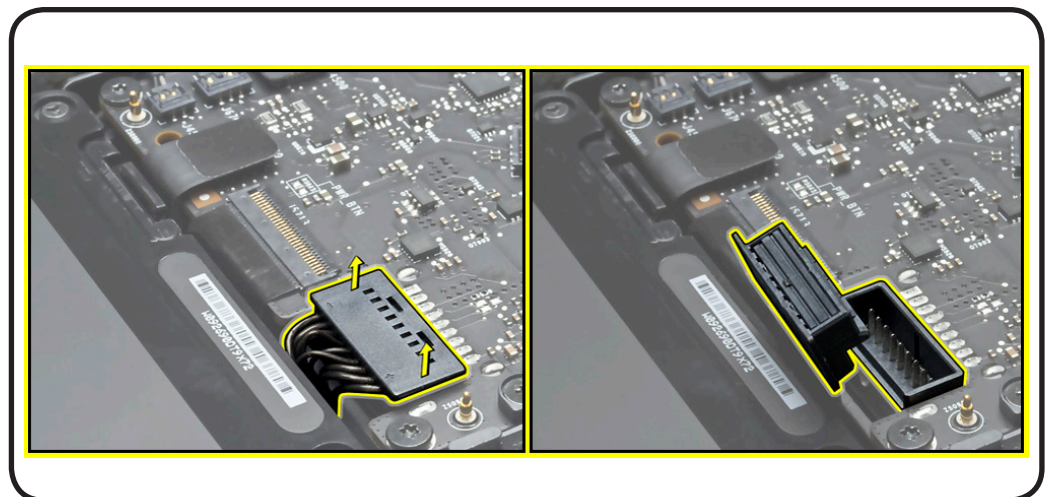



Tools

- Clean, soft, lint-free cloth
- ESD wrist strap and mat
- Magnetized Phillips #00 or #1 screwdriver
- Thermal grease syringe
- Alcohol pads
- Black stick

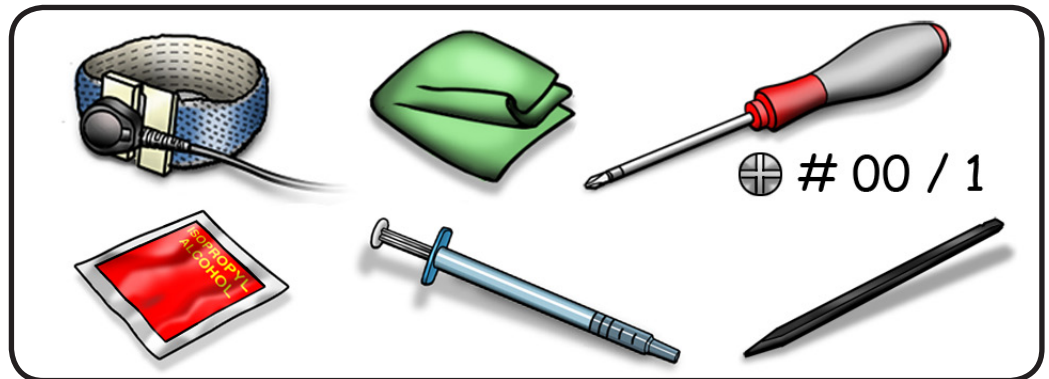

Removal

Caution: Hold heatsink by edges, not by the heat pipe.

- 1 Remove 4 (8.3 mm) 922-9207 screws and springs.

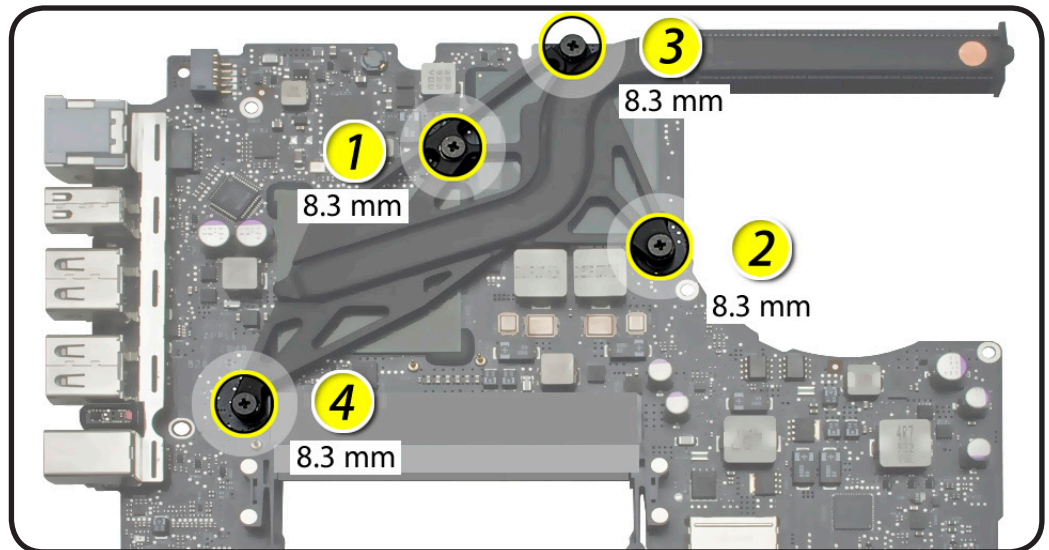

- 2 Keeping heatsink parallel to logic board, gently wiggle heatsink to loosen bond to board.

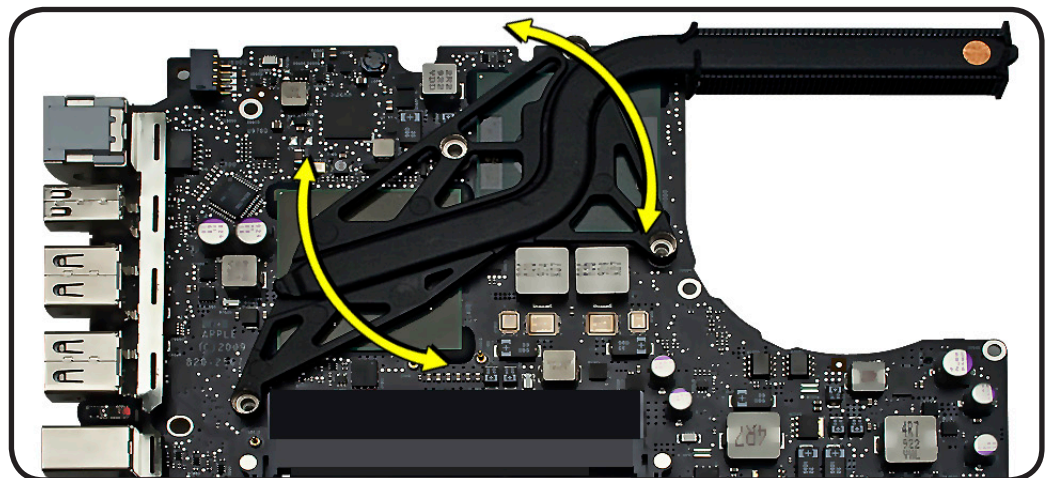



- 3** With a black stick, scrape off thermal grease and use alcohol pad to clean thermal pads

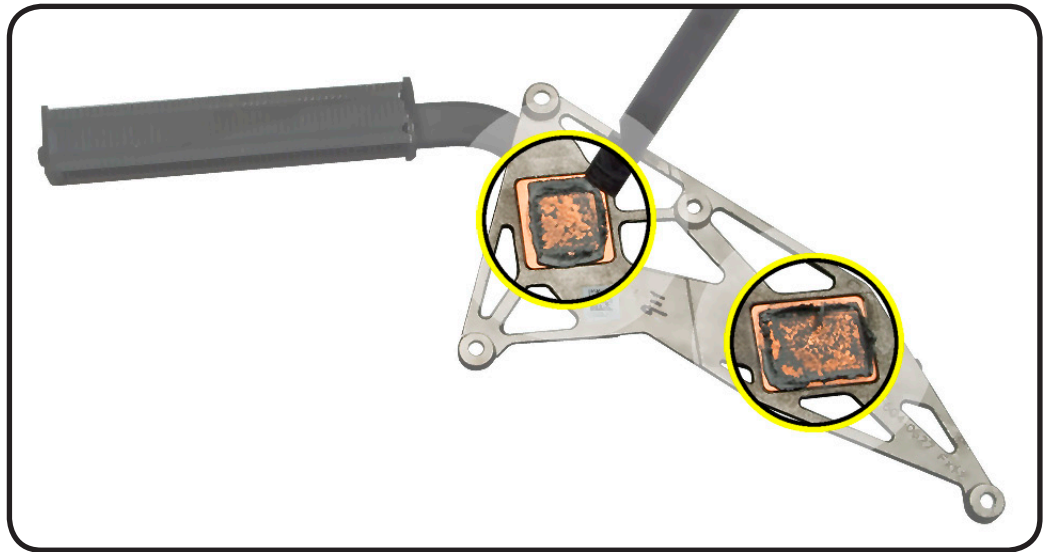

- 4** Repeat step 3 for chips on logic board.

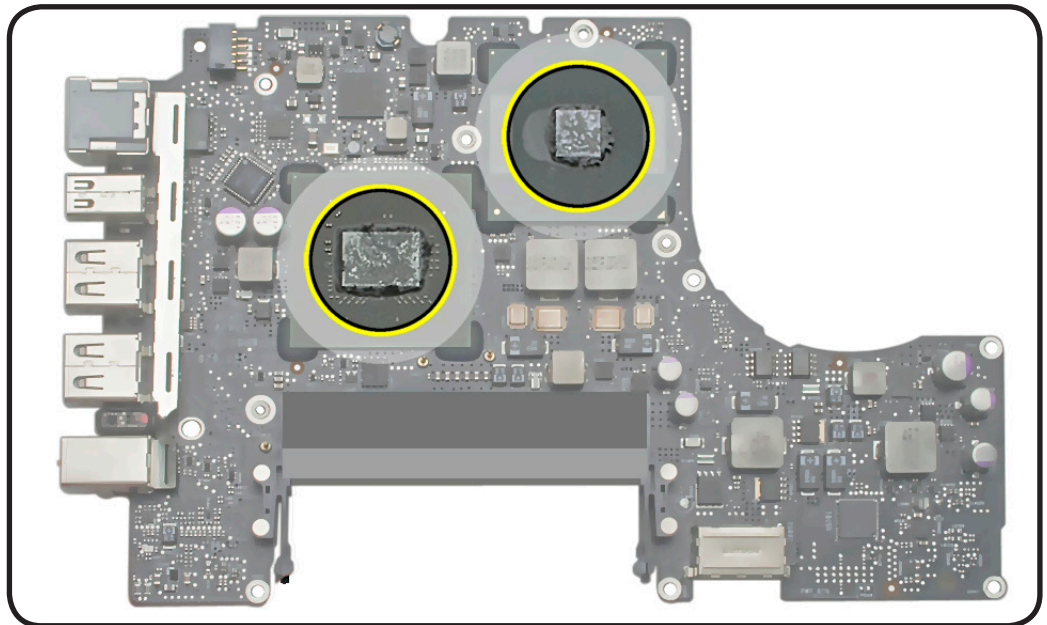



Replacement

Important: New heatsinks do not include pre-applied thermal grease.

- 1 Caution:** The syringe contains enough thermal grease for 2 to 3 chips.
Use a pen to mark the syringe in thirds.



- 2** Inject 1/3 to 1/2 of syringe contents on center of each chip.

- 3** Place heatsink over the logic board.

- 4** Install heatsink screws in order, 1/2 way first, then secure the rest of the way.

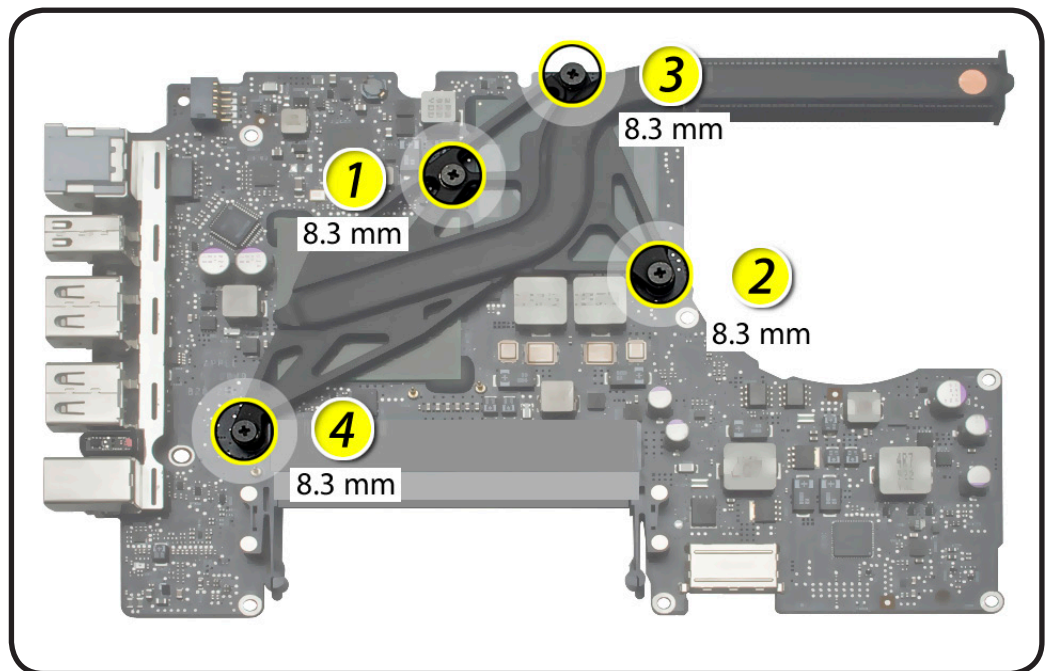



MagSafe Board

First Steps

Remove:

- Bottom case
- Memory
- Fan
- Rear vent
- Logic board

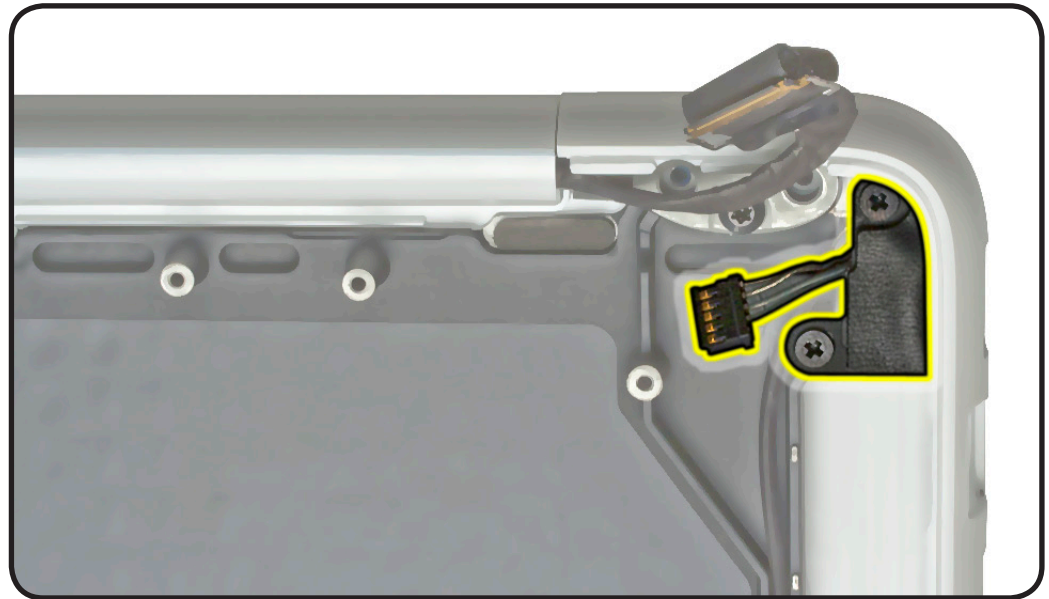

Before you begin this procedure, disconnect the battery from the logic board. Failure to do so could damage the computer.

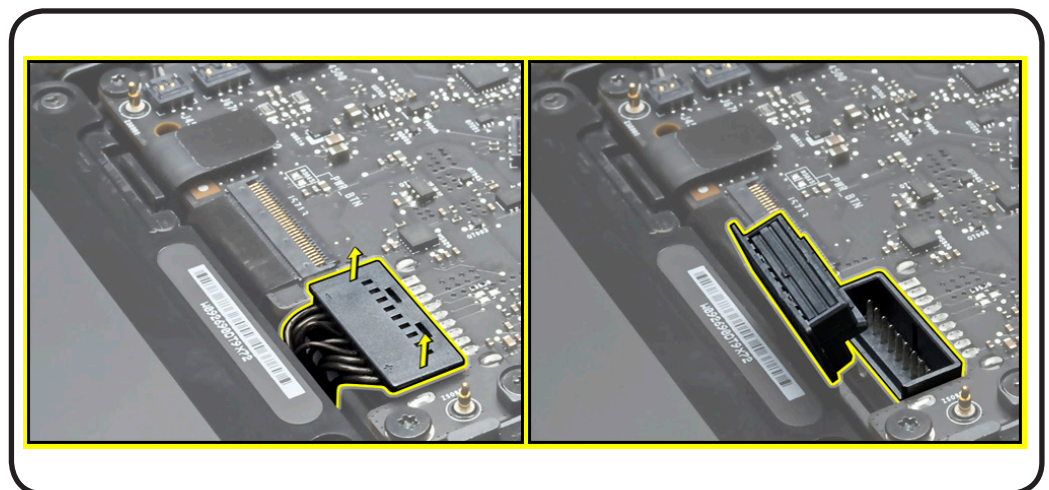



Tools

- Clean, soft, lint-free cloth
- ESD wrist strap and mat
- Torx T6 screwdriver
- Black stick

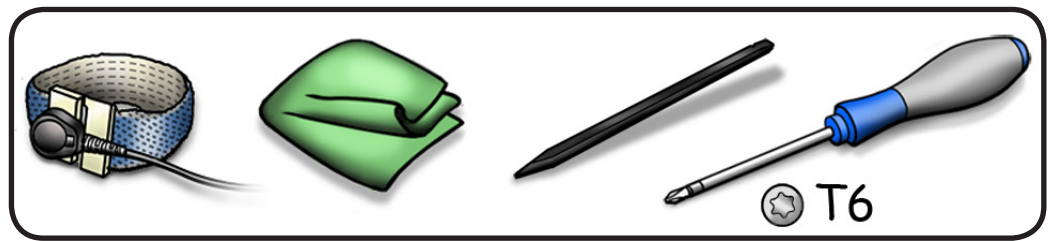

Removal

Caution: Do not press on MagSafe board.

- 1** Remove 2 (4.46-mm) 922-9250 screws.
- 2** Tilt board away from port

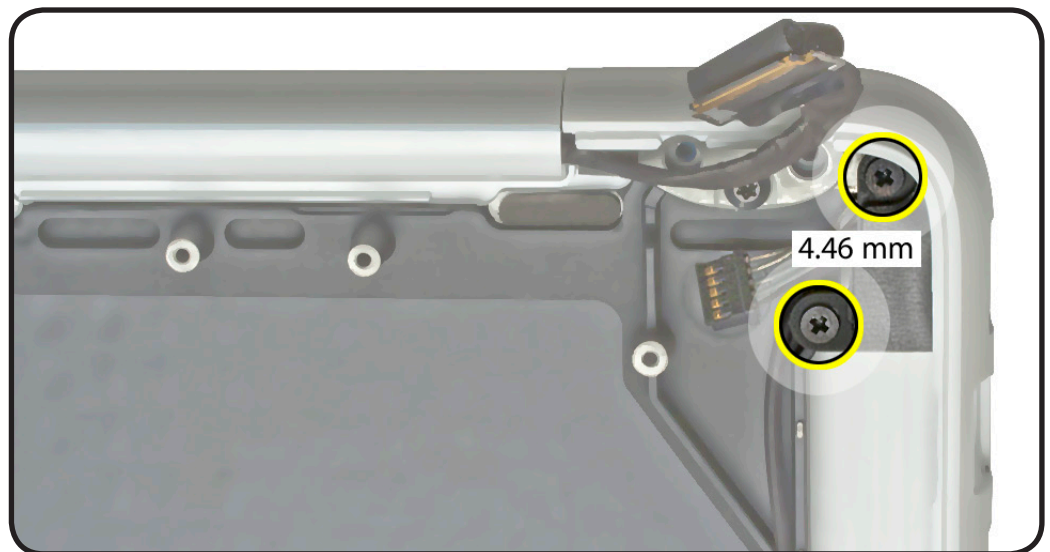



Replacement

Caution: Plug in a disconnected adapter cable.



- 1 Making sure power is off, install screws.
- 2 Test port alignment by plugging in power cable from 4 angles.
 - If port is off center and cable does not seat securely, loosen MagSafe screws, realign port with cable in place, and secure screws.
 - If port seats correctly, continue.
- 3 Connect MagSafe cable to logic board.
- 4 Install logic board and remaining parts.
- 5 With computer fully assembled, test power with power cable.

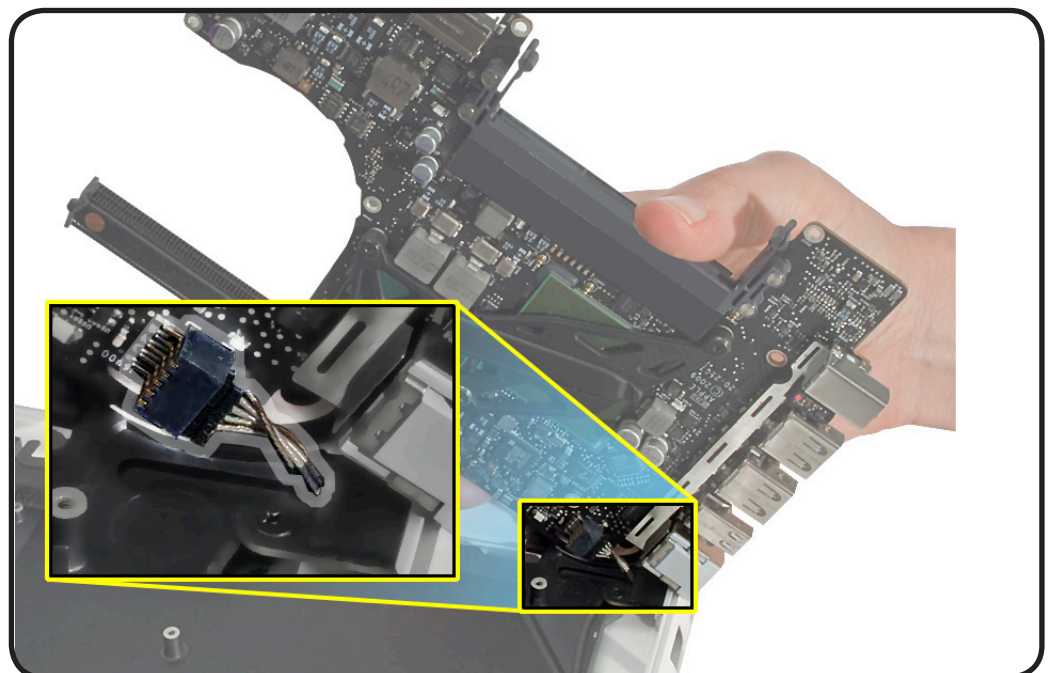
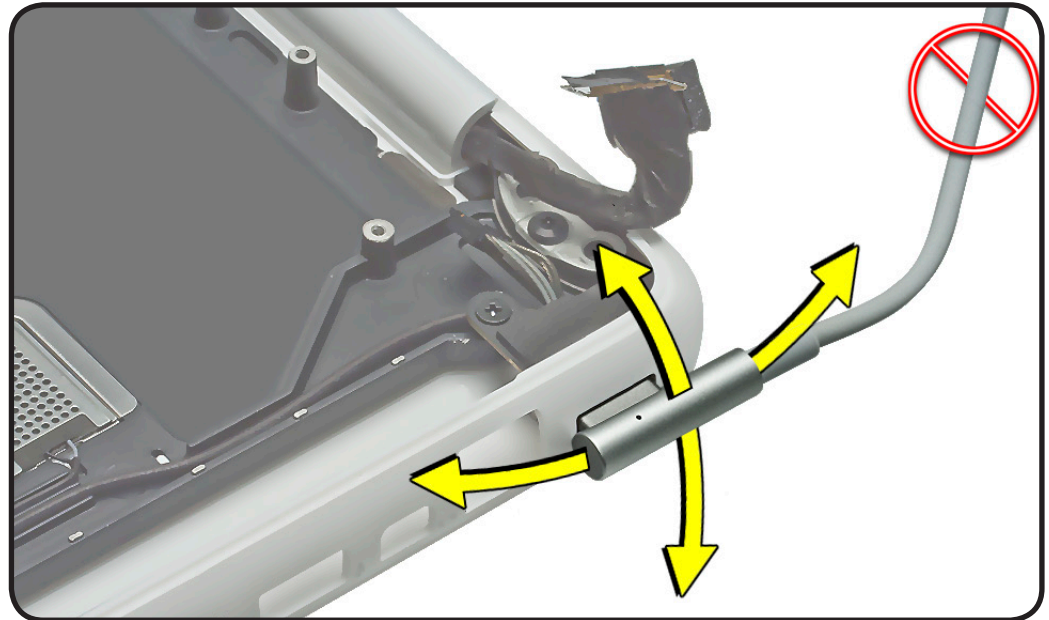



Display Module

First Steps

Remove:

- Bottom case
- Rear vent



Before you begin this procedure, disconnect the battery from the logic board. Failure to do so could damage the computer.

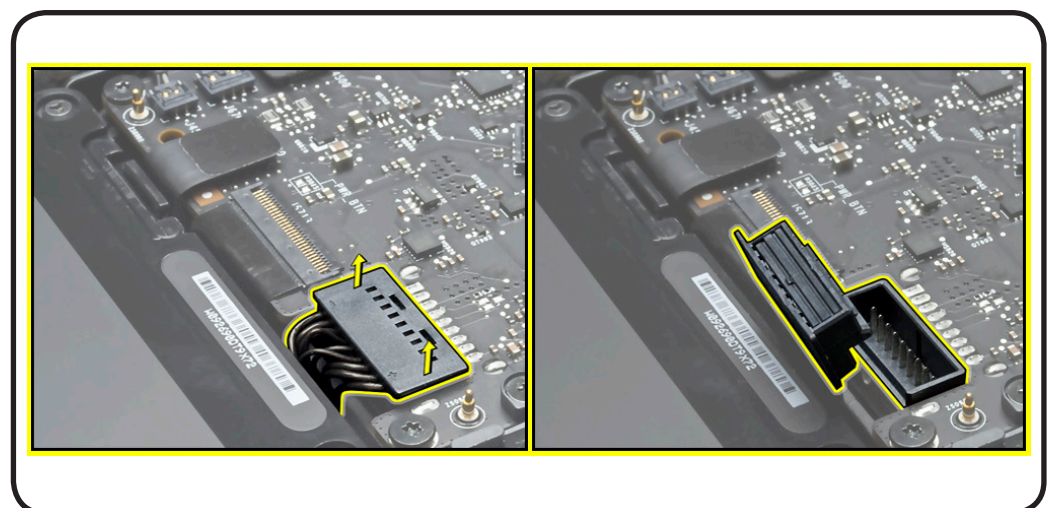



Tools

- Clean, soft, lint-free cloth
- ESD wrist strap and mat
- Magnetized Phillips #00 screwdriver
- Torx T8 screwdriver
- Needle-nose pliers
- Black stick
- Foam wedge fixture (or table edge)
- Torque driver, optional

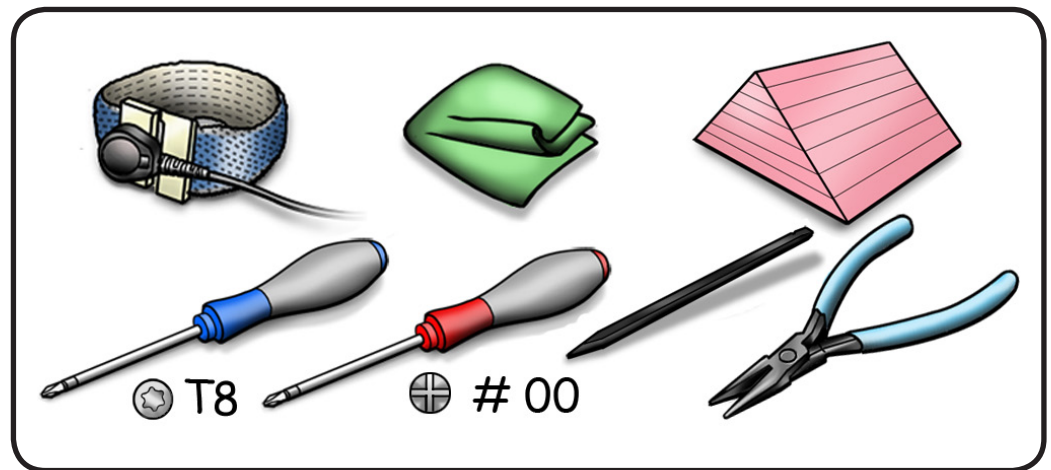

Removal

- 1 Start with display open on foam wedge fixture.

Note: If fixture unavailable, place display (open to 90 degrees) so it safely hangs over a clean, padded table edge. The back of the display housing should face you. Use a clean, soft, lint-free cloth to protect the top case and housing from scratches.

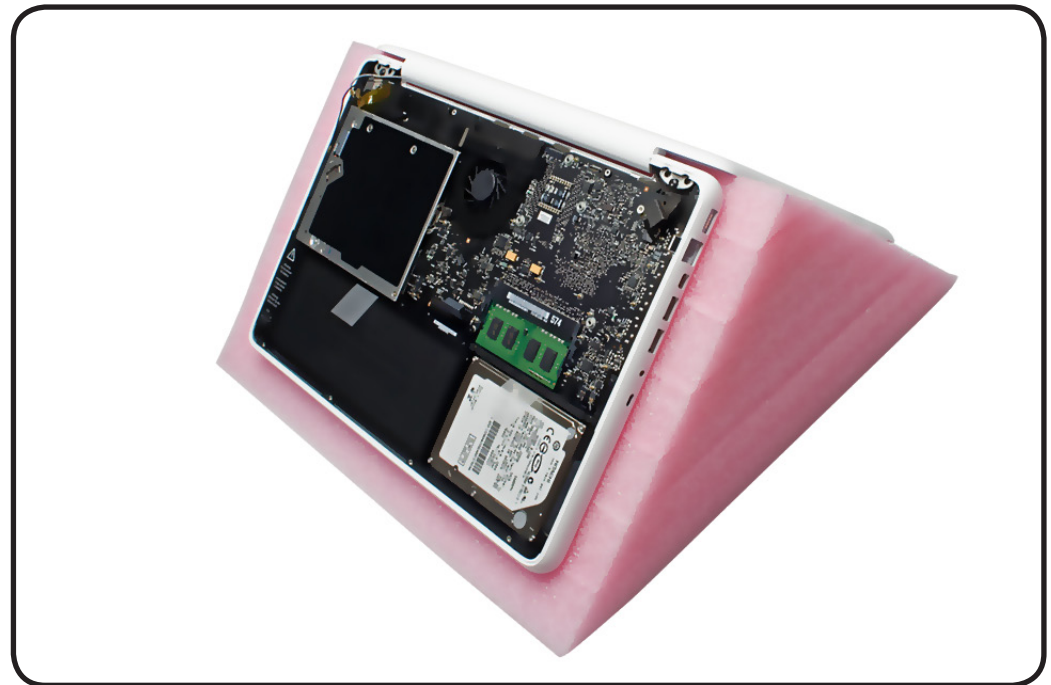



2 Use needlenose pliers to disconnect 3 cables.

3 Remove 2.98 mm (922-9200) ground screw at tab.

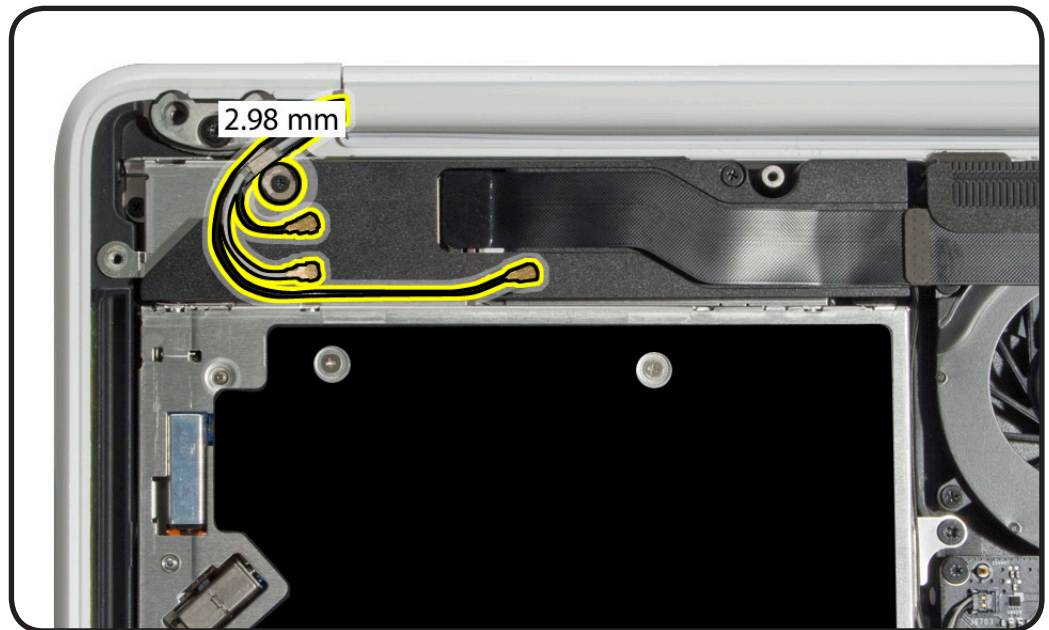

4 At LVDS cable remove gasket, peel up black tape over locking bar, and disconnect LVDS cable (image shows cable already disconnected). Pull the cable, not the locking bar.

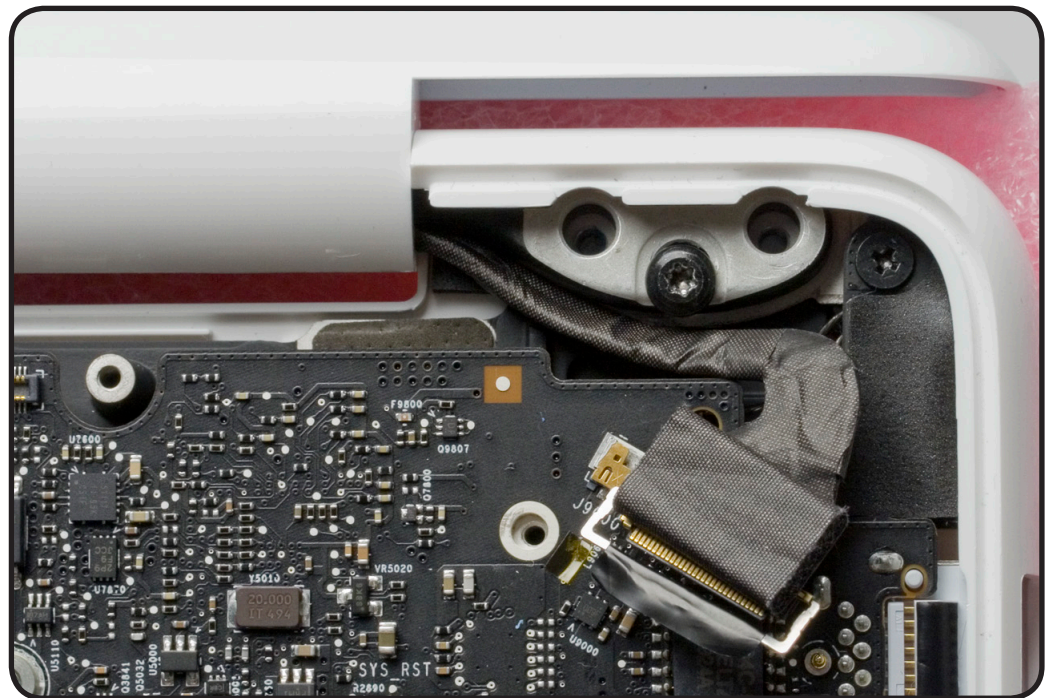



Replacement Caution: To prevent video “noise,” a whining sound, no video, or a short to the logic board, be sure to place EMI gasket on connector—**positioned precisely where shown**—**after** cable is fully connected to logic board.

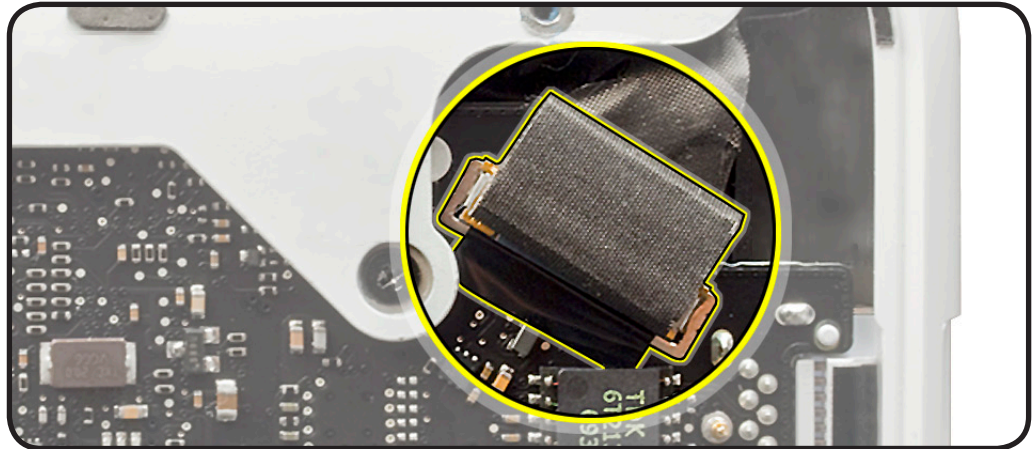

- 5 Remove 2 (7.79 mm) 922-9263 screws from display hinges.

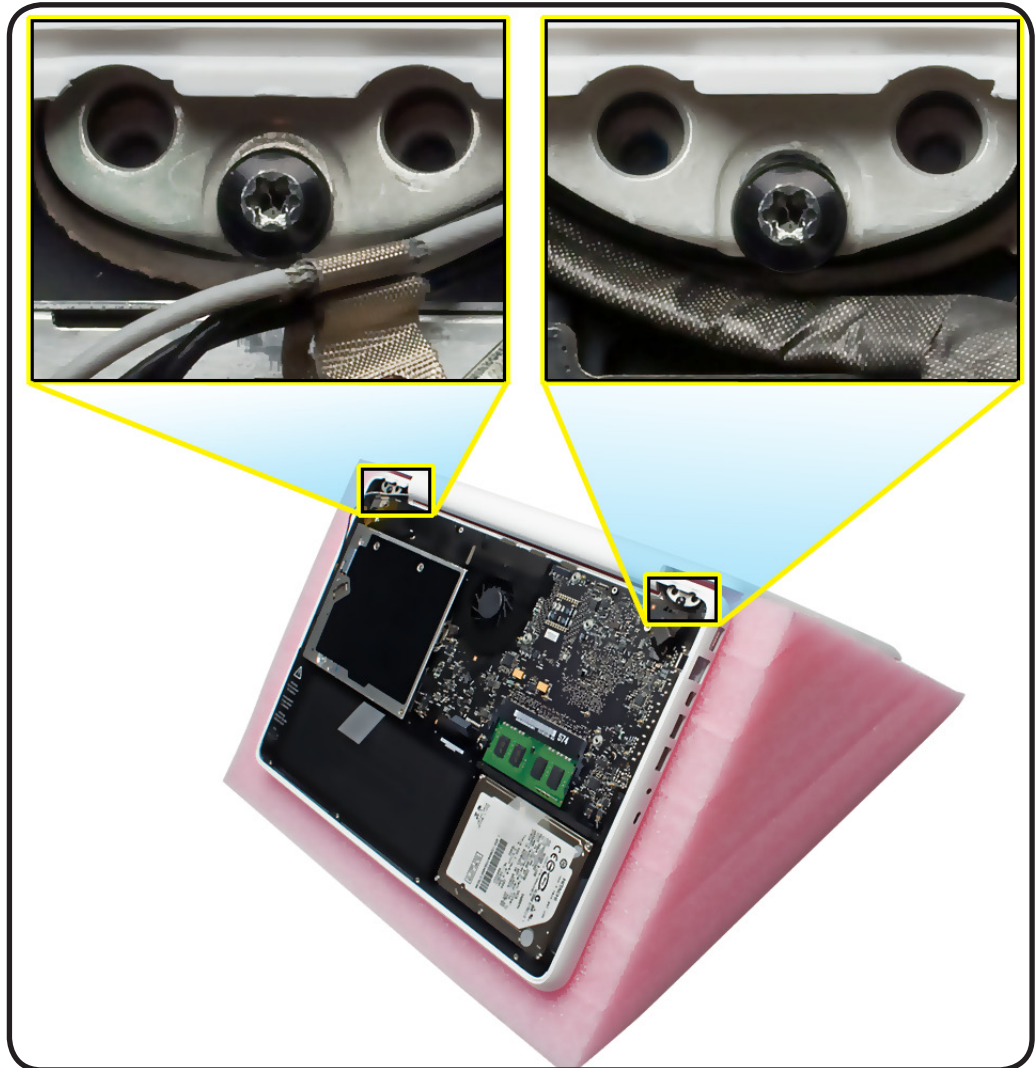



- 6 Holding display at sides, separate display from top case.

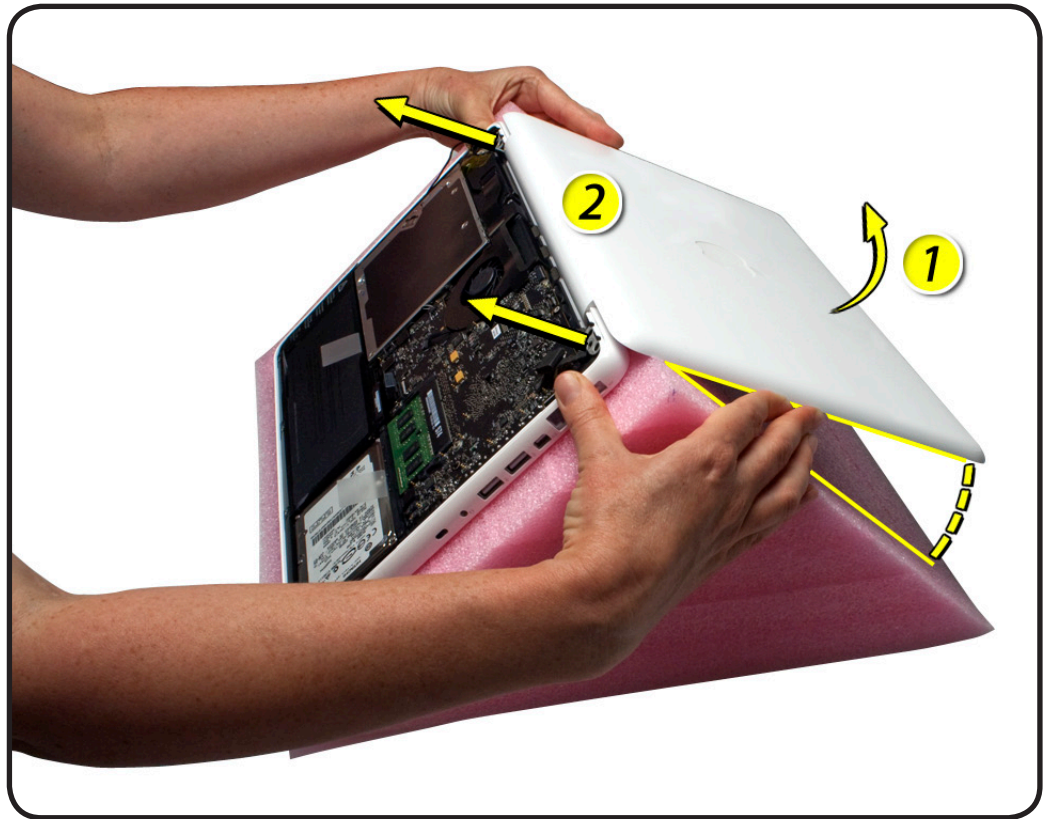



Replacement

- 1 With display on foam wedge service fixture, align screw holes and install center screws.

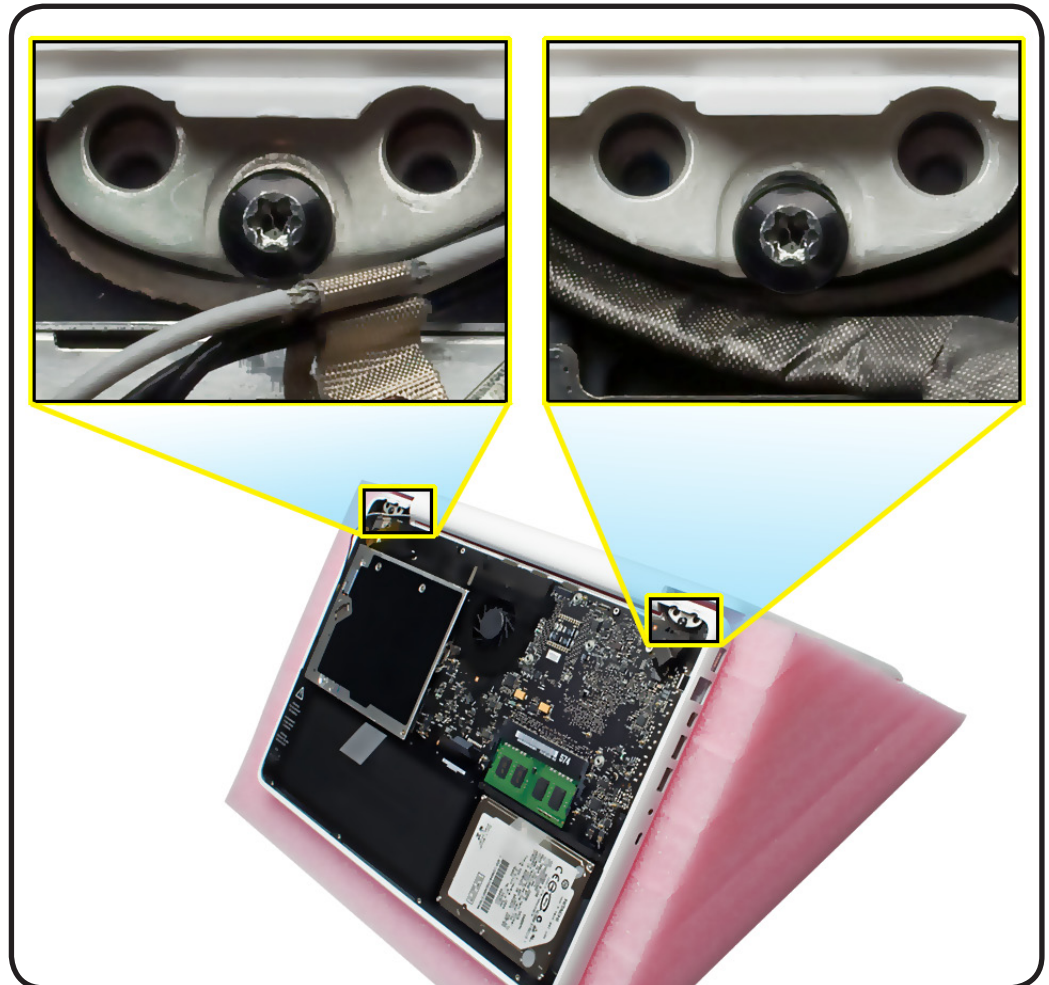

- 2 Close display and place the system on a flat surface.

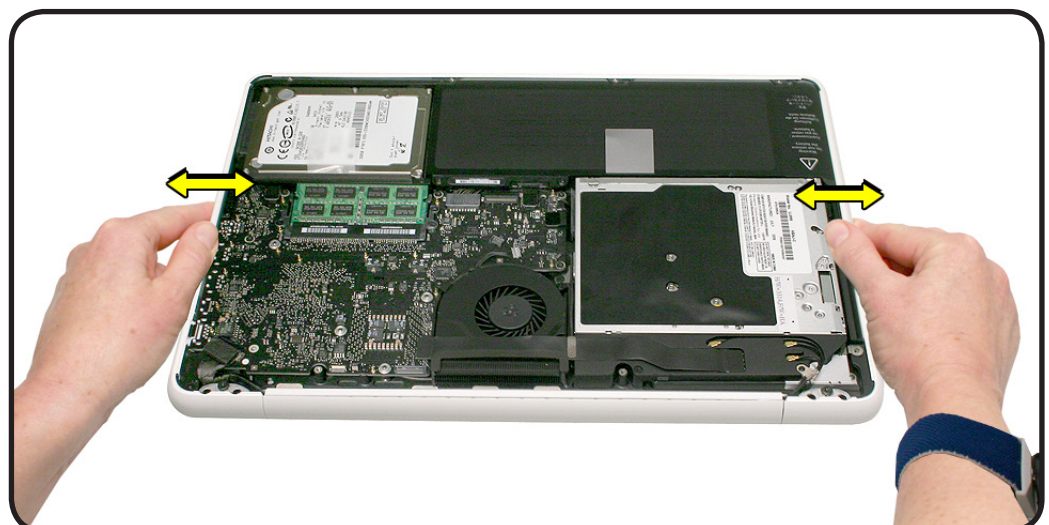

- 3 Loosen the 2 center screws and adjust the alignment by touch.



- 4 Stand up the computer on a clean, flat surface to level the rear clutch alignment.

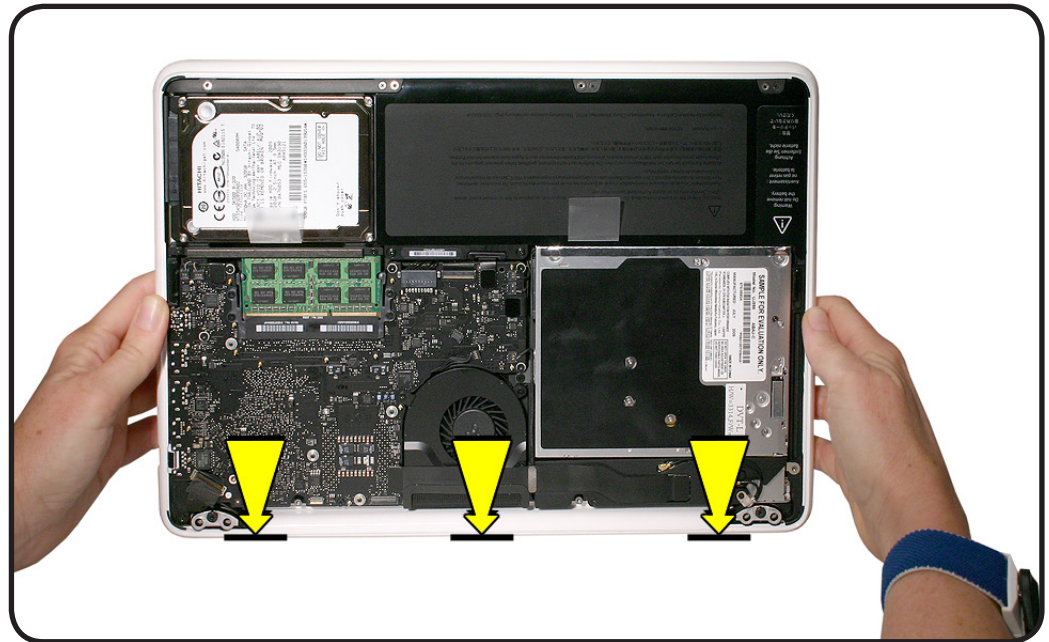

- 5 Use a business card to verify uniform alignment at clutch.

- 6 Secure 2 center screws.

Note: Use a torque driver, if available, to tighten to 5.6 ± 0.17 inch pounds (6.5 ± 0.2 Kgf-cm).

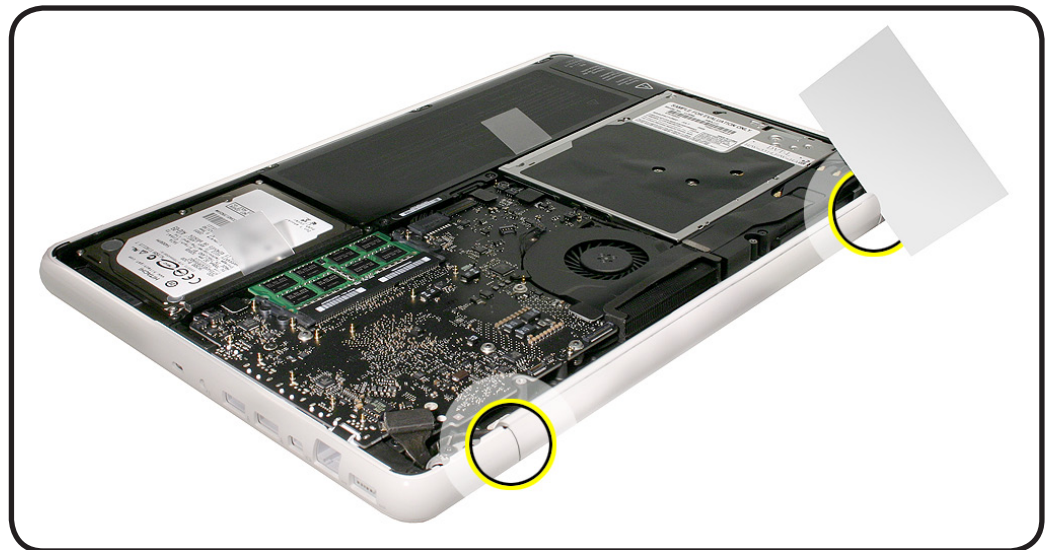



7 Check for uniform alignment all along edges at:

- clutch
- sides
- front

8 If overlap or gaps, loosen center screws, adjust fit, secure screws, and verify alignment again.

9 With proper alignment verified, secure rear vent screws while computer is closed, and complete computer assembly.

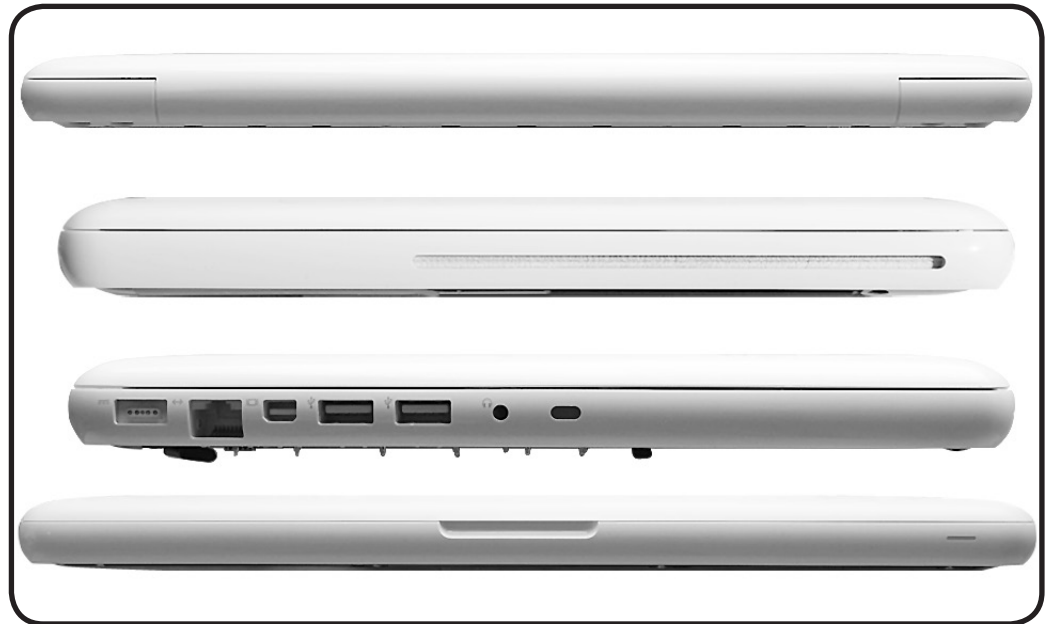



Top Case with Keyboard

First Steps

Remove:

- Bottom case
- Memory
- Hard drive bracket
- Hard drive
- Fan
- Rear vent
- AirPort/Bluetooth flex cable
- Display module
- Logic board
- MagSafe DC-in board
- Rear speaker
- Optical drive
- Battery
- Trackpad

With the first steps completed, the top case is the remaining part.

The top case includes:

- keyboard
- left/right embedded speakers and cables
- microphone cable
- sleep LED
- front hard drive bracket and grommets
- trackpad flexures

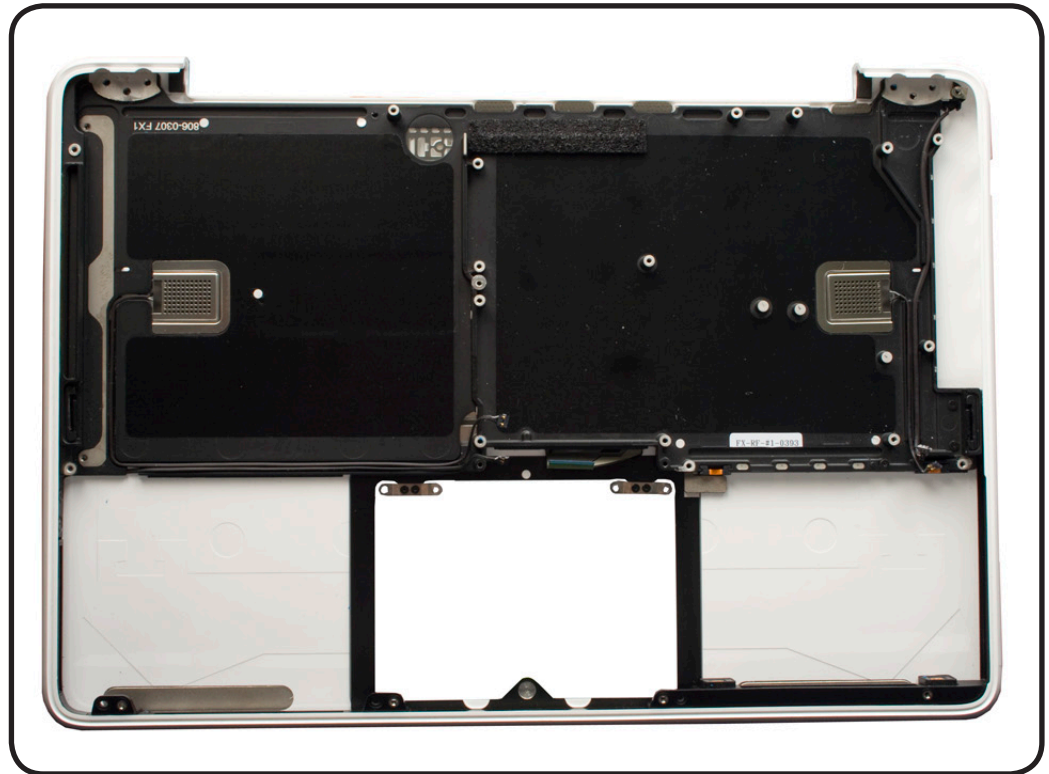



Replacement Note: A new top case includes 2 trackpad flexures pre-installed with 4 screws. When transferring a trackpad into the new top case, do not remove the flexures and 4 inner screws.

Caution: Before ordering a replacement top case, enter the product serial number in GSX to find the compatible part.

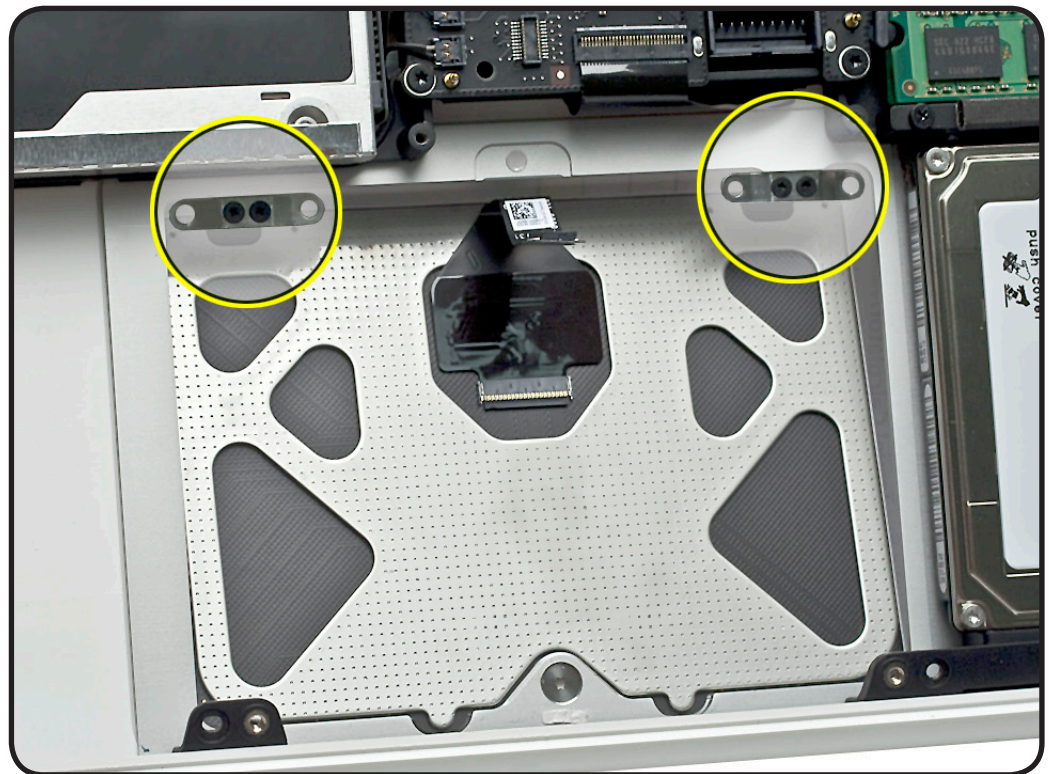

Additional Procedures

MacBook (13-inch, Late 2009)



Trackpad Grounding Strap

Overview

User-induced electrostatic discharge (ESD) can cause the trackpad to exhibit jumpy cursor movement. Installing a conductive grounding strap from trackpad to system chassis ground resolves this issue. Follow this procedure to correct for jumpy cursor movement.

First Steps

Order Trackpad Grounding Strap Kit

Apple part # 922-9340 includes 20 straps, but only one is needed per computer repair.

Remove:

- Bottom case
- Battery

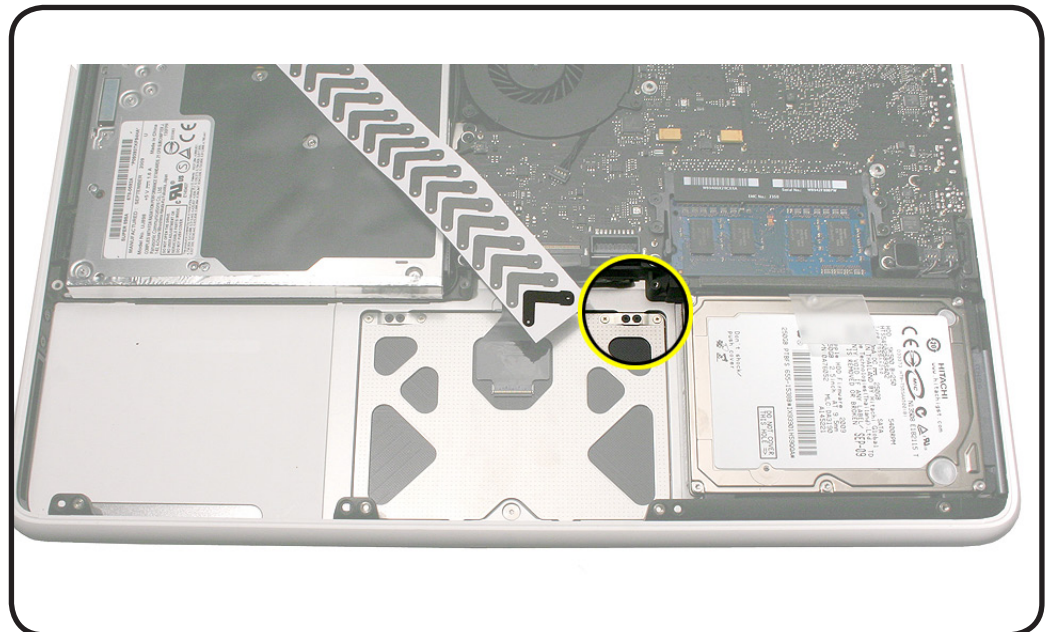

Tools

- Clean, soft, lint-free cloth
- ESD wrist strap and mat
- Black stick
- Magnetized Phillips #00 screwdriver
- Large tri-lobe #0 screwdriver

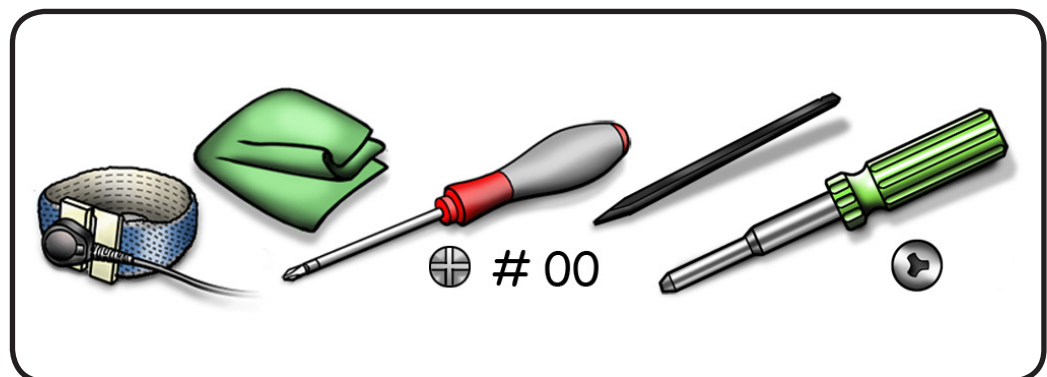



Procedure

1 Locate 2 end points in battery bay.

2 Remove 1 trackpad screw.

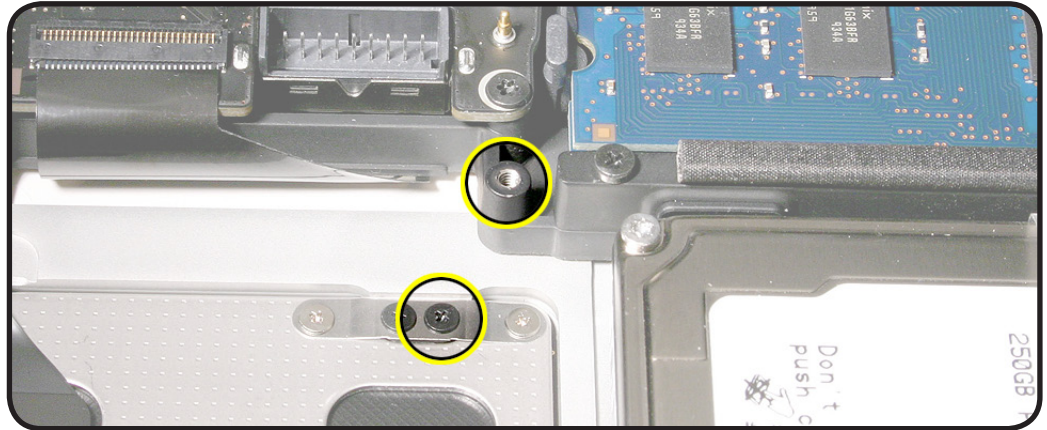

3 Use 1 tri-lobe battery screw, installed part way, to anchor square end of 1 grounding strap.

4 Adhere grounding strap onto top case and align screw holes.

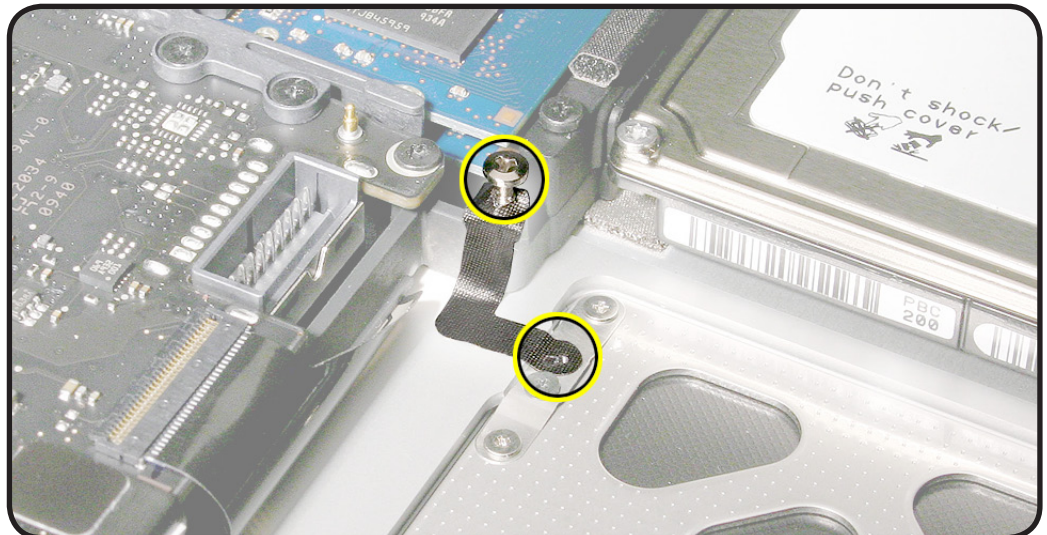

5 Remove tri-lobe battery screw and install trackpad screw.

6 Install battery and reassemble computer.



Views

MacBook (13-inch, Late 2009)



Exploded Views

Display View

Important: Replace parts like-for-like. For parts with more than one part number, enter the product serial number in GSX to determine the compatible part.

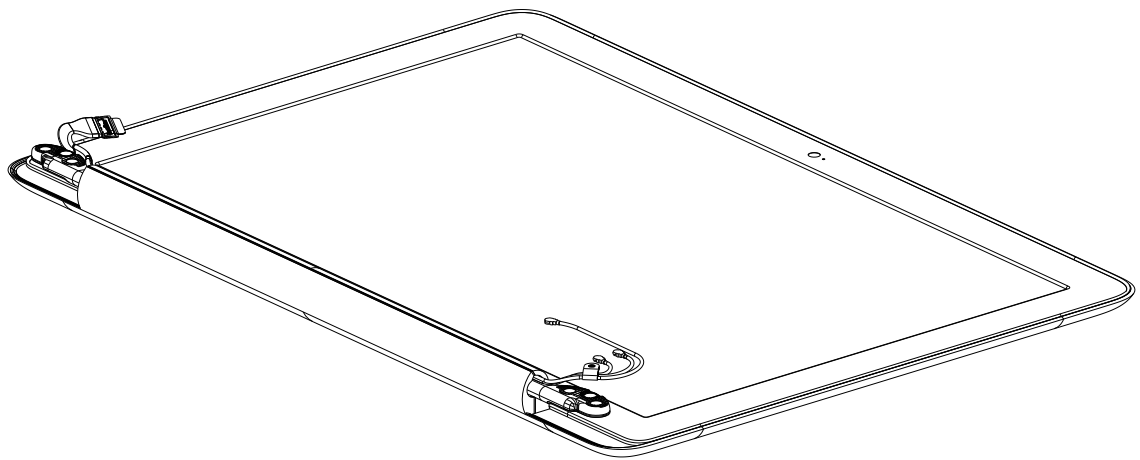

Display Module
661-5443
661-5588*

* Check the two serial numbers on the memory card carrier label. (Refer to [Logic Board](#) for label examples.) If the numbers are stacked (not side-by-side), order this display module. If the label is missing or for the most current information, **ALWAYS enter the product serial number in GSX to determine the compatible parts.**



MacBook (13-inch, Late 2009): Main View (side-by-side serial numbers)

Important: Parts shown are for reference and are not updated for changed build configurations. In most cases, you can check the two serial numbers on the memory card carrier, and if the numbers are side-by-side, use parts shown here. However, if the memory card label is blank or for the most current information, **ALWAYS enter the product serial number in GSX to determine the compatible parts.**

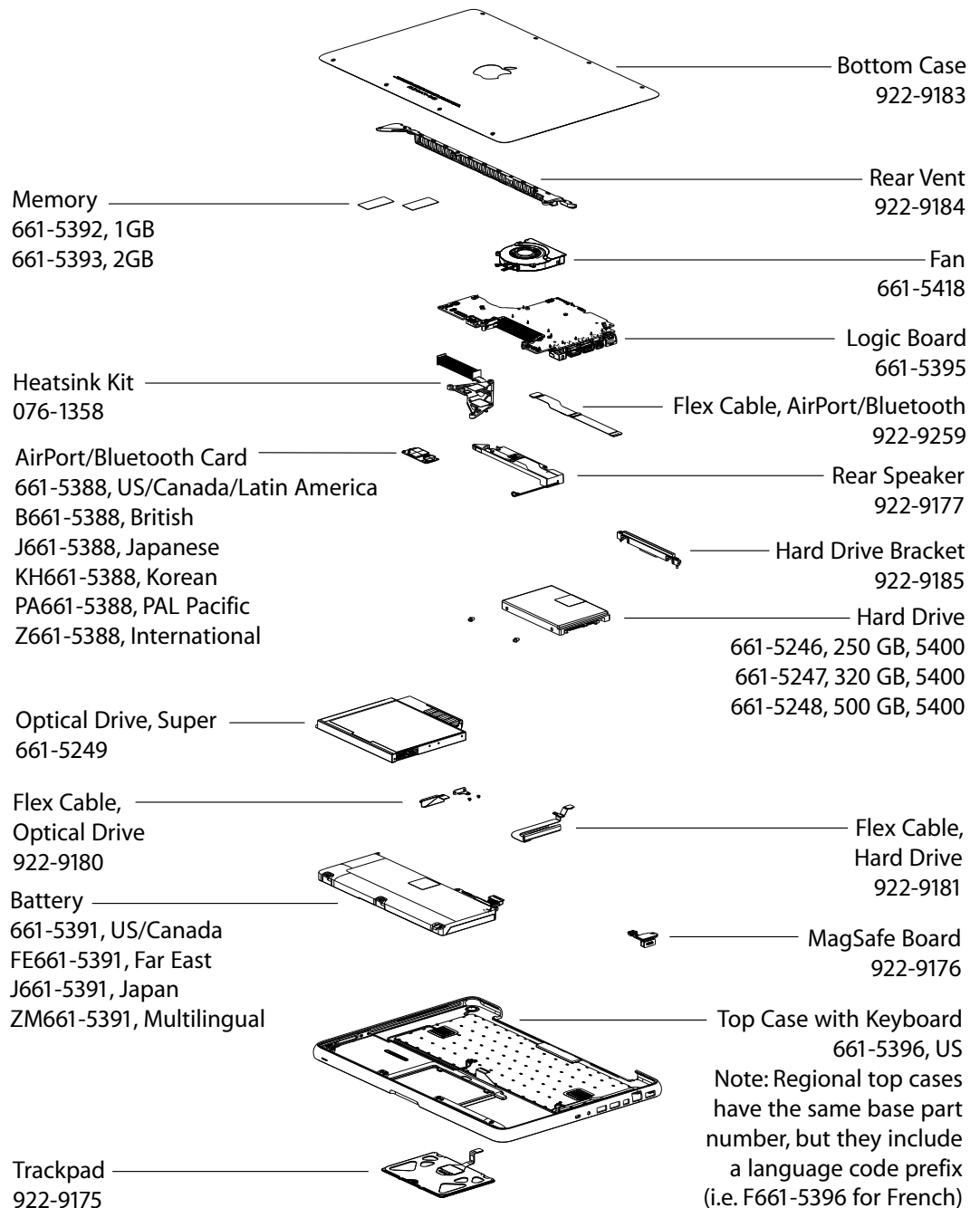



MacBook (13-inch, Late 2009): Main View (stacked serial numbers)

Important: Parts shown are for reference and are not updated for changed build configurations. In most cases, you can check the two serial numbers on the memory card carrier, and if the numbers are stacked, use parts shown here. However, if the memory card label is blank or for the most current information, **ALWAYS enter the product serial number in GSX to determine the compatible parts.**

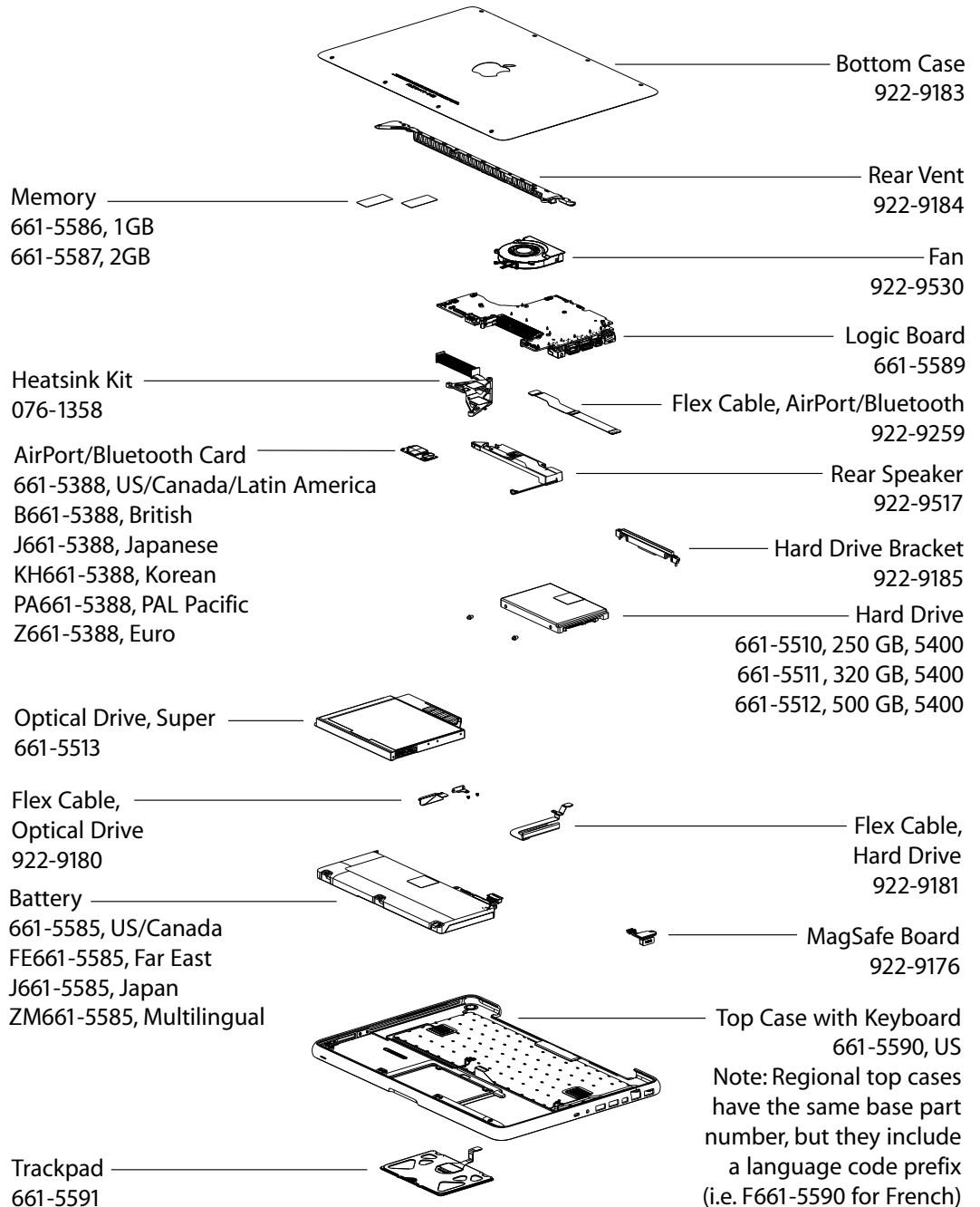



MacBook (13-inch, Mid 2010): Main View (stacked serial numbers)

Important: Parts shown are for reference and are not updated for changed build configurations. In most cases, you can check the two serial numbers on the memory card carrier, and if the numbers are stacked, use parts shown here. However, if the memory card label is blank or for the most current information, **ALWAYS enter the product serial number in GSX to determine the compatible parts.**

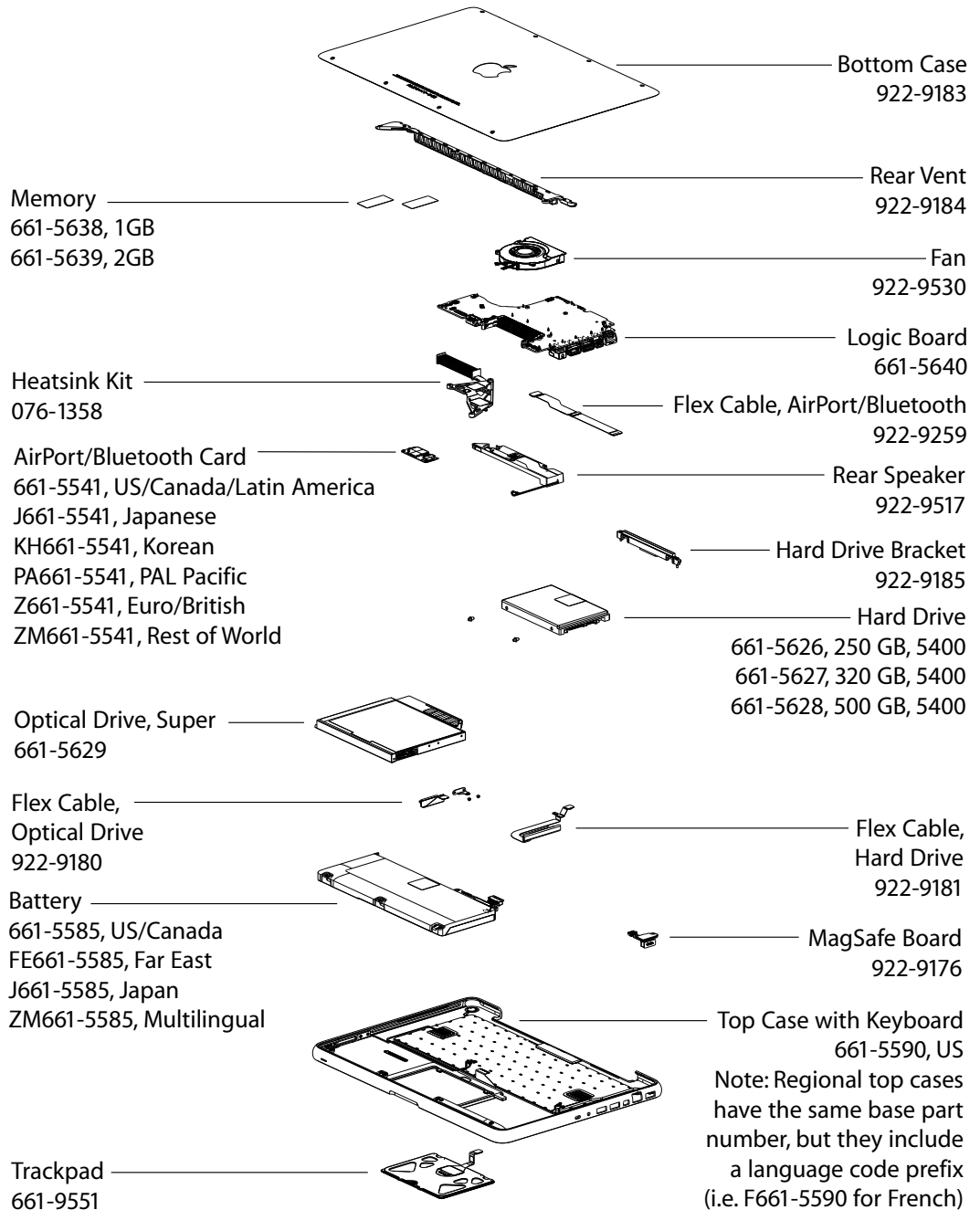



External Views

Front View





Rear View



Port View

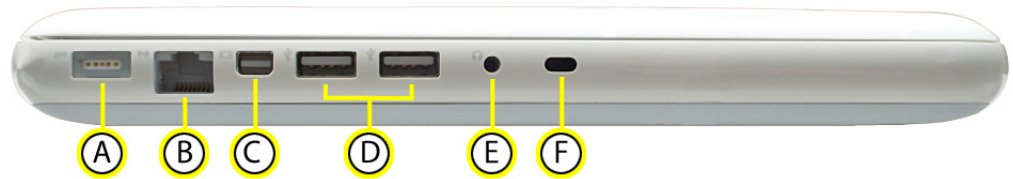

A = MagSafe Power

B = Gigabit Ethernet (10/100/1000 Base-T)

C = Mini DisplayPort (video out)

D = USB 2.0

E = Audio in/out

F = Security slot



Screw Locations

Bottom Case

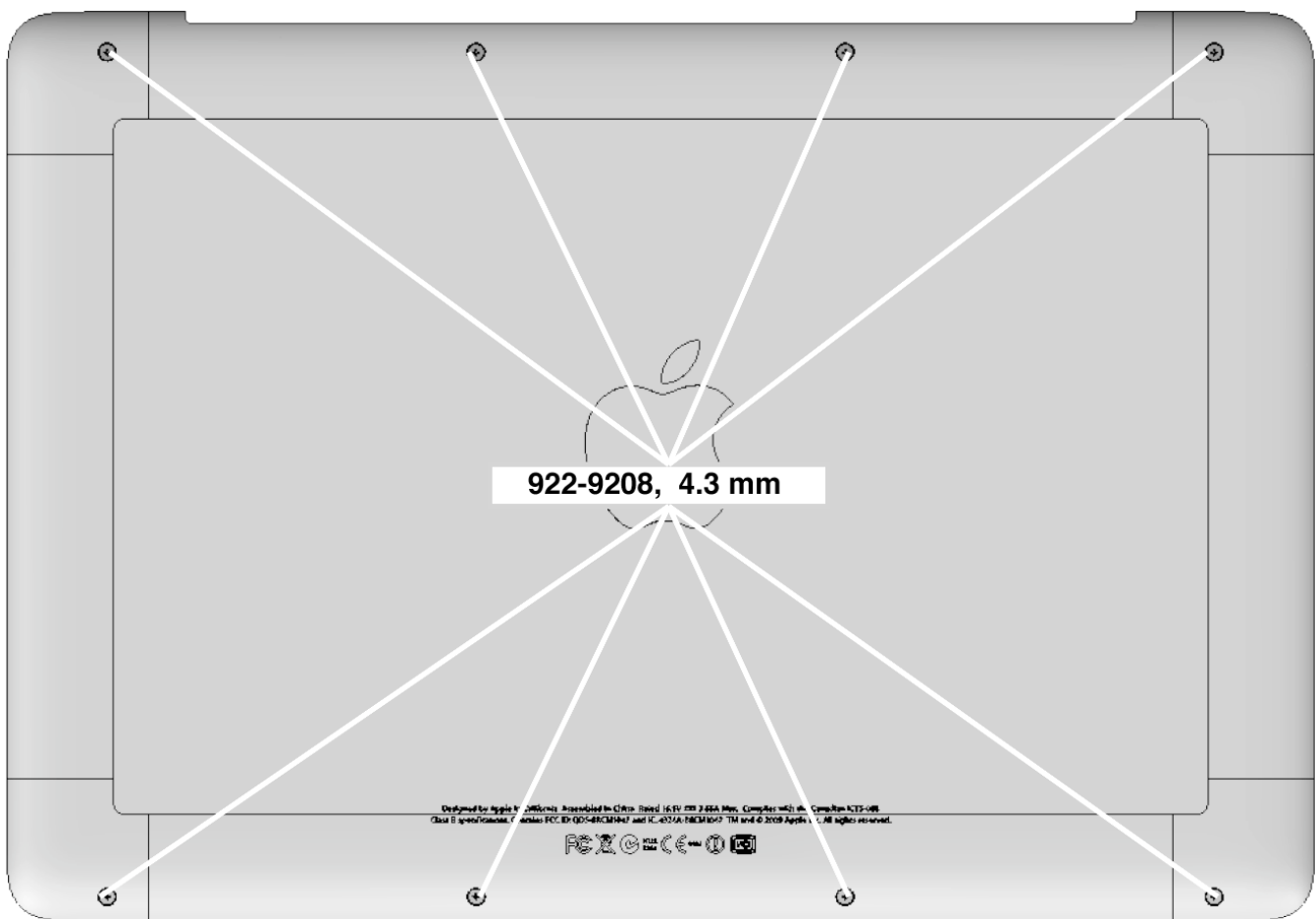



Battery, Rear Vent, Hard Drive Connector Cable

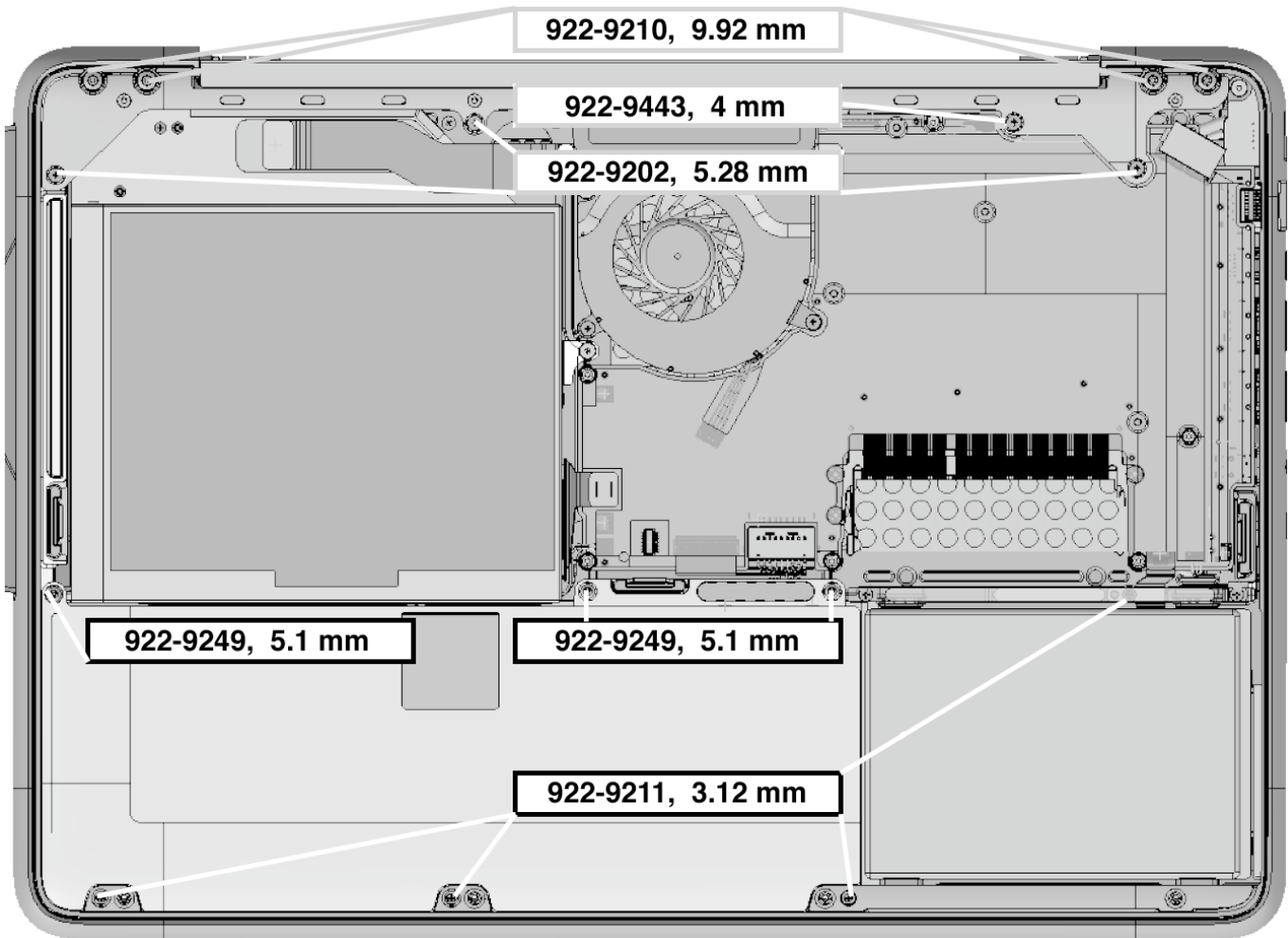

Note: If you have a torque driver, tighten the 922-9210 screws to 4.3 ± 0.17 inch pounds (5.0 ± 0.2 Kgf-cm)



Caution: Depending on the product serial number, the correct topmost battery screw is either 922-9249 or 922-9515. For the most current part information, **ALWAYS enter the product serial number in GSX to determine the compatible parts.**

Caution: Refer to [Rear Vent](#) to verify the correct screw shown at the 922-9443 screw location. Depending on the product serial number, the correct screw is either 922-9443 or 922-9202. Replace screws like-for-like.



Logic Board, Optical Drive, Speaker, Fan, MagSafe Board, Display

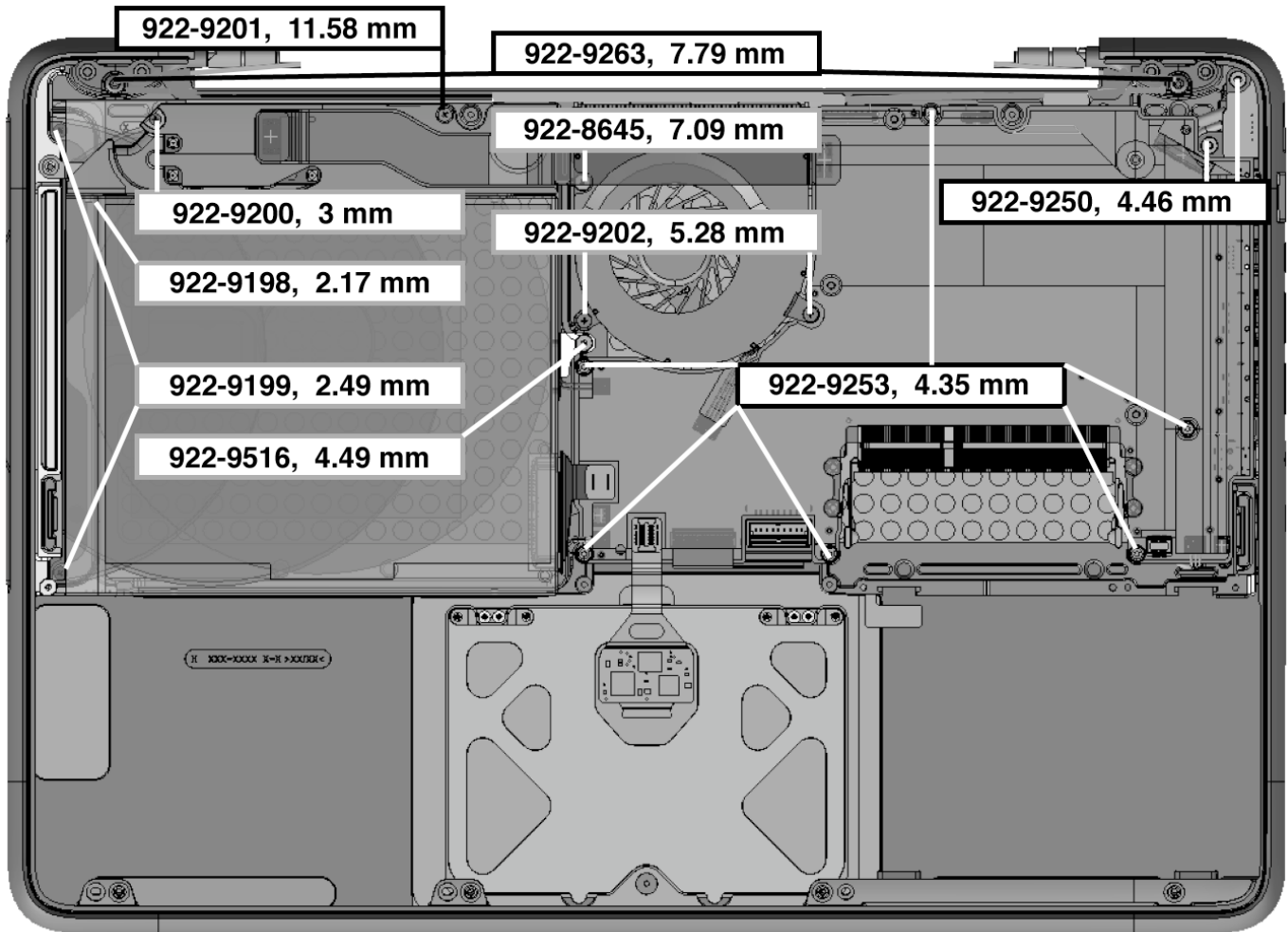

Note: If you have a torque driver, tighten the 922-9263 screws to 5.6 ± 0.17 inch pounds (6.5 ± 0.2 Kgf-cm)



AirPort/Bluetooth Card and Heatsink

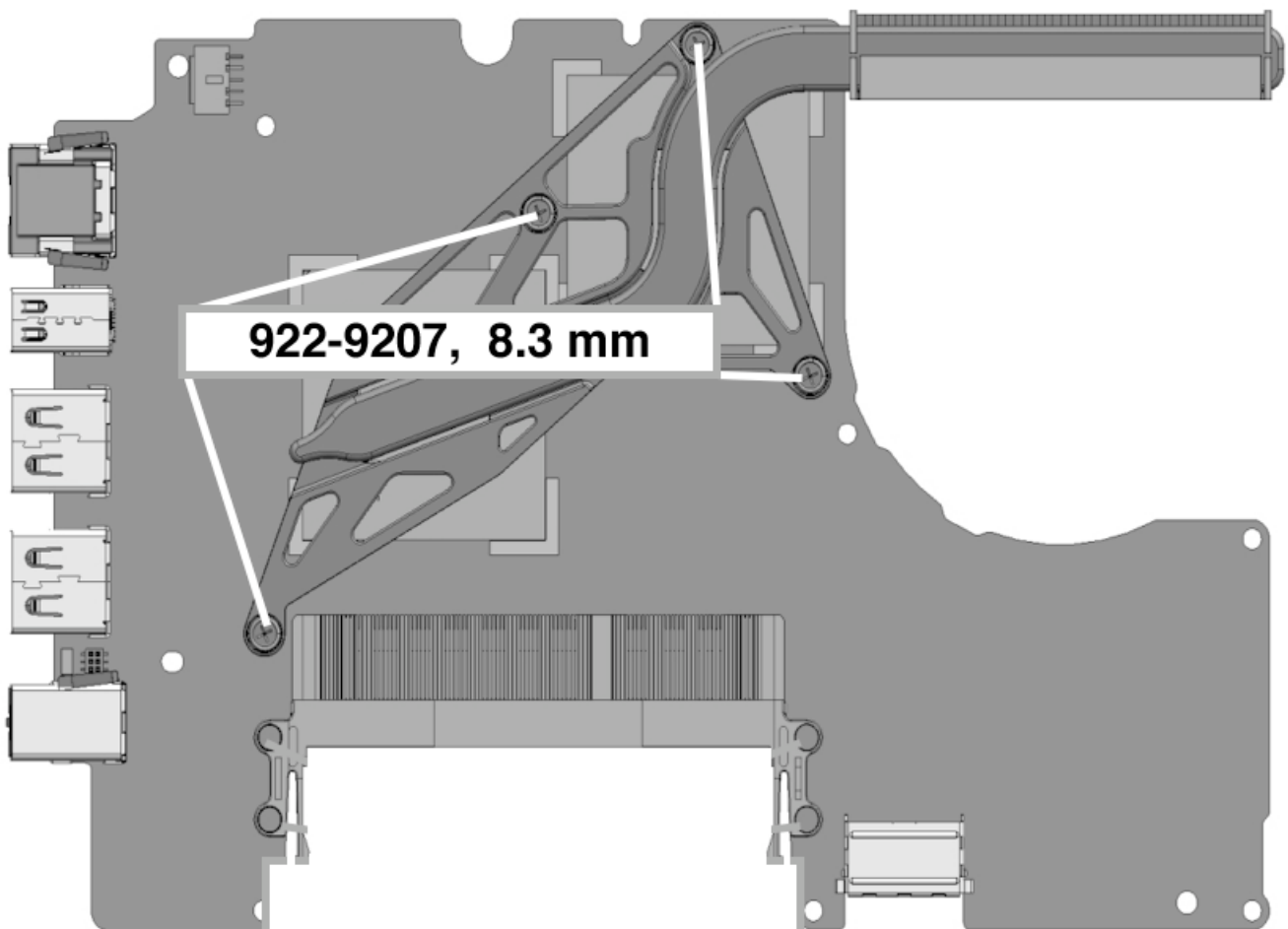
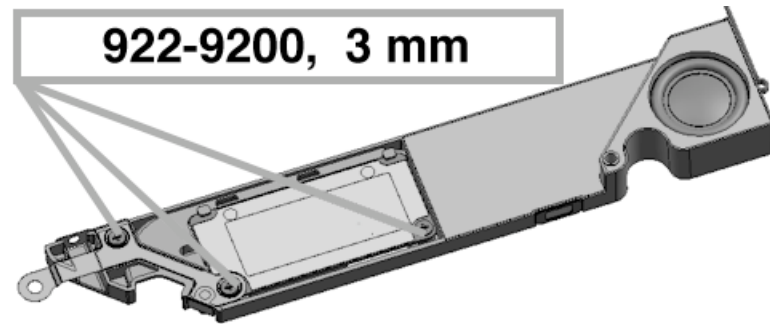



Top Case and Trackpad

