Apple Service Source



MacBook Pro 17-inch

(original, Core 2 Duo, 2.4GHz,
Late 2007 CTO, and Early 2008)

26 February 2008

 Apple Inc.

© 2008 Apple Inc. All rights reserved.

Under the copyright laws, this document may not be copied, in whole or in part, without the written consent of Apple.

Every effort has been made to ensure that the information in this document is accurate. Apple is not responsible for printing or clerical errors.

Apple
1 Infinite Loop
Cupertino, CA 95014-2084
USA
+ 1 408 996 1010
www.apple.com

Apple, the Apple logo, Mac, and Macintosh are trademarks of Apple Inc., registered in the U.S. and other countries.

MacBook Pro 17-inch

(all models)

Contents

Basics

General Information	7
Product View	7
Overview	7

Take Apart

Foot	15
Battery	18
Memory	20
Replacement Procedure	23
Top Case	25
Replacement Procedure	30
Keyboard	35
Replacement Procedure	50
AirPort Extreme Card	59
Hard Drive	64
Bluetooth Card and Antenna	69
Infrared Board	75
Replacement Procedure	77
Optical Drive	79
Handling Slot-Load Optical Drives	84
Replacement Procedure	87
Removing a Stuck Disc from an Optical Drive	88
Backup Battery	90
Ambient Light Sensors	95

Speakers and Microphone 97

Left I/O Board 103

ExpressCard Cage 110

Fans 111

Logic Board 118

Replacement Procedure 128

Battery Cable Assembly 135

Thermal Sensors 137

Heatsink 141

Bottom Case 143

Display Assembly 145

Replacement Procedure 148

Adjustments

Latch Adjustment 152

Troubleshooting

General Information 156

Wire and Flex Cables 156

Microphone and Camera wires 157

Hardware Diagnostics 157

Troubleshooting Aids and Tips 159

MacBook Pro Firmware Updates 161

Software Troubleshooting Tips and Tools 162

Troubleshooting Steps 165

Hardware Symptoms 168

How to Use the Symptom Charts 168

Startup 168

AirPort Extreme 174

Battery 175

Bluetooth 177

Display 178

ExpressCard/34 179

Hard Drive 180

Apple Remote 181

Infrared Board 182
Built-in iSight Camera 183
Keyboard 184
Microphone 185
Modem (External) 185
Optical Drive 187
Ports 188
MagSafe Power Adapter 189
Sound 190
Trackpad 191
Video 192
Miscellaneous Symptoms 193

Architecture 196

Views

MacBook Pro (17-inch original) Exploded View 198
MacBook Pro (17-inch Core 2 Duo) Exploded View 199
MacBook Pro (17-inch 2.4GHz) Exploded View 200
MacBook Pro (17-inch Early 2008) Exploded View 201
Screw Chart 202-203

Apple Service Source



Basics

MacBook Pro 17-inch
(original, Core 2 Duo, 2.4 GHz,
Late 2007 CTO, and Early 2008)



General Information

Product View



Overview

The MacBook Pro 17-inch family (original, Core 2 Duo, 2.4GHz and Early 2008) represents four generations of Apple's Intel-based professional 17-inch portables. The original MacBook Pro 17-inch had an Intel Core Duo chip, the 17-inch (Core 2 Duo and 2.4GHz) had successive Intel Core 2 Duo chips, and the newly introduced MacBook Pro (Early 2008) contains the new Intel Penryn chip, .

The Intel Penryn architecture supports faster clock speeds of 2.5GHz with a 6MB Shared L2 cache, plus a configured-to-order 2.6GHz with a 6MB Shared L2 cache, with VRAM increased to 512MB. Two new hard drive sizes include 200GB/7200 RPM and 300GB/4200RPM.

Other new features include: a user-friendly multi-touch trackpad, an updated keyboard layout, and a hi-res LED-driven display backlight (configured-to-order option). With an LED backlight and Halogen-free components, this line continues Apple's commitment to a "Greener Apple."

The only visual differences among models are a small LED opening in the display bezel of the original MacBook Pro, and new keyboard icons on the recent MacBook Pro (17-inch Early 2008).

Main service and feature differences among 17-inch MacBook Pro models:

	MacBook Pro (17-inch Early 2008)	MacBook Pro (17-inch 2.4GHz + Late 2007 2.6GHz CTO*)	MacBook Pro (17-inch Core 2 Duo)	MacBook Pro (original 17-inch)
Intro Date	February 26, 2008	June 5, 2007 / Nov 1, 2007	October 24, 2006	April 24, 2006
Micro-processor	2.5GHz Penryn and 2.6GHz (CTO)	2.4GHz Core 2 Duo + *2.6GHz CTO (Late 2007)	2.33GHz Core 2 Duo	2.16GHz Core Duo
L2 Cache	6MB shared (1:1)	4MB shared (1:1)	4MB shared (1:1)	2MB shared (1:1)
Bus Speed	800 MHz	800 MHz	667 MHz	667 MHz
Max RAM	4 GB	4 GB	3 GB	2 GB
Hard Drive(s)	250GB, 5400 RPM 300GB, 4200 RPM (CTO) 200GB, 7200 RPM (CTO)	160GB, 5400 RPM 200GB, 4200 RPM (CTO) 160GB, 7200 RPM (CTO) *250GB, 5400 RPM (CTO) *200GB, 7200 RPM (CTO)	160GB, 5400 RPM 100GB, 7200 RPM (CTO) 200GB, 4200 RPM (CTO)	120GB, 5400 RPM 100GB, 7200 RPM (CTO)
Graphics Chip	NVIDIA GeForce 8600M GT w/ 512MB VRAM	NVIDIA GeForce 8600M GT w/ 256MB VRAM	ATI x1600	ATI x1600
Display	CCFL backlight, plus CTO LED backlit hi-res model	CCFL backlight	CCFL backlight	CCFL backlight
Optical Drive	8x DVD Dual Layer Superdrive	8x DVD Dual Layer Superdrive	8x DVD Dual Layer Superdrive	8x DVD Dual Layer Superdrive

New Parts and Procedures

AirPort Card

A new 802.11n Broadcom AirPort card uses two antenna wires instead of three. Note that the card may have a Kapton shield covering as shown below.

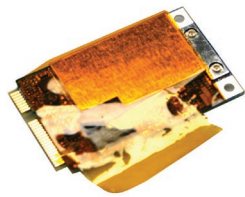

Bluetooth 2.1

A new Broadcom-based Bluetooth module upgrades the to Bluetooth 2.1.

USB Ports

USB ports are now high-current (1.1 amp) ports.

Halogen-free Components

New, environmentally friendly Halogen-free materials tend to be stiffer and less pliable, and thus require careful handling to avoid damage.

Keyboard Changes

The new keyboard layout on the MacBook Pro (17-inch Early 2008) differentiates it from all previous 17-inch MacBook Pro models.

MacBook Pro (17-inch original, Core 2 Duo and 2.4GHz) keyboard



MacBook Pro (17-inch Early 2008) keyboard



New keyboard features

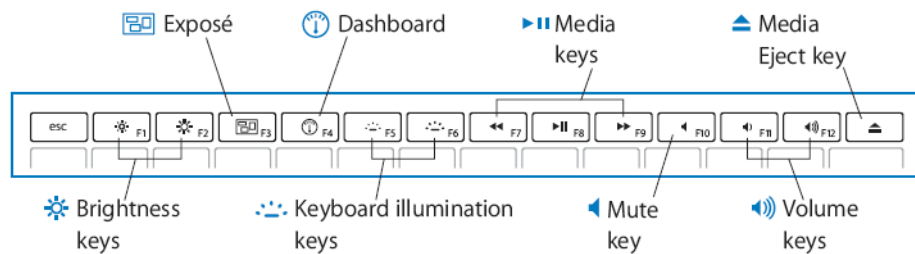

Using the Multi-Touch Trackpad

Use the trackpad to move the pointer and to scroll, tap, double-tap, and drag. How far the pointer moves on screen is affected by how quickly you move your finger across the trackpad. To move the pointer a short distance, move your finger slowly across the trackpad; the faster you move your finger, the farther the pointer moves. To fine-tune the tracking speed and set other trackpad options, choose Apple > System Preferences, click Keyboard & Mouse, and then click Trackpad.

Existing trackpad tips and shortcuts

- *Forward deleting* deletes characters to the right of the insertion point. Pressing the **Delete** key deletes characters to the left of the insertion point.

To forward delete, hold down the Function (fn) key while you press the Delete key.

- *Secondary clicking* or “right-clicking” lets you access shortcut menu commands.

To secondary click, place two fingers on the trackpad while clicking the trackpad button. If Tap to Click is enabled, just tap two fingers on the trackpad.

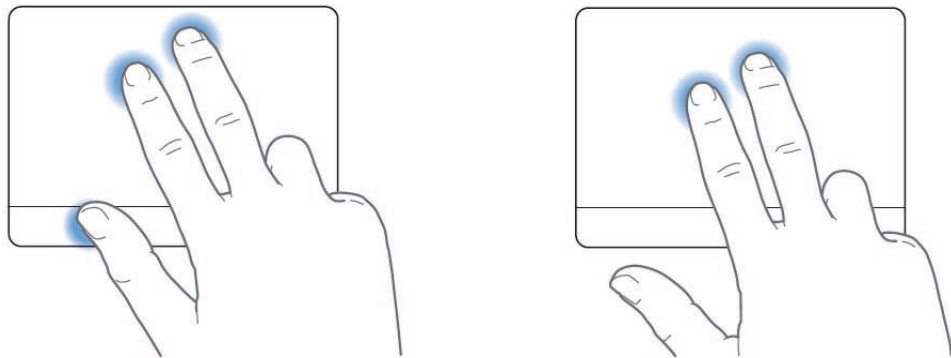

You can also secondary click by holding down the Control key while you click.

- *Two-finger scrolling* lets you drag to scroll quickly up, down, or sideways in the active window. This option is on by default.

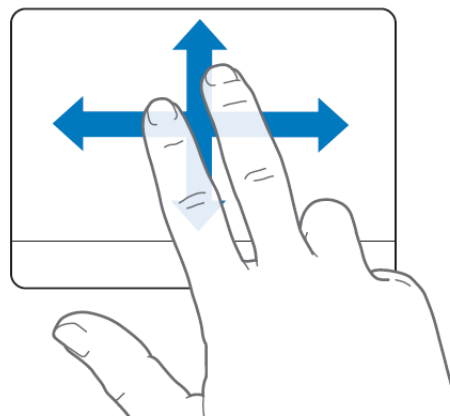

New trackpad gestures: pinching, rotating and swiping

The following trackpad gestures work in certain applications, such as Preview or iPhoto. For more information, choose Help > Mac Help and search for “trackpad.”

- *Two-finger pinching* lets you zoom in or out on PDFs, images, photos, and more.

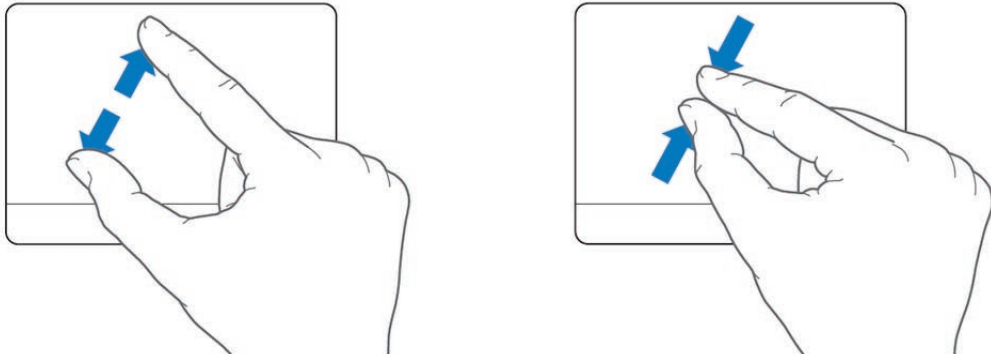

- *Two-finger rotating* lets you rotate photos, pages, and more.

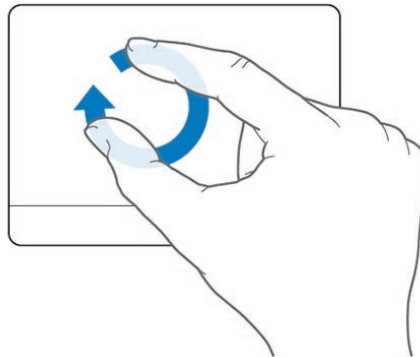

- *Three-finger swiping* lets you rapidly page through documents, move to the previous or next photo, and more.

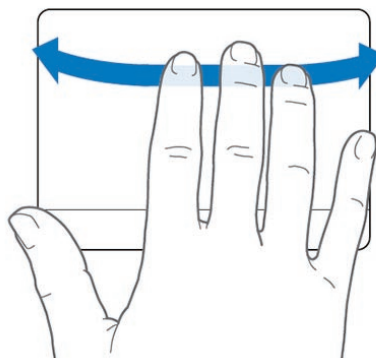

Note: Using a multi-page document in Preview will allow you to practice all three features.

Serial Number and Ethernet ID

The Serial Number and Ethernet ID are located in the battery bay.

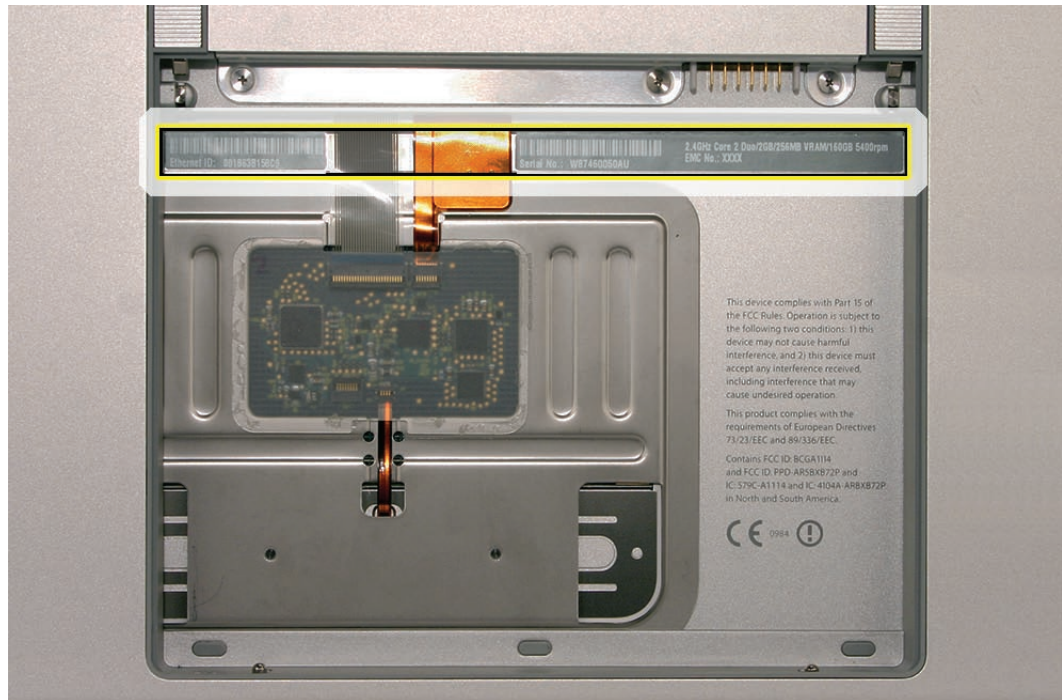

Tools

The takeapart procedure for the MacBook Pro (17-inch Early 2008) requires the following tools:

- Clean non-marring work surface
- ESD wrist strap and mat
- Multi-compartment screw tray (such as a plastic ice cube tray)
- #0 Phillips screwdriver (magnetized)
- #1 Phillips screwdriver (magnetized)
- Torx T6 screwdriver (magnetized)
- 4 mm socket wrench
- Black stick (nylon probe 922-5065) or other non-conductive nylon or plastic flat-blade tool
- Razor knife
- Needle-point metal probe
- Needlenose pliers
- Tweezers
- Kapton tape (922-1731) (0.5-inch x 12-yard roll)
- Thermal grease (922-7144)
- Gasket kit (076-1281)
- Alcohol pads
- Fine-point felt-tip permanent marker
- Apple Pro keyboard and mouse (for troubleshooting)

Display Takeapart

The MacBook Pro (17-inch Early 2008) continues the whole display clamshell solution as the replacement part for any display failures or components contained within the clamshell.

Electrostatic Discharge (ESD)

Use a properly grounded ESD wrist strap and mat when working on the inside of the computer.

Service Manual Note

In this manual, graphics or photos are intended to help illustrate procedures or information only, and may show different levels of disassembly, board colors, configurations, or computer models, than your computer.

Kapton® Tape Note

Kapton tape is used to secure cables and connectors where necessary.

During disassembly, note any Kapton tape use and locations—reapply in the same manner. Do not over apply or build up tape on top of old tape; space tolerances are tight and build up or extraneous use of tape may cause pressure on other components.

Cable Routing Note

With the MacBook Pro's one-inch enclosure height, the placement of parts and wiring is critical.

During disassembly, note cable routing. Reassemble in the same manner. Verify that cables do not route over components when they should route into lower positions or channels. Verify that the cables are not strained or applying pressure onto other components.

Screw Measurement Note

All screw measurements given are the specified full length. Actual measured lengths may vary.

Temperature Concerns

The customer may perceive this system to run hotter than previous models. However, the normal operating temperature is well within national and international safety standards. Still, customers may be concerned about the heat generated by their machine. To prevent an unnecessary repair, you can compare a customer's computer to a running model, if available, at your repair site.

For more information on temperature concerns and customer perception, refer to Knowledge Base article 30612: Apple Portables: Operating Temperature.

Apple Service Source



Take Apart

MacBook Pro 17-inch
(original, Core 2 Duo, 2.4 GHz,
Late 2007 CTO, and Early 2008)



Foot



Tools

This procedure requires the following tools:

- Foot kit
- Tweezers or needlenose pliers
- Soft cloth

Preliminary Step

Before you begin, check the foot location that needs replacement and verify that the case plug is attached. Also verify that the case plug, and the case foot in the kit, match the pictures below.

Plug Area on Bottom Case	Matching Foot	Action
Missing case plug 	Not available for replacement	Replace the bottom case, or send to Apple Repair Center.
Case plug (either one) 	Case foot 	Continue with the procedure, matching the foot to either plug on the bottom case.

Procedure

Warning: The glue used in this procedure can bond instantly to skin. Do not touch the glue. In the event of contact, review the safety instructions at the end of this document. For additional information, refer to the glue manufacturer:

Elmer's Products, Inc.
Columbus, OH. 43215-3799
www.krazyglue.com

1. Place the computer upside down on a clean, lint-free cloth or other nonabrasive surface.
2. Select a foot from the kit. Verify that the case plug and case foot match (refer to the images shown in the table). Do not use a foot that does not match.
3. Make sure the plug area on the bottom case is clean. If any portion of the soft rubber foot remains, remove it so that only the hard plastic plug is visible.

Important: When positioning the foot, make sure the indents and bumps of the rubber foot match up and fit into the corresponding indents and bumps in the plug. This ensures a balanced and level fitting.

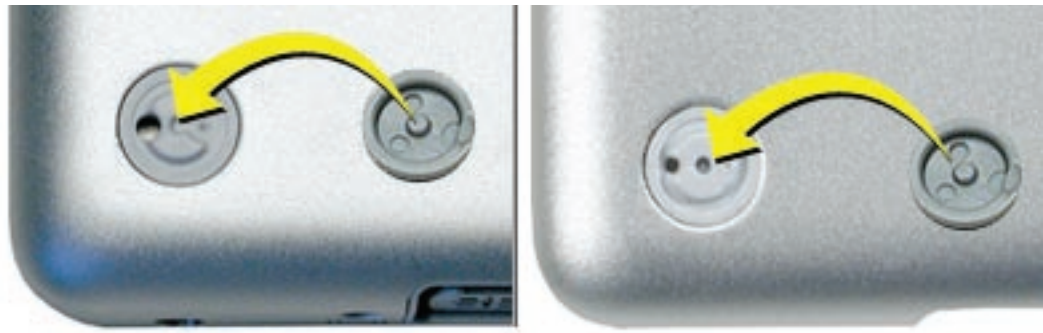

-
4. **Warning: GLUE IS AN EYE AND SKIN IRRITANT. BONDS SKIN INSTANTLY. Do not touch the glue at any time. Before opening the glue, review the safety instructions below.**

Important: The glue tube included in the kit is sealed until first use. Do not break the seal until you are ready to use the glue. To break the seal, hold the tube upright and away from you. Place the hollow nozzle cap on the tube and tighten it all the way down. The tube is then ready to dispense the glue through the nozzle cap.



5. Apply one drop of glue to the plug on the bottom case. Do not spread the glue.
6. Using tweezers or needlenose pliers, carefully position the new foot so its textured surface fits into the inner ring of the plug.
7. Using the end of the tweezers or pliers—not your finger—lightly press and hold the foot in place for 30 seconds.



8. Before turning over the computer, allow the glue to set for at least 15 minutes.
9. Discard the tube of glue.

SAFETY INSTRUCTIONS: GLUE IS AN EYE AND SKIN IRRITANT. BONDS SKIN INSTANTLY.

Contains ethyl cyanoacrylate. Avoid contact with skin and eyes. If eye or mouth contact occurs, hold eyelid or mouth open and rinse thoroughly but gently with water only for 15 minutes and GET MEDICAL ATTENTION. Liquid glue will sting eye temporarily. Solidified glue may irritate eye like a grain of sand and should be treated by an eye doctor.

If skin bonding occurs, soak in acetone-based nail polish remover or warm soapy water and carefully peel or roll skin apart (do not pull). Contact through clothing may cause skin burn. If spilled on clothing, flush with cold water. Avoid prolonged breathing of vapors. Use with adequate ventilation. KEEP OUT OF REACH OF CHILDREN.



Battery

Tools

This procedure requires the following tools:

- Clean non-marring work surface

Preliminary Steps

Warning: Always shut down the computer before opening it to avoid damaging its internal components or causing injury. After you shut down the computer, the internal components can be very hot. Let the computer cool down before continuing.

Part Location

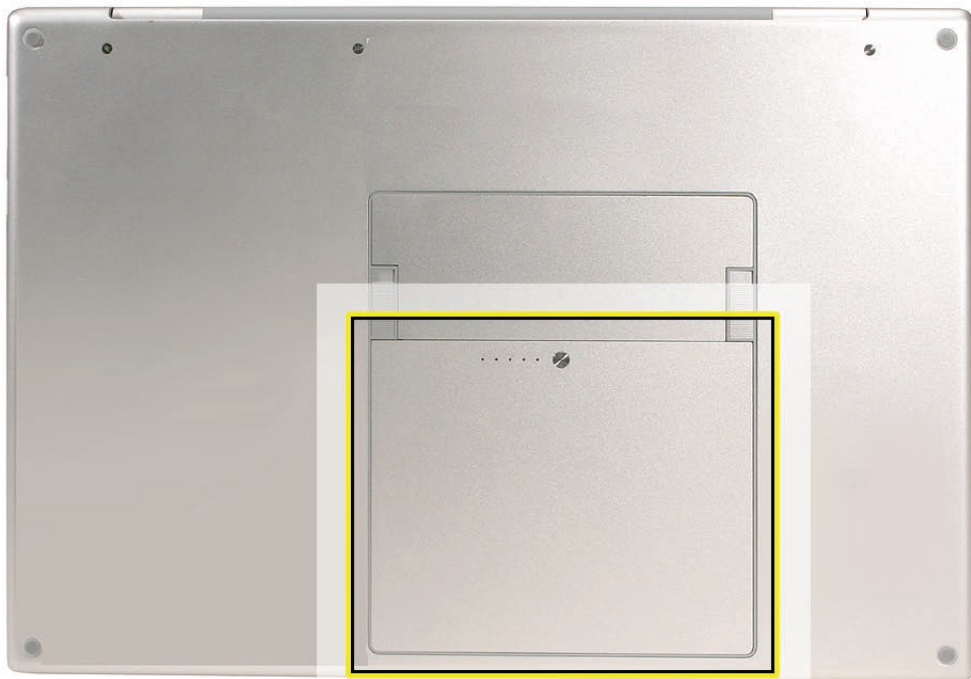

Procedure

Warning: If the computer has been recently operating, allow it to cool down before performing this procedure.

1. Shut down the computer.
2. Disconnect the power cord and any other cables connected to the computer.
3. Place the computer upside down.
4. Slide both battery latches away from the battery and lift the battery out of the battery bay.

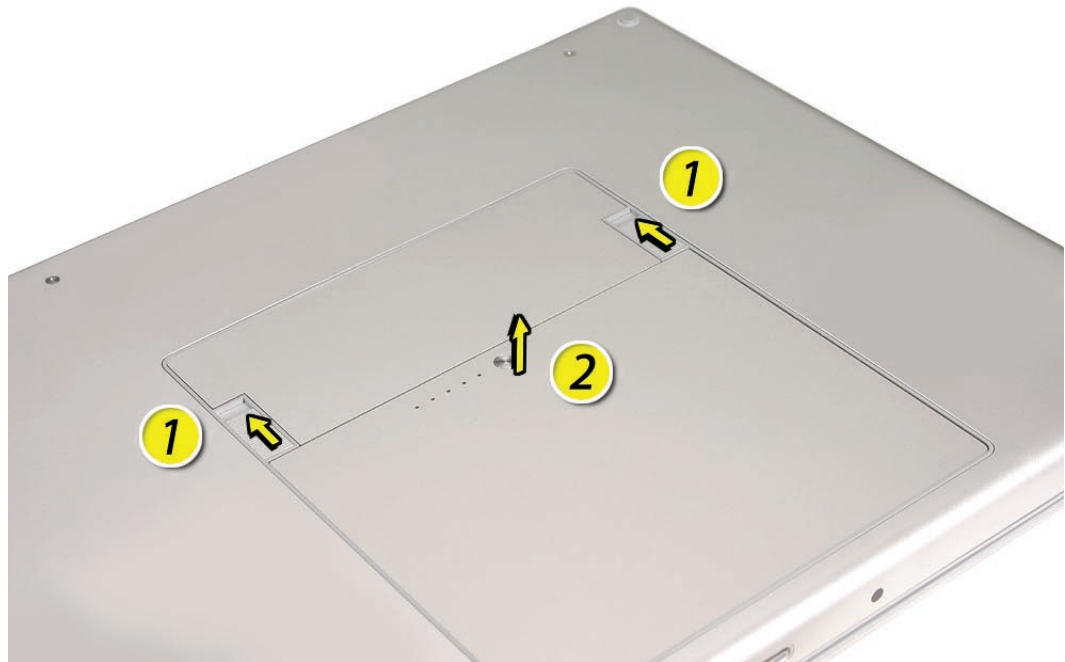



Memory

Tools

This procedure requires the following tools:

- #0 Phillips screwdriver (magnetized)
- Clean non-marring work surface
- ESD wrist strap and mat

Preliminary Steps

Before you begin, remove the following:

- [Battery](#)

Part Location



Procedure

Warning: If the computer has been recently operating, allow it to cool down before performing this procedure.

1. Place the computer upside down.
2. Remove four screws from the memory door.

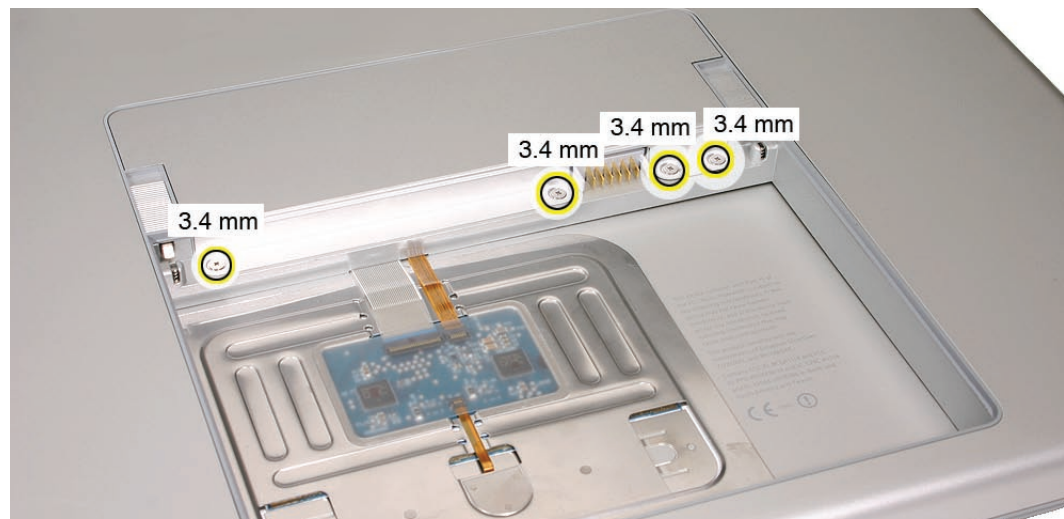

3. Remove the door, as shown.

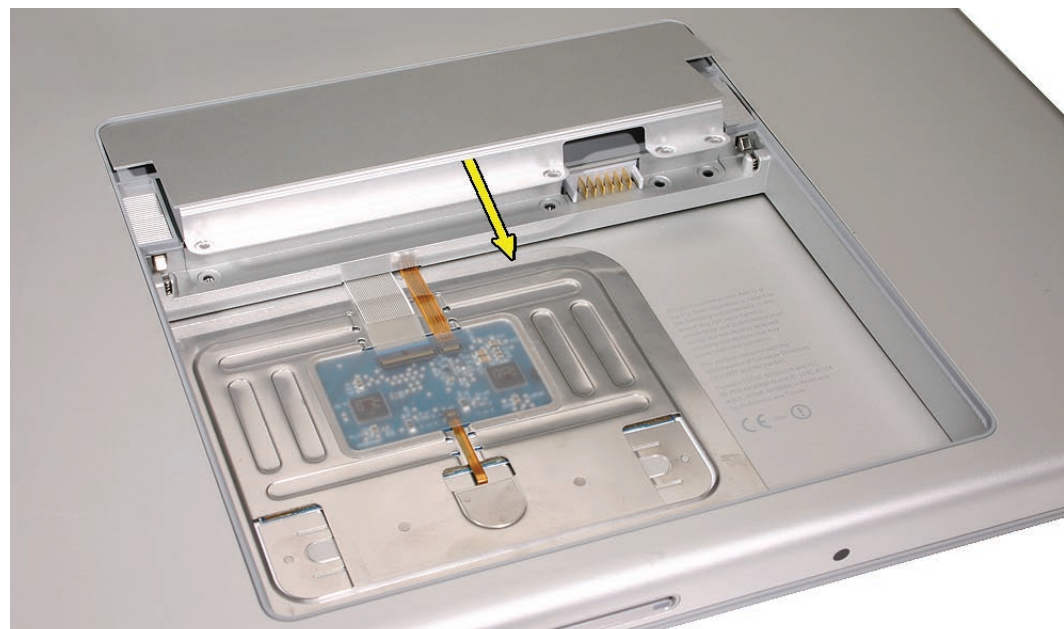

Notes:

- If only one memory card is installed, the factory installs it in the bottom memory slot.
- Memory must be removed from the top slot before removing from the bottom slot.

4. To remove memory cards, carefully spread the two locking tabs for the slot (top or bottom) away from the card on both sides and allow the card to pop up slightly.

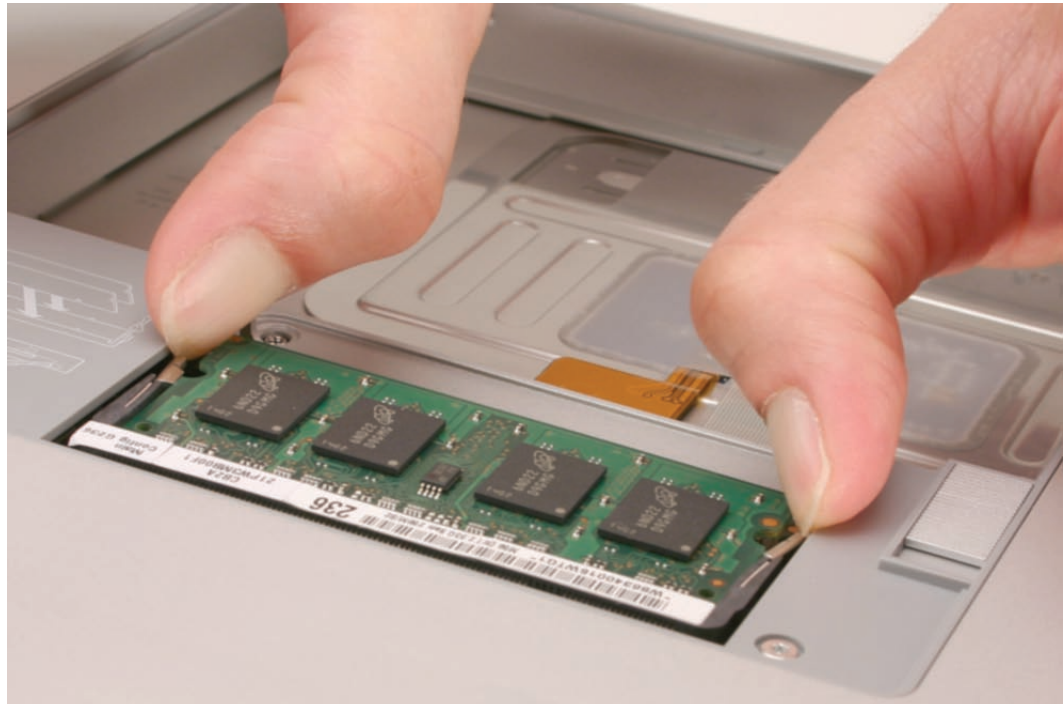

5. Pull the card straight back and out of the memory slot. Handle the memory card by the edges only, taking care not to touch the gold contacts.

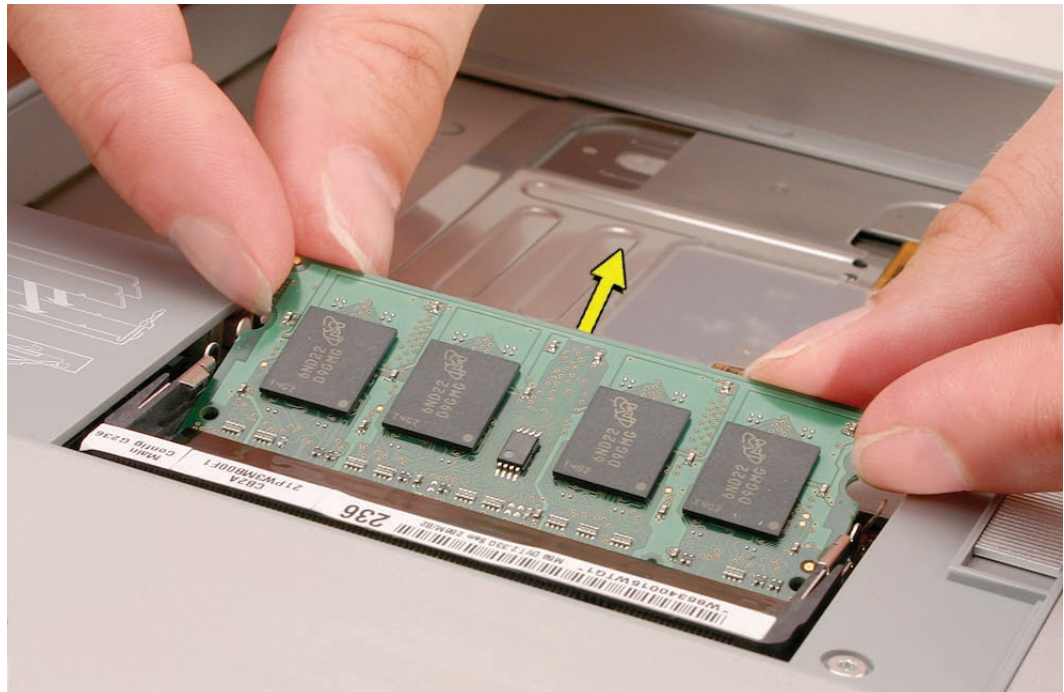

Replacement Procedure

Notes:

- DDR memory cards do not fit in this slot, only DDR2 (different notch location).
 - If installing two cards, install into the bottom slot first.
 - Align the notch in the memory card with the tooth in the slot before inserting.
1. To install memory cards, insert them at a 30-degree angle. **Note:** Insert the bottom card behind the locking tabs of the top slot.

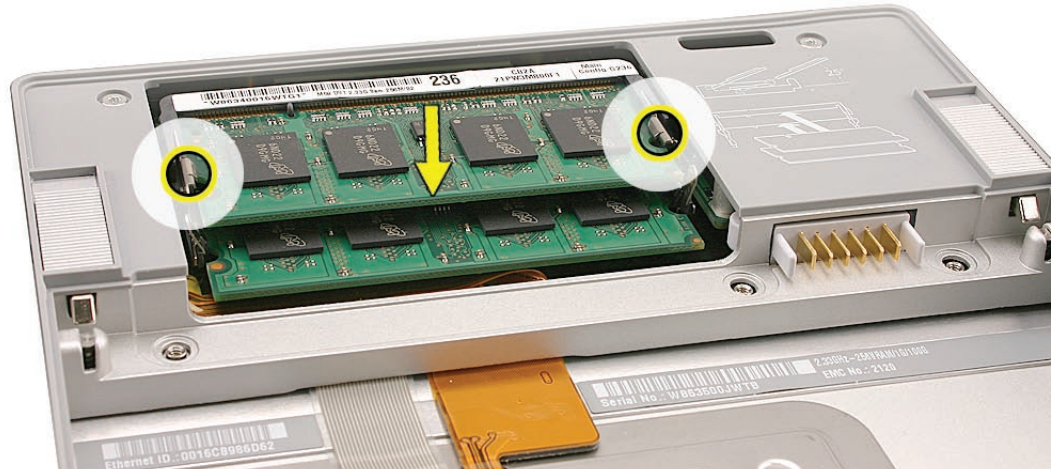

2. Firmly push the card straight into the slot until it is fully and securely seated along its length. **Note:** If the back of the card drops down before it is fully seated, raise it up enough to push it fully into the slot.
3. When the card is fully seated, push the card straight down until the tabs click onto both sides of the card, locking it into place.

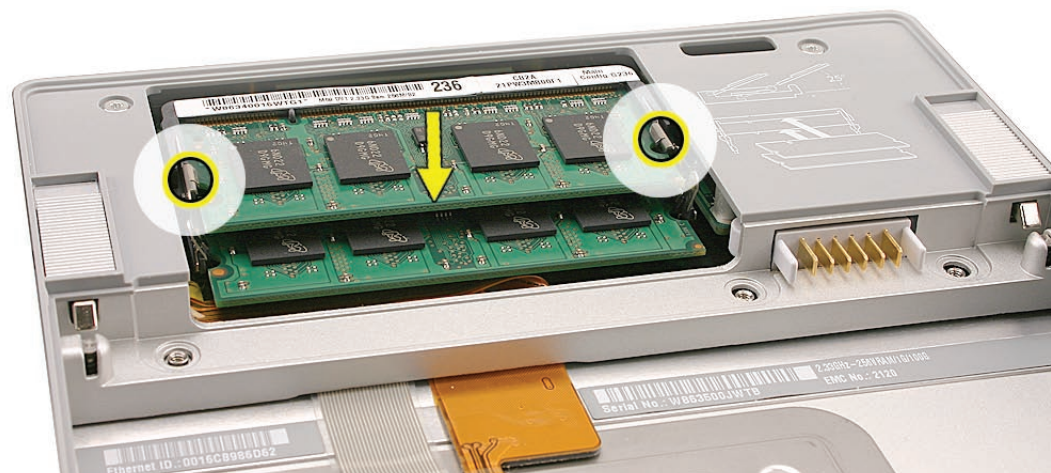

4. Verify that the card is fully seated by pushing firmly with your thumbs.

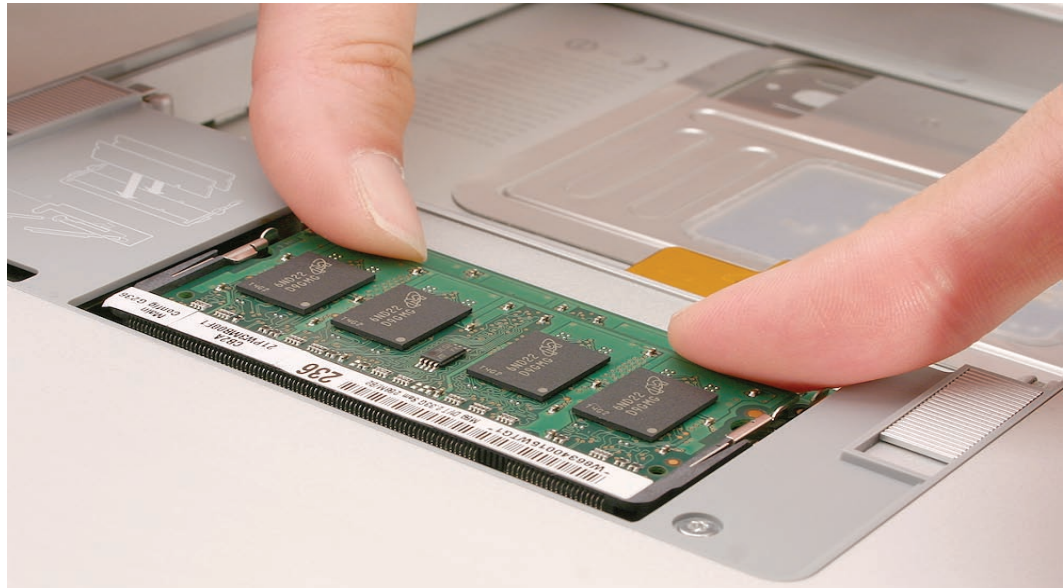

5. Check that the cards are secured by the brackets on both sides.
6. Install the memory door.
7. Replace the battery.
8. **Use Apple System Profiler to verify that the memory is recognized. (Choose the menu bar Apple logo () > About This Mac, click More Info..., select the System Profile tab, open the Memory Overview.)**

NOTE: The maximum supported amount of memory in the MacBook Pro (17-inch original) is 2GB, in the MacBook Pro (17-inch Core 2 Duo) is 3GB, and in the MacBook Pro (17-inch 2.4GHz and Early 2008) is 4GB.

Important: While the MacBook Pro (17-inch Core 2 Duo) will have a perfectly bootable system with two (2) 2GB RAM modules installed—and even About This Mac will report 4GB of installed memory—the system will only be able to address 3GB of that installed RAM.

See [MacBook Pro \(Core 2 Duo\): Memory Specifications](#) for more information.



Top Case

Tools

This procedure requires the following tools:

- #0 Phillips screwdriver (magnetized)
- Torx T6 screwdriver (magnetized)
- Black stick (nylon probe 922-5065) or other non-conductive nylon or plastic flat-blade tool
- Multi-compartment screw tray (such as a plastic ice cube tray)

Preliminary Steps

Before you begin, remove the following:

- [Battery](#)
- [Memory](#)

Part Location



Procedure

Notes:

- This procedure removes the top case and keyboard assembly. The keyboard is removable only after removing the top case.

1. Place the computer upside down.
2. Remove the nine screws shown.

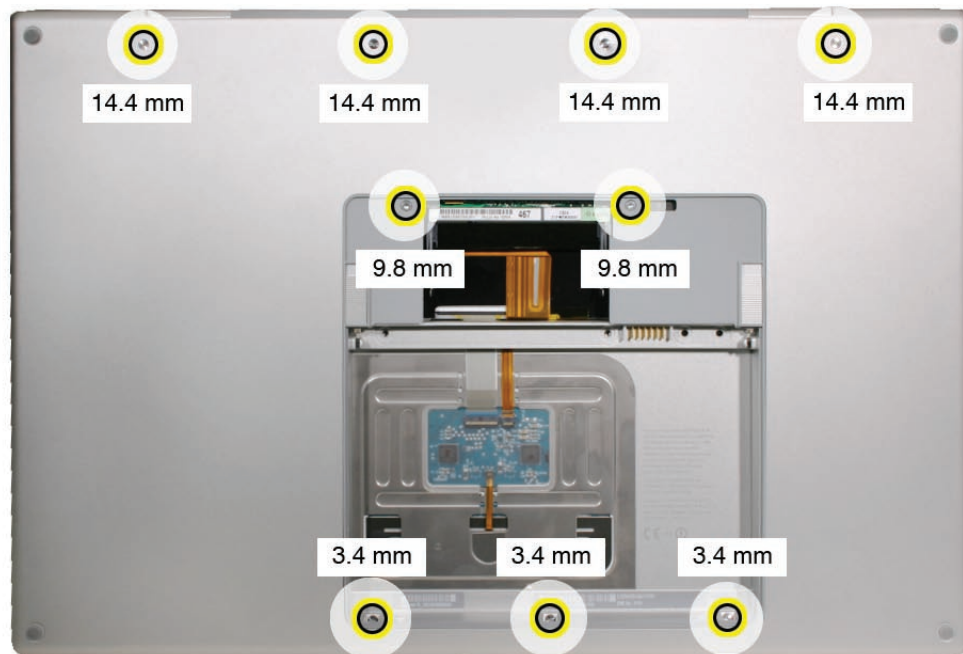

3. Remove the four screws from each side.



4. Remove the two screws from the back edge.



-
5. Face the computer toward you with the display open slightly past 90-degrees. Using your fingernails or the tips of your fingers, grasp just beneath the back edge of the top case behind the keyboard or in the upper right and left corners. Lift upward a few inches, then work your hands around the top case toward the front, slowly lifting and encouraging the clips and screw tabs to release. A snapping noise when the clips release is normal.



Note: Take care to preserve the cosmetic integrity of the plastic beading around the edges of the top case. If using a black stick for leverage to get the clips to release, don't rotate the stick too vigorously along the edges to avoid denting the soft plastic.

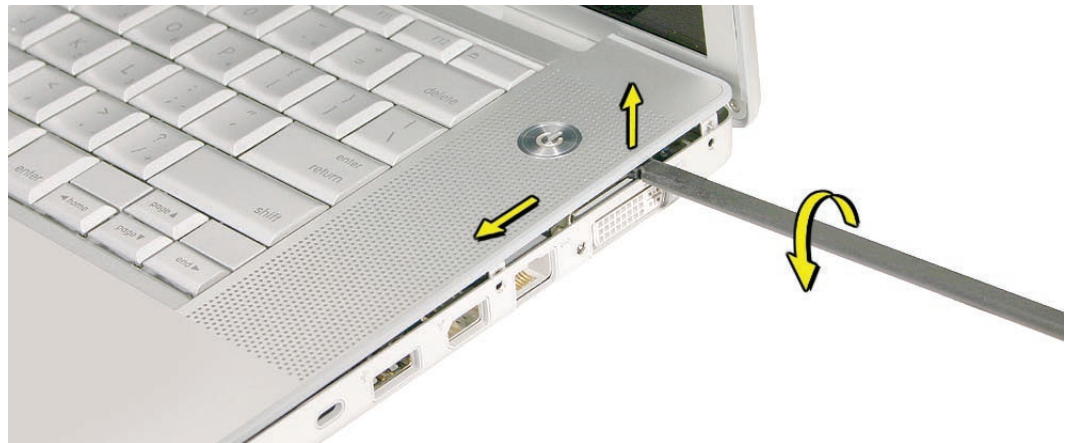

6. Along the front, start at the left and slowly encourage the snaps and screw tabs (shown in graphic below) to release as you move right. A snapping noise as the snaps release is normal. Again, take care to preserve the cosmetic integrity of the plastic beading around the edges by pulling up with your fingernails first. If a black stick is necessary to release the snaps, avoid too much rotation along the edges to keep from denting the soft plastic.

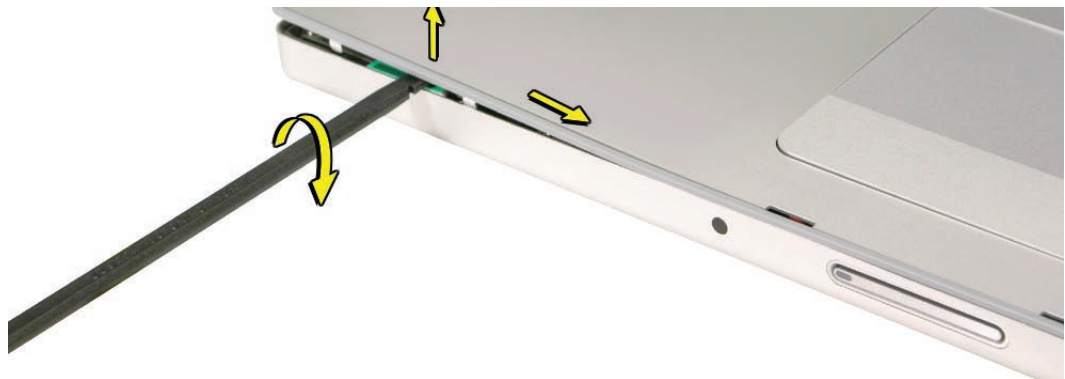

Important: Do not lift the case once it is free—it is still connected to the bottom case by the keyboard flex cable.

Important: To avoid bending screw tabs along the back edge of the top case, lift the top case slightly so that it does NOT touch the bottom case, then rotate the front of the case up and back until you can disconnect the keyboard flex cable from the logic board.

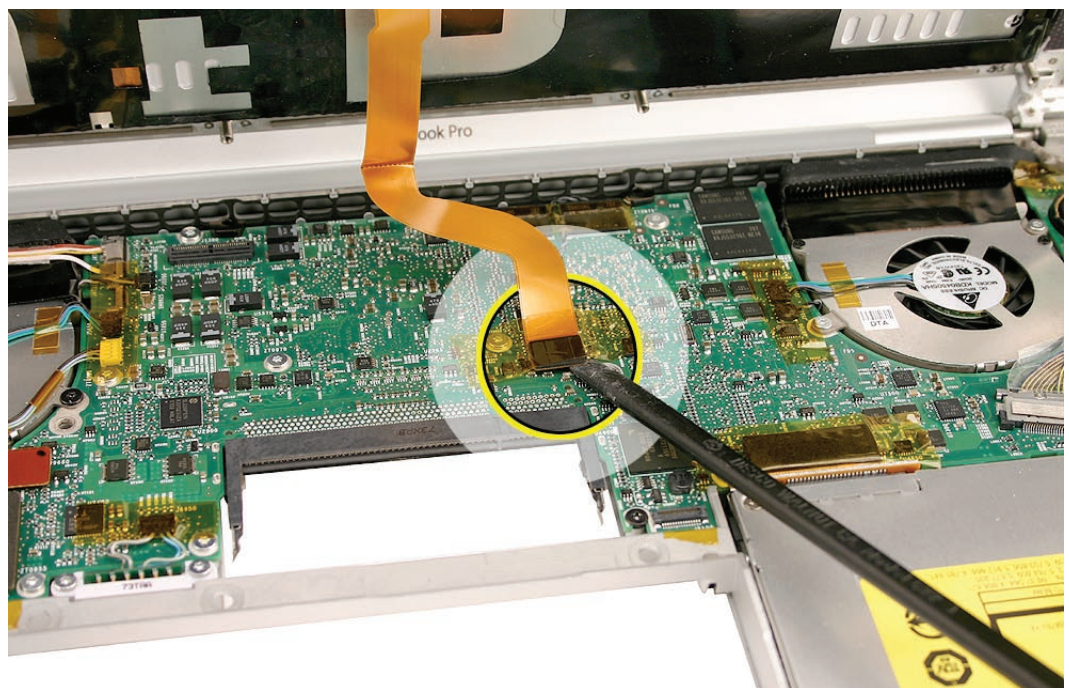
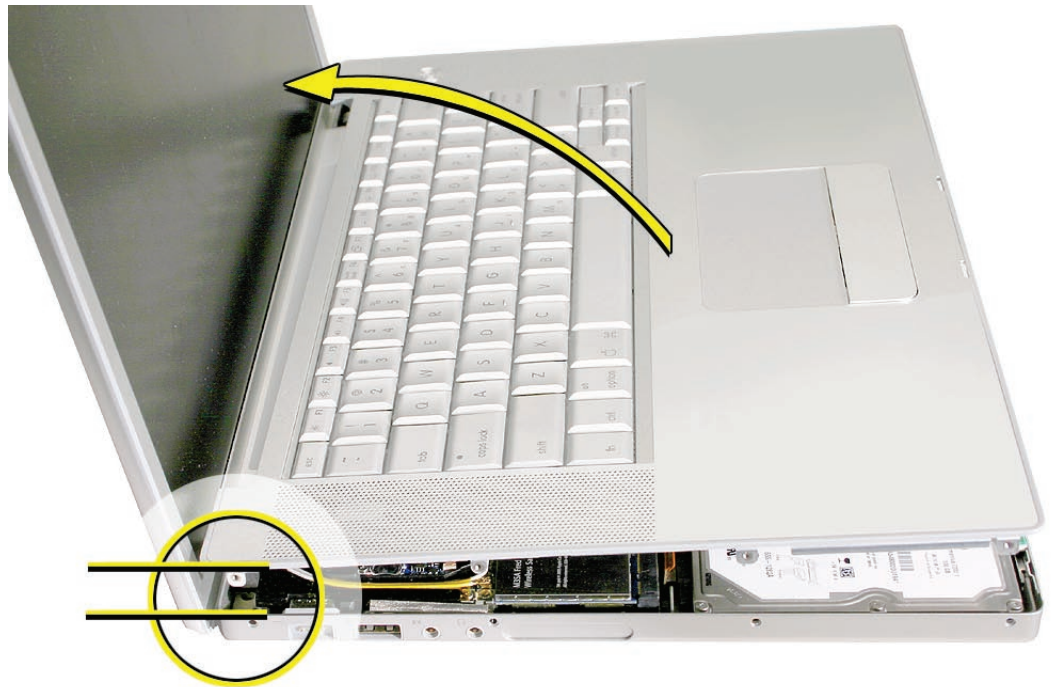

Replacement Procedure

Note: If replacing the top case, remove the [Keyboard](#) and transfer to the replacement top case.

1. Visually check to verify that all cables are connected and routed correctly with nothing raised up or incorrectly over a component.
2. Check perimeter wiring and cables around clutches to verify that they will not be caught or pinched by the top case during replacement.
3. On the computer, verify that all cables are secure and lay flat.
4. On the top case, check cable connections and routing.

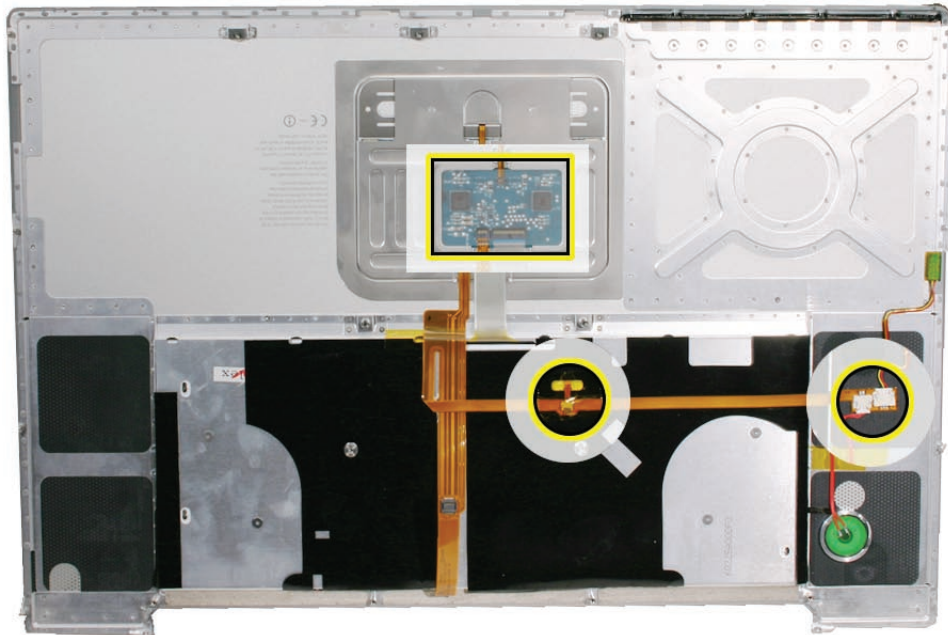

5. Check that the perimeter screw tabs and ribs are not bent.

Note: The metal can quickly fatigue and break off. Be extremely careful to gently straighten tabs, if needed.

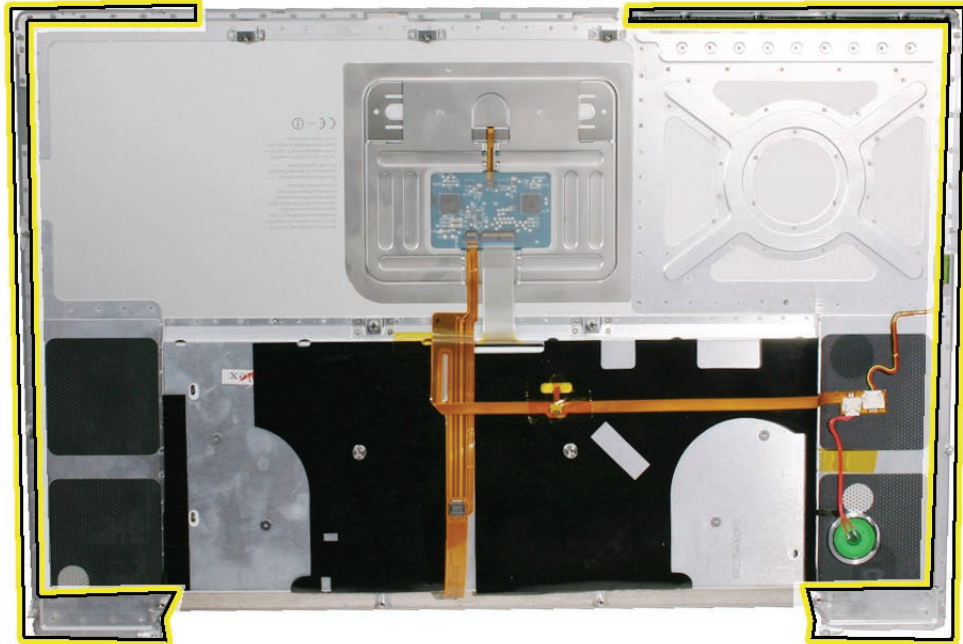

6. Verify that the screw tabs in back are straight and guide them inside the bottom case. Work your way around guiding the screw tabs into the bottom case along both sides.

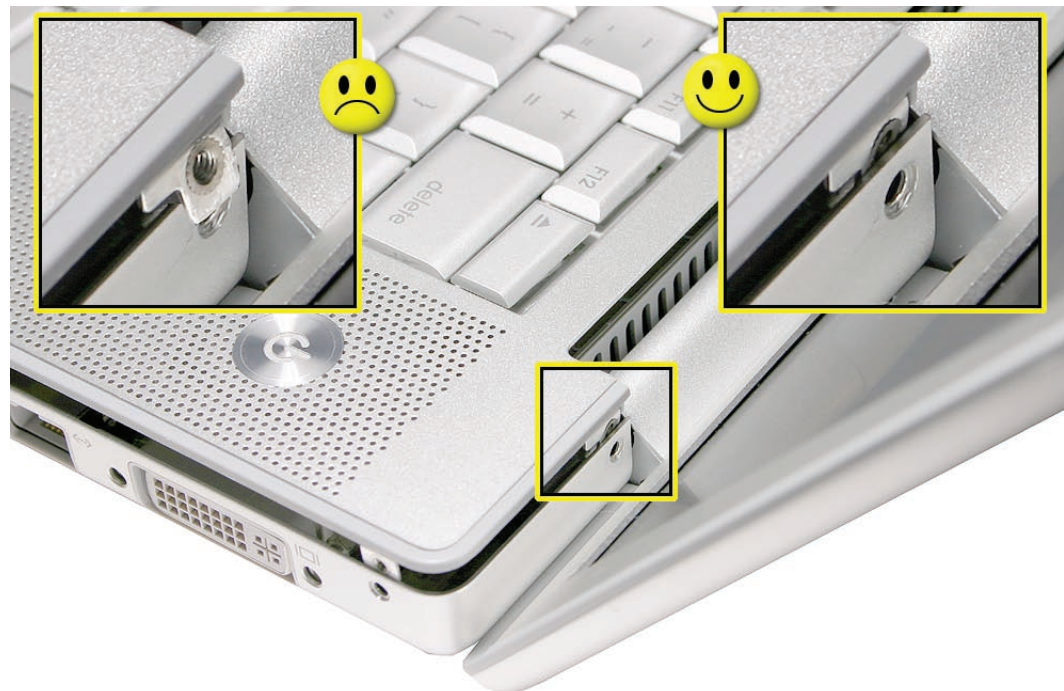

-
7. If the back screw tabs are bent out, straighten by pressing the edge of the case on a hard flat surface and rolling to vertical.

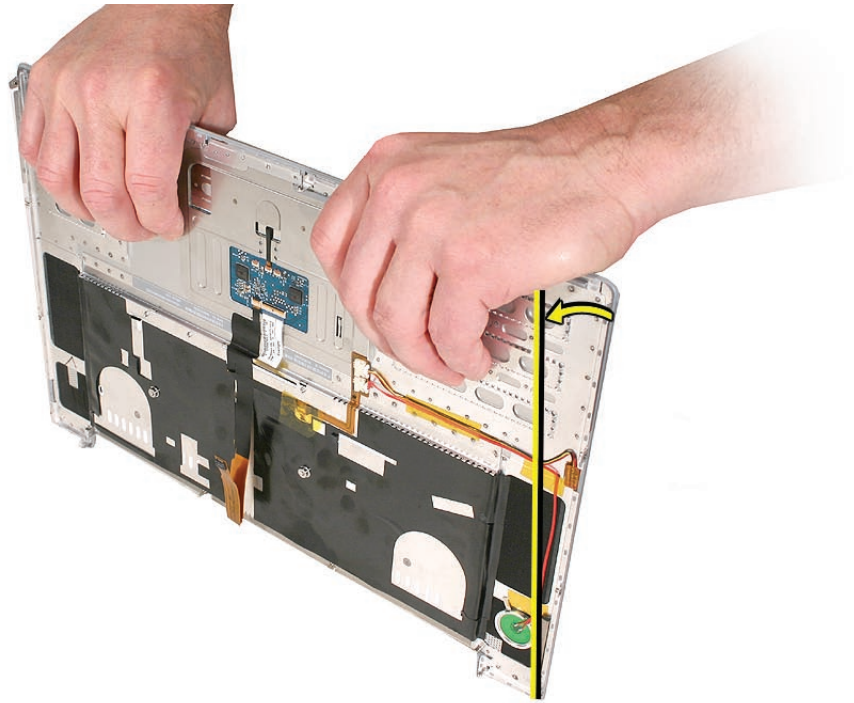

8. Any screw tabs that are not straight will not fit or accept screws correctly.

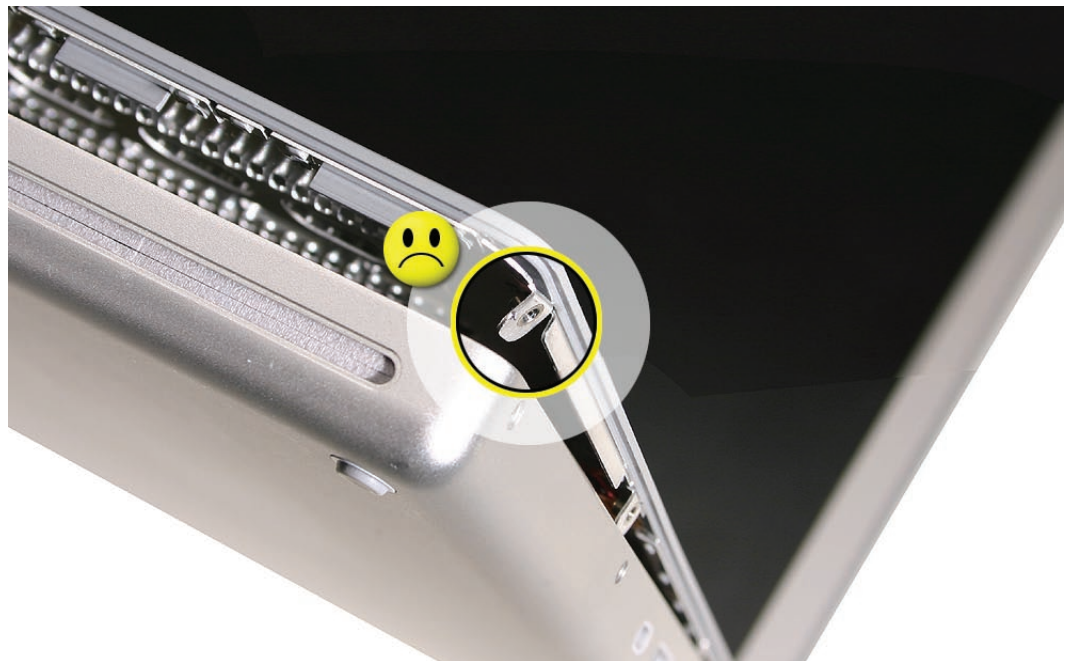

9. Use your finger and a black stick to carefully straighten bent screw tabs.

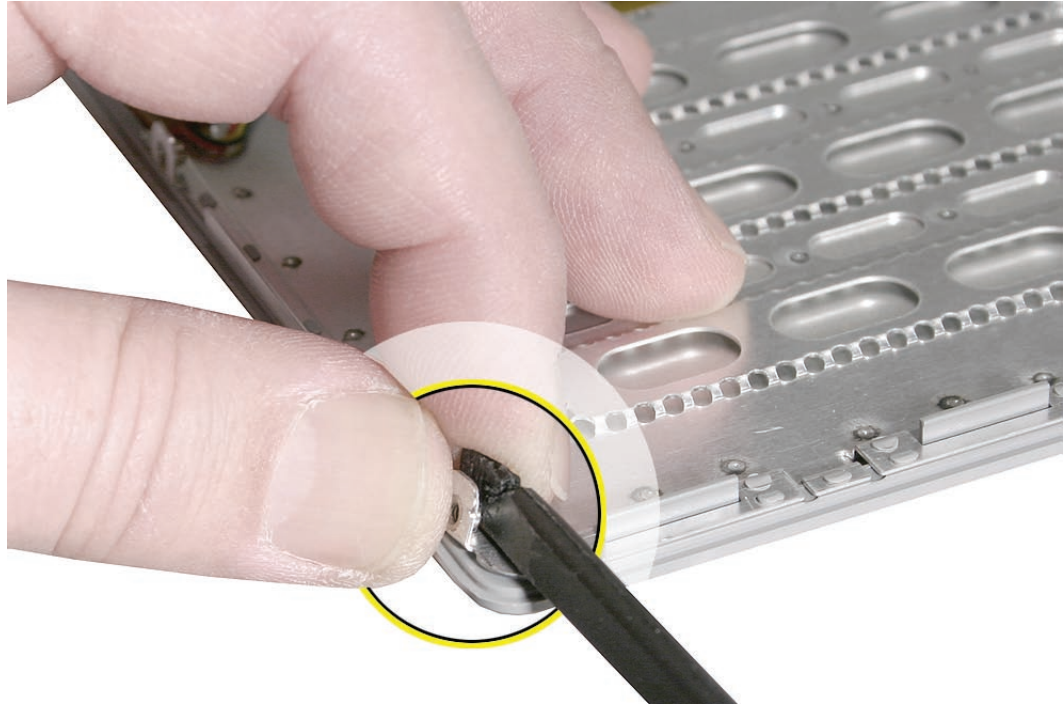

10. Connect the flex cable from the top case to the logic board.
11. Lift the top case off the bottom case slightly and rotate it down (verify that the keyboard cable stays connected and is folding properly) and align the corners.
12. Carefully pull or push tabs slightly, if needed. **Note:** Guarded, controlled pushing with your thumb may be helpful to finesse the tabs into place.
13. The two front screw tabs may need to be guided with a black stick through the battery bay.
14. The top case should lay flat along all sides and top, if not, make sure that cables and components are not interfering.
15. Reinstall the left and right side screws.
Important: Do not insert screws into the DVI port screw holes. If they get stuck, it may require removing the logic board to dislodge.



16. Install the bottom screws.

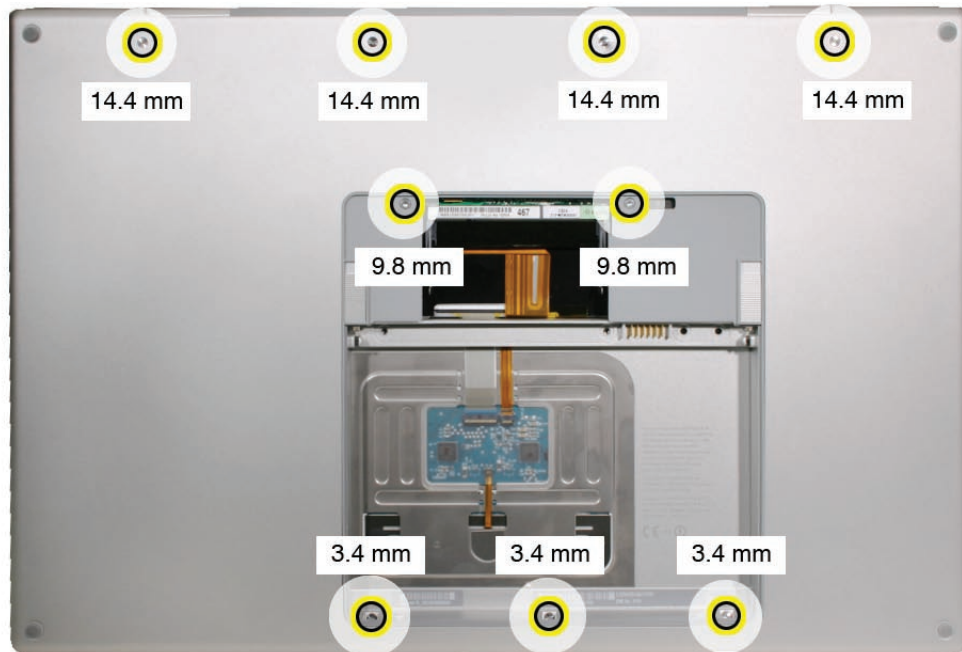

17. Install the two screws along the back.



18. Install the memory door and replace the battery.

19. Testing the computer should include:

- Powering on, checking the keyboard and trackpad function.
- Operate the computer in a darkened room to check for keyboard backlight function.



Keyboard

Tools

This procedure requires the following tools:

- #0 Phillips screwdriver (magnetized)
- Razor knife
- Needlenose pliers
- Black stick (nylon probe 922-5065) or other non-conductive nylon or plastic flat-blade tool
- Kapton tape (922-1731) (0.5-inch x 12-yard roll)

Preliminary Steps

Before you begin, remove the following:

- [Battery](#)
- [Top Case](#)

Part Location



Procedure

Important Notes:

- All 17-inch MacBook Pro keyboards are not interchangeable with previous PowerBook models nor any 15-inch MacBook Pros. Verify that the correct replacement keyboard is ordered, and/or top case if replacing.
 - In addition, keyboards for all models of the 17-inch MacBook Pro are not interchangeable, ie, side tabs were removed on the MacBook Pro 17-inch (2.4GHz & Early 2008), the Caps Lock key was remapped to address a developer issue on the MacBook Pro (17-inch Core 2 Duo), and the function keys were changed on the MacBook Pro (17-inch Early 2008).
 - The keyboard comes as a multi-layered assembly, which includes backlighting. Do not disassemble the keyboard assembly. Dust, fingerprints, or misalignment can cause improper function and damage.
 - Some photo details below may differ slightly from the model of 17-inch MacBook Pro you are repairing; however, unless otherwise specified, the procedure itself remains consistent for any of the models.
 - Where there are differences in procedure between the MacBook Pro 17-inch (2.4GHz & Early 2008) keyboard (with twelve screws and only six tabs) and the previous 17-inch MacBook Pro keyboards (with ten screws but ten tabs), the steps will be differentiated accordingly.
1. On a clean flat surface, turn the top case upside down.
 2. Locate the small flex connector, shown.

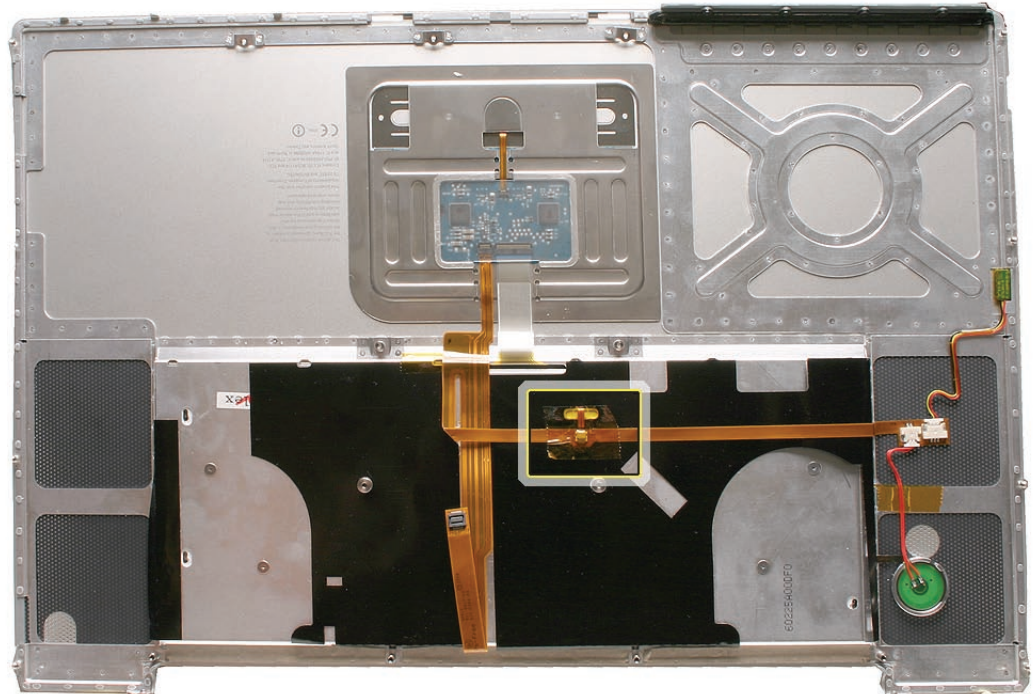

3. Peel off any tape to gain access to the connector.

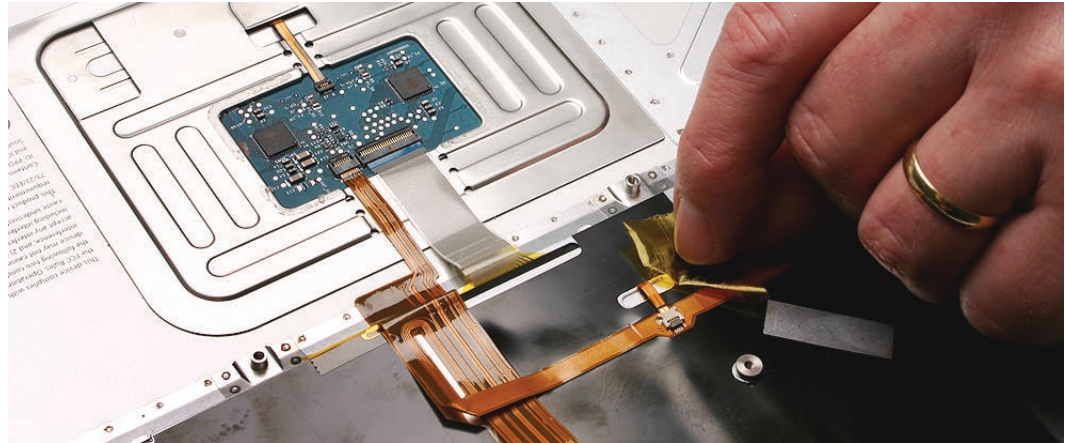

4. Locate the protective cover over flex cable connectors. This will not be removed, but released only half way around to access the large flex cable connector.

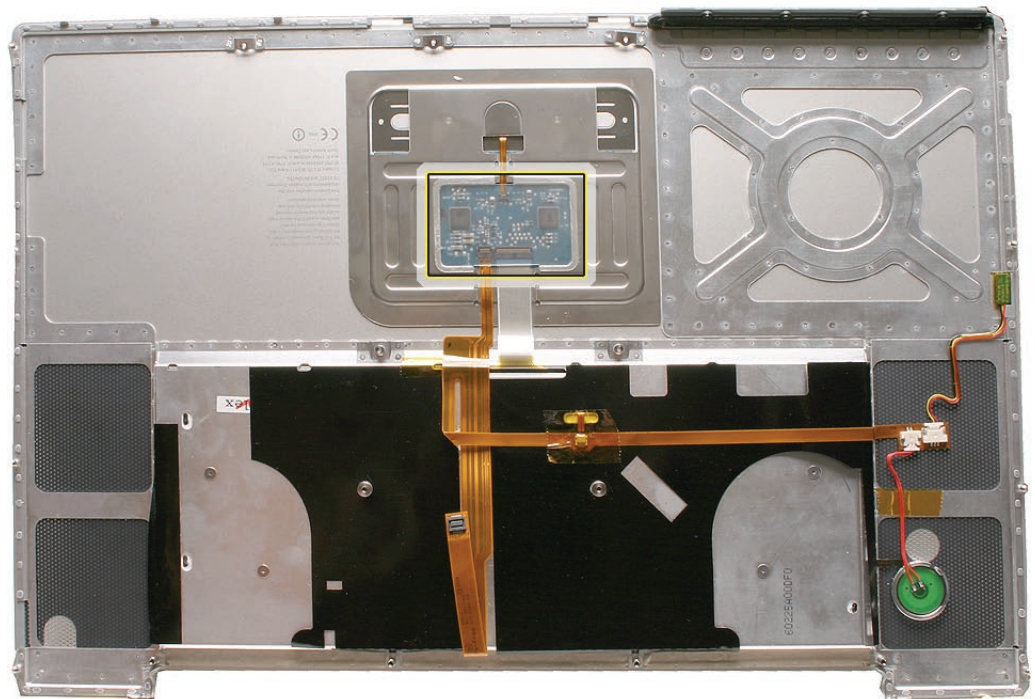

5. Use a razor knife to carefully lift up at the edge just enough to slide in the flat side of a black stick.

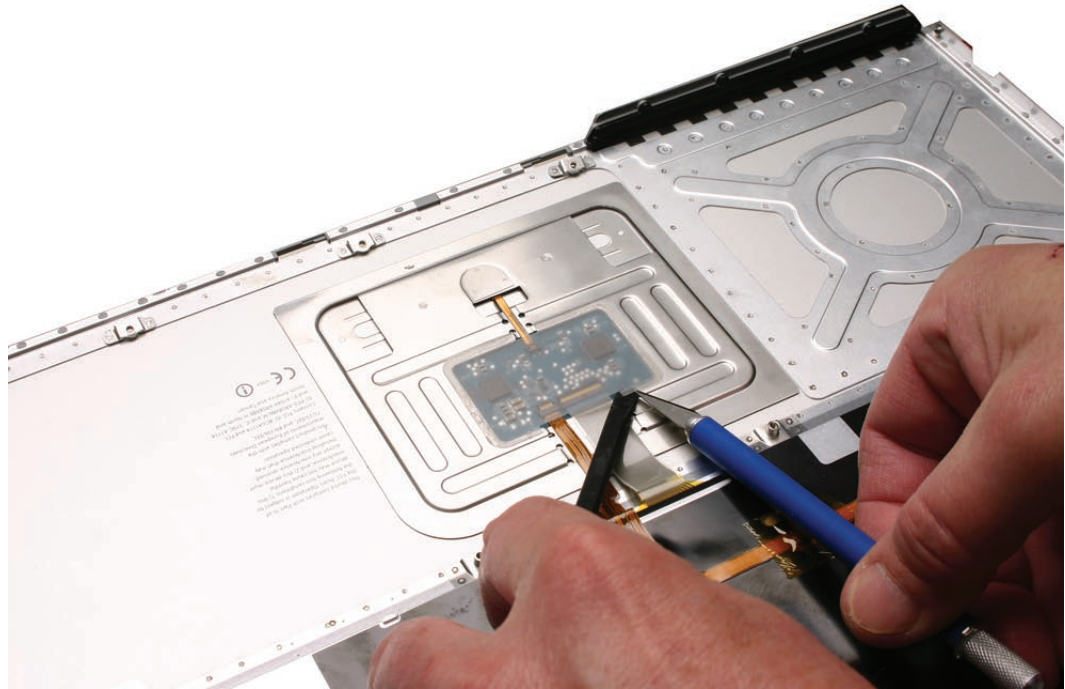

6. To release the adhesive, slide the black stick around the front half perimeter only, as shown.
7. When disconnecting or installing the large flex cable, carefully lift the front of the cover.
Important: Keep the cover and its adhesive clean.

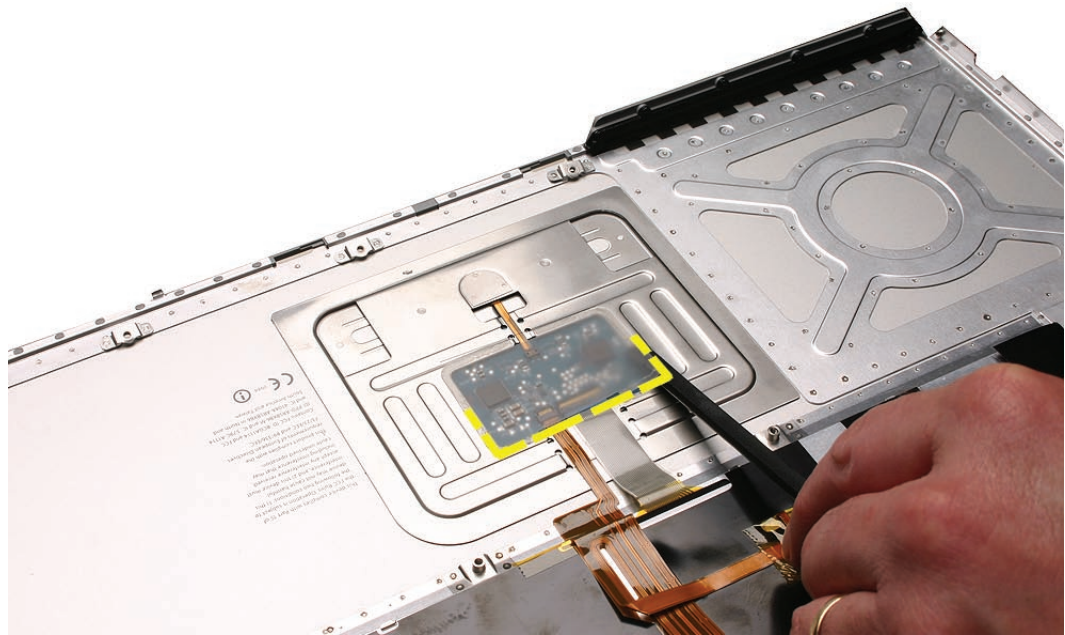

- Carefully disconnect the two connectors, shown below, and slide out their flex cables. The direction that the connector lock bars release is shown in the illustration below. **Important:** The connectors are delicate. If damaged, the top case must be replaced. **Note:** The clear cover is shown removed here, for clarity only.

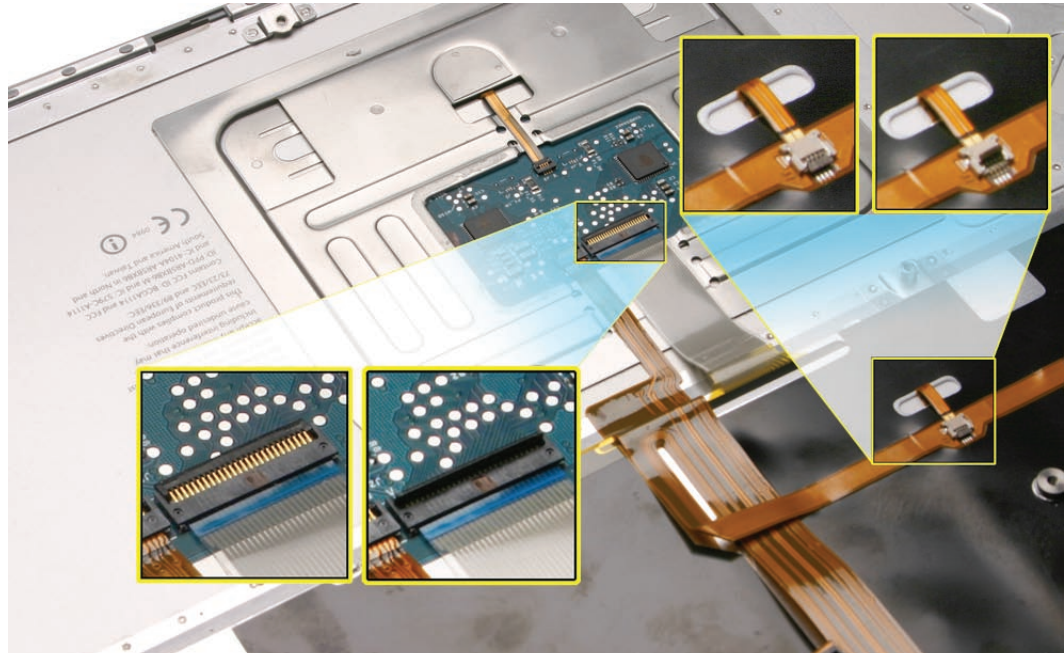

- Release the adhesive under the large flex cable.

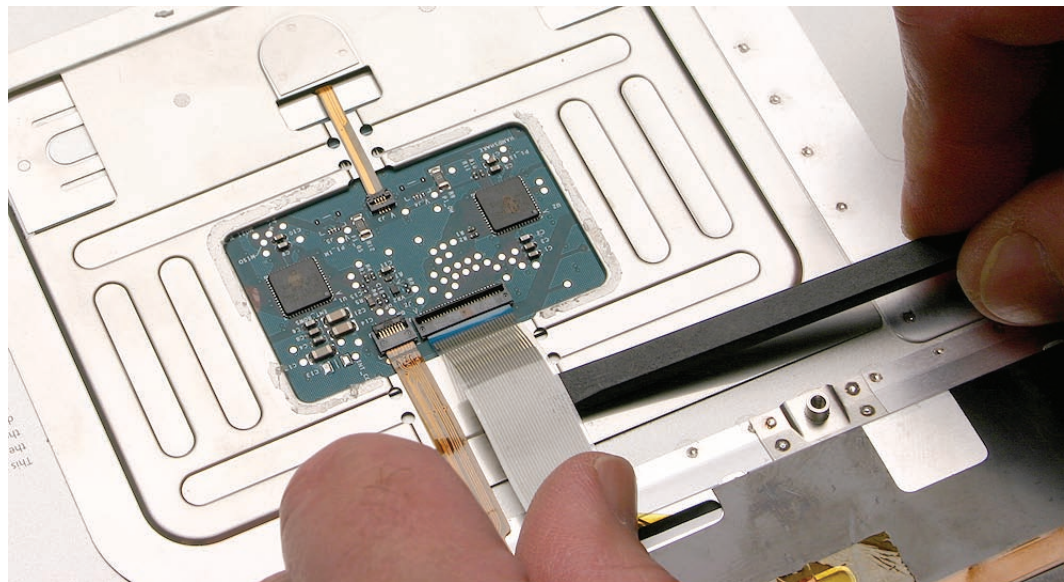

10. Locate the insulator film covering the back of the keyboard well. The film will NOT be removed, but will be peeled back to first access four bend-tabs in the MacBook Pro (17-inch and 17-inch Core 2 Duo) and six bend-tabs in the MacBook Pro (17-inch 2.4GHz and Early 2008) along the bottom edge, and then to access some keyboard screws.

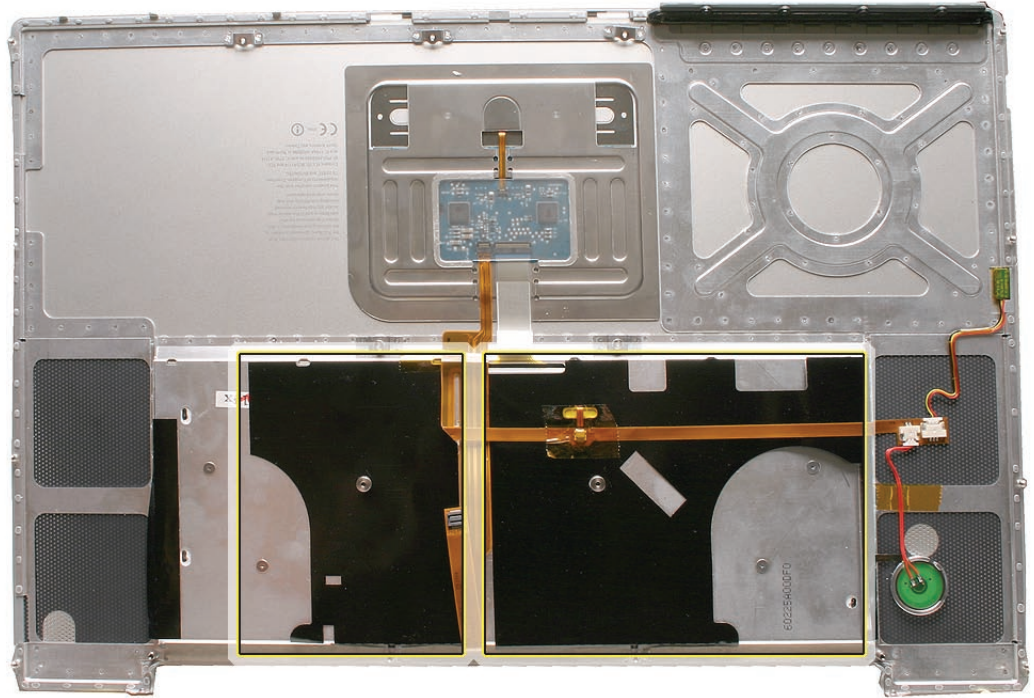

11. Use a razor knife to carefully lift up at the edge just enough to slide in a black stick. **Important:** Do NOT cut the film with the knife.

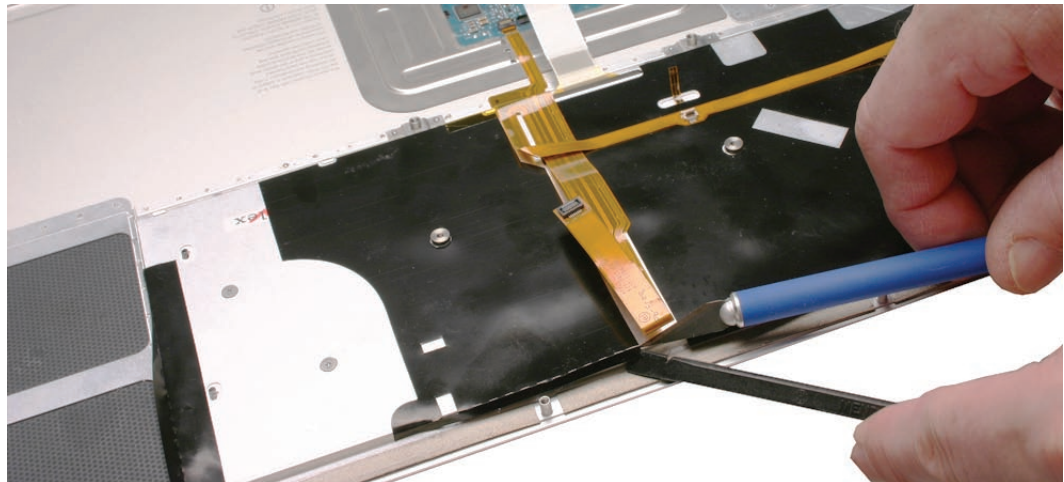

-
12. Use the black stick to defeat the adhesive at the edge so that the film can be peeled back to access the bend tabs.

Important: When peeling, use care at perforations, notches and narrow parts to avoid ripping the film.

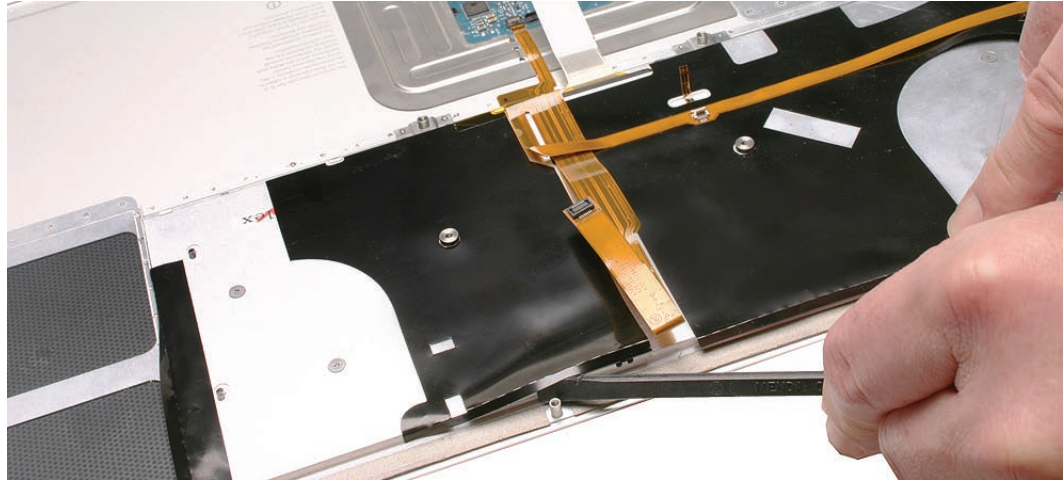

13. Peel back the film to access the bend-tabs. **Note:** Both films are peeled back here to show tab location, but you should work on one side at a time.

Note: There are four bend-tabs in the MacBook Pro (17-inch and 17-inch Core Duo) and six bend-tabs in the MacBook Pro (17-inch 2.4GHz and Early 2008).

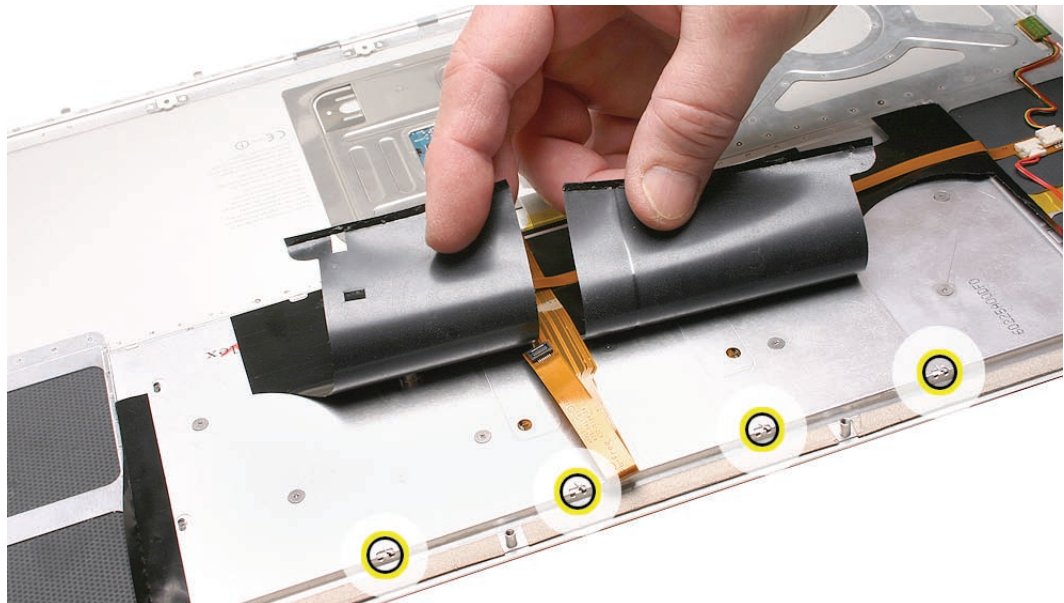

14. Use needlenose pliers to gently and carefully straighten the bend-tabs located along the bottom edge, as shown. These tabs lock down and stiffen the top edge of the keyboard.

Important: The bend-tabs are delicate. Bend with care to avoid damage. Avoid over-bending.

(a) MacBook Pro (17-inch) and MacBook Pro (17-inch Core 2 Duo) have four bend-tabs.

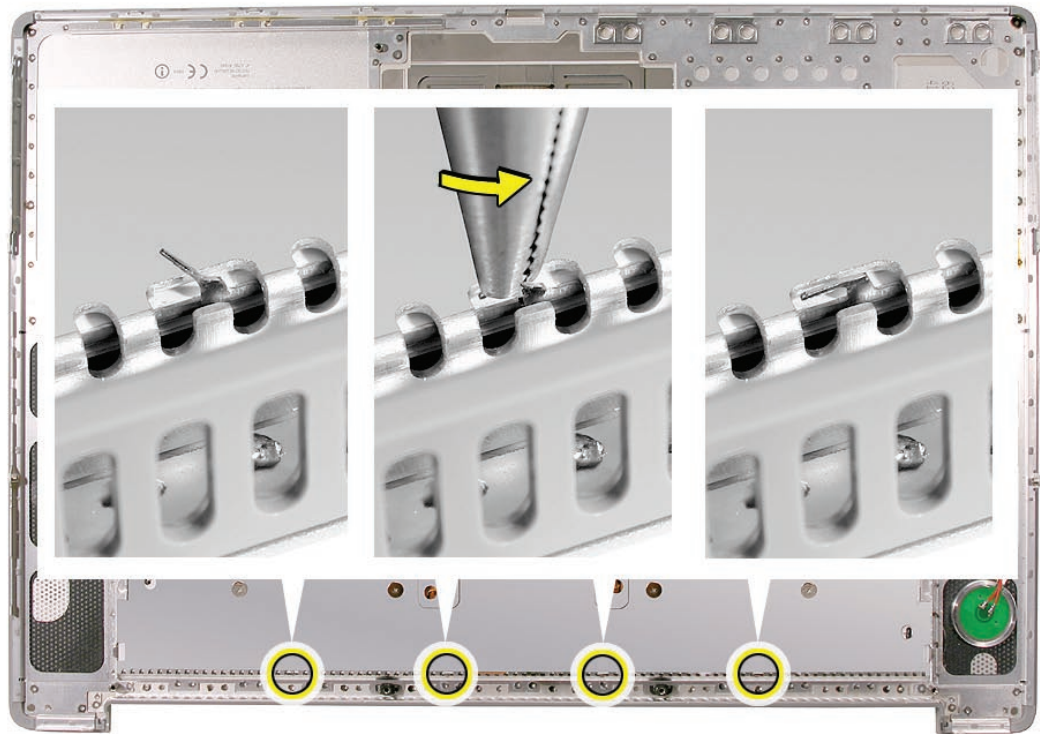

(b) MacBook Pro (17-inch 2.4GHz) and (17-inch Early 2008) have six bend-tabs.

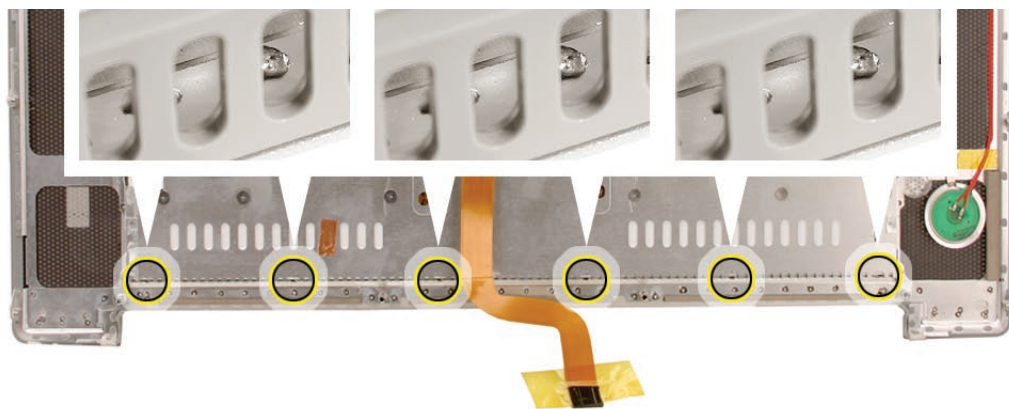

15. Remove the Phillips #00 keyboard screws. Locations shown below. Be sure to sandwich keyboard to top case when removing the final screws.

(a) MacBook Pro (17-inch) and MacBook Pro (17-inch Core 2 Duo) each have ten screws.

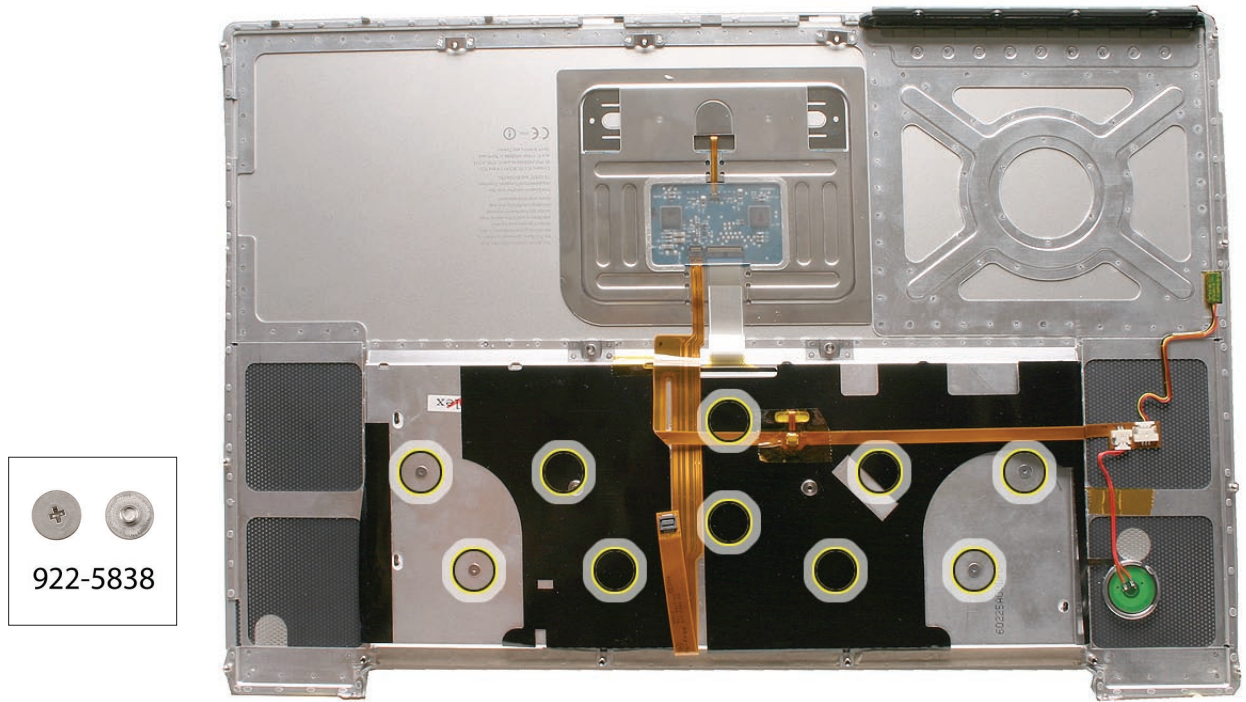

(b) MacBook Pro (17-inch 2.4GHz) and (17-inch Early 2008) have twelve screws (one extra screw on each side).

Note: Photo below is for screw location identification only. Proceed with the procedure with the Mylar film still in place as above.

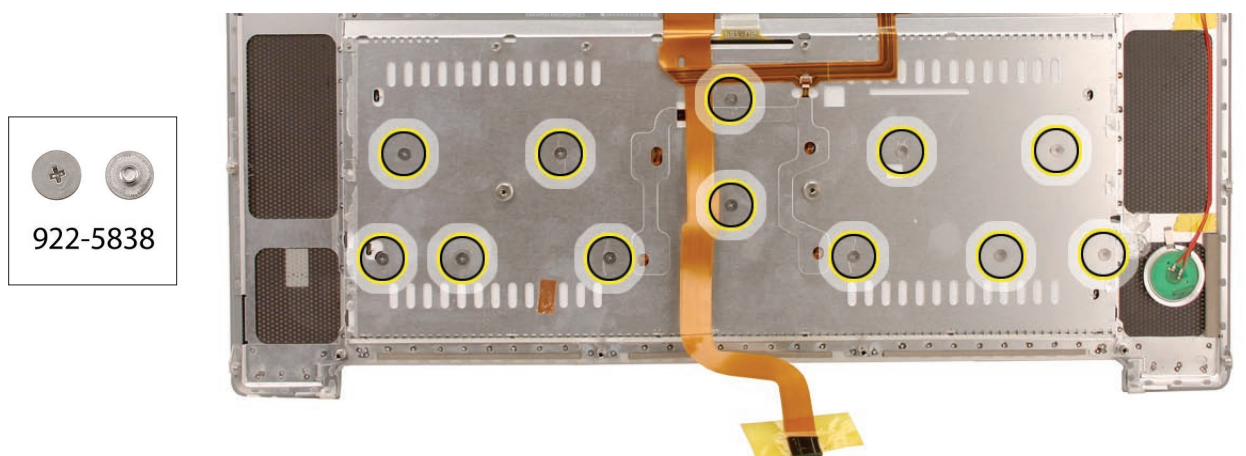

-
16. Carefully peel back the film as needed to access the screws.

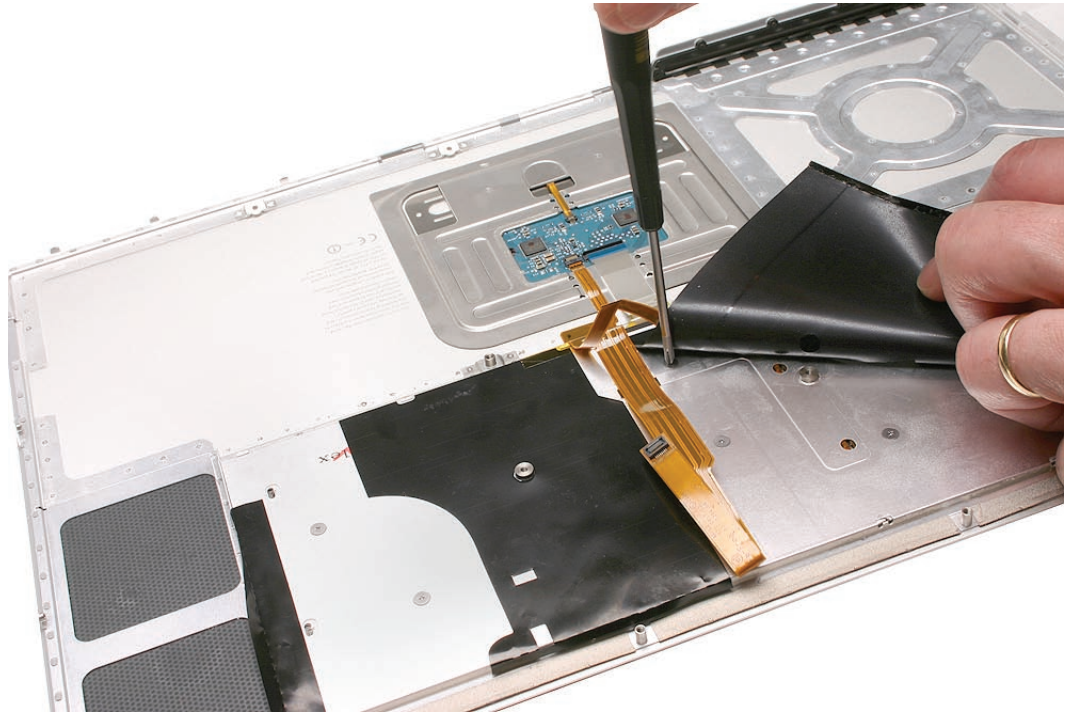

17. To prevent the keyboard from falling out, support it with your hand, and raise the top case up vertically. **Note:** Since the MacBook Pro 17-inch (2.4GHz & Early 2008) keyboards have no side tabs like previous models, the keyboard will more easily fall out of the keyboard well.



18. Note the six insert-tabs along the bottom edge of the keyboard that tuck into the lower edge of the keyboard well of the MacBook Pro (17-inch 2.4GHz) and (17-inch Early 2008).

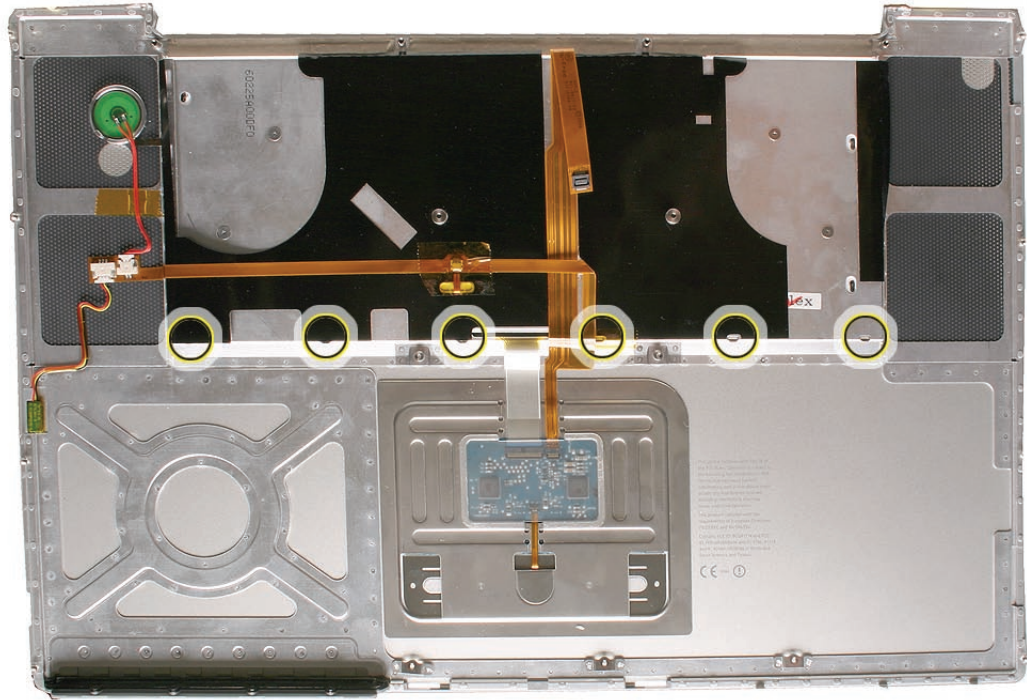

Note: The MacBook Pro (17-inch) and MacBook Pro (17-inch Core 2 Duo) have 2 more sets of tabs on the sides which hold the keyboard in place, making keyboard extraction more complex. For instructions on keyboard removal for these models, skip forward to step 21.)

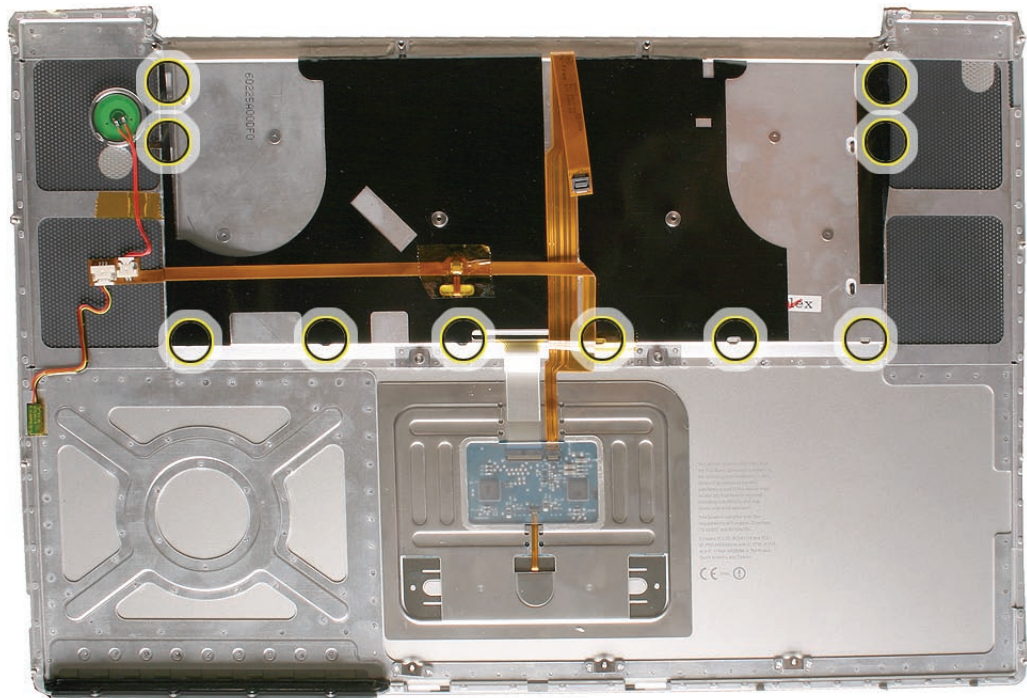

-
19. The MacBook Pro 17-inch (2.4GHz and Early 2008) keyboard may simply fall free of the top case if you lean it toward you top first.

Note: For instructions on keyboard removal for the MacBook Pro (17-inch original) and MacBook Pro (17-inch Core 2 Duo), skip forward to step 21.)



20. Lift the MacBook Pro (17-inch 2.4GHz and Early 2008) keyboard up and away from the top case to release the tabs along the bottom edge and carefully thread out the flex cables.

Important: During this procedure, do not allow the tabs or metal edge of the keyboard to scrape along the cosmetic surface of the top case; otherwise damage can result.



-
21. The MacBook Pro (17-inch original) and MacBook Pro (17-inch Core 2 Duo) have six insert-tabs along the edge of the keyboard well PLUS two more sets of tabs on each side. The following steps show how to release these tabs so that the keyboard can be removed.

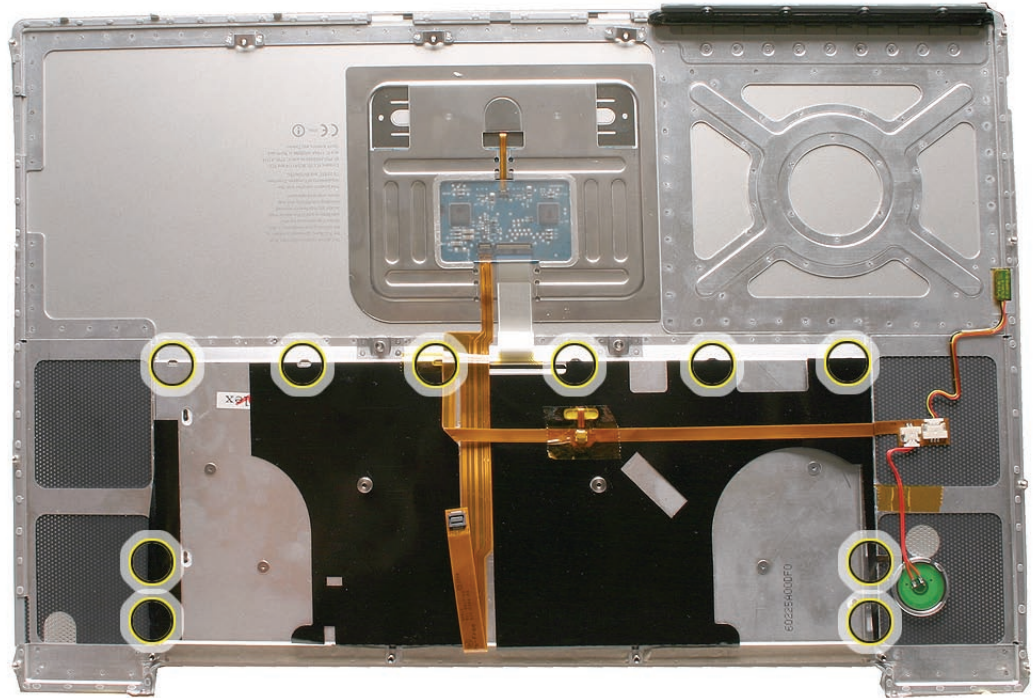

22. If needed, push through one of the top center keyboard screw holes, with the point of a black stick, to bow out the keyboard slightly.

Important: Ensure that the hole used is a screw hole, or damage to other sensitive components may result. A black stick is used to avoid damaging the screw boss threads—do not use a metal tool.

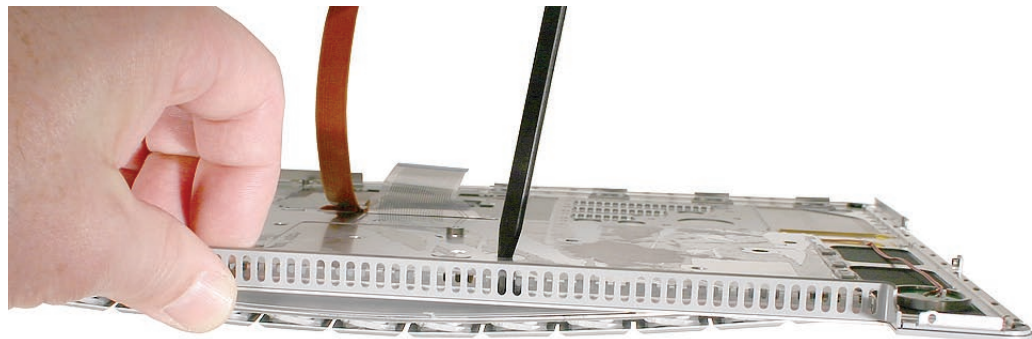



24. Lift the keyboard up to release the tabs along the bottom edge and carefully thread out the flex cables.

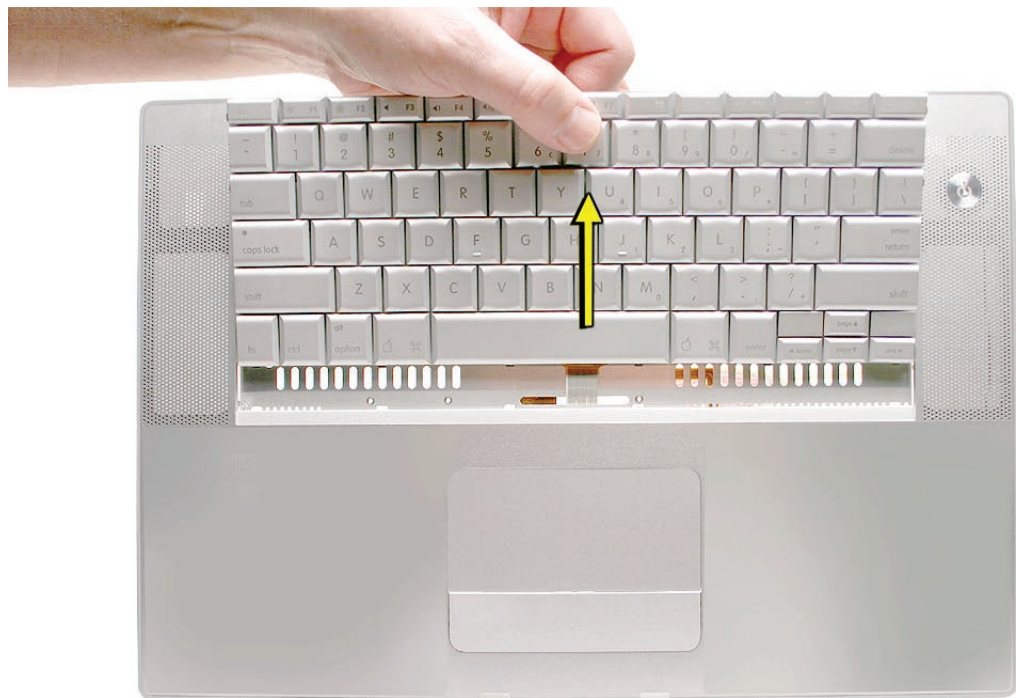

Replacement Procedure

When replacing the keyboard, here are some key points to keep in mind:

- Prevention of scratches to the cosmetics of the top case
 - All tabs are properly seated
 - Keyboard lays flat
 - Bend-tabs are not damaged
 - Screw holes align
 - Cables are not caught
 - Cable connectors are not damaged and cables are secure
 - Kapton tape is applied as before
 - Insulator film is correctly installed
1. Before replacing or installing a replacement keyboard, verify that the bend-tabs along the bottom edge of the keyboard are straight and parallel with the bottom edge (two are shown close-up, below).

Important: Do not bend any other bend-tabs on the keyboard other than the four along the bottom. Other tabs hold the keyboard assembly together.



2. Guide the keyboard's flex cable through the slot in the top case, as shown. Make sure that it does not catch or bend behind the keyboard.

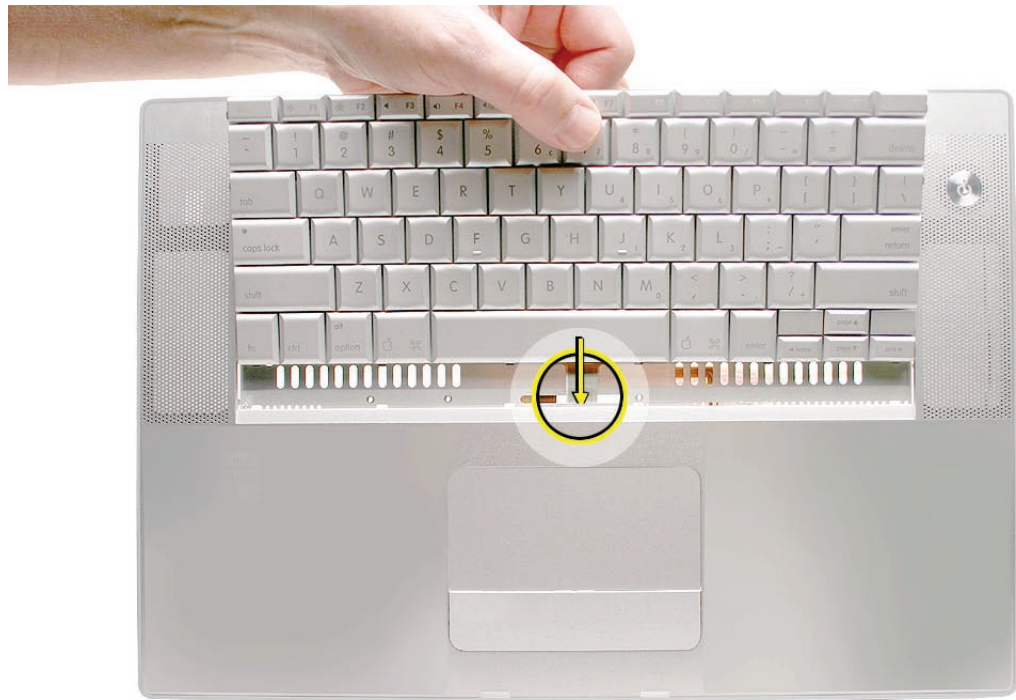

3. Verify that the small cable routes through the small slot, as shown.

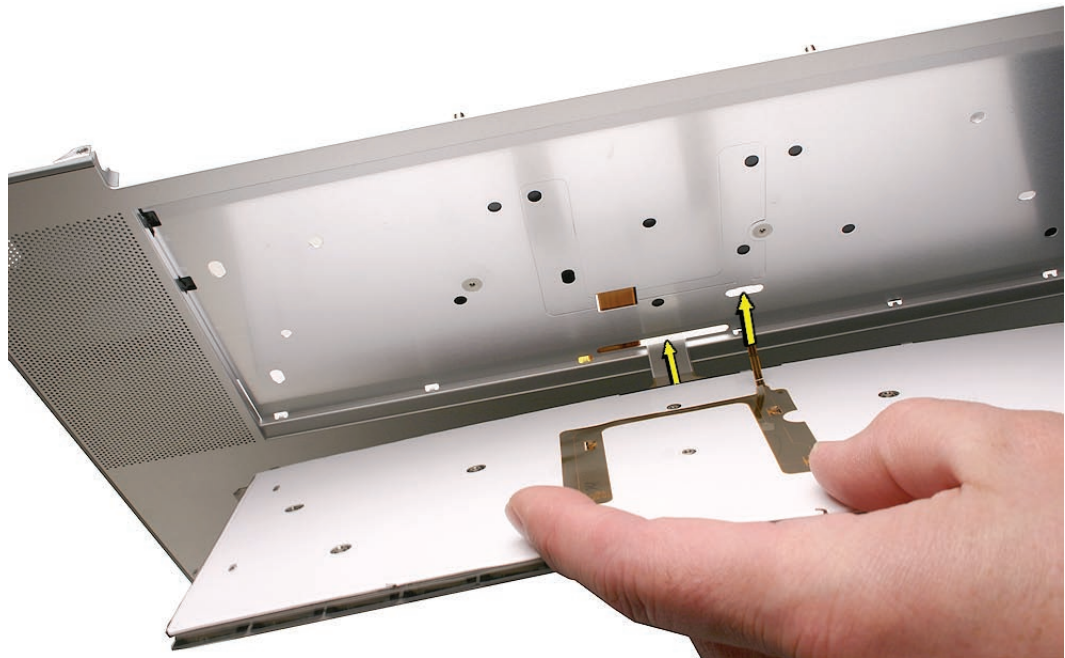

Lower the keyboard and seat all six tabs along the bottom, so that the keyboard sits flat and straight.



Note: The next several steps do not apply to the MacBook Pro (17-inch 2.4GHz or Early 2008) keyboards since they do not have side tabs.

Important: During the next steps, do not allow the tabs or metal edge of the keyboard to scrape along the cosmetic surface of the top case, or damage can result.

4. While ensuring that the keyboard bottom stays straight and secure, hold the top of the keyboard in the middle, then with your other hand, bow in one side of the keyboard to engage the two tabs at the top into the top case.

Important: Do not bow the keyboard too much, or it may become permanently bent.



-
5. Use the heel of your hand to hold in place the edge of the keyboard that was just inserted while holding the top of the keyboard with a finger on that hand, then use your other hand to help bow in the remaining side of the keyboard until it can be engaged.



6. While supporting the keyboard in the top case, verify that the keyboard lays flat and that all the tabs have seated properly.

Note: The keyboard will not lay flat if any of the tabs have not seated correctly. If the side tabs are not seating or are binding, check the bottom edge of the keyboard to verify that all the tabs are seated and the bottom of the keyboard is straight.

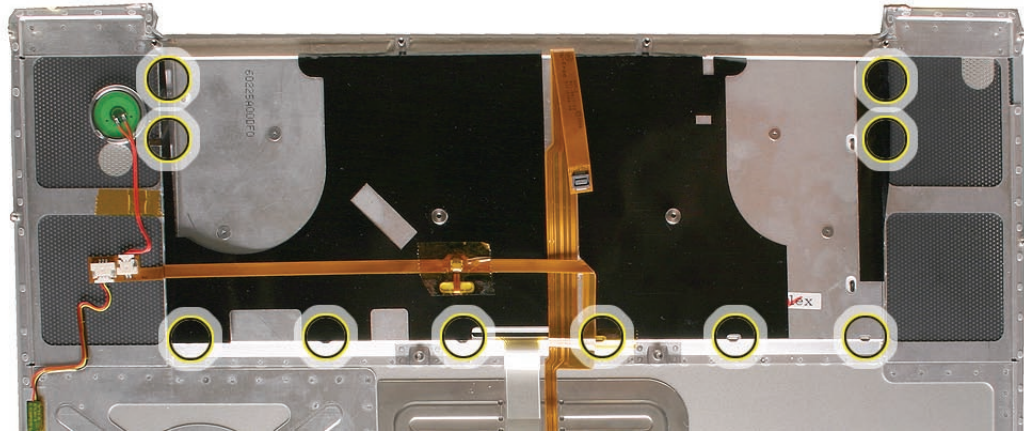

7. On the underside of the top case, peel back the film that covers the two tabs along each side. These tabs must be fully seated, as shown below, for the keyboard to seat properly. Carefully press on the opposing keyboard keys to help these seat, if needed.

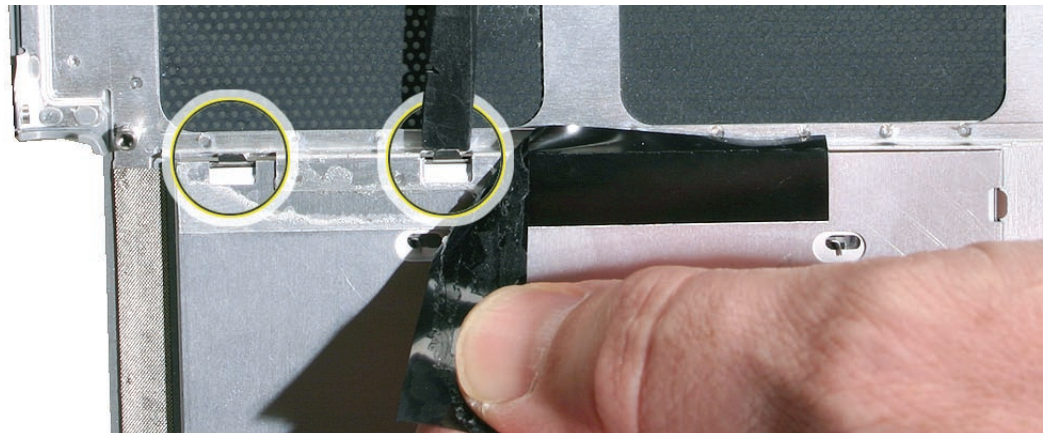

8. Verify that the bend-tabs are not caught.
9. Lay the top case upside down.
10. Pull on the flex cables to verify that they are not bent or caught under the keyboard, and that they extend to their connectors.
11. Verify that the screw holes align with the screw bosses.
12. Install all ten keyboard screws for the MacBook Pro (17-inch original and Core 2 Duo), and twelve screws for the MacBook Pro (17-inch 2.4GHz and Early 2008), starting from the middle and working outward.

13. Bend the four bend-tabs for the MacBook Pro (17-inch original) and (17-inch Core 2 Duo) or the six bend-tabs for the the MacBook Pro (17-inch 2.4GHz) and (17-inch Early 2008) over the metal of the bottom case to secure the bottom edge of the keyboard. Push up on the opposing part of the keyboard to raise it, as needed.

Important: The bend-tabs are delicate. Bend them carefully to avoid damage and no more than 90-degrees, or to, or within, any etch marks, if present. Avoid over bending.

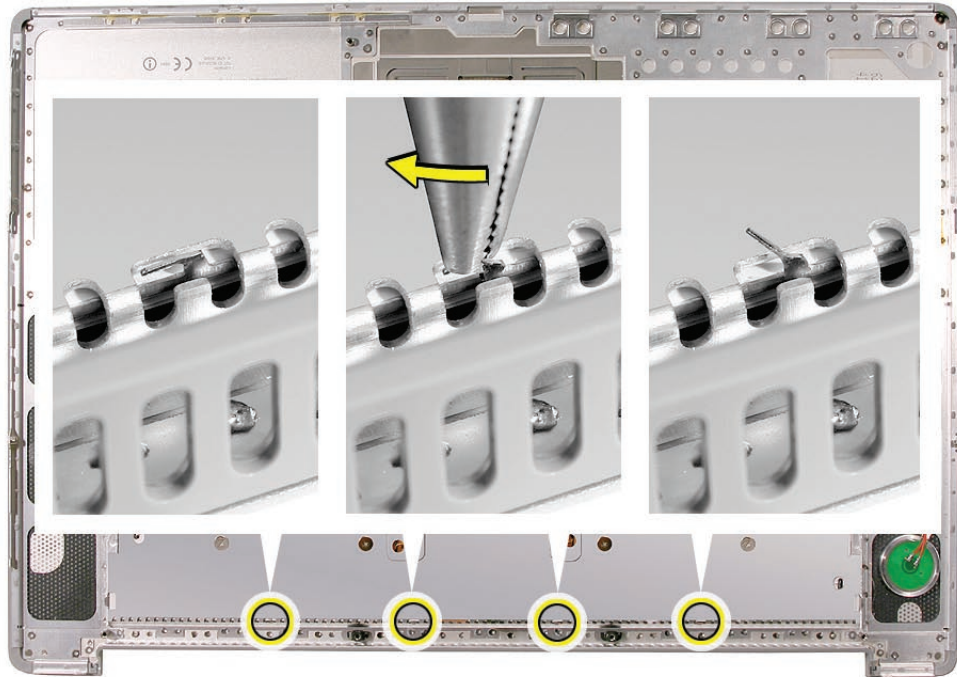

14. To install the small flex, use the pointed end of a black stick to support its middle, then with your finger, guide the loose end back and into the open connector. Secure the locking tab.

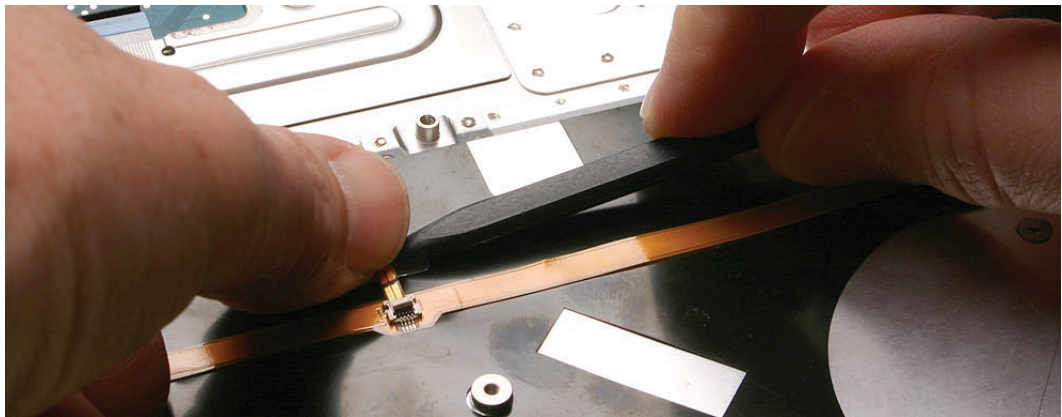
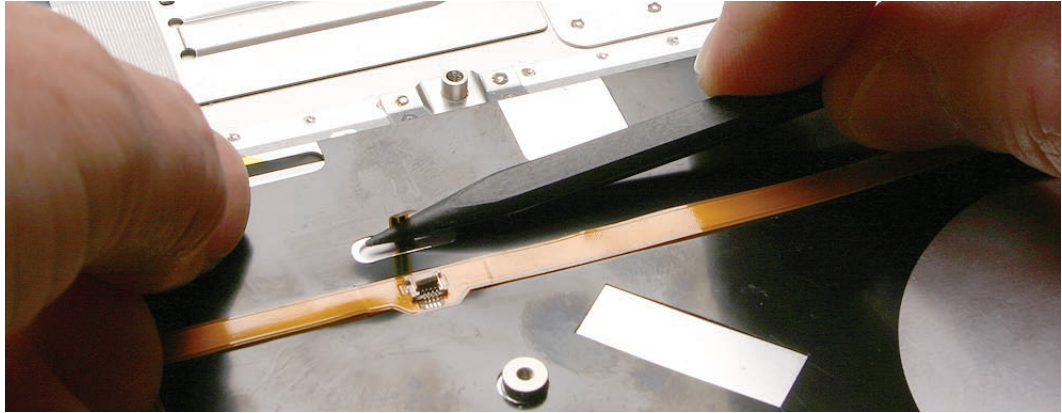

15. Install Kapton tape over the flex and connector as shown.

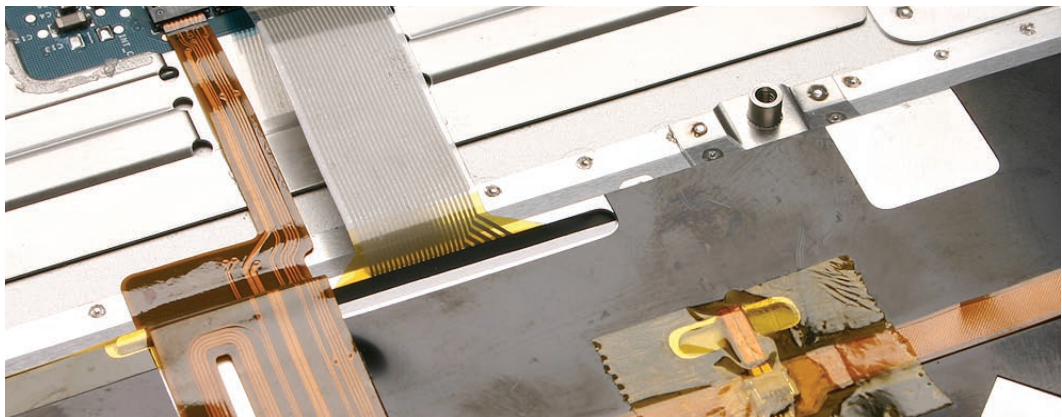

16. If installing a replacement keyboard, peel the adhesive protector off of the back of the large flex cable.
17. Support the cable with a black stick to prevent it from sticking to the top case and insert it straight and fully into the open connector. Secure the locking tab.

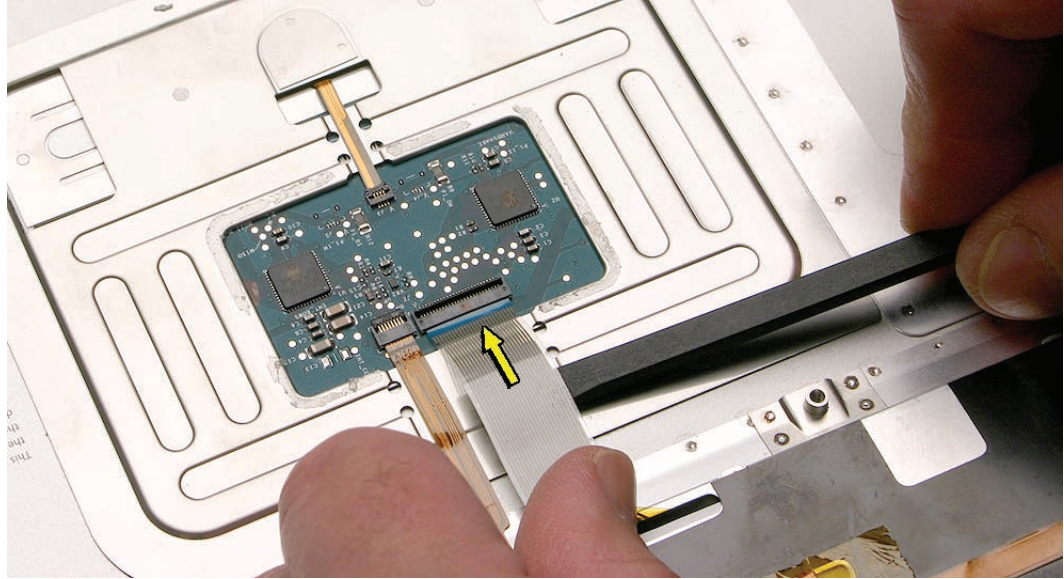

18. Press the cable flat to secure its adhesive.

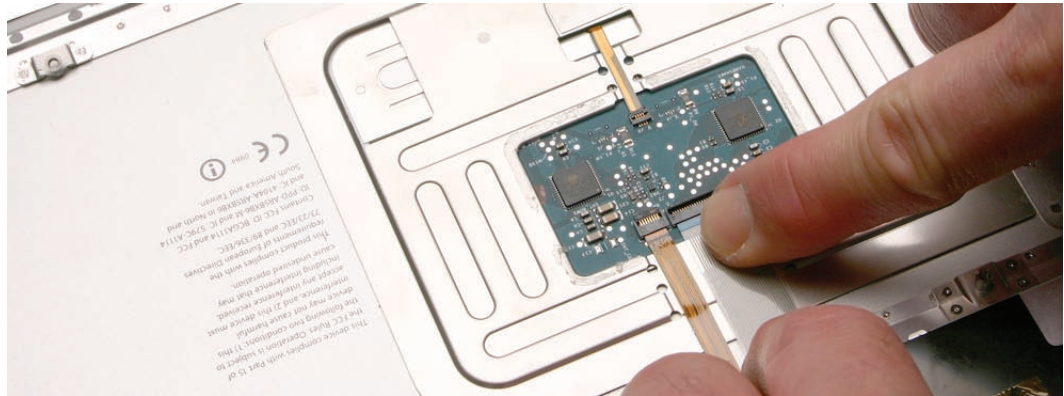

19. With a black stick, burnish down the edges of the protective cover that were lifted.

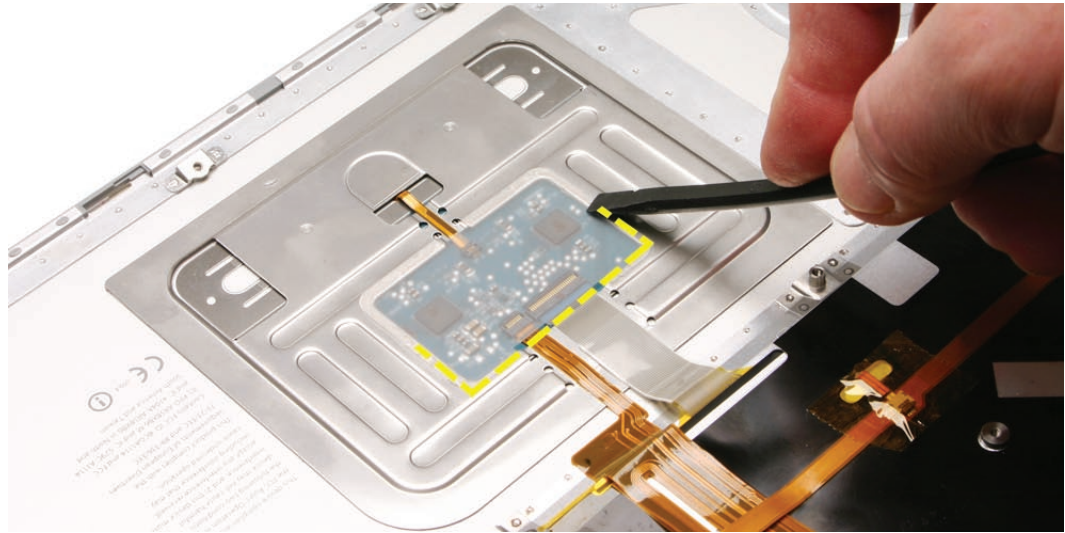

20. Run your finger along the film, where shown, to secure it over the edges.

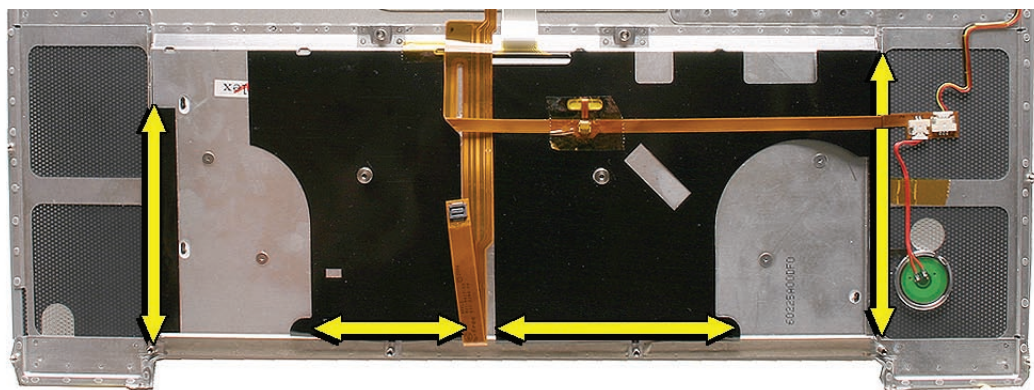

21. Reassemble the computer.

Quick Test

- Testing the computer should include checking the keyboard and trackpad function.
- Operate the computer in a darkened room to check for keyboard backlight function, and light leakage around the perimeter of the keyboard, speaker grill openings and side ports.



AirPort Extreme Card

Tools

This procedure requires the following tools:

- Torx T6 screwdriver (magnetized)
- Black stick (nylon probe 922-5065) or other non-conductive nylon or plastic flat-blade tool

Preliminary Steps

Before you begin, remove the following:

- [Battery](#)
- [Top Case](#)

Part Location

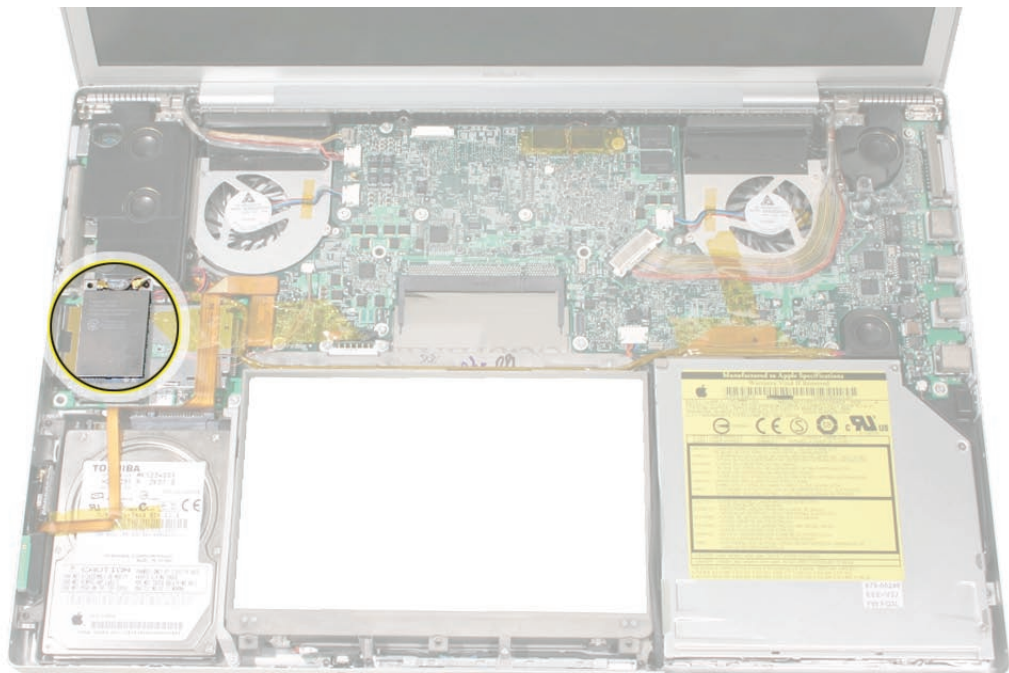

Procedure

1. (a) MacBook Pro 17-inch (original and Early 2008) models: Remove two antenna connectors. Lift straight up.

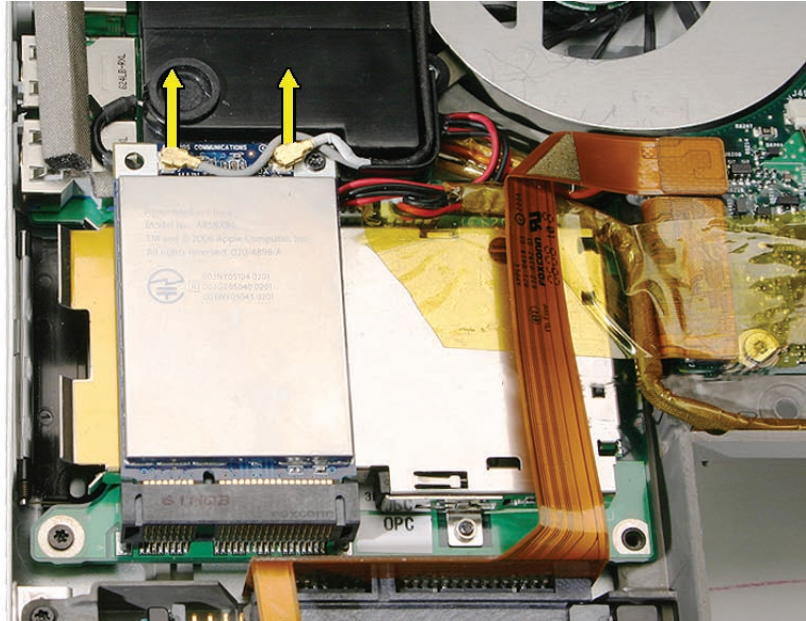

2. (b) MacBook Pro 17-inch (Core 2 Duo and 2.4GHz) models: Remove three antenna connectors. Lift straight up.

Note: The Airport cards in the 17-inch (Core 2 Duo, 2.4GHz and Early 2008) have an EMI clip attached to the left of the card. Transfer this clip to the replacement card, if need be.

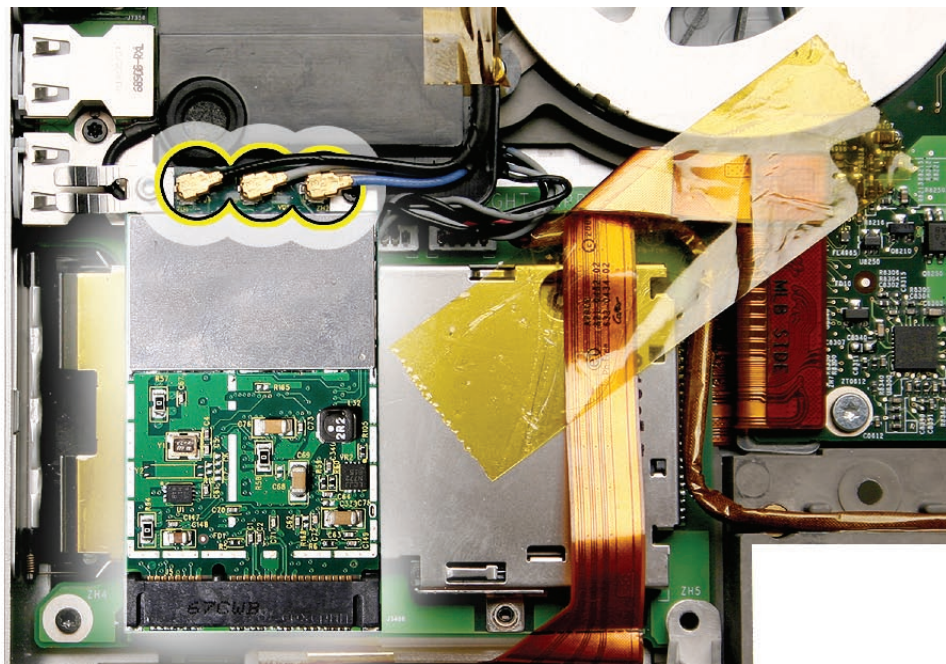

Note: Some photo details below may differ slightly from the model of 17-inch MacBook Pro you are repairing; however, the procedure itself remains consistent for any of the models.

3. Remove the one screw. The card should rise up slightly.

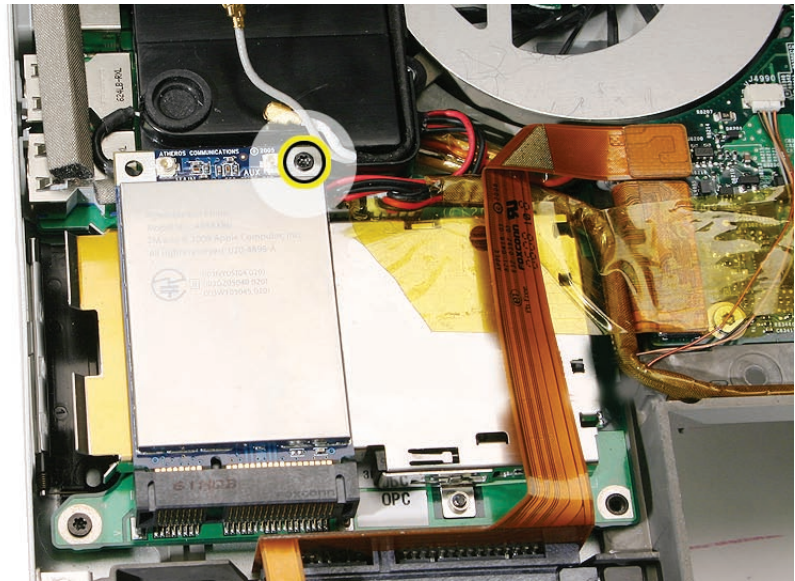

4. Pull the card straight out.



5. **Replacement Notes:**

- Verify that the antenna cables lay flat within the channel along the edge of the speaker.

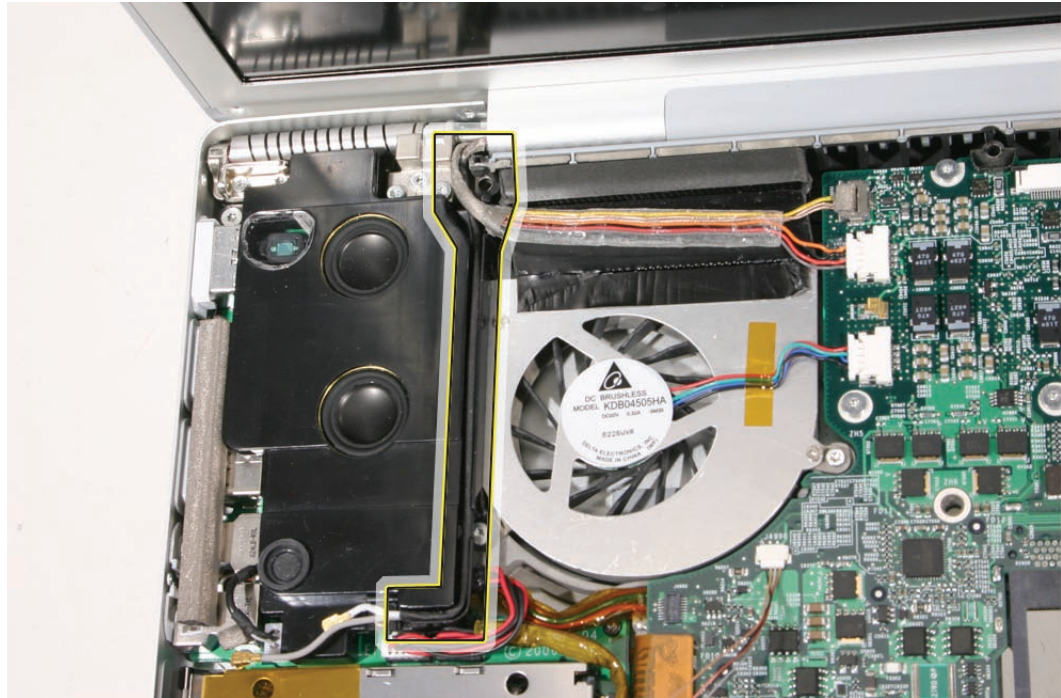

- If not, use Kapton tape to secure, as shown.

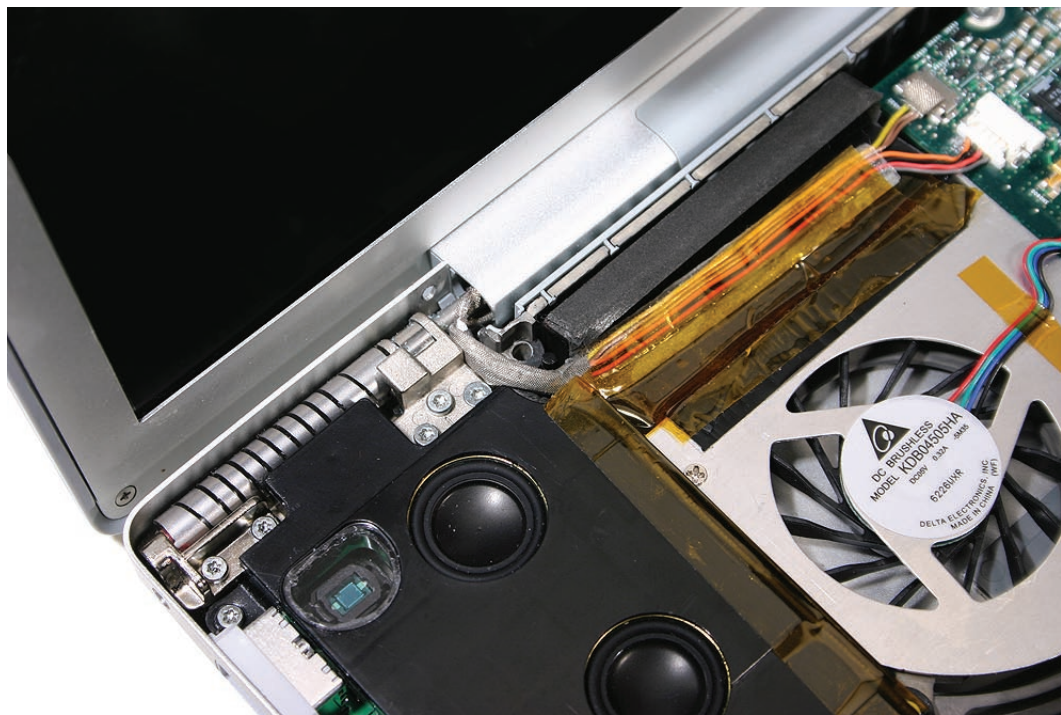

- Also verify that the cables for the antennas, camera and inverter route to the left of the pin and screw hole at the top right corner of the speaker.

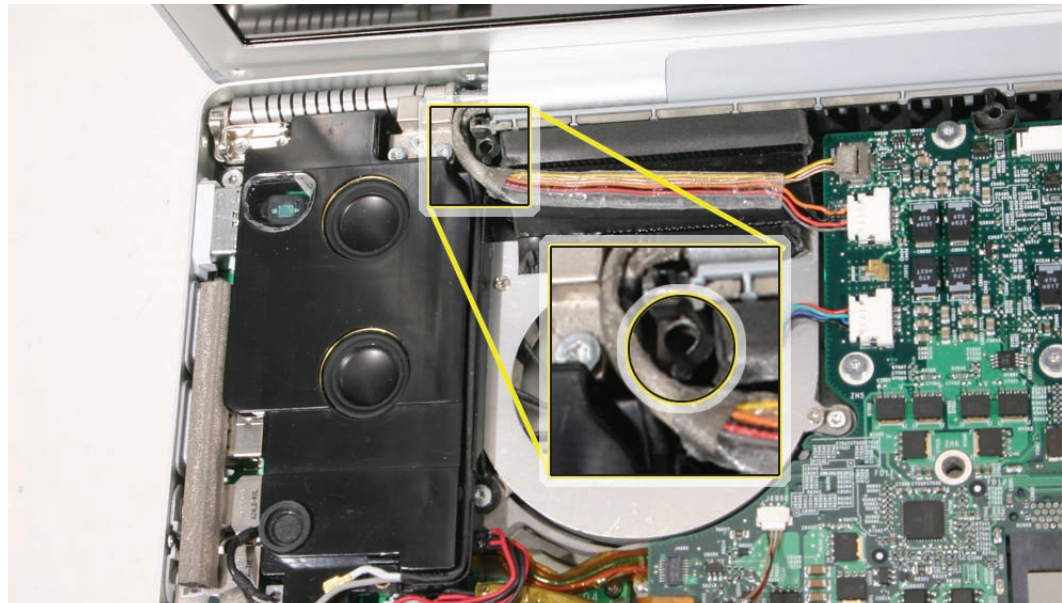

6. Reassemble the computer.
7. Testing should include AirPort function.

Quick Test: Open up Apple System Profiler to make sure the Airport Extreme card is recognized under the AirPort Card tab in the Network section.



Hard Drive

Tools

This procedure requires the following tools:

- Torx T6 screwdriver (magnetized)
- Black stick (nylon probe 922-5065) or other non-conductive nylon or plastic flat-blade tool
- Kapton tape (922-1731) (0.5-inch x 12-yard roll)

Preliminary Steps

Before you begin, remove the following:

- [Battery](#)
- [Top Case](#)

Part Location

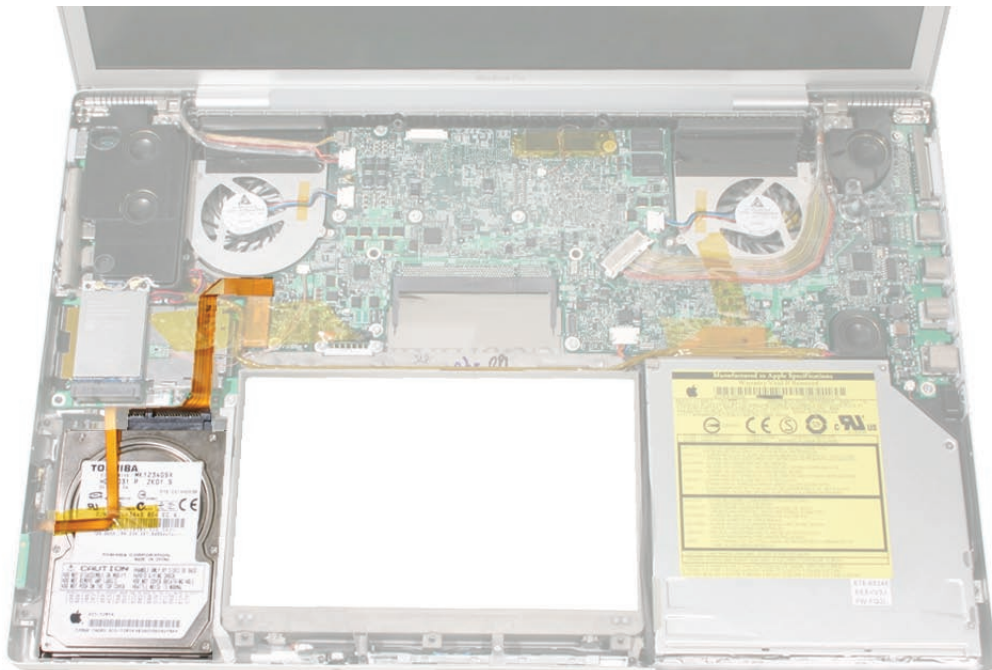

Procedure

Note: Some photo details below may differ slightly from the model of 17-inch MacBook Pro you are repairing; however, the procedure itself remains consistent for any of the models.

1. Disconnect the hard drive/bluetooth flex cable connector from the logic board.
2. Remove the two screws securing the hard drive holder.

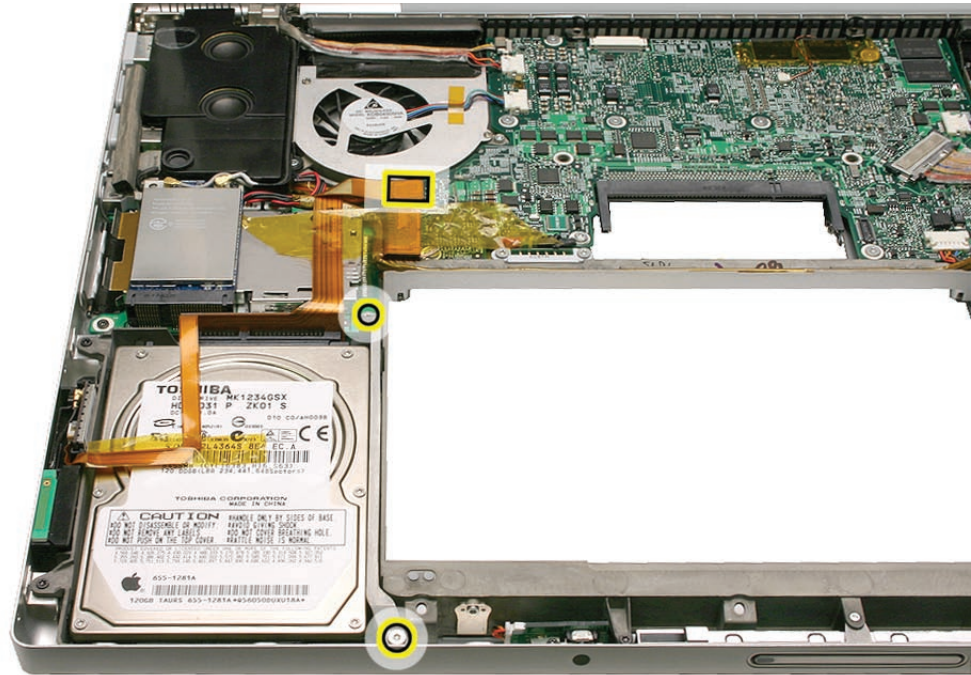

3. Lift out the holder.



7. Kapton tape may wrap all the way around the flex connector to the back side of the hard drive. If so, hold the hard drive by its sides to turn it over and release the Kapton tape.

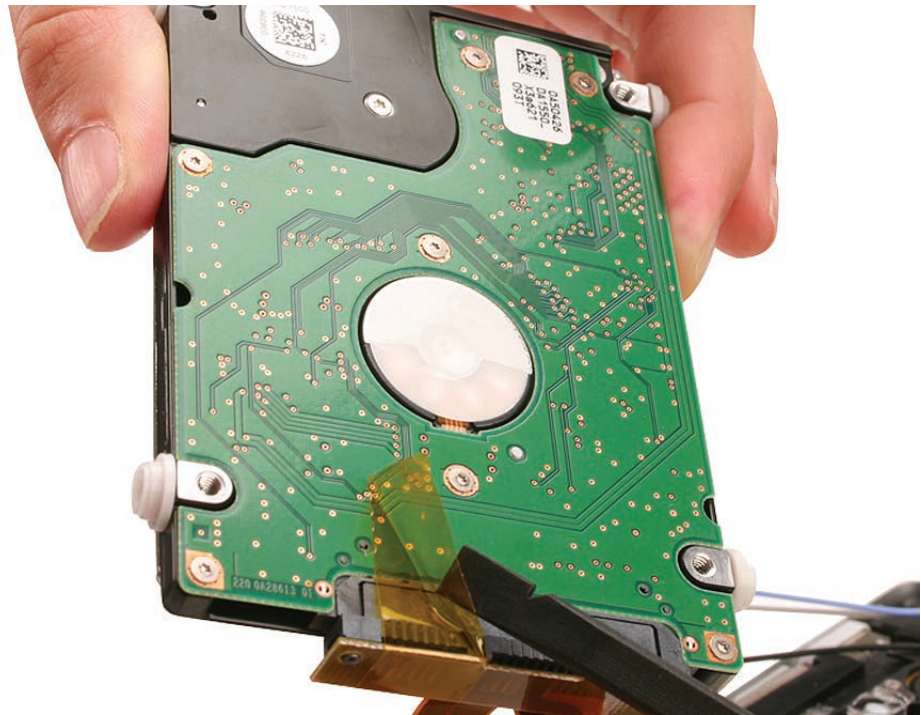

8. Disconnect the hard drive flex connector by pulling it straight back away from the hard drive.

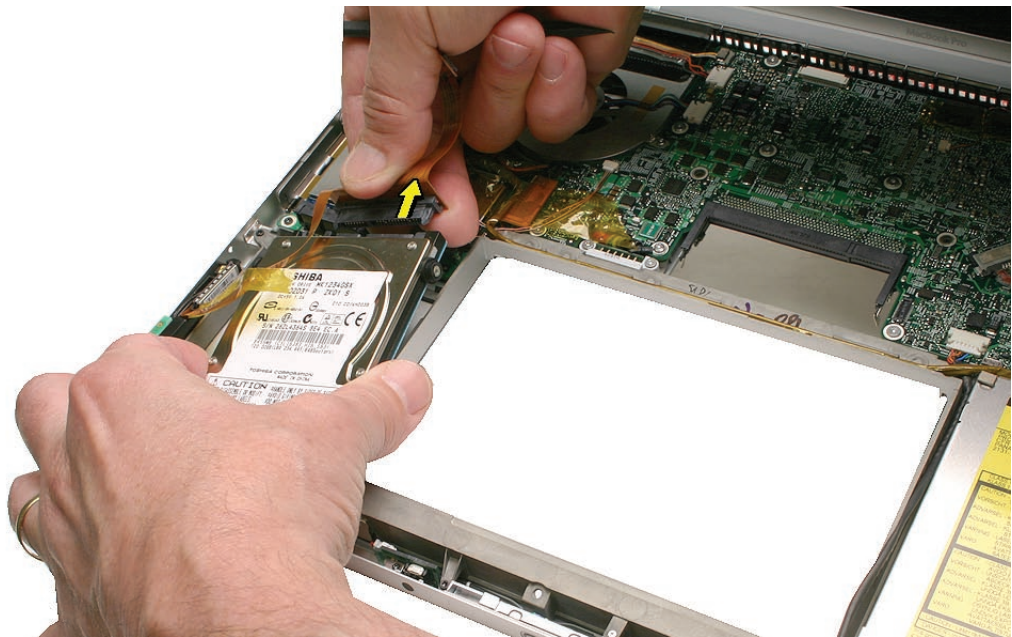

- Transfer the hard drive screws and two grommets on the right side to the replacement drive.

Important Note: All older MacBook Pro 17-inch models should have any white hard drive grommets replaced by newer black grommets (same part number: 922-7941).



- Verify that the two rubber grommets are installed on the bottom case frame
- Replacement Note:** When installing the hard drive, verify that the two screw heads installed on its left side, fit securely into the two grommets on the frame.

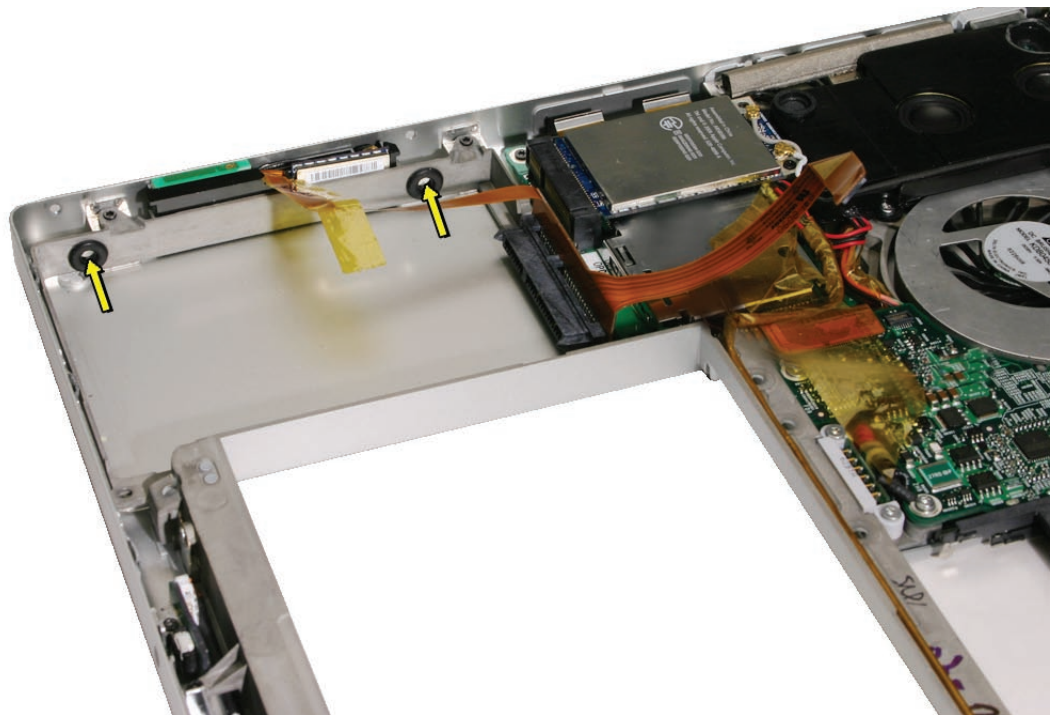



Bluetooth Card and Antenna

Tools

This procedure requires the following tools:

- Black stick (nylon probe 922-5065) or other non-conductive nylon or plastic flat-blade tool
- Kapton tape (922-1731) (0.5-inch x 12-yard roll)

Preliminary Steps

Before you begin, remove the following:

- [Battery](#)
- [Top Case](#)

Part Location

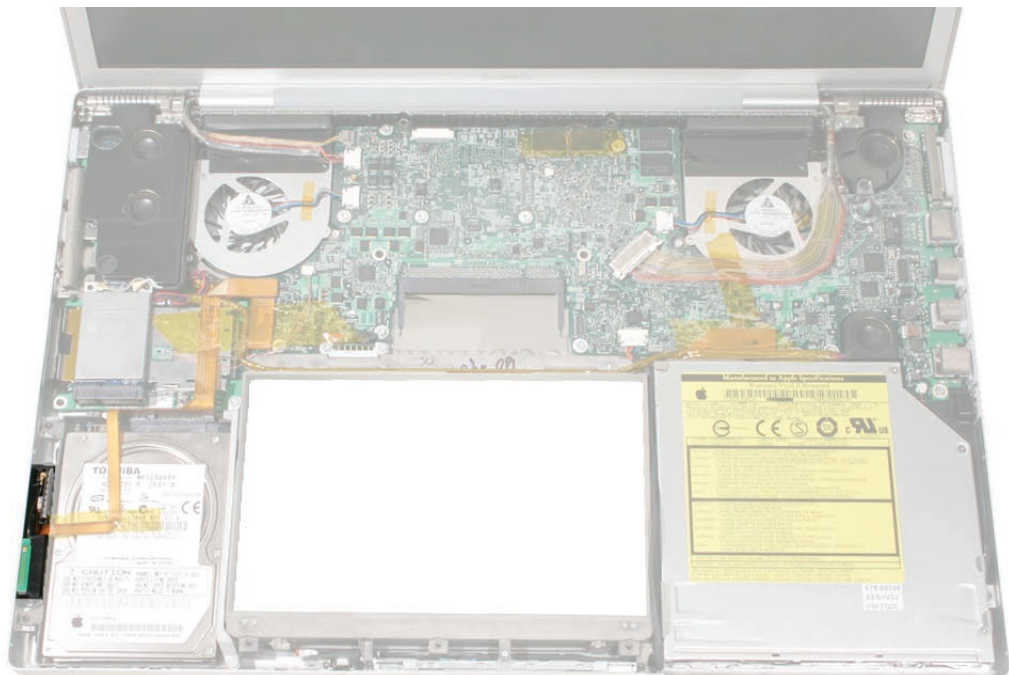

Procedure

The bluetooth assembly includes the bluetooth card and antenna installed onto a bracket.

1. Lift the bluetooth bracket assembly out of its channel.



2. If the bracket is wrapped in EMI foil, carefully remove the foil below as shown in the following series of illustrations.

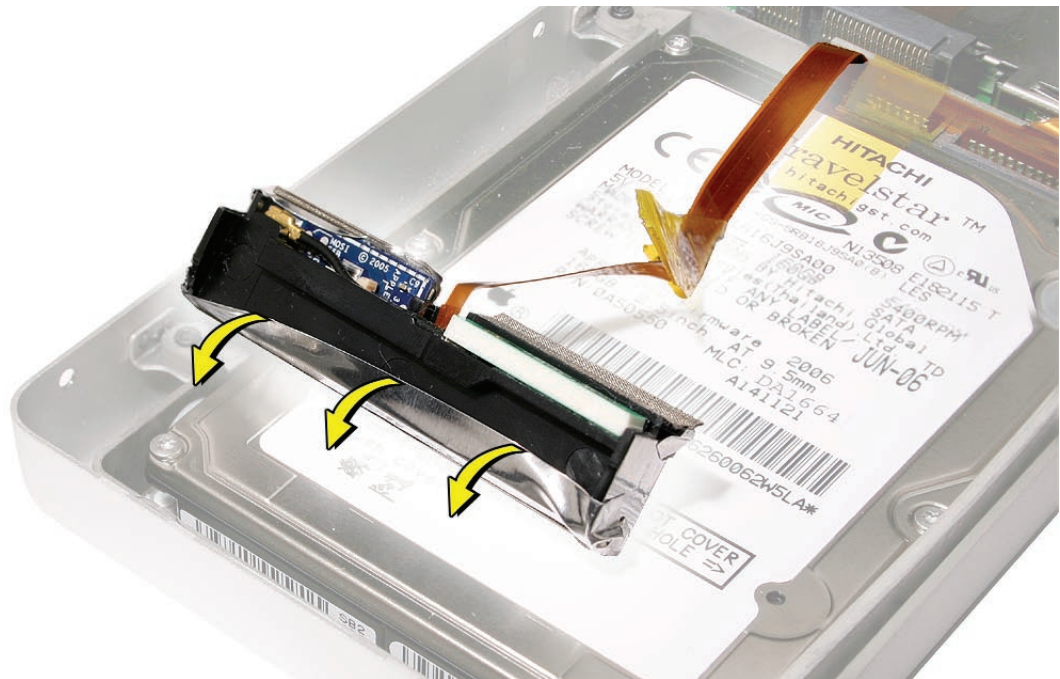

3. (a) Carefully and slowly peel the foil from the bottom first, (b) then down the back side of the bracket, and (c) then the top last. If it remains intact enough for reuse, set aside the foil for reinstallation. Otherwise, the EMI shield is available to order as a separate part (922-7969).

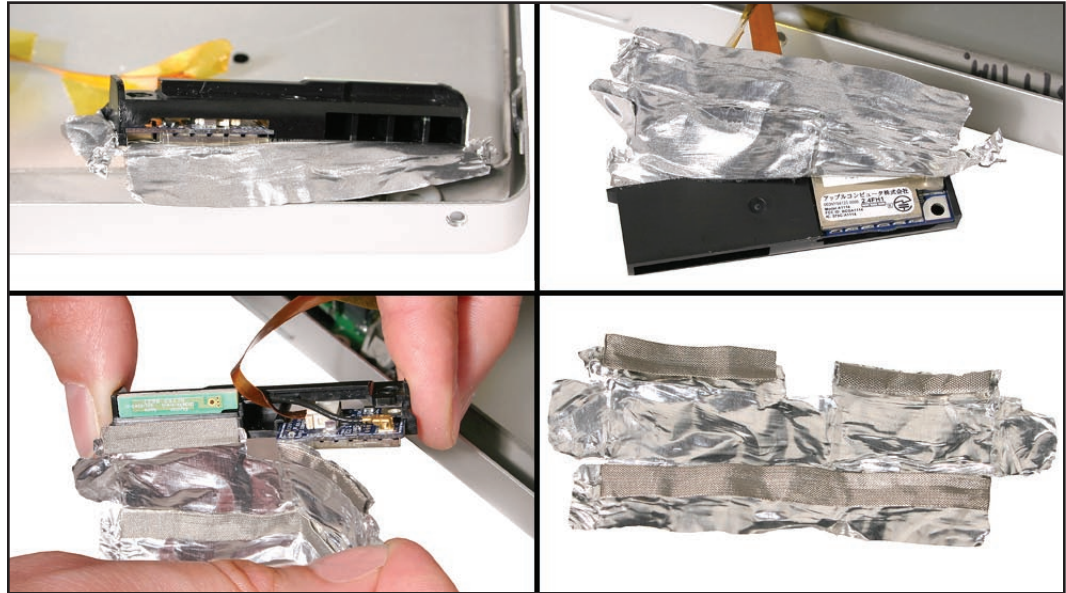

4. Slide the bluetooth card out of the bracket.

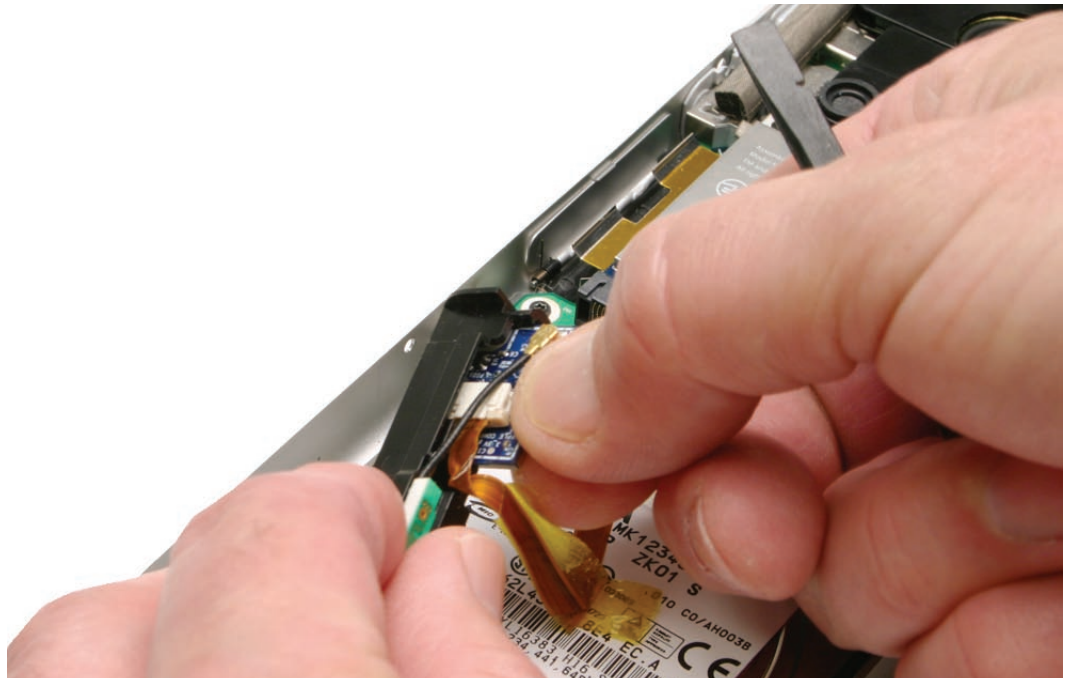

5. Lift the antenna cable connector straight off to disconnect.



6. If replacing the bluetooth card, disconnect the flex cable by releasing the sliding lock.

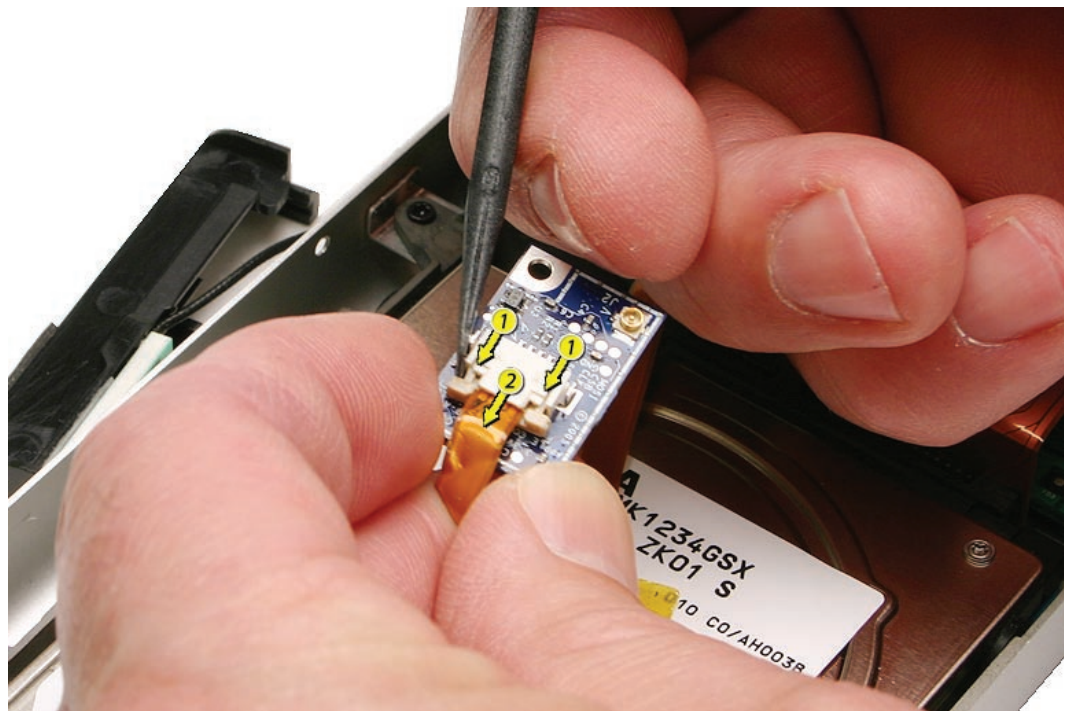

-
7. To replace the antenna, pry the antenna board off the plastic bracket. Make sure that the adhesive strip stays on the bracket, and keep it clean.

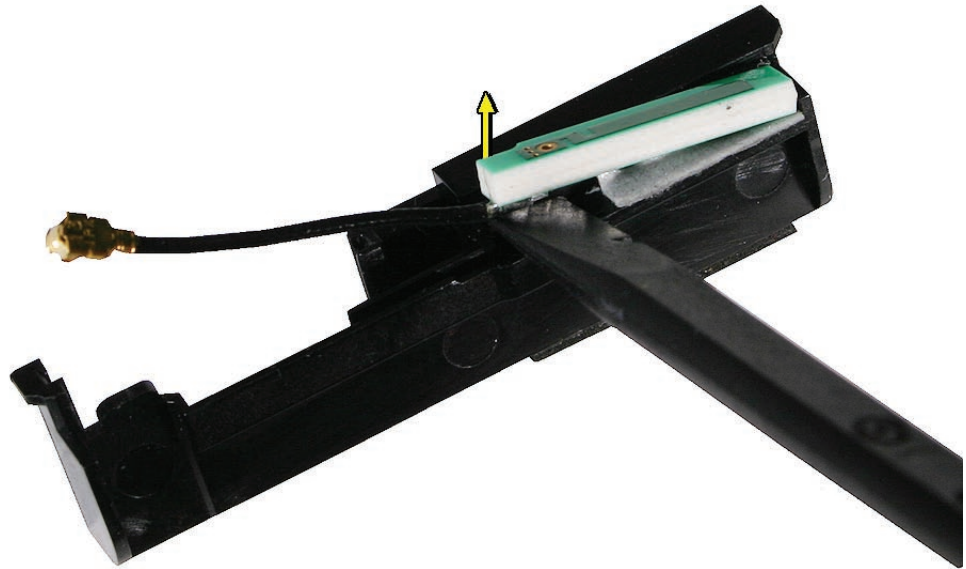

8. **Important:** If the bracket adhesive is damaged or missing, order a replacement bracket. The adhesive must be in good condition and perfectly level for proper antenna alignment.

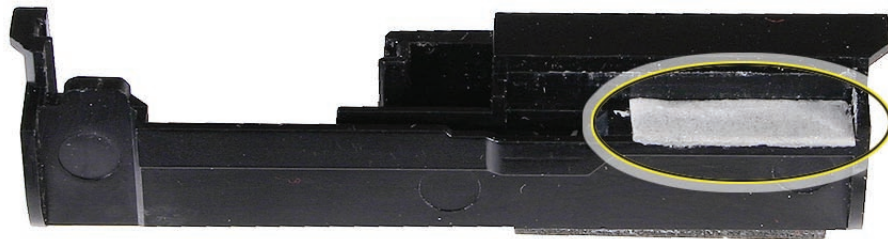

-
9. Verify that the rubber pad is in place on the bottom of the bracket. Order a new bracket, if needed.

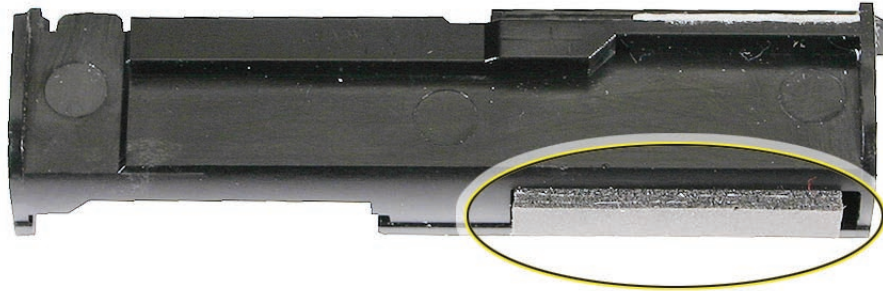

10. Install a replacement antenna as shown below. **Note:** The antenna cable is attached on the bottom of the antenna board, and routes in a channel in the bracket.

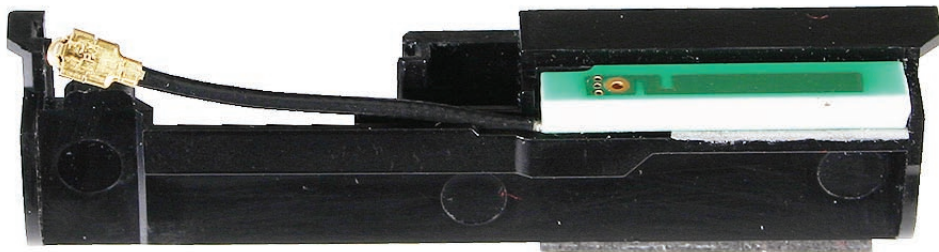

11. If present, re-install the foil EMI shield, using a reverse order of step 3 (see previous) starting with the top. If need be, the EMI shield is available to order as a separate part (922-7969).





Infrared Board

Tools

This procedure requires the following tools:

- Torx T6 screwdriver (magnetized)
- Black stick (nylon probe 922-5065) or other non-conductive nylon or plastic flat-blade tool

Preliminary Steps

Before you begin, remove the following:

- [Battery](#)
- [Top Case](#)

Part Location

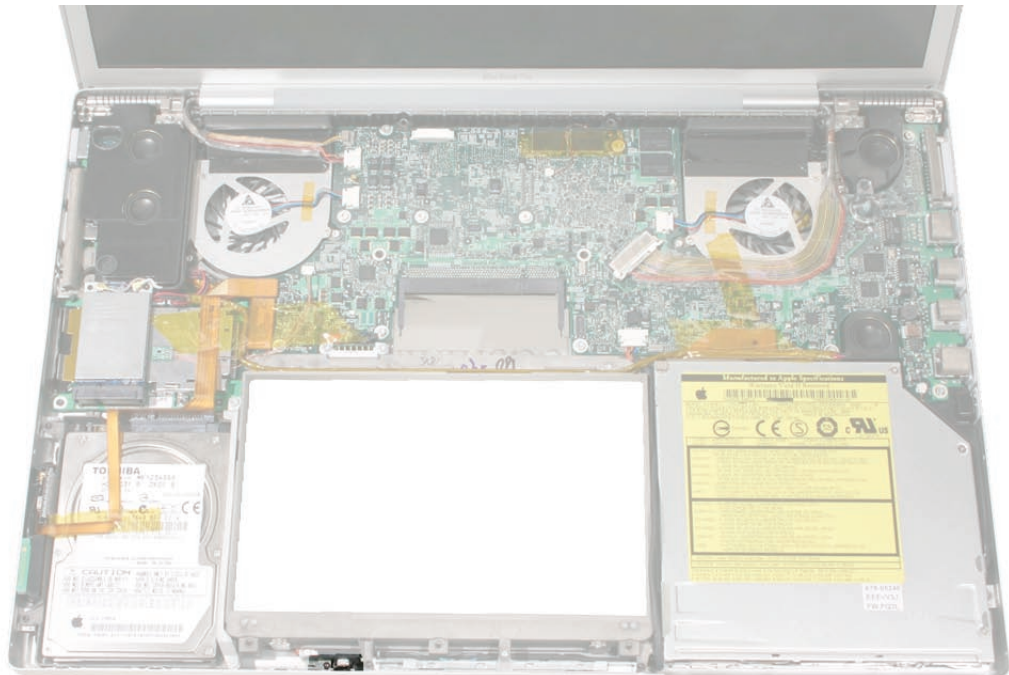

Procedure

Note: The infrared board cable (which is combined with the sleep LED light cable) is part of the bottom case assembly and is not replaceable separately.

1. Remove the Torx T6 screw.

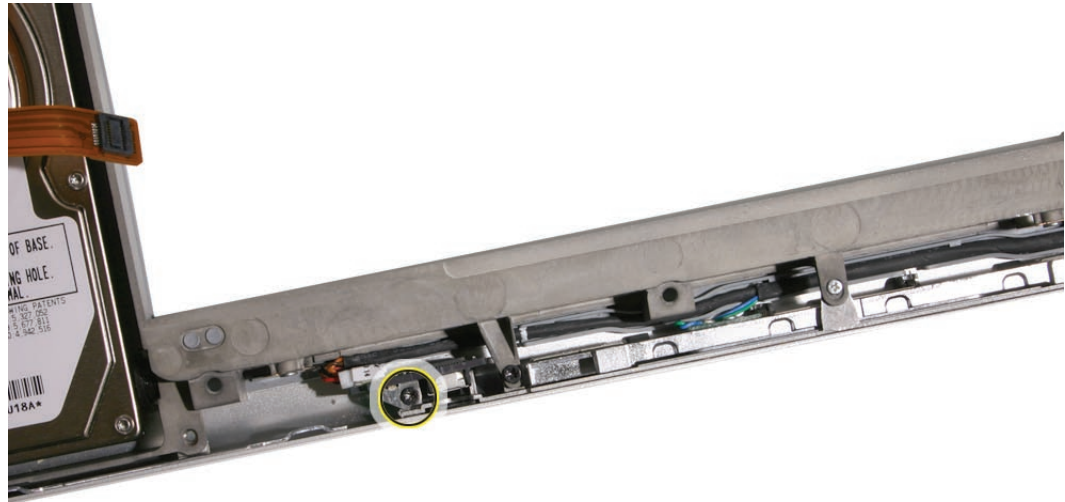

2. Lift out the infrared board.



3. Disconnect the infrared board cable.

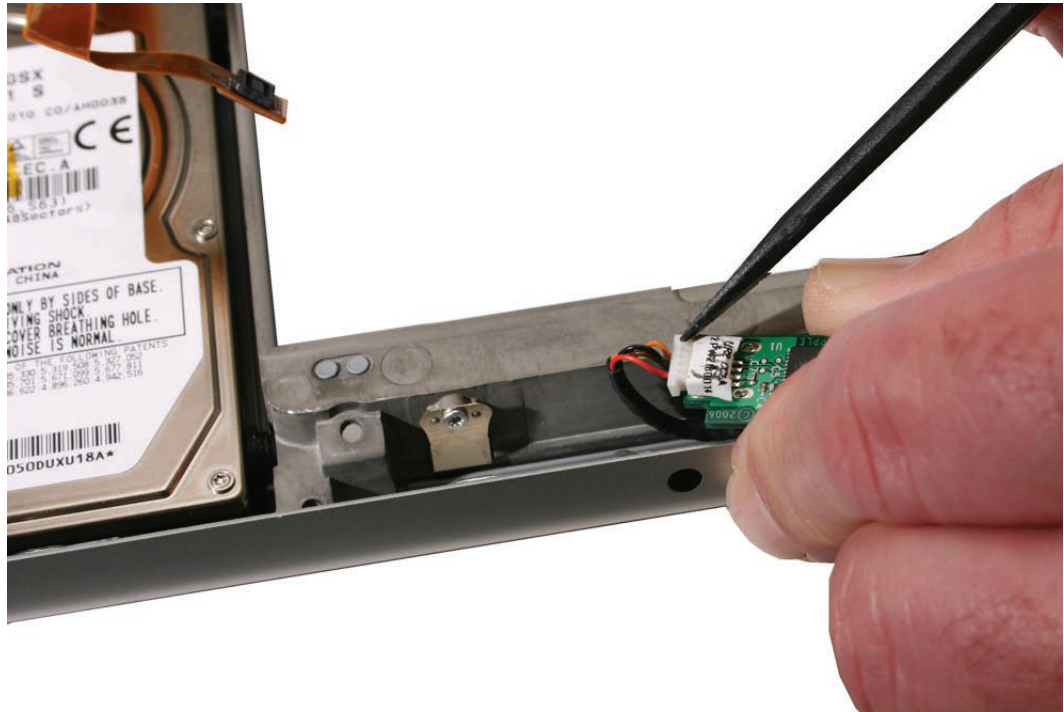

Replacement Procedure

1. Install the cable onto the infrared board.
2. Insert the card into the channel and verify that the notch in the board rests over the rounded bead, shown.

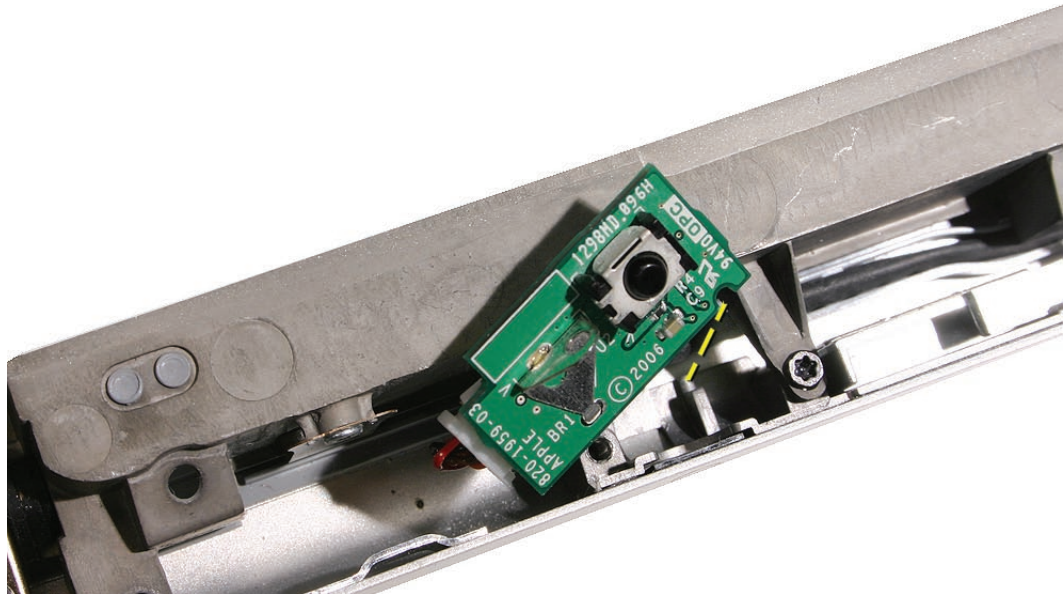

3. Push the card forward with a black stick while installing the screw, to ensure that the card secures straight.

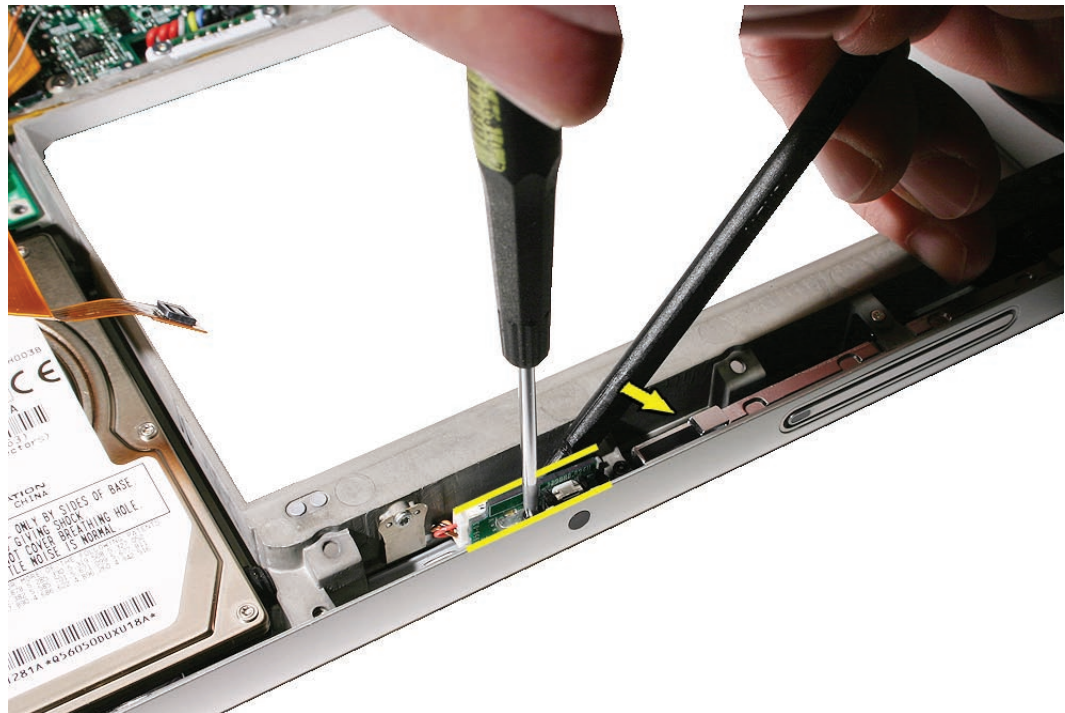

4. Verify that the top of the board is level with the top edge of the bottom case.

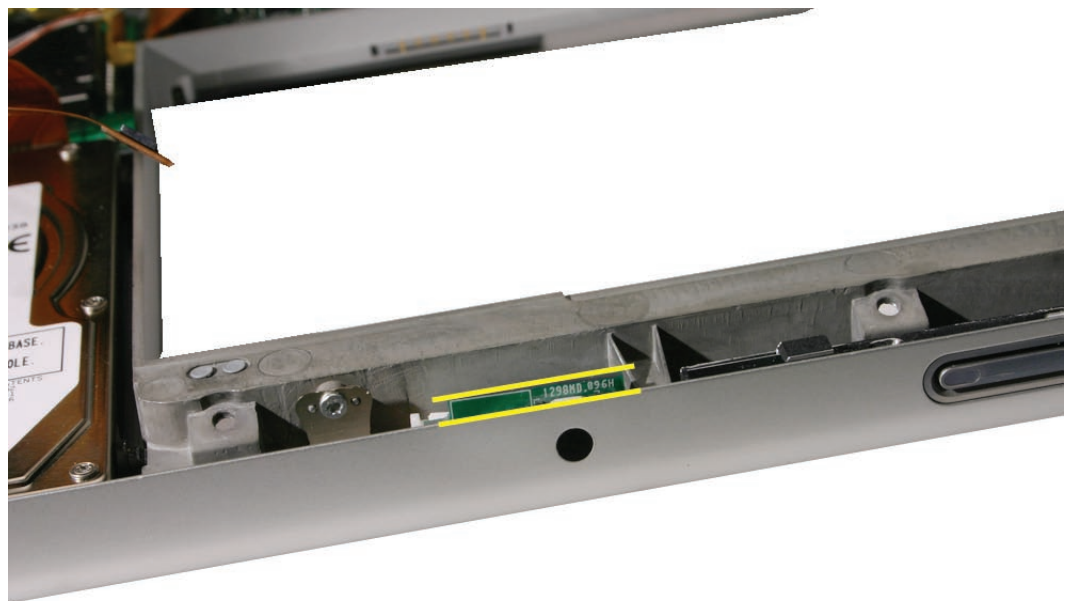



Optical Drive

Tools

This procedure requires the following tools:

- #0 Phillips screwdriver (magnetized)
- Torx T6 screwdriver (magnetized)
- Black stick (nylon probe 922-5065) or other non-conductive nylon or plastic flat-blade tool
- Kapton tape (922-1731) (0.5-inch x 12-yard roll)

Preliminary Steps

Before you begin, remove the following:

- [Battery](#)
- [Top Case](#)

Part Location

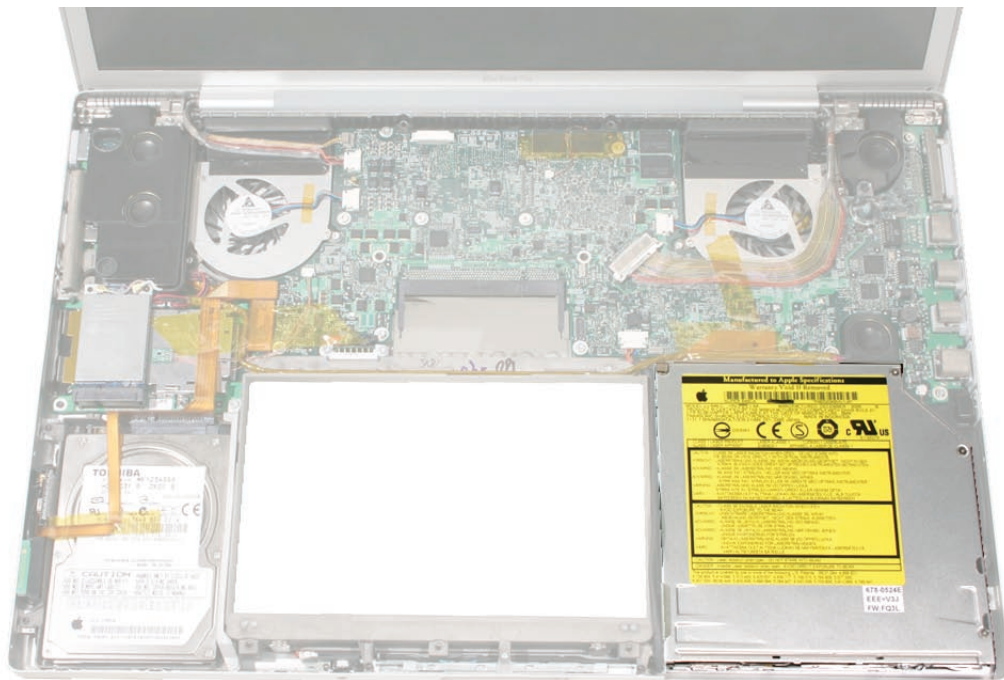

Procedure

1. Disconnect the flex connector. Peel up tape, if any.
2. Remove the three screws. Use a black stick to carefully move wires to access two of the screws, as shown below.

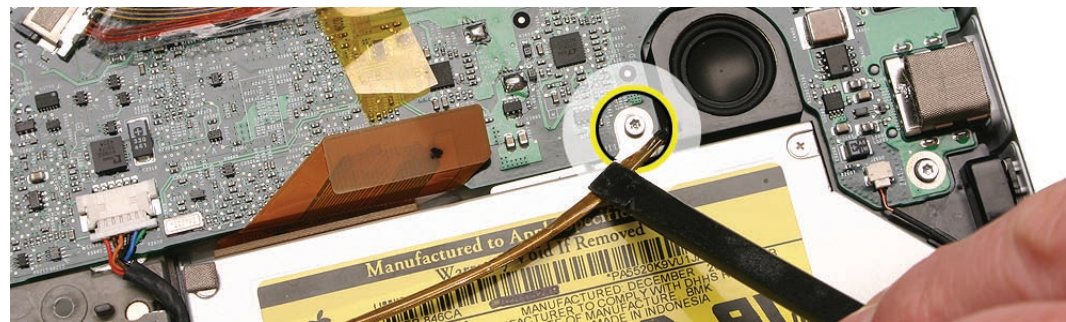

- Lift up the front of the drive and slide it forward and out.
Note: The flex cable guides under the right speaker cable.

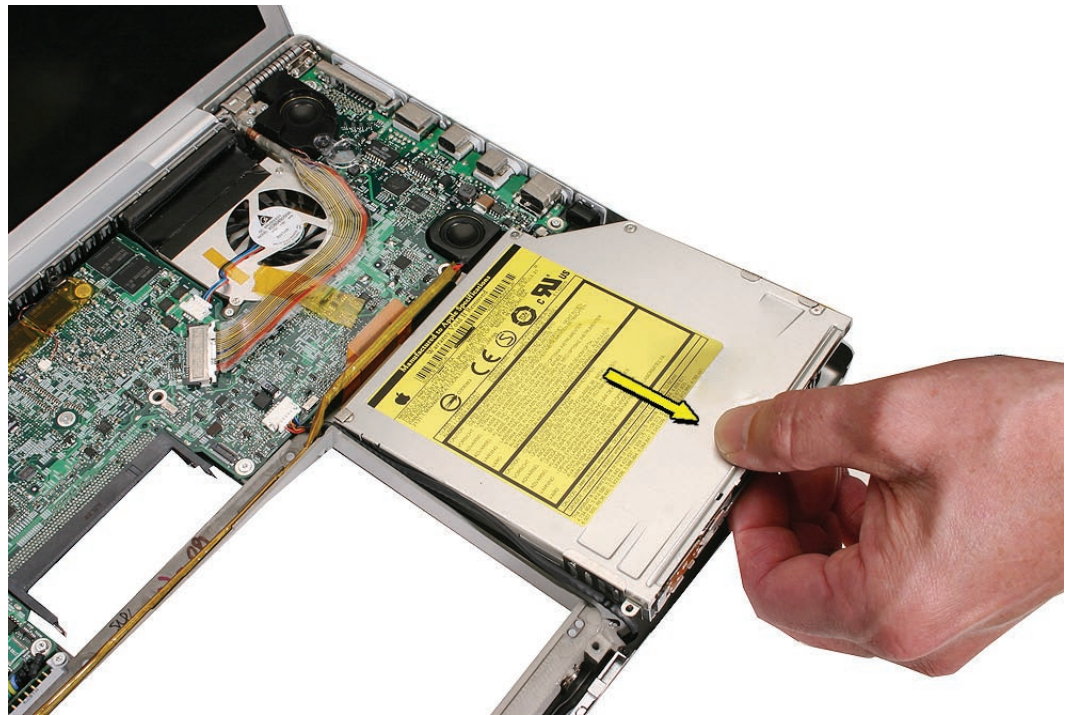

- If replacing the drive, transfer three brackets, the flex cable, and one EMI gasket (or install new) to the replacement drive.



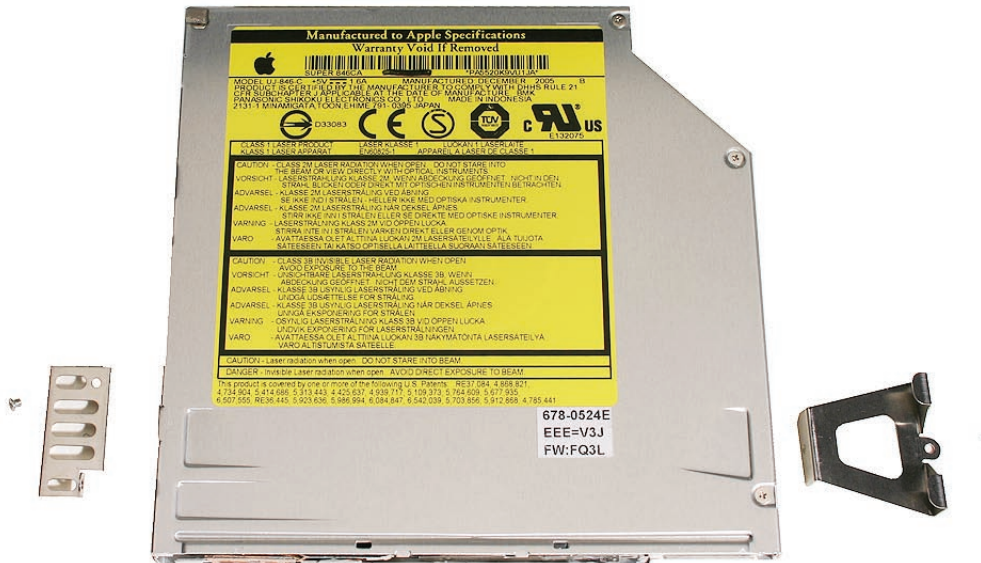
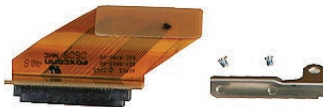

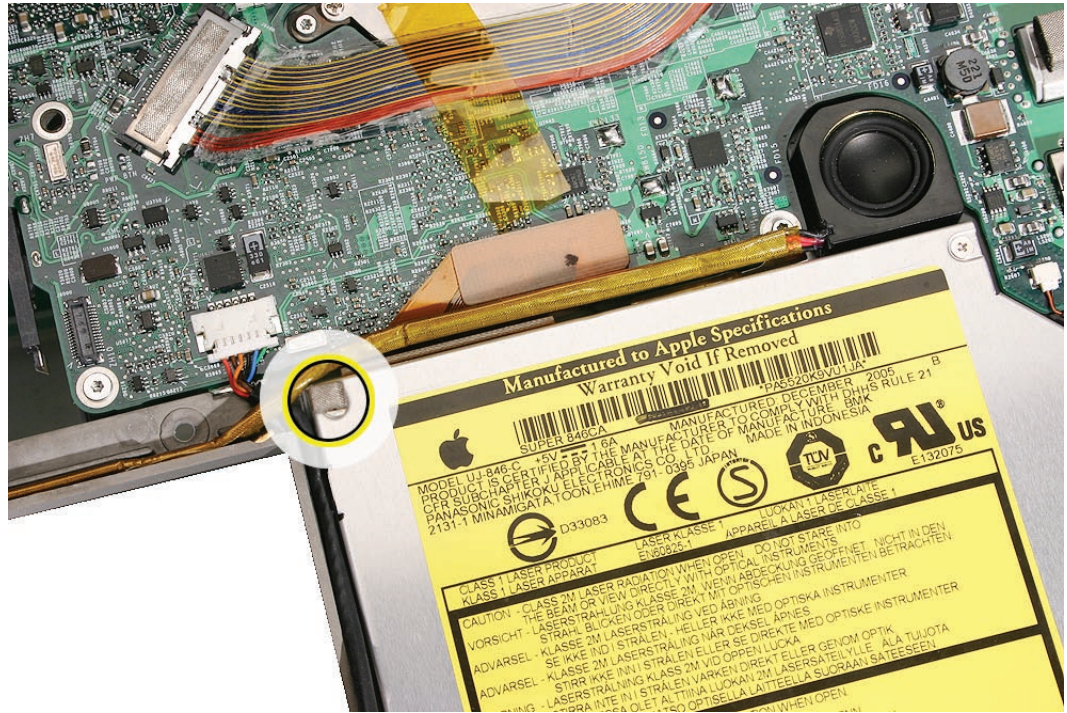

Handling Slot-Load Optical Drives

Follow the instructions in this section carefully. This procedure shows how to handle slot-load optical drives when they are outside the computer.

- Observe ESD (electrostatic discharge) guidelines when handling optical drives.



- Handle the drive only by the sides and back edge.

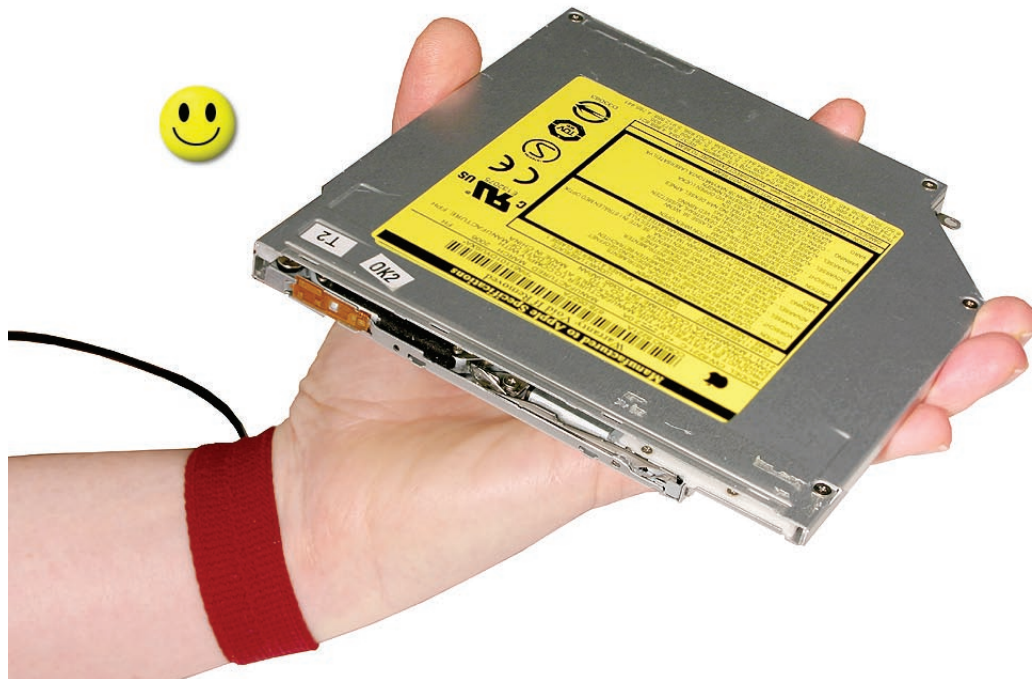

- Do not touch the front of the drive.



- Do not press on the drive or lift it by the top and bottom cover.



- Do not handle the drive by the gull wing edge only.

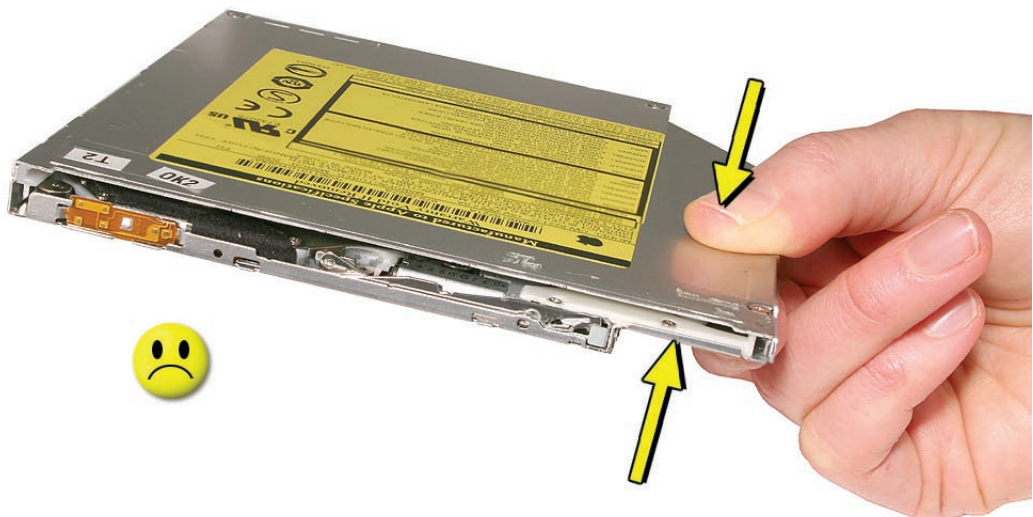

-
- When storing optical drives, use approved packaging boxes. Never stack loose drives.



- When returning a defective optical drive, use the original packaging and an antistatic bag. Pack only one drive per box.



Replacement Procedure

1. Verify that the EMI gasket is installed on the bottom case in the back of the drive bay.

Important: The optical drive must be installed so that it does not sit on top of the gasket. Insert the drive toward the logic board so that the gasket is pushed behind the drive.

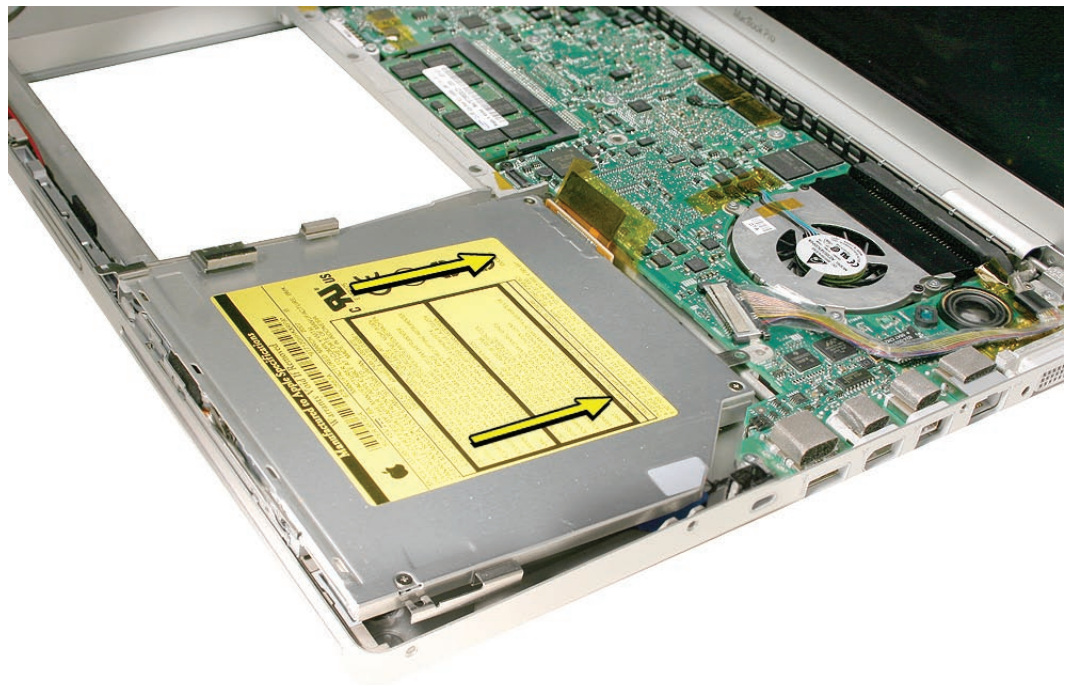
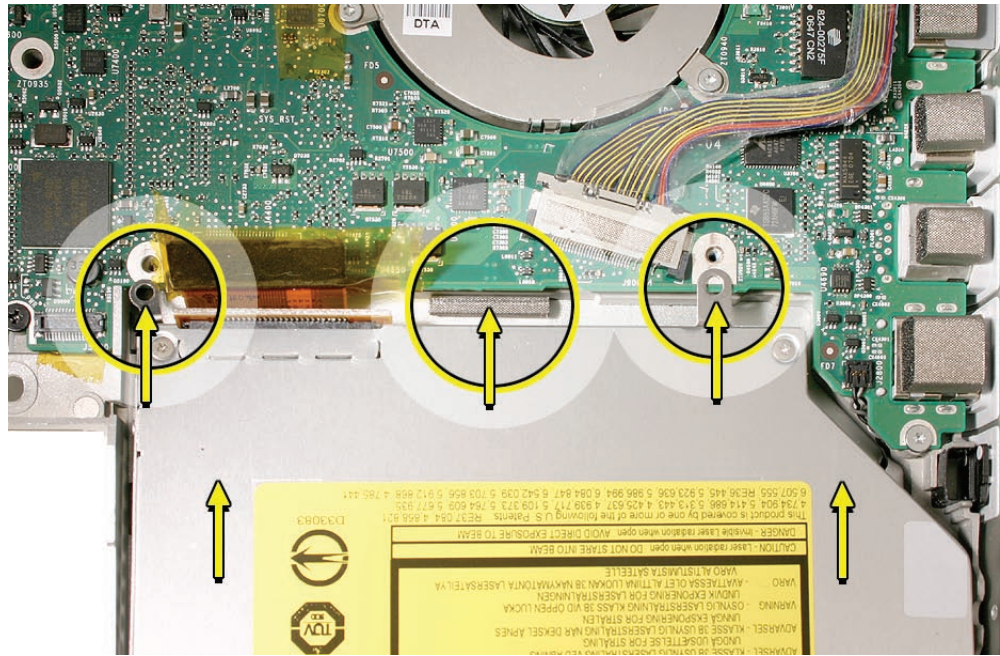

Removing a Stuck Disc from an Optical Drive

Important: This procedure applies only to 9.5-mm and 12.7-mm slot-load optical drives.

1. Remove the four identical screws that hold the top cover to the drive.



2. Slide the top cover approximately 2 mm toward the back of the drive. Lift up the top cover to remove it.



3. Check the placement of the disc. It is either clamped to the turntable at the center of the disc, or it is wedged under one or more posts at the outer edge of the disc.
4. Holding the edge of the disc, press on the center clamp or hold the posts steady as you remove the disc from the drive.
Important: Do not touch any key components located near the disc.



5. Replace the top cover on the drive so that the small hooks on the top cover fit into the slots on the bottom cover. Then slide the top cover into place.



6. Replace the four screws.
7. Install the replacement drive, and reassemble and test the computer..



Backup Battery

Tools

This procedure requires the following tools:

- Needle-point metal probe
- Black stick (nylon probe 922-5065) or other non-conductive nylon or plastic flat-blade tool

Preliminary Steps

Before you begin, remove the following:

- [Battery](#)
- [Top Case](#)
- [Optical Drive](#)

Part Location

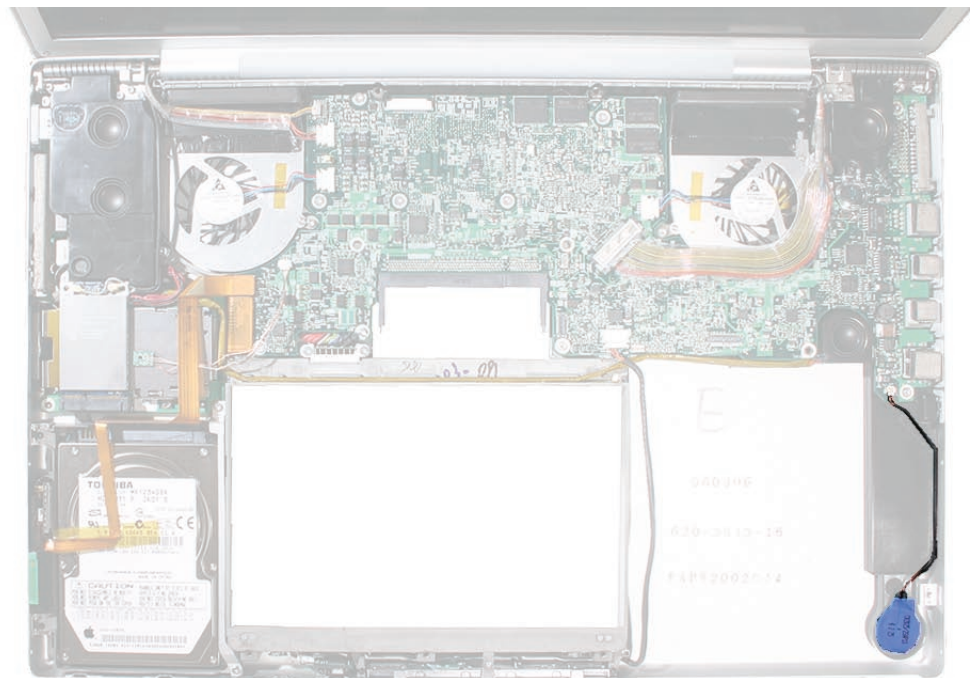

Procedure

1. (a) For the MacBook Pro (17-inch), use a needlepoint probe to disconnect the cable connector from the logic board, as shown below. **Warning:** When using a needlepoint probe, great care must be used to avoid slipping off the connector and damaging components.

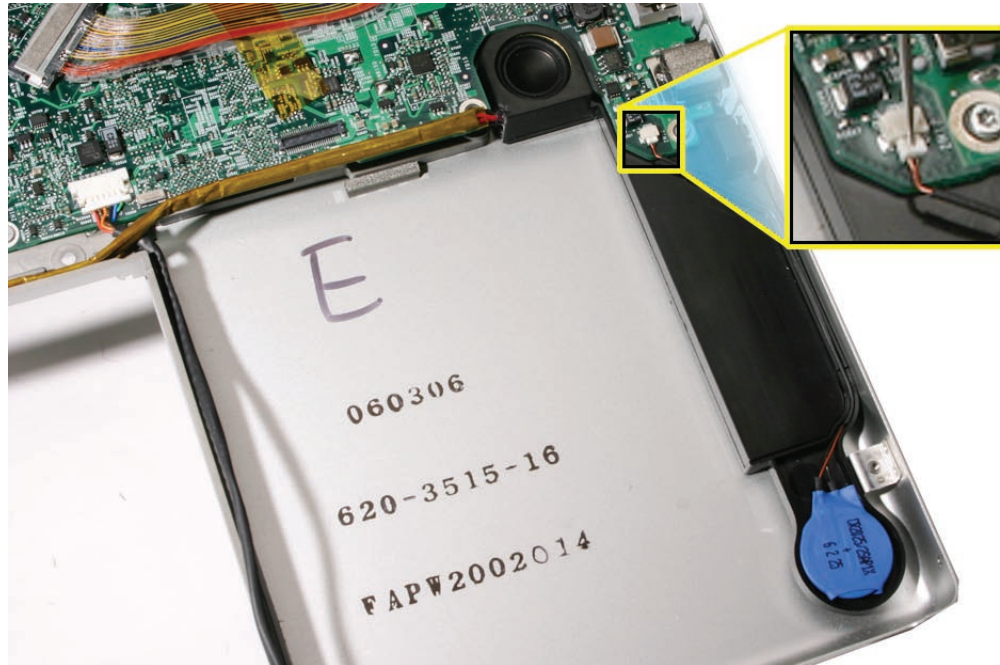

- (b) For the MacBook Pro (17-inch Core 2 Duo, 2.4GHz and Early 2008), sandwich the connector between a finger or thumb on top and a black stick under the cable and as close to the JST connector as possible, and gently pull it straight up and out of its well.

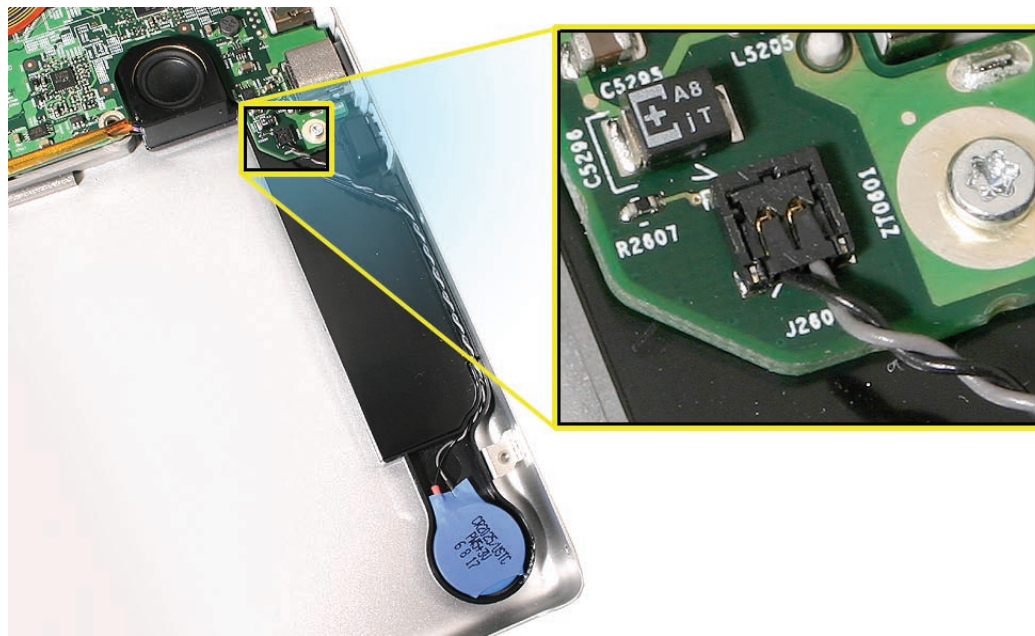

2. Pry up the backup battery from the well in the right speaker.



3. To install a replacement backup battery, remove the adhesive protector and press the battery into place in the same well that it was removed from the right speaker.
4. Guide its cable into the channel along the right speaker.
5. Connect the cable to the logic board.

Note 1: The MacBook Pro (17-inch) connector is keyed to install only one way.

Note 2: The MacBook Pro (17-inch Core 2 Duo, 2.4GHz and Early 2008) JST connector can be reconnected using either your finger or a black stick.

JST Connectors

1. To disconnect a JST connector, sandwich the connector firmly between a finger on top and a black stick under the cabling next to the connector, then lift (as in the animation below).

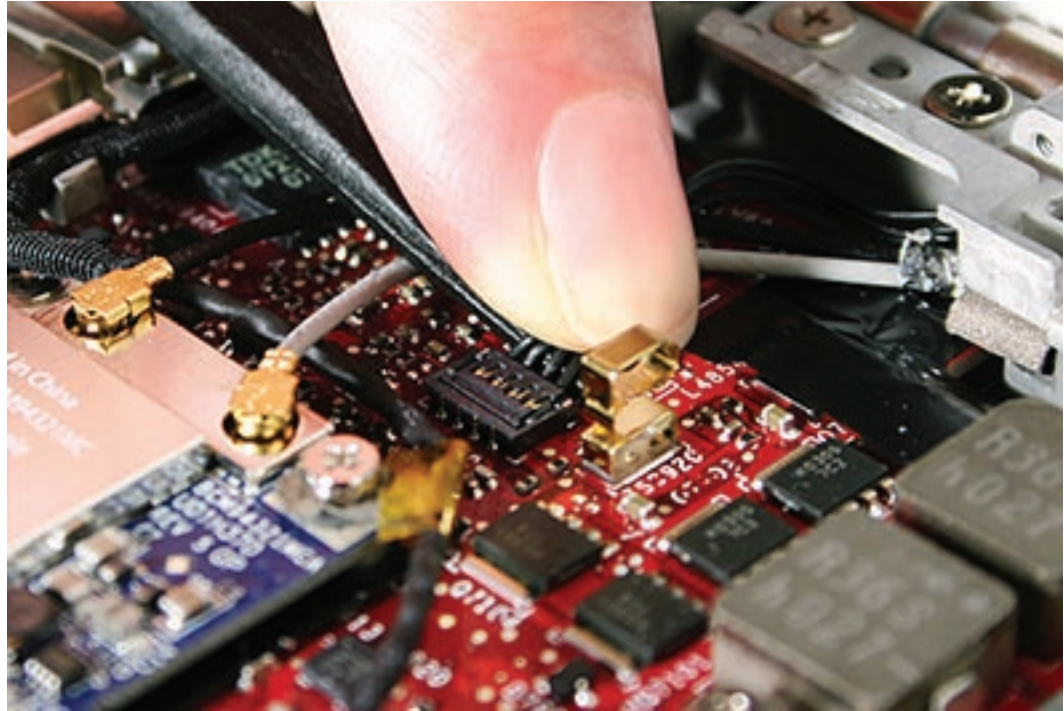

2. To reseal or reconnect a JST connector, use a black stick or your finger to snap it into place, making sure the connector sits perfectly flat and flush with the sides of the connector well.

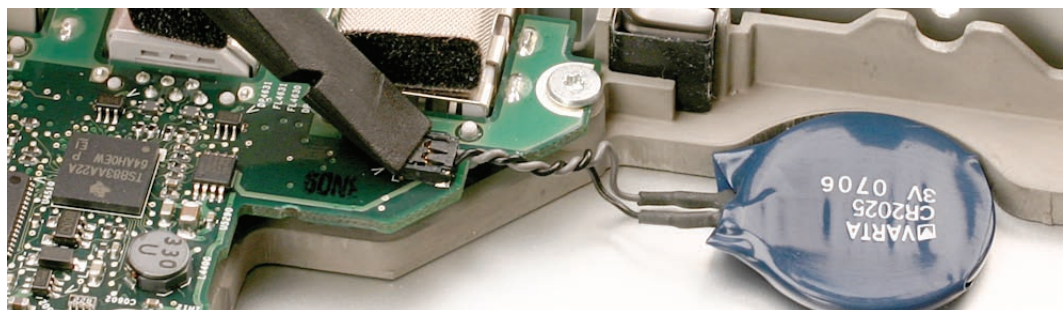
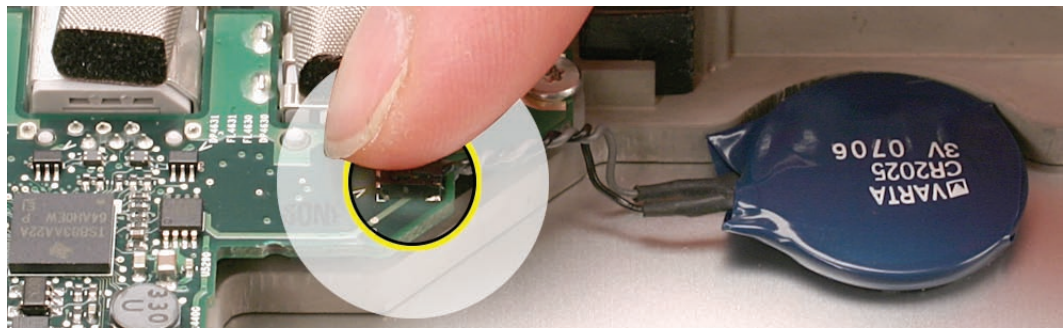

Note: Given a very keen eye, one way to distinguish the right side up of a JST connector is by looking for the word 'push' on the top side of the connector, as shown below.





Ambient Light Sensors

Tools

This procedure requires the following tools:

- Torx T6 screwdriver (magnetized)

Preliminary Steps

Before you begin, remove the following:

- [Battery](#)
- [Top Case](#)

Part Location

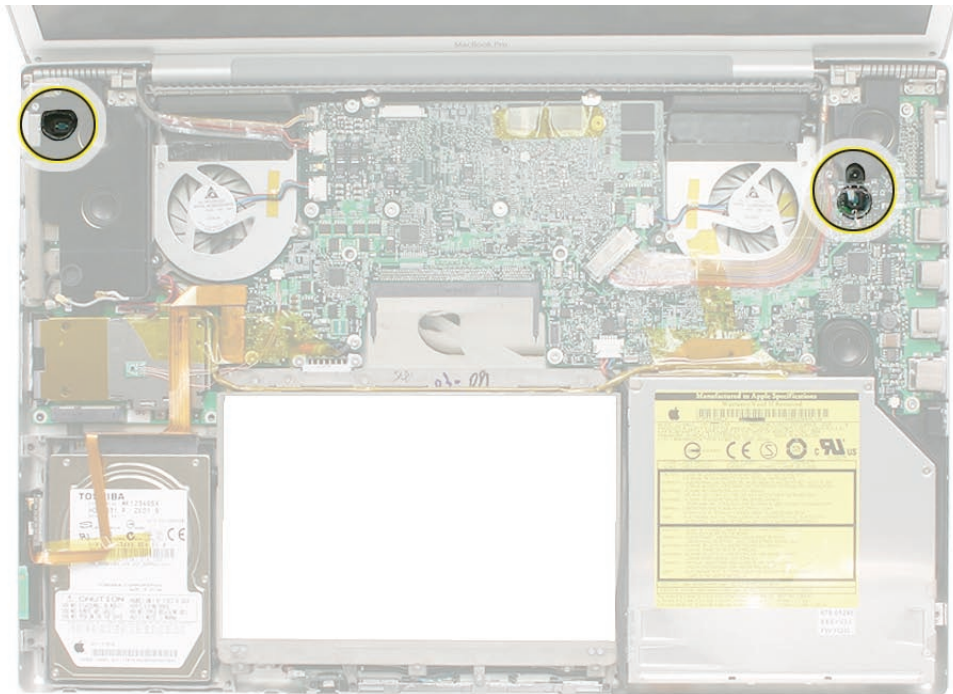

Procedure

The **right ambient light sensor** is part of the logic board and is not separately replaceable, but has a removable dust cover that attaches with a small screw to the right speaker.

The **left ambient light sensor** is part of the left I/O board and is not separately replaceable, and has a dust cover glued onto the left speaker that is also not separately replaceable.

To remove the right sensor's dust cover:

1. Remove the Torx T6 screw shown.

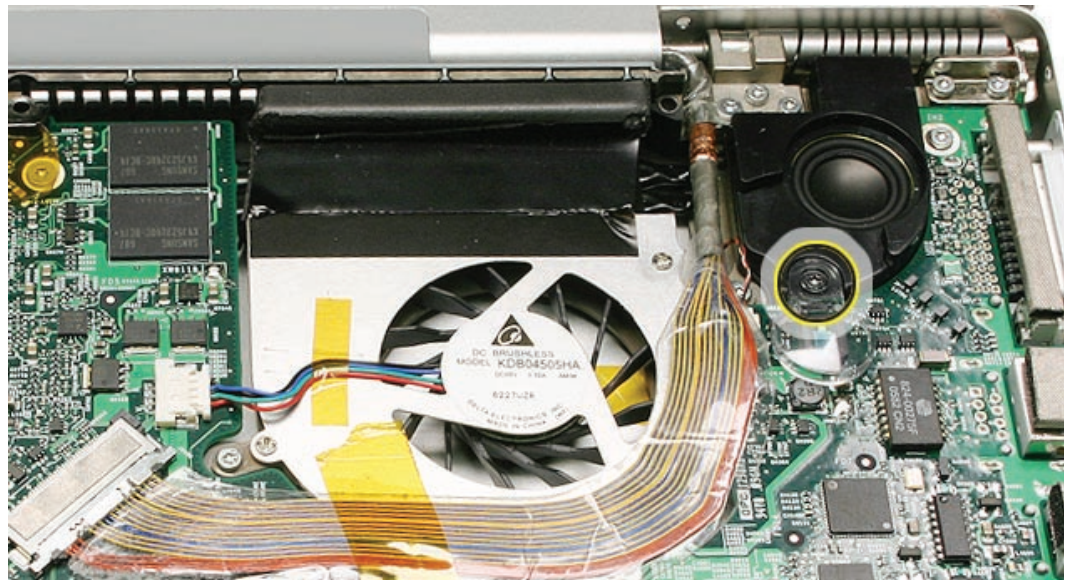



Speakers and Microphone

The right and left speakers are two separately replaceable parts.

The left speaker also contains a separately replaceable microphone.

Tools

This procedure requires the following tools:

- Torx T6 screwdriver (magnetized)
- Black stick (nylon probe 922-5065) or other non-conductive nylon or plastic flat-blade tool
- Kapton tape (922-1731) (0.5-inch x 12-yard roll)

Preliminary Steps

Before you begin, remove the following:

- [Battery](#)
- [Top Case](#)
- [AirPort Extreme Card](#) (for left speaker)
- [Logic Board](#) (for right speaker)

Part Location

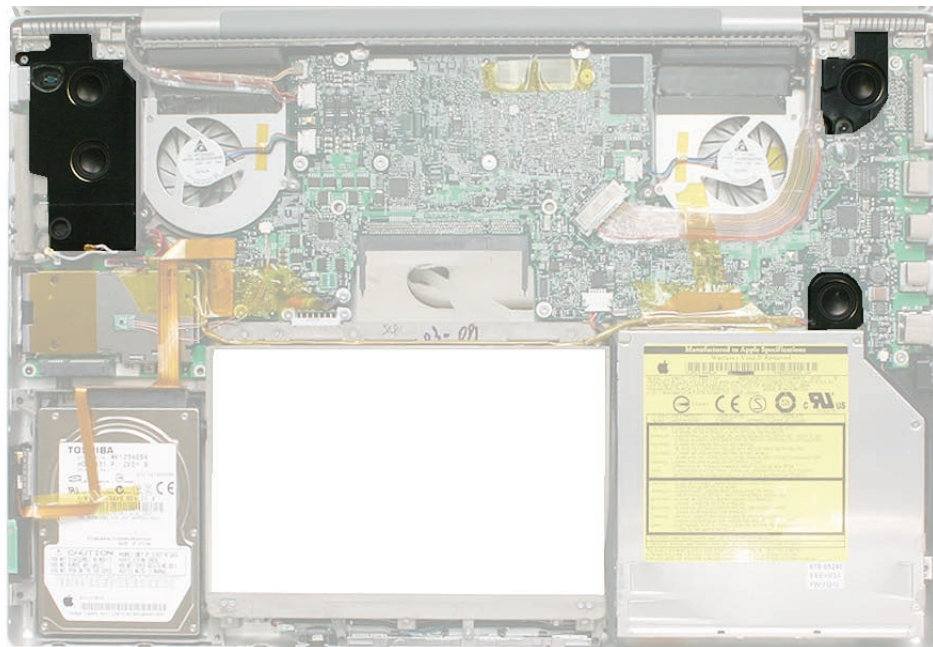

Procedure

To remove the microphone:

Note: The microphone does NOT have to be removed from the left speaker if not replacing the microphone or speaker.

Note: Some photo details below may differ slightly from the model of 17-inch MacBook Pro you are repairing; however, the procedure itself remains consistent for any of the models.

1. Use the flat end of a black stick to pry the microphone boot out of its well in the left speaker.

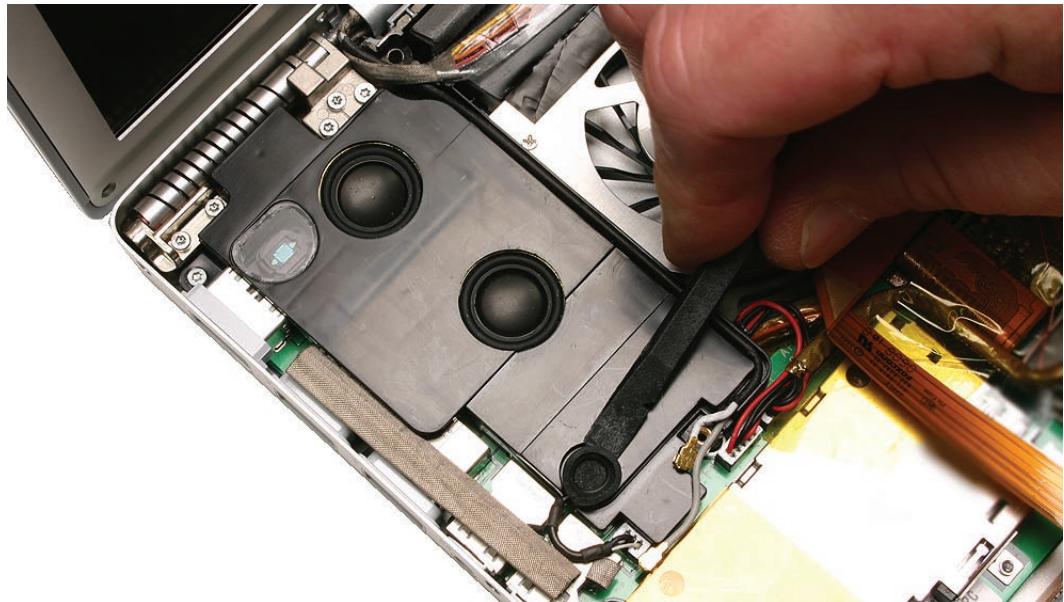

2. Disconnect its connector from the left I/O board.

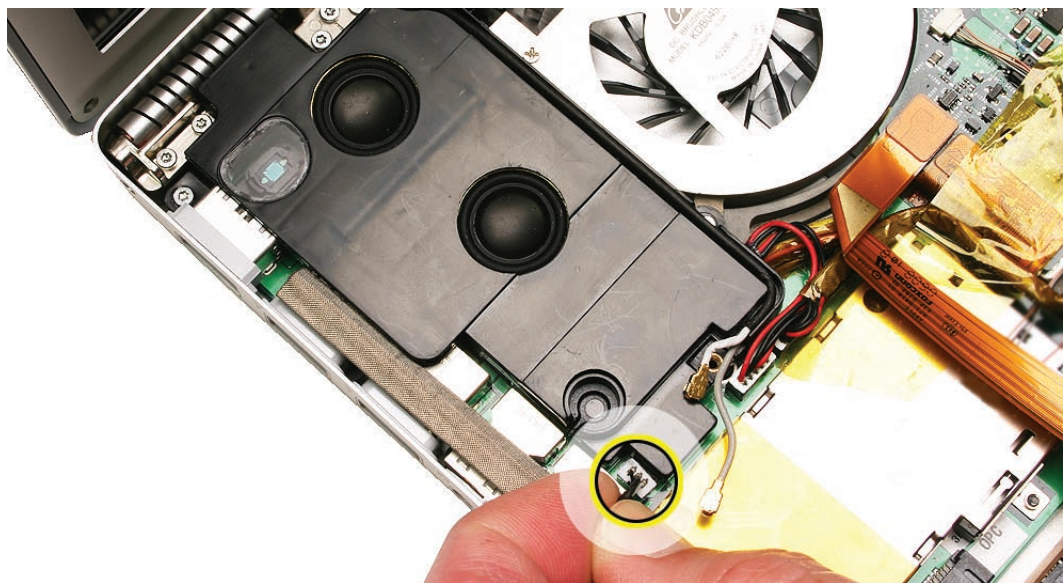

To remove the left speaker:

1. Lift the antenna wires out of the channel along the right side of the speaker.

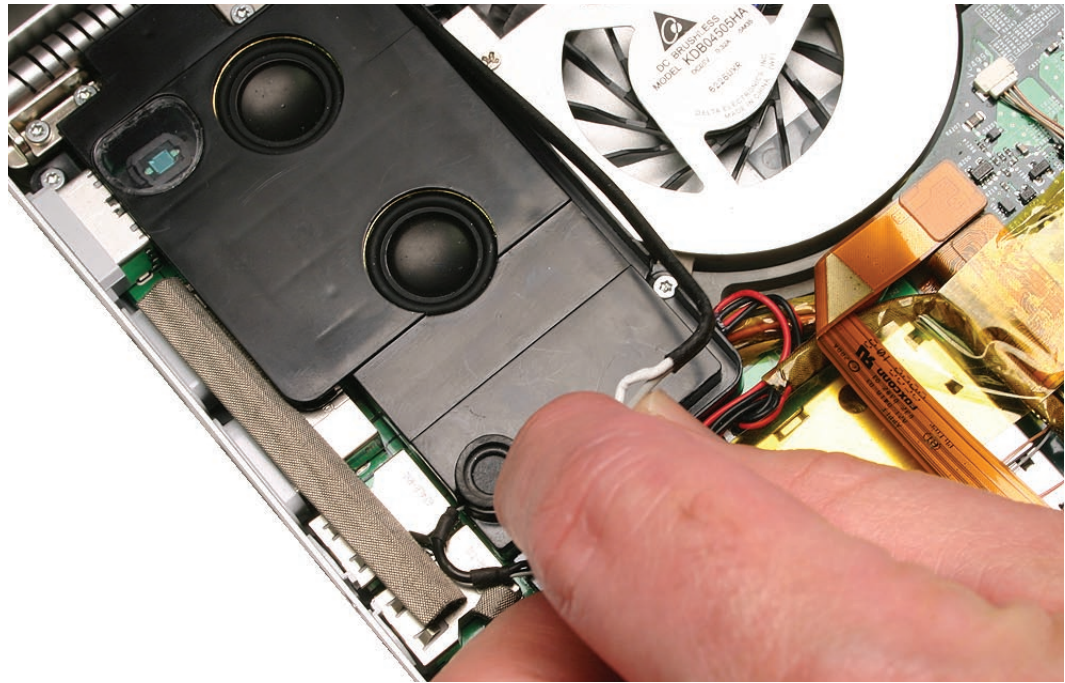

2. Remove two screws.

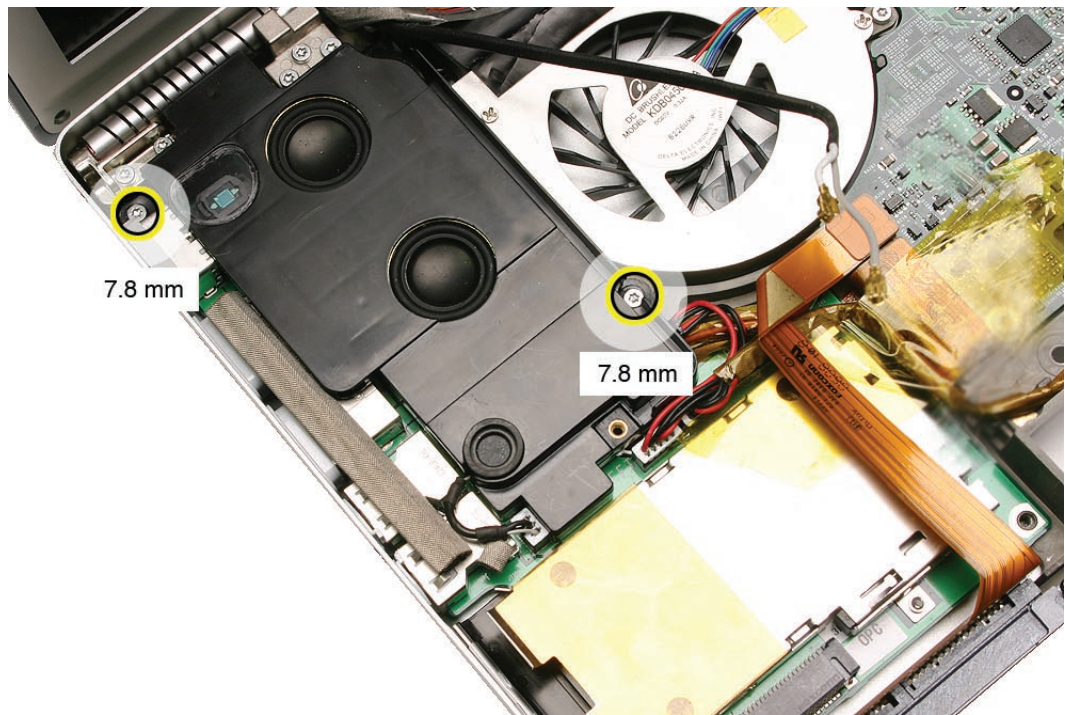

3. Disconnect the speaker cable and the microphone cable, and lift out the speaker.

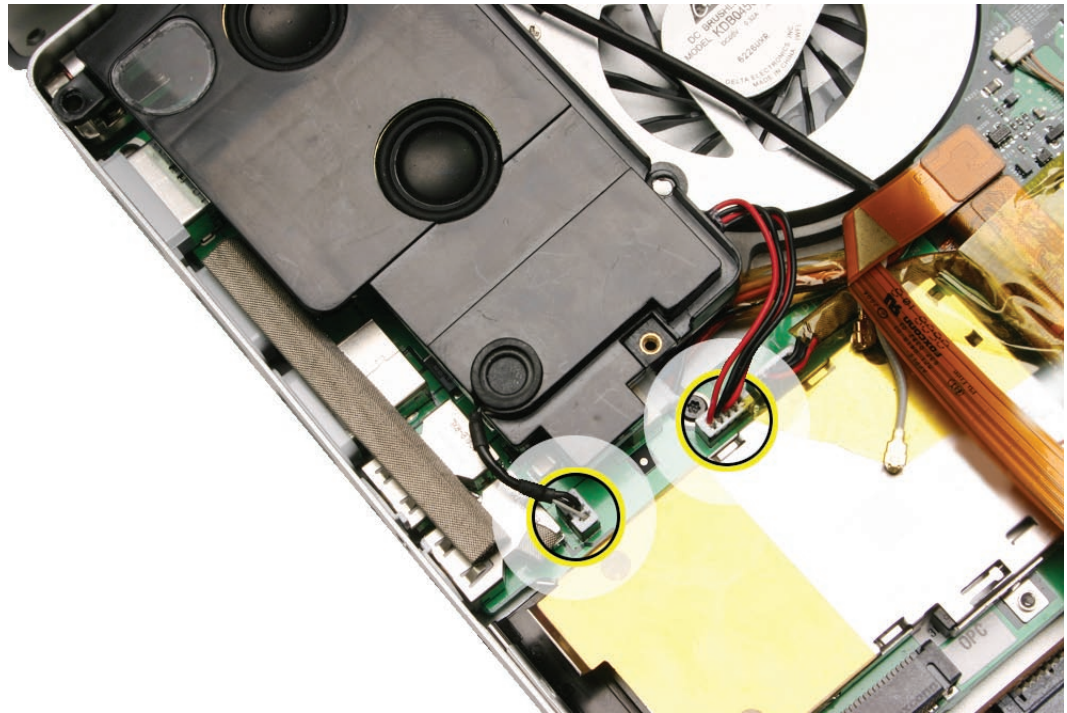

Replacement Notes:

- Verify that the antenna cables lay flat within the channel along the edge of the speaker.

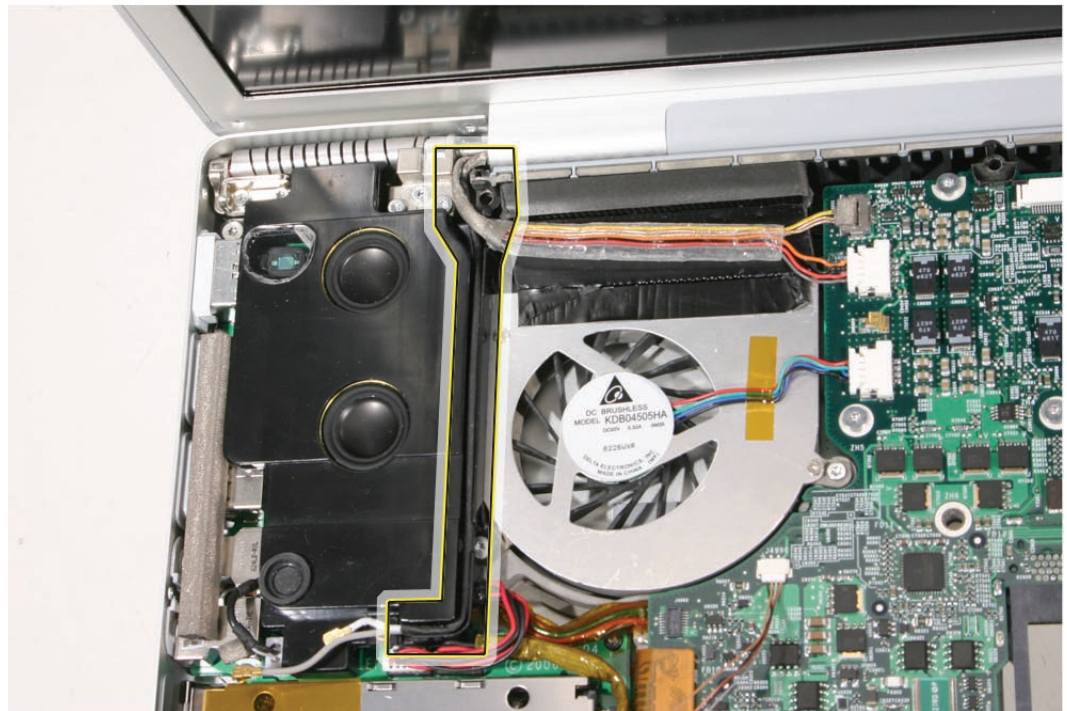

- If not, use Kapton tape to secure, as shown.

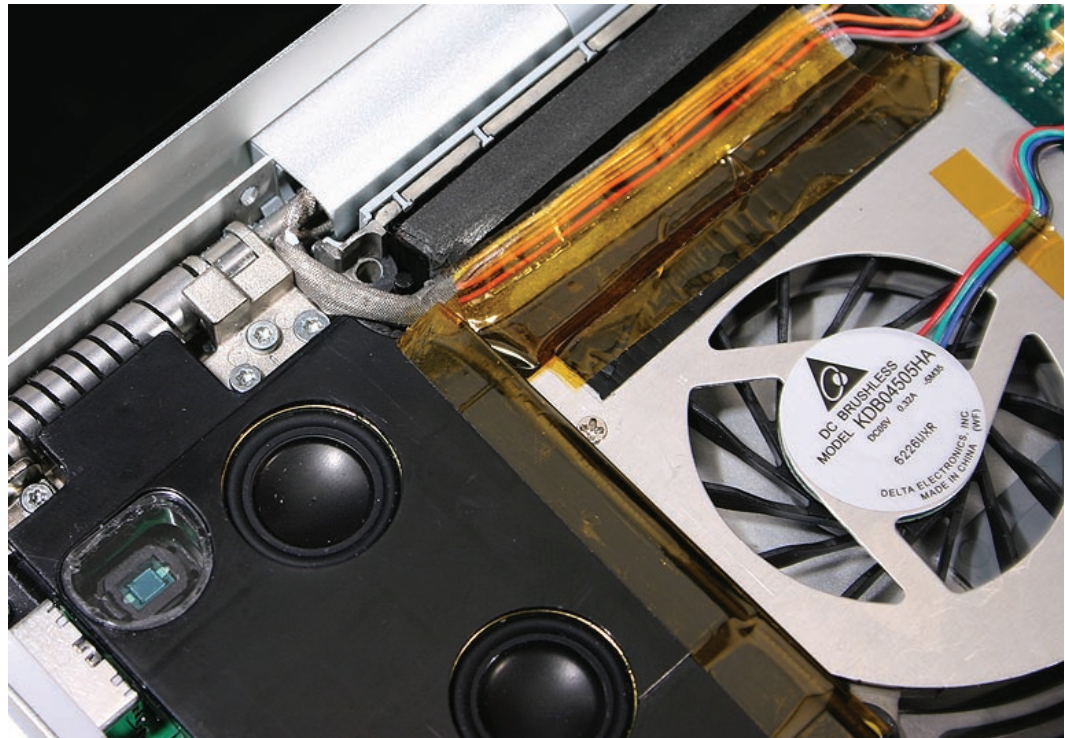

- And verify that the cables for the antennas, and camera and inverter, route to the left of the pin and screw hole at the top right corner of the speaker.

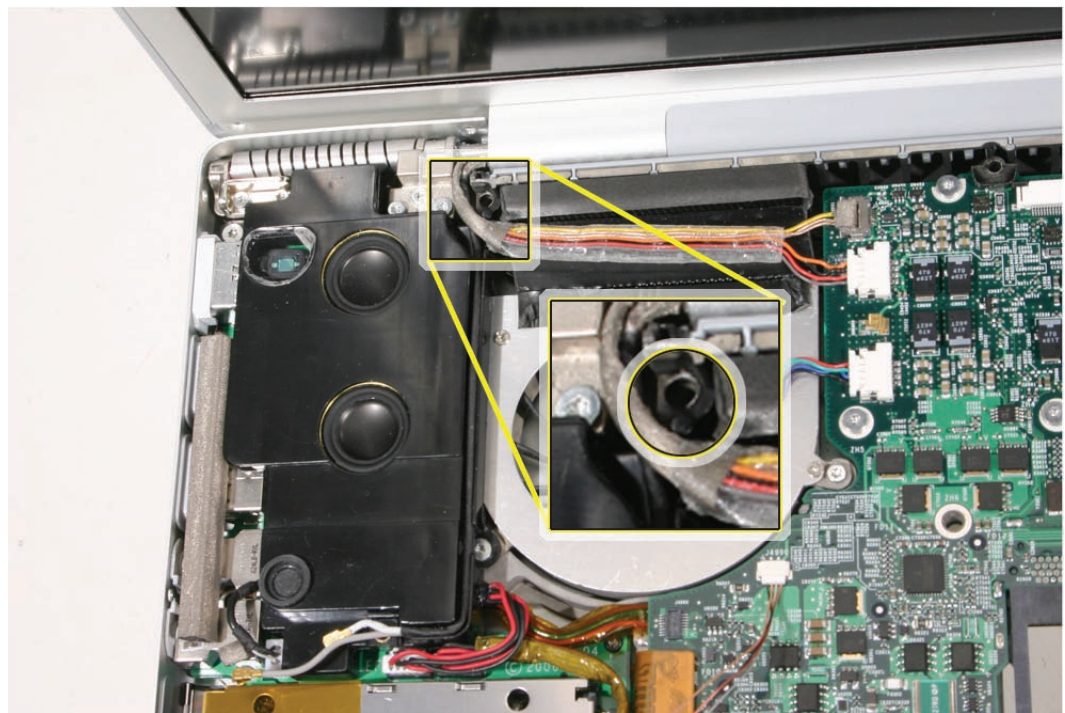

To remove the right speaker:

1. Once the logic board is removed, lift out the right speaker, guide its cable out of the channel above the battery well, and disconnect its connector from the left I/O board.

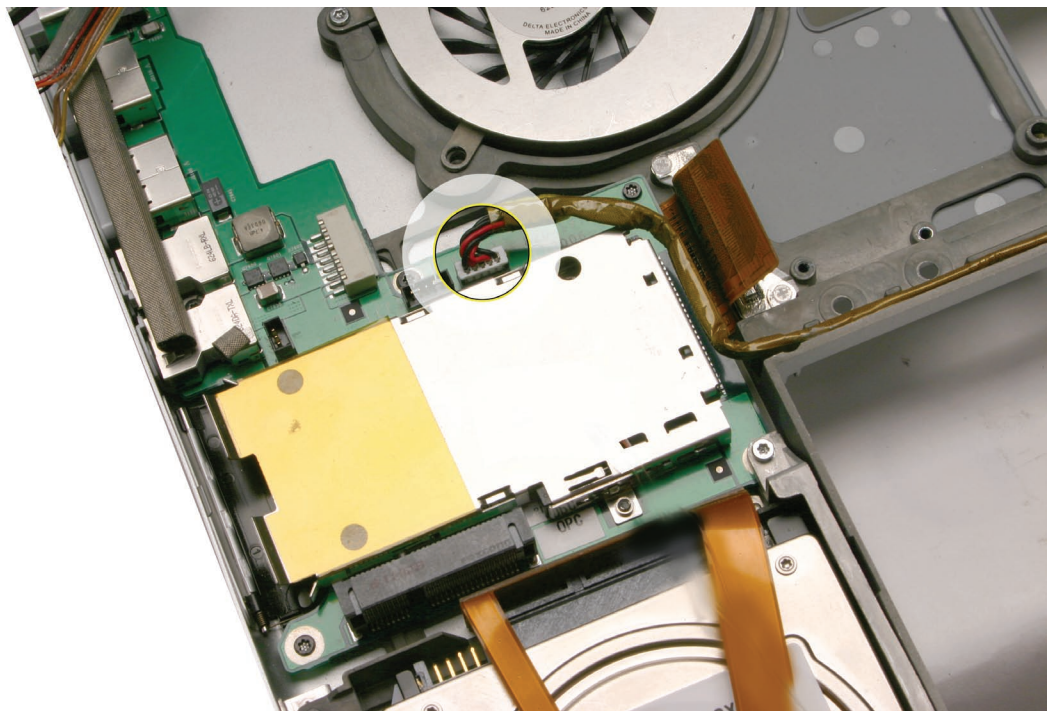
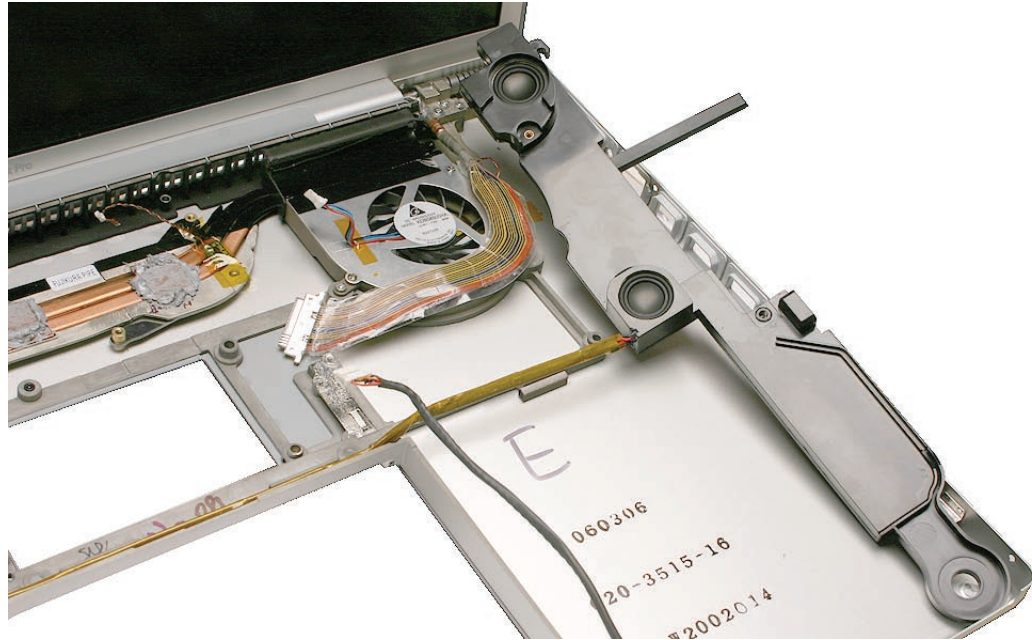



Left I/O Board

Tools

This procedure requires the following tools:

- Torx T6 screwdriver (magnetized)
- #0 Phillips screwdriver (magnetized)
- Black stick (nylon probe 922-5065) or other non-conductive nylon or plastic flat-blade tool

Preliminary Steps

Before you begin, remove the following:

- [Battery](#)
- [Top Case](#)
- [AirPort Extreme Card](#)
- [Left Speaker](#)

Part Location

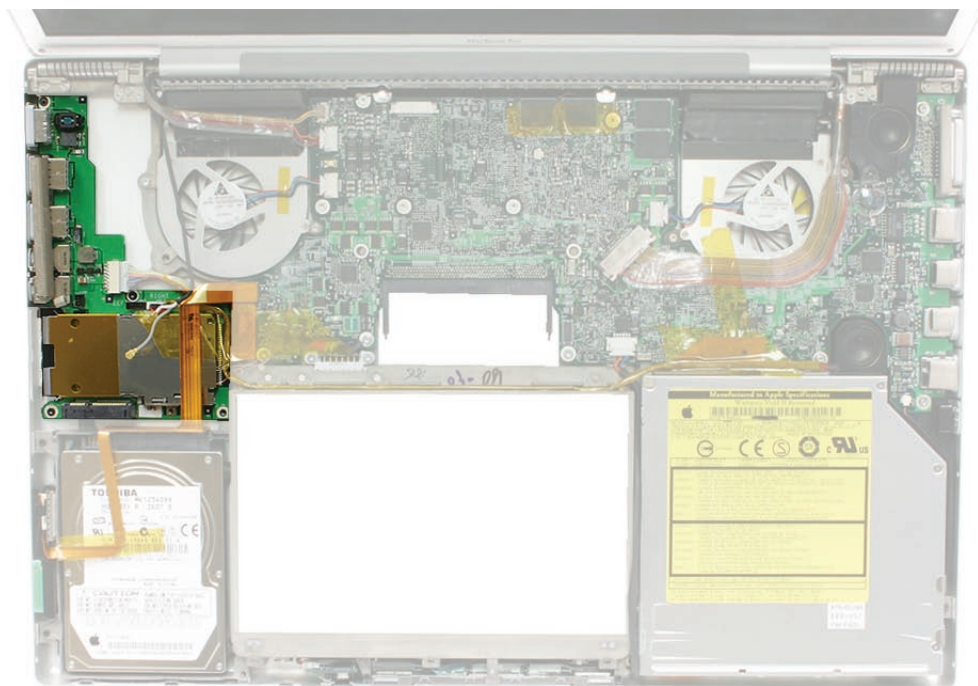

Procedure

Note: Some photo details below may differ slightly from the model of 17-inch MacBook Pro you are repairing; however, the procedure itself remains consistent for any of the models.

1. Disconnect the hard drive and ExpressCard flex cables, as shown below.

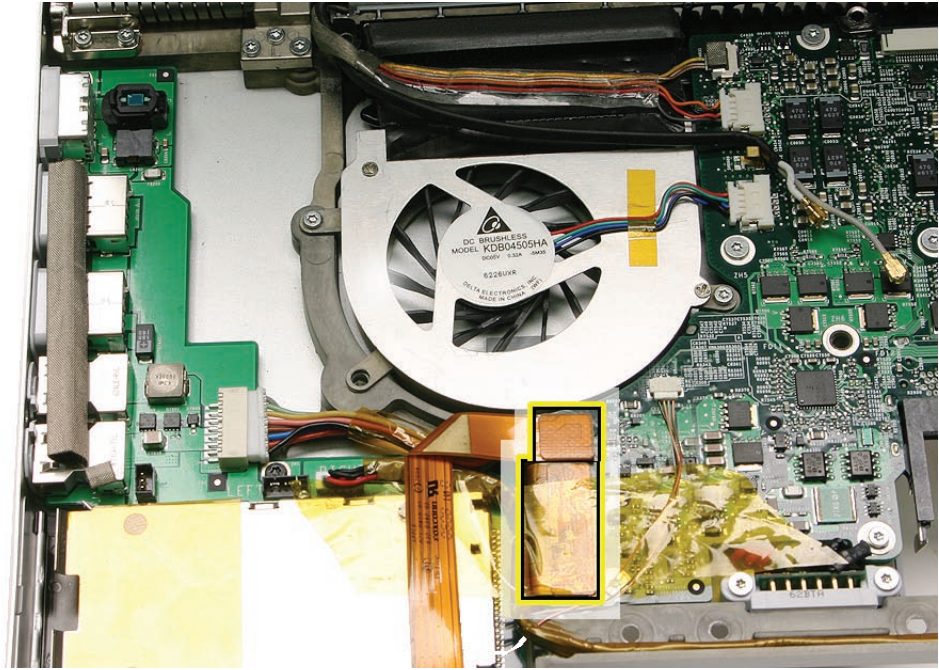

2. Disconnect the left I/O cable and right speaker cable.

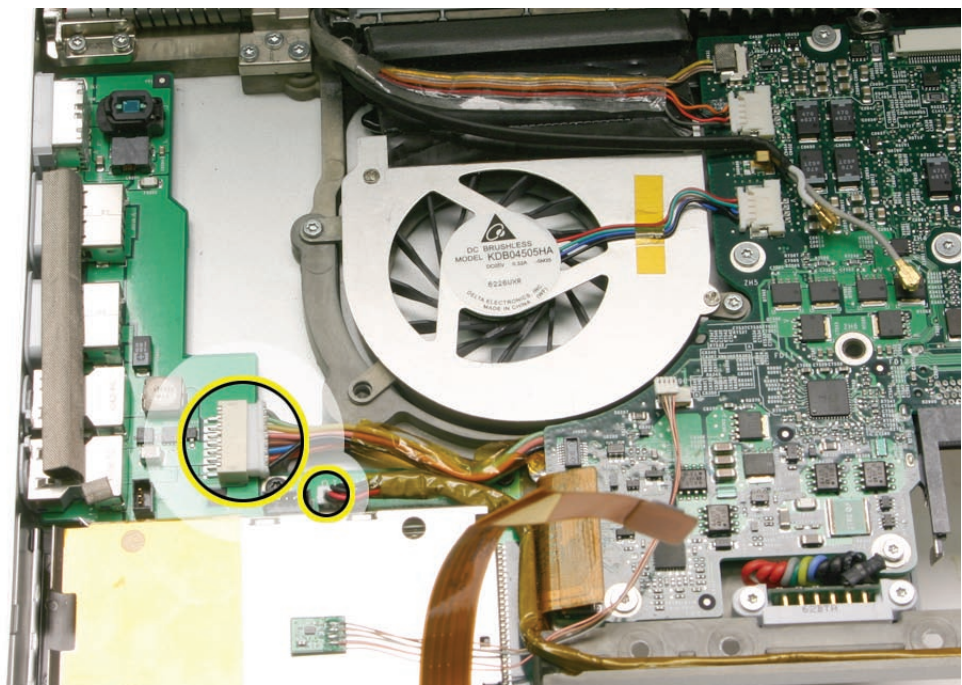

3. Remove the four Torx T6 screws.

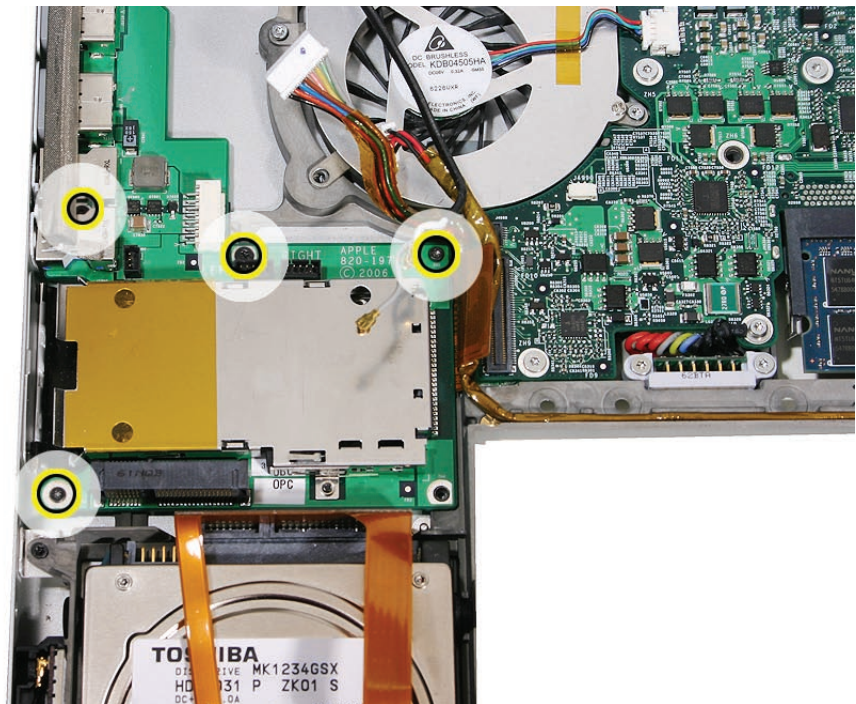

4. Lift slightly and slide the left I/O board assembly away from the port openings to remove.



- The ExpressCard cage assembly is attached to the left I/O board. Peel back the Mylar that covers the top two screws and remove all four screws.

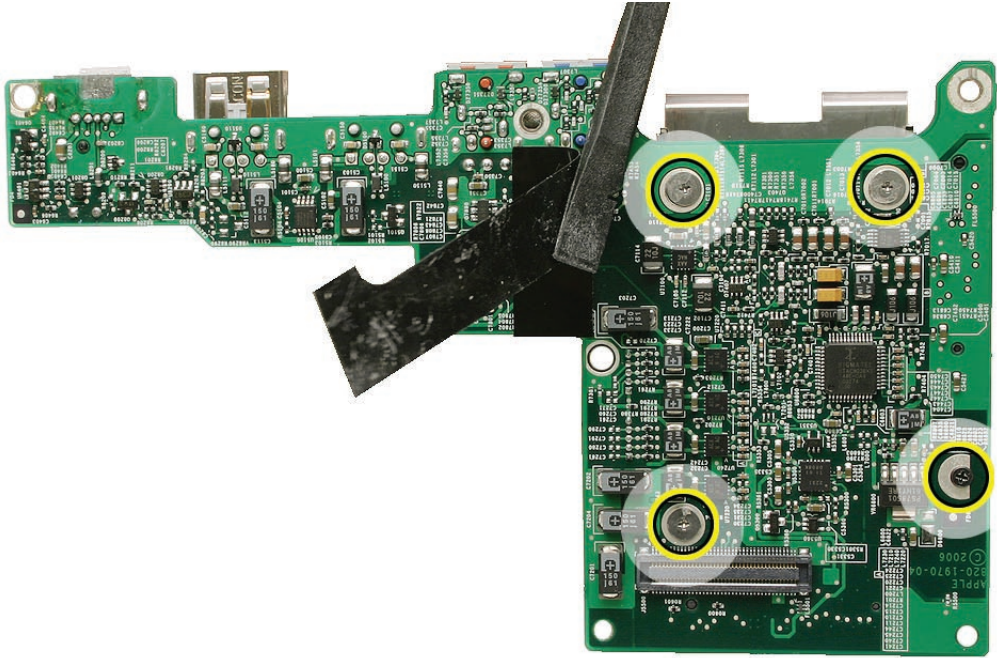

(b) The MacBook Pro (17-inch 2.4GHz and Early 2008 models) will have a black Mylar film underneath the screws (unlike Kapton below), so no need to remove the film. Just remove the four pocket screws.

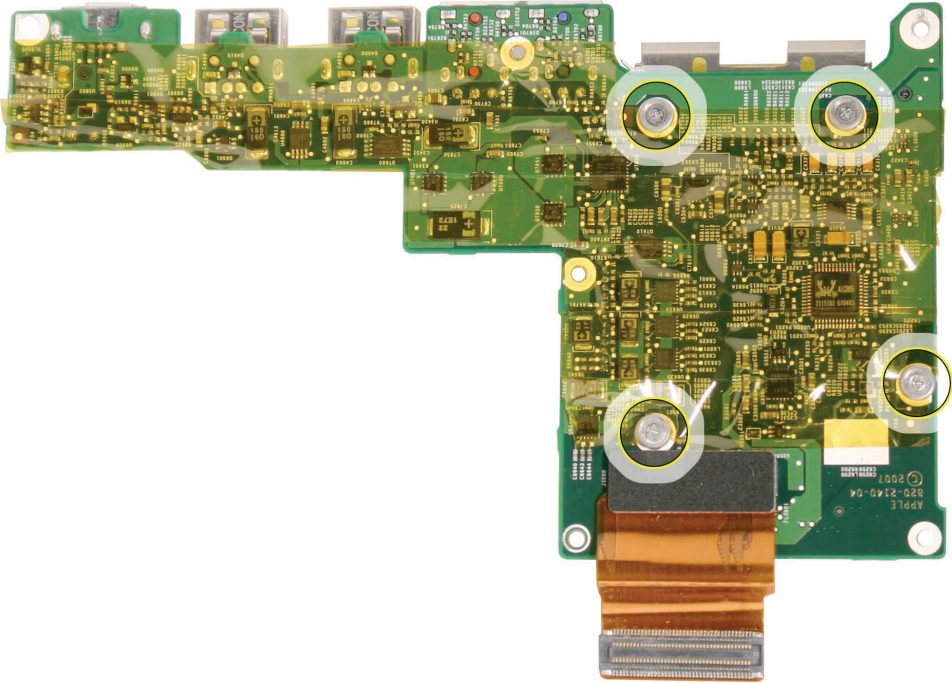

6. Lift off the card cage.

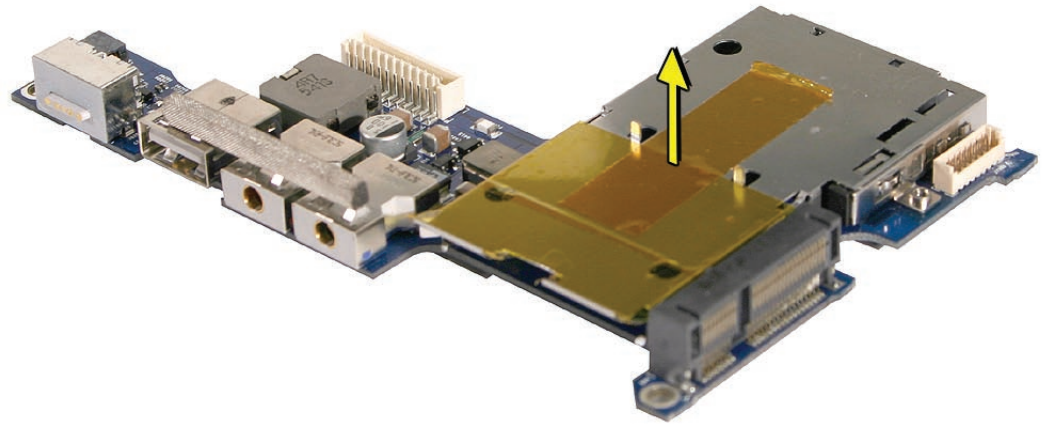

(b) The MacBook Pro (17-inch 2.4GHz) ExpressCard cage will look like the photo below.

(c) The MacBook Pro (17-inch Early 2008) ExpressCard cage will also have a piece of copper EMI shielding on the card cage where the Kapton tape is shown below.

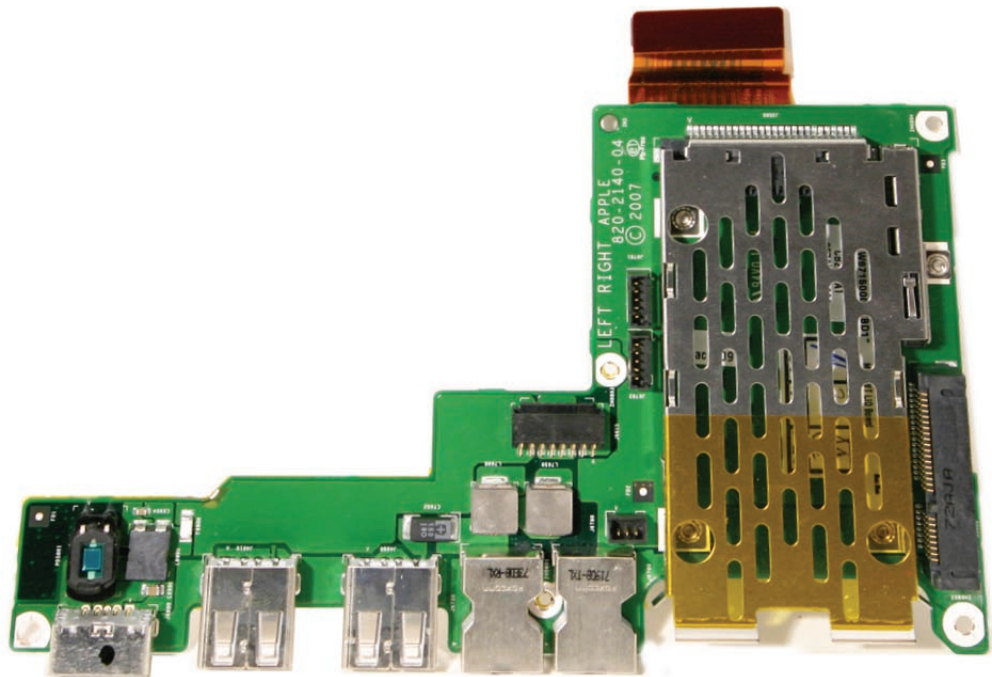

7. **Replacement Notes:**

- Transfer the any EMI gaskets from the former left I/O board.

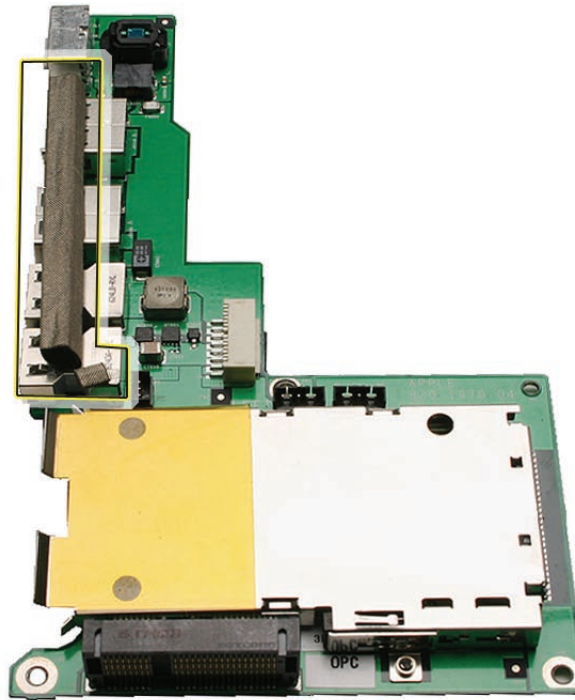

- Install the flex cable in the orientation shown.

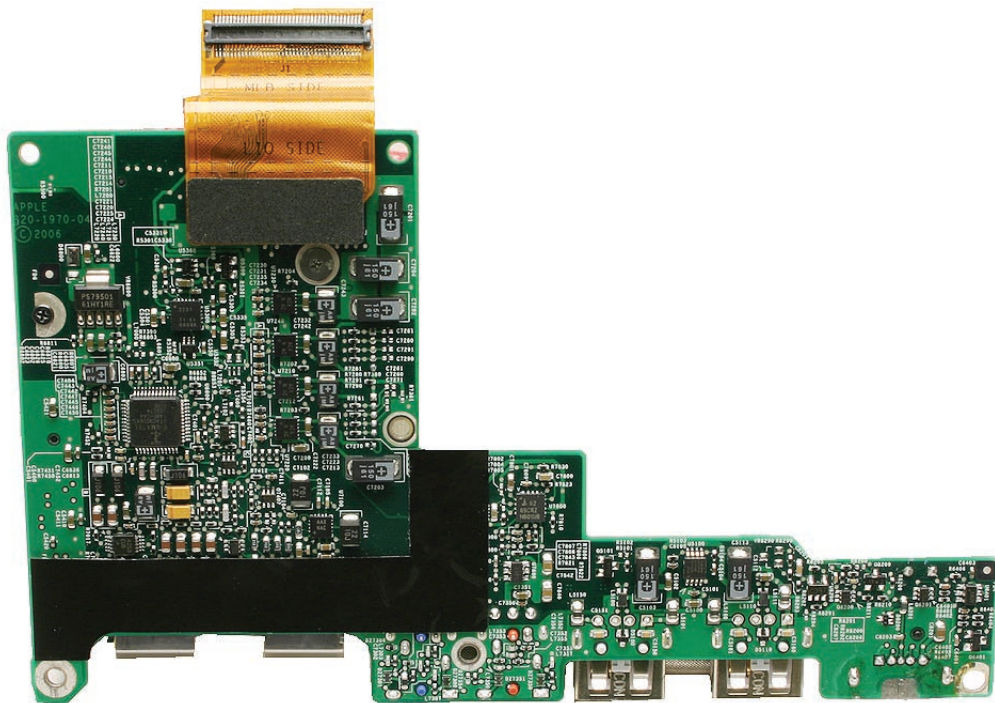

- When the board is in place and the ports are seated, hold the power adapter port tightly

against the port opening while installing screws.

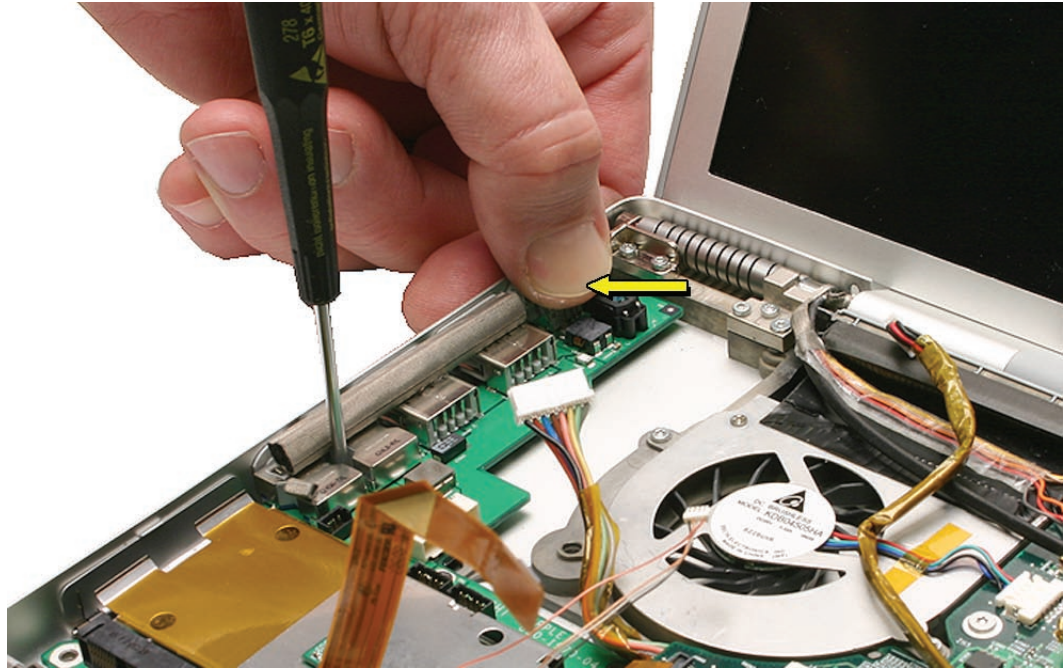

- After securing the board, exercise the ExpressCard slot door to verify clearance.



ExpressCard Cage

Tools

This procedure requires the following tools:

- #0 Phillips screwdriver (magnetized)

Preliminary Steps

Before you begin, remove the following:

- [Battery](#)
- [Top Case](#)
- [AirPort Extreme Card](#)
- [Left Speaker](#)
- [Left I/O Board](#)

Part Location

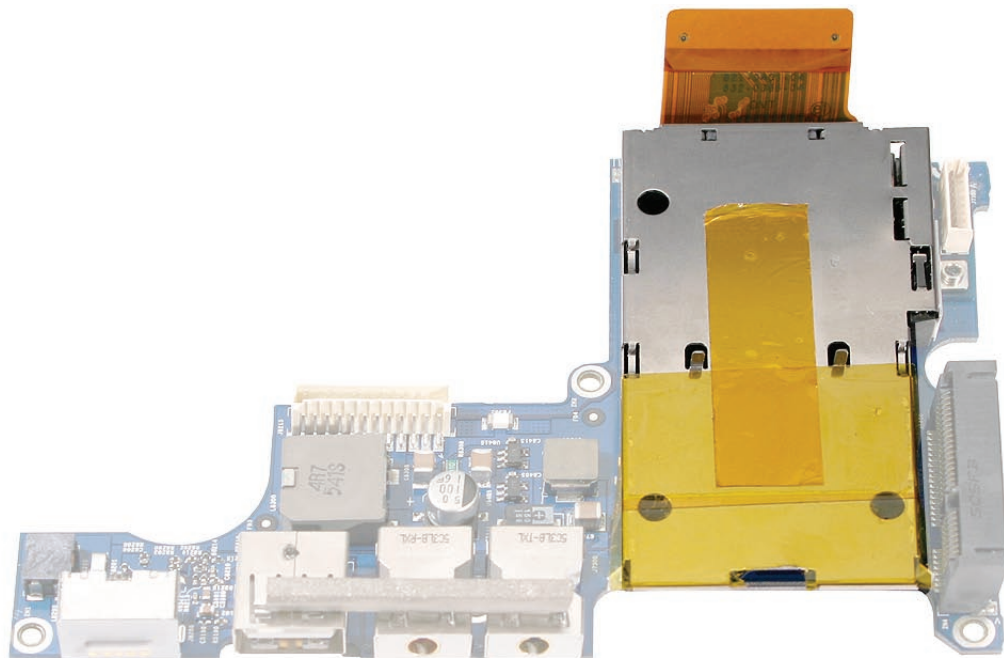

Procedure

See the Left I/O Board chapter for removal of the ExpressCard cage.



Fans

Tools

This procedure requires the following tools:

- Torx T6 screwdriver (magnetized)
- Black stick (nylon probe 922-5065) or other non-conductive nylon or plastic flat-blade tool
- Razor knife
- Kapton tape (922-1731) (0.5-inch x 12-yard roll)

Preliminary Steps

Before you begin, remove the following:

- [Battery](#)
- [Top Case](#)
- [Left Speaker](#) (left fan)

Part Location

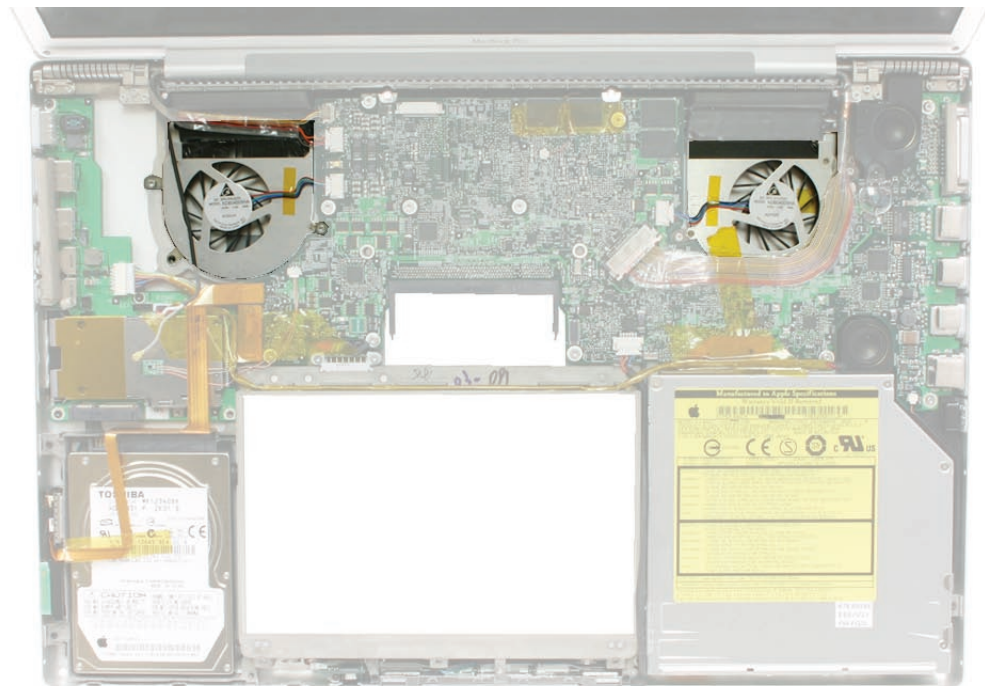

Procedure

To remove the left fan:

1. Disconnect the three connectors to the right of the fan, then carefully peel up the inverter/camera cable bundle and move safely out of the way. Note: unlike the photo, two connectors below are JST connectors on the MacBook Pro (17-inch Core 2 Duo, 2.4GHz and Early 2008).
2. **Note:** Use care to try not to dislodge the EMI gasket on the camera connector (see below).

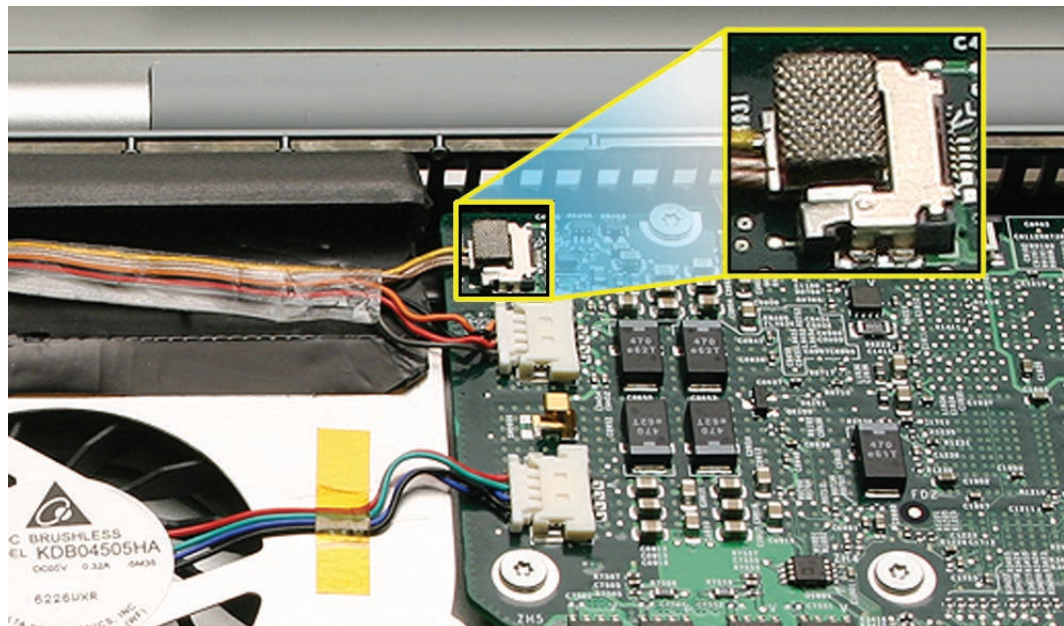
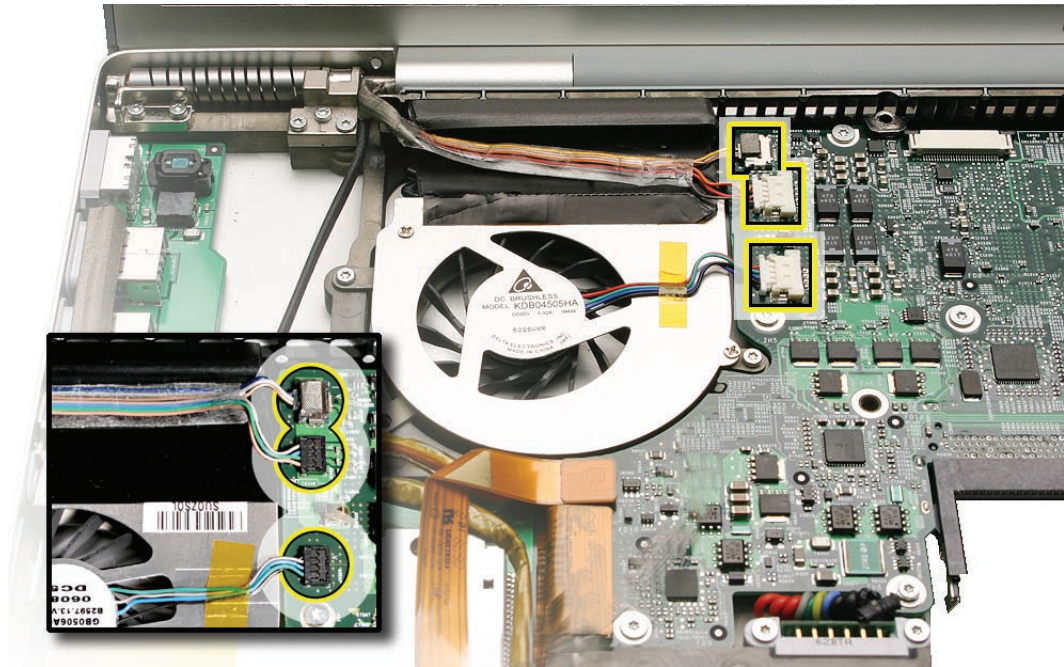

3. In the MacBook Pro (17-inch and 17-inch Core 2 Duo), with cables safely out of the way, use a razor knife to cut the length of the tape along the seam between the fan cover and the fins.

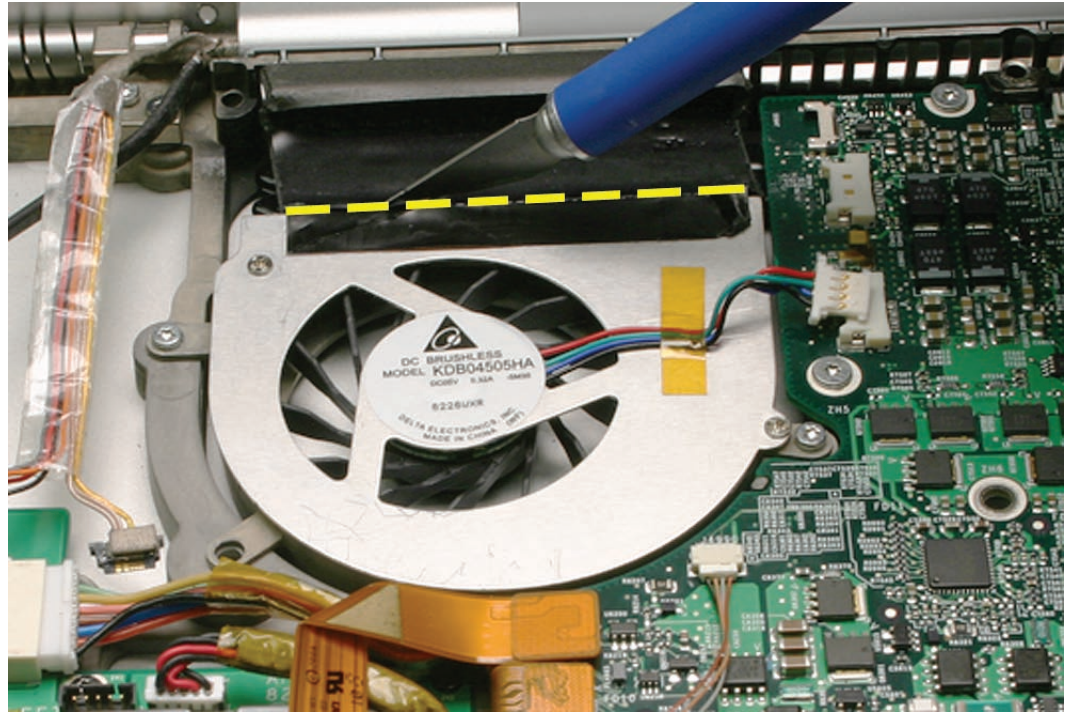

(b) In the MacBook Pro (17-inch 2.4GHz and Early 2008) there is no need to cut the tape. It will lift away from the heatsink without damage.

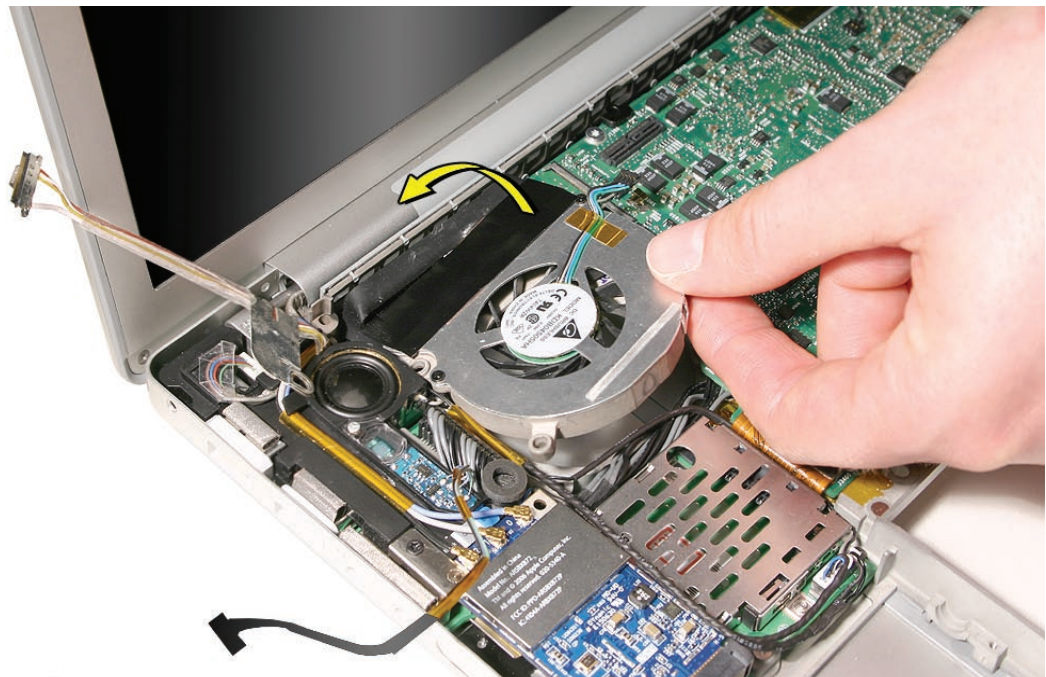

- 4.

5. Remove two Torx T6 screws.

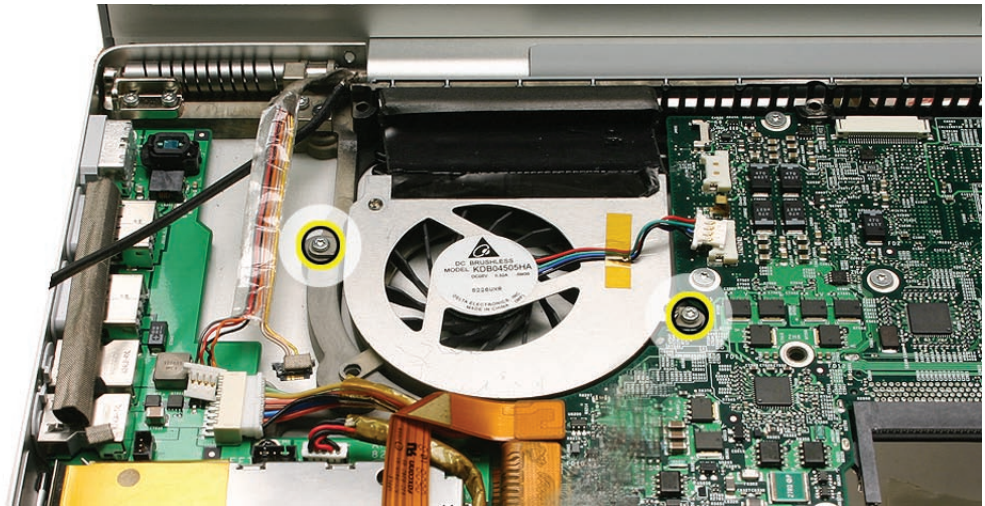

6. Lift the fan out.

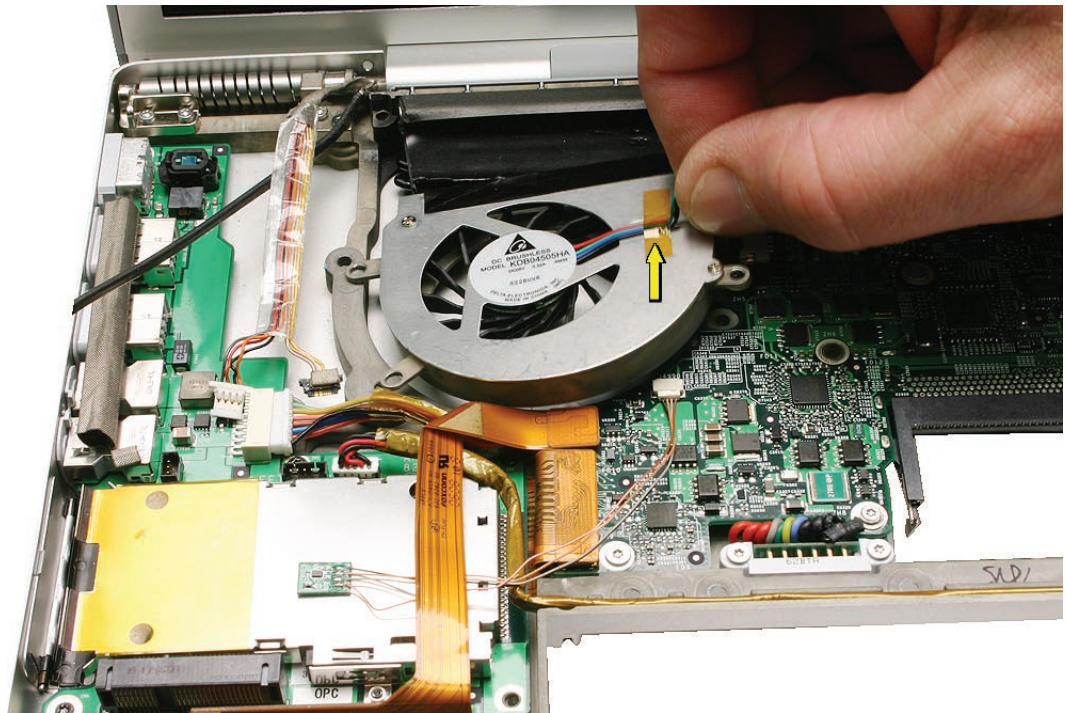

7. **Replacement Note:** If necessary, use Kapton tape to reseal the cut tape.

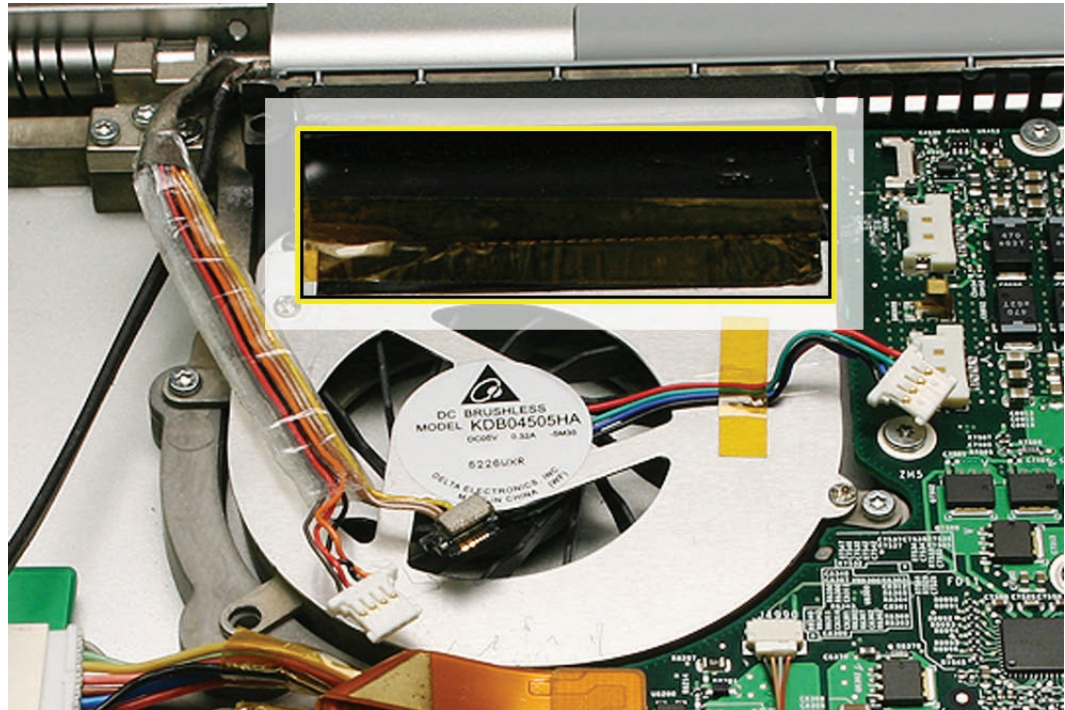

To remove the right fan:

1. Disconnect the LVDS cable and fan connector and move safely out of the way.

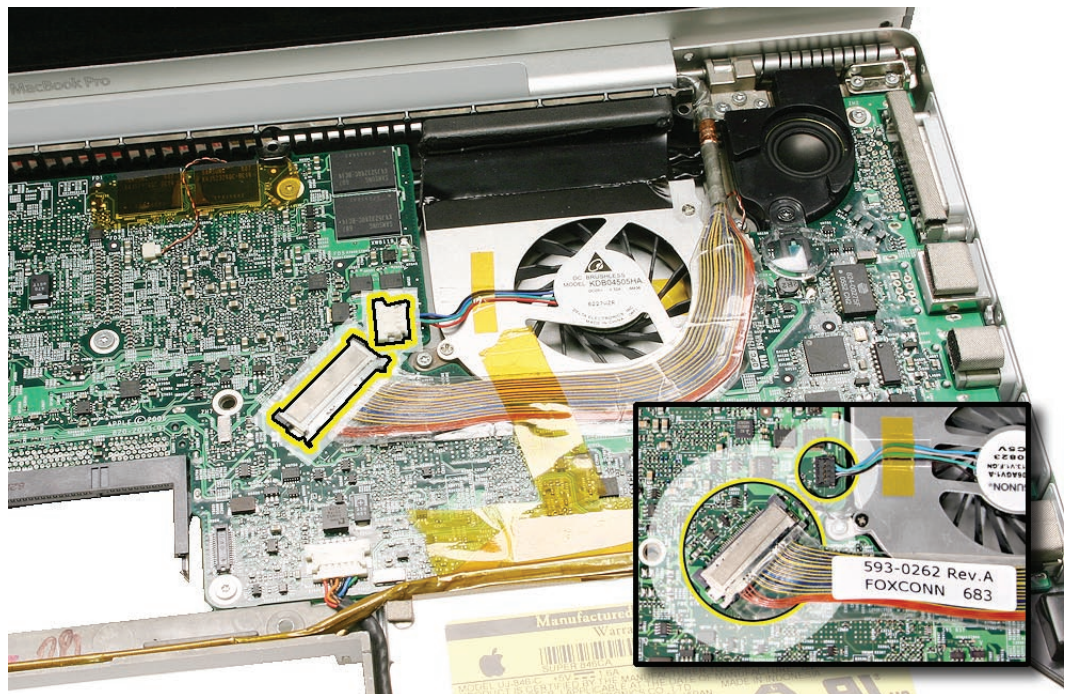

2. In the MacBook Pro (17-inch and 17-inch Core 2 Duo), use a razor knife to cut the length of the tape along the seam between the fan cover and the fins.

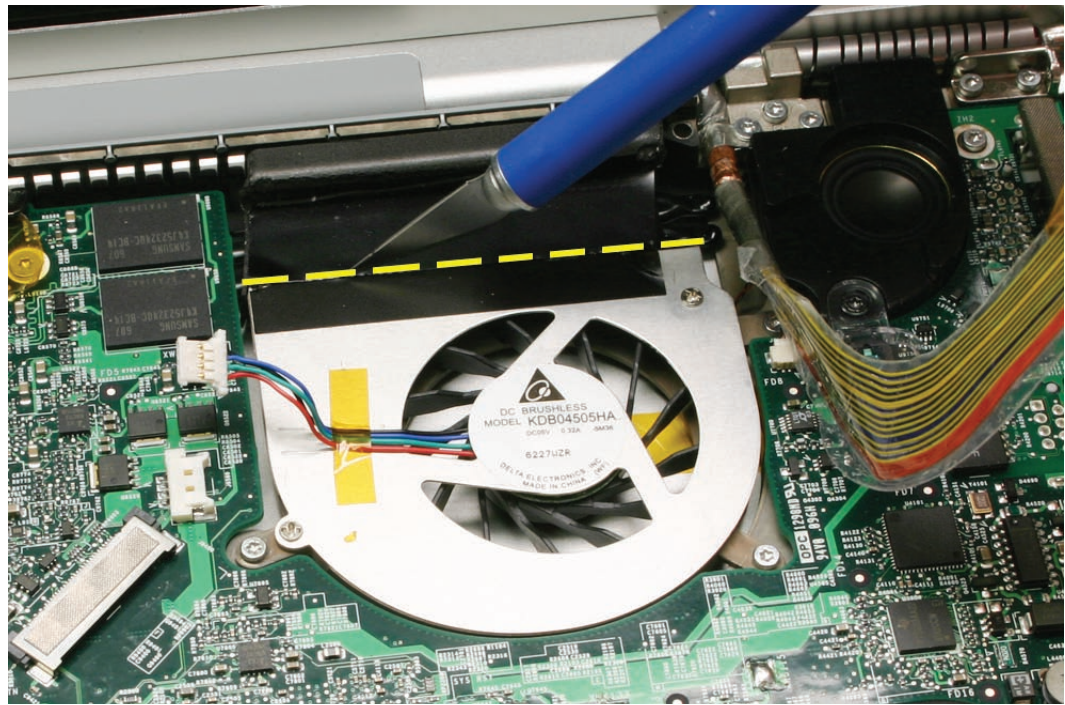

(b) In the MacBook Pro (17-inch 2.4GHz and Early 2008) there is no need to cut the tape. It will lift away from the heatsink without damage.



3. Remove three screws and lift the fan out.

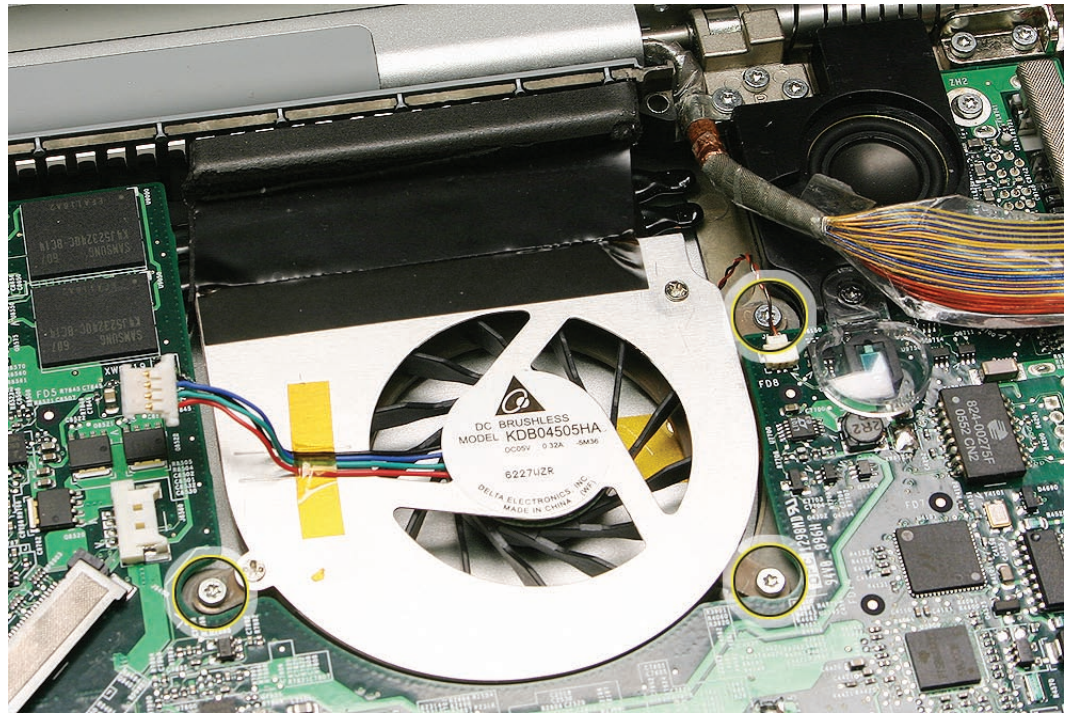

4. **Replacement Note:** If necessary, use Kapton tape to reseal the cut tape.

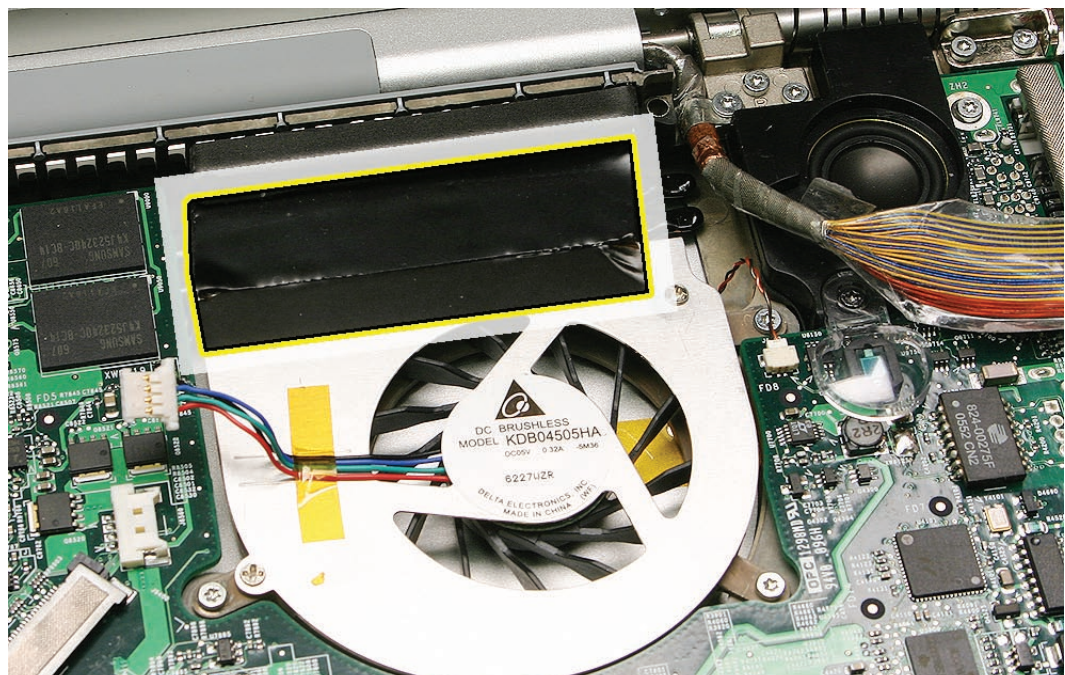



Logic Board

Tools

This procedure requires the following tools:

- Torx T6 screwdriver (magnetized)
- Black stick (nylon probe 922-5065) or other non-conductive nylon or plastic flat-blade tool
- Needle-point metal probe
- Multi-compartment screw tray (such as a plastic ice cube tray)
- Kapton tape (922-1731) (0.5-inch x 12-yard roll)
- Thermal grease (922-7144)
- Gasket kit (076-1217)
- Isopropyl alcohol cleaning wipes

Preliminary Steps

Before you begin, remove the following:

- [Battery](#)
- [Memory](#)
- [Top Case](#)
- [Left Speaker](#)
- [Optical Drive](#)

Part Location



Procedure

Note: Some photo details below may differ slightly from the model of 17-inch MacBook Pro you are repairing; however, the procedure itself remains consistent for any of the models.

There are two ways to remove the logic board:

Method 1: Separate the logic board from the heatsink, as usual, then reinstall thermal material when reinstalling.

Method 2: Keep the logic board together with the heatsink and fans, thus avoiding the need to replace thermal material.

If not replacing the logic board or heat sink, but removing the board to facilitate another procedure, such as replacing the right speaker or bottom case, then use method 2, if desired.

Warning: Allowing a logic board to flex, even slightly, can damage solder joints to components. To avoid flexing, hold the board vertically along the wide sides. Do not hold the board by the ends or by the narrow neck at the fan cutout, or horizontally, as the board's weight can cause flex.

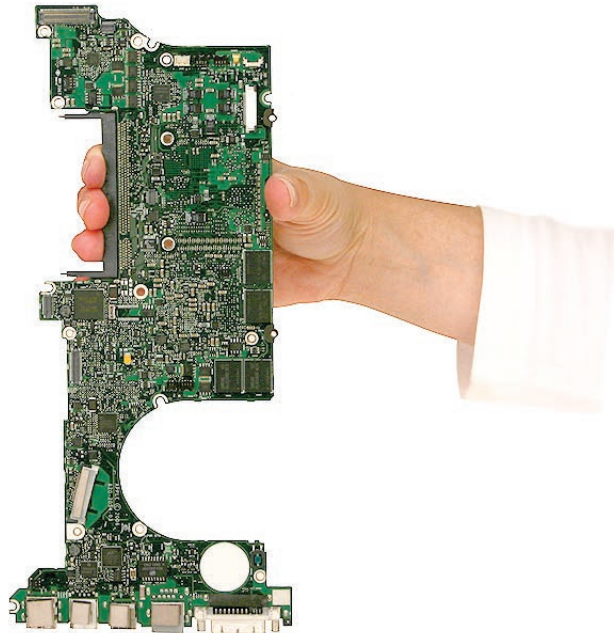

Method 1

Disconnect the twelve cables shown.

Note 1: For the MacBook Pro (17-inch original), use a needlepoint probe to disconnect the small thermal sensor and backup battery connectors from the logic board.

Warning: When using a needlepoint probe, great care must be used to avoid slipping off the connector and damaging components.

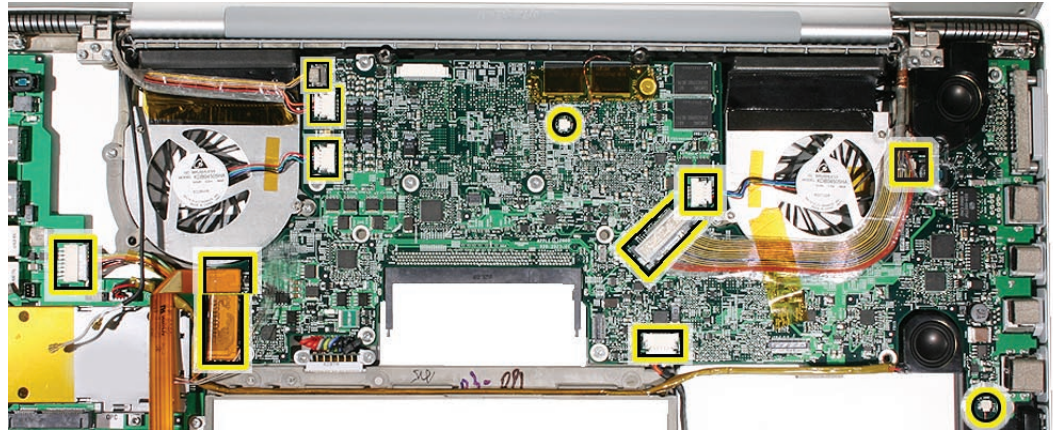

Note 2: For the MacBook Pro (17-inch Core 2 Duo, 2.4GHz and Early 2008), disconnect the JST connectors by sandwiching the connector between a finger or thumb on top and a black stick under the cable and as close to the JST connector as possible, gently pulling it straight up and out of its well.

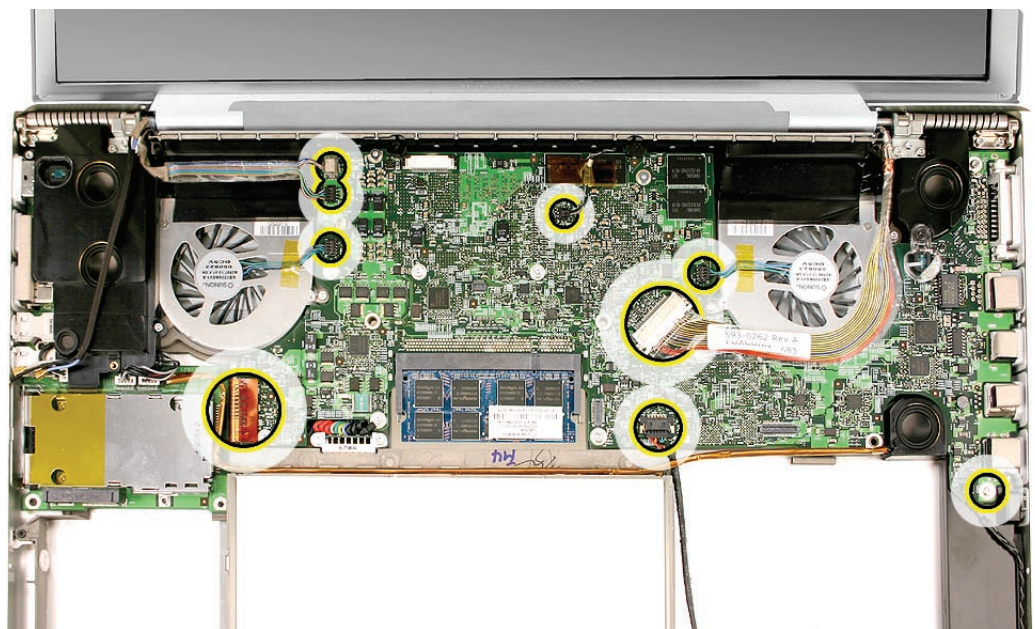

1. Tape the thermal sensor cable to the display assembly to avoid getting it trapped under the logic board and forgetting it during reassembly. **Important:** Do not tape over connectors with exposed contacts. Residual adhesive from the tape can contaminate the contacts.

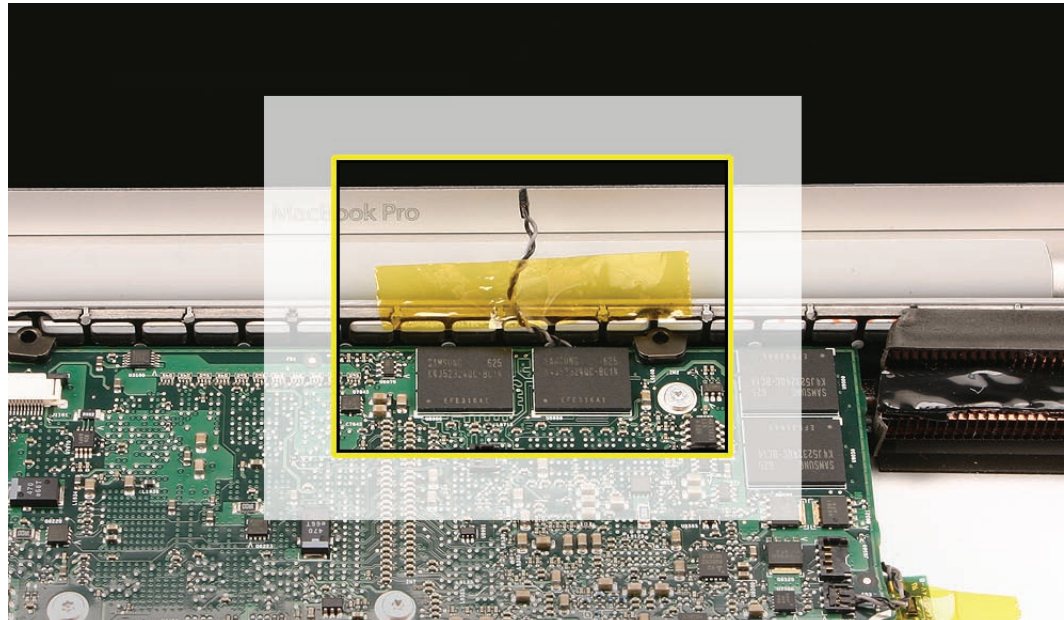

2. Remove the thirteen Torx T6 screws, shown.

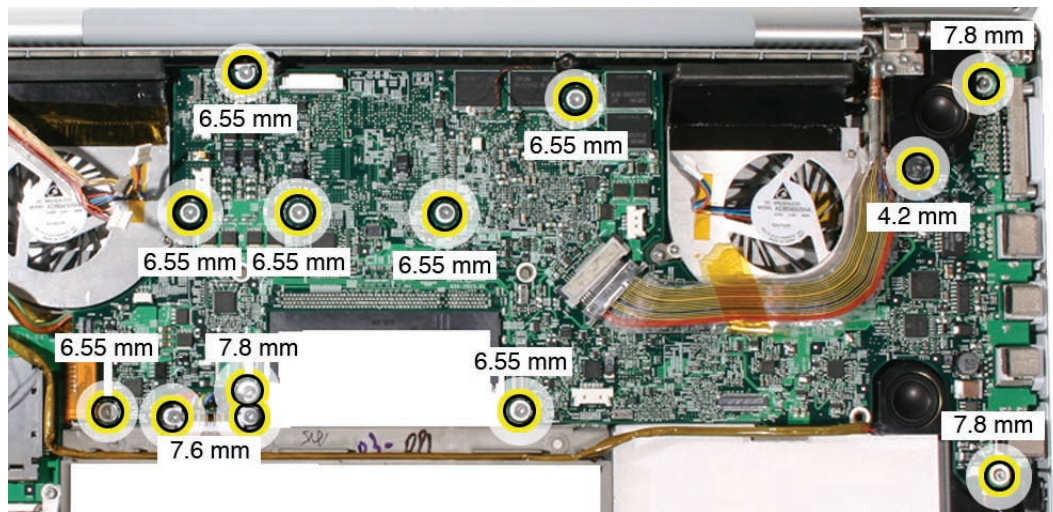
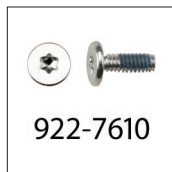

3. **Warning:** Do NOT allow the logic board to flex at any time. Flexing the board can crack solder joints to components. Give special attention at the narrow neck of the fan cutout.

4. From the left side of the board, slowly begin to lift the board, avoiding any flexing, until the thermal material on the three chips underneath releases.
Note: The thermal material should easily release. If not, verify that all screws and connectors have been removed



5. Be sure to insert the black stick between the logic board and the plastic shield on the bottom case below. Avoid lifting from under the plastic shield.

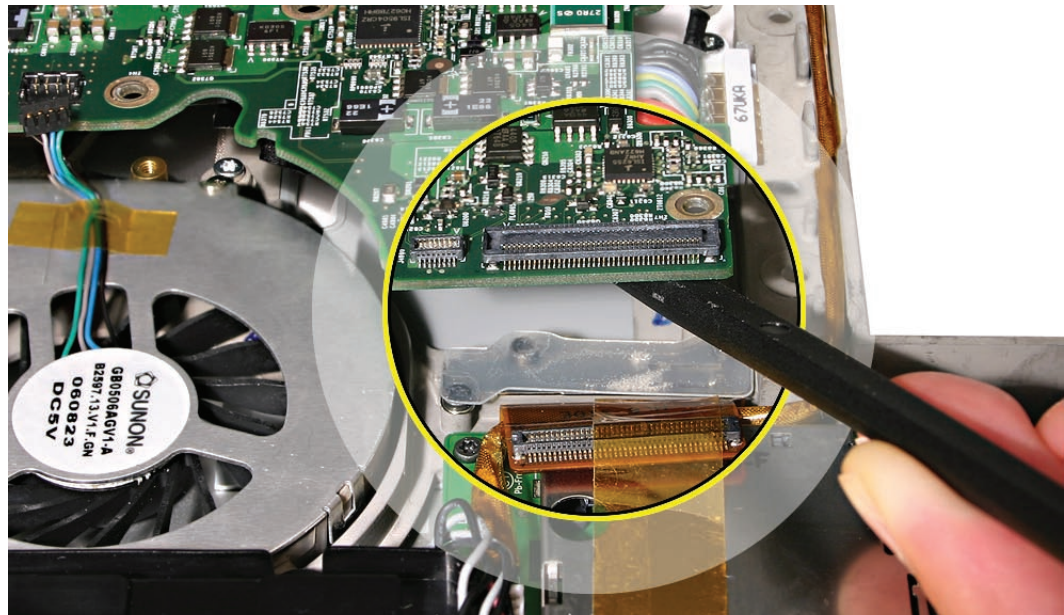

- Note the lip on the right speaker that overhangs the logic board. Be sure to lift the logic board with the speaker before separating to keep the logic board from bending.

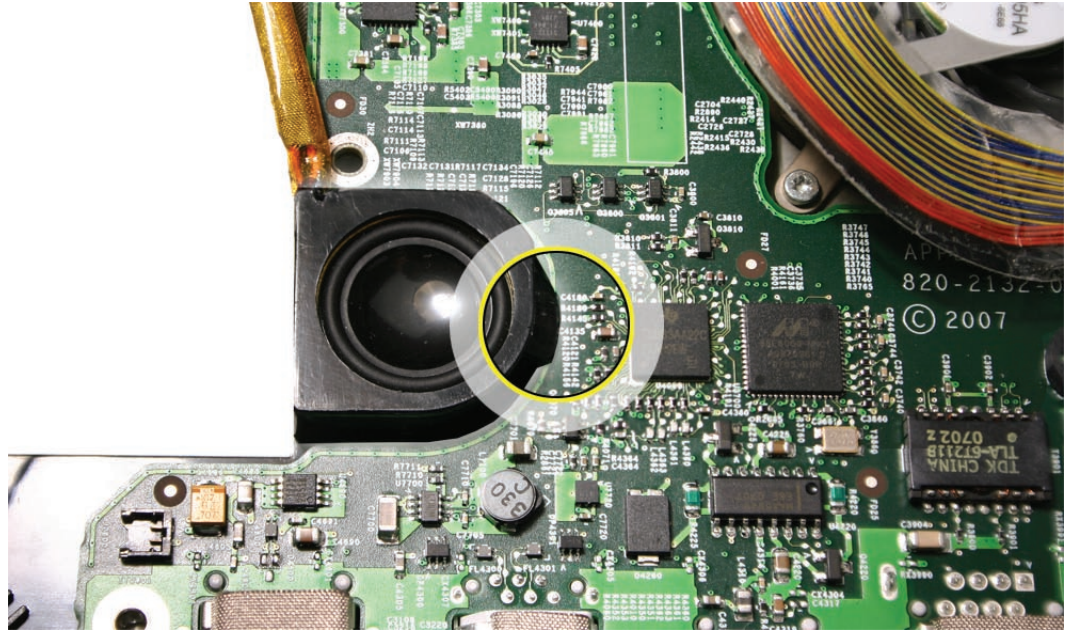

- Carefully lift the left side of the board, supporting the board along its sides as it lifts, and pivot along the ports side as you finesse it clear of the port openings..

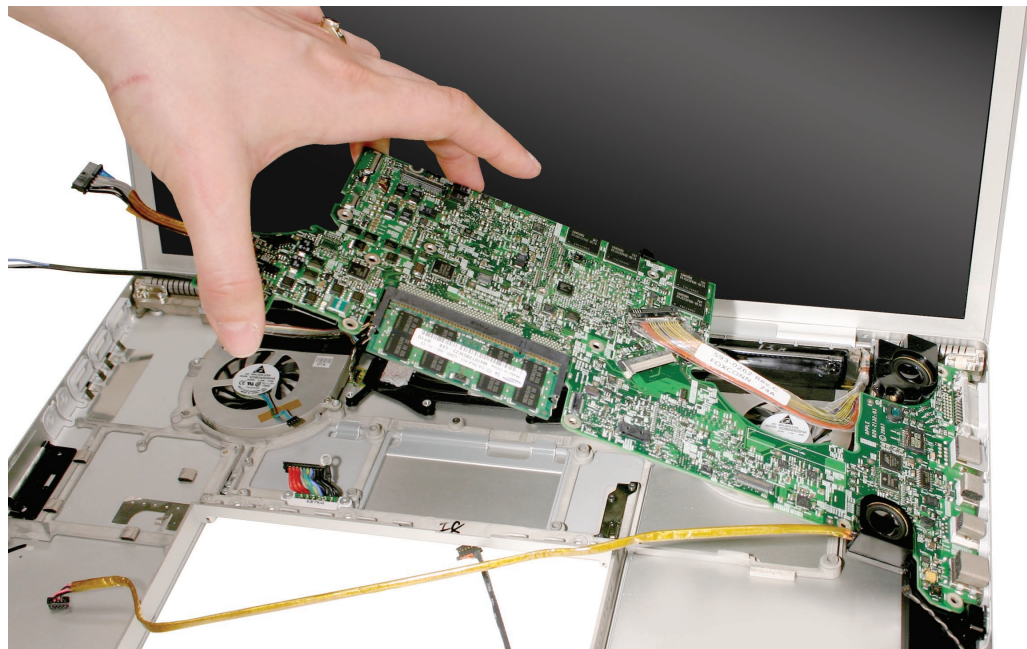

8. After lifting the logic board clear of the bottom case, separate the speaker from the logic board by sliding it directly down to clear the lip on the speaker enclosure.

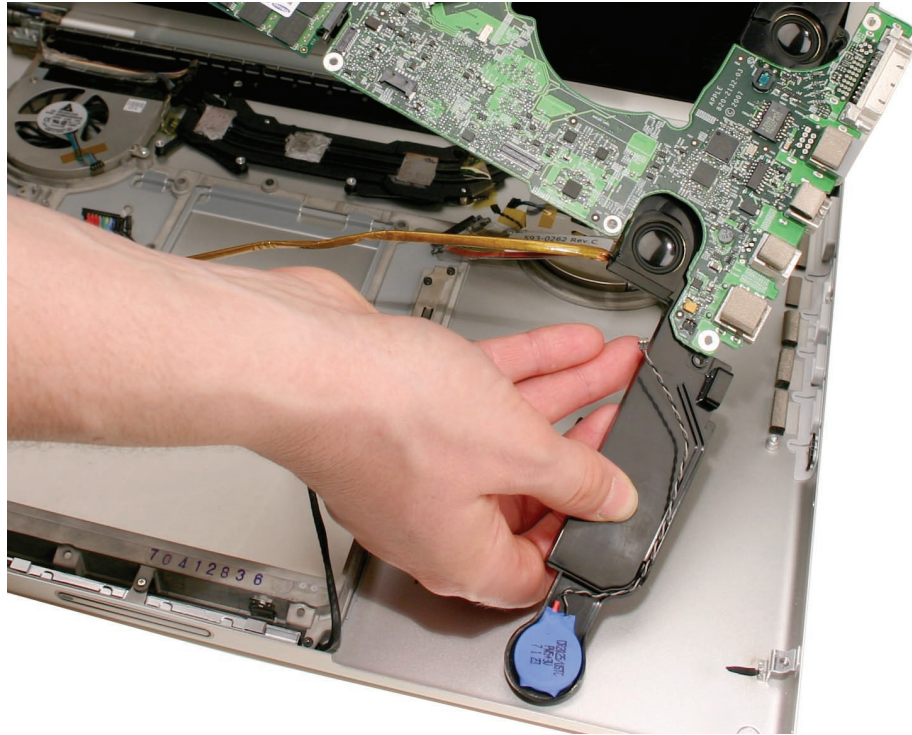

9. Remove the logic board.

Important: In the MacBook Pro (17-inch Core 2 Duo) only, there are two metal shims either on the *under* side of the logic board or on the heatsink heatpipes near the graphics chip (see location callouts below). If reusing this logic board, make sure those shims retain their position above the heat sink posts.

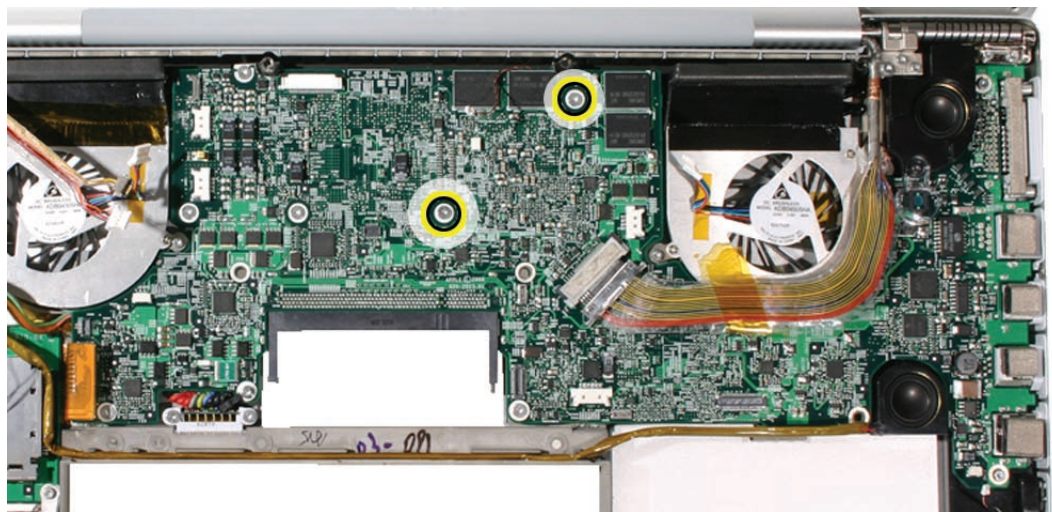

Method 2

1. Disconnect the ten cables shown. (Note: some of the cable connectors in the MacBook Pro (17-inch Core 2 Duo, 2.4GHz and Early 2008) may be JST connectors, not pictured below.)

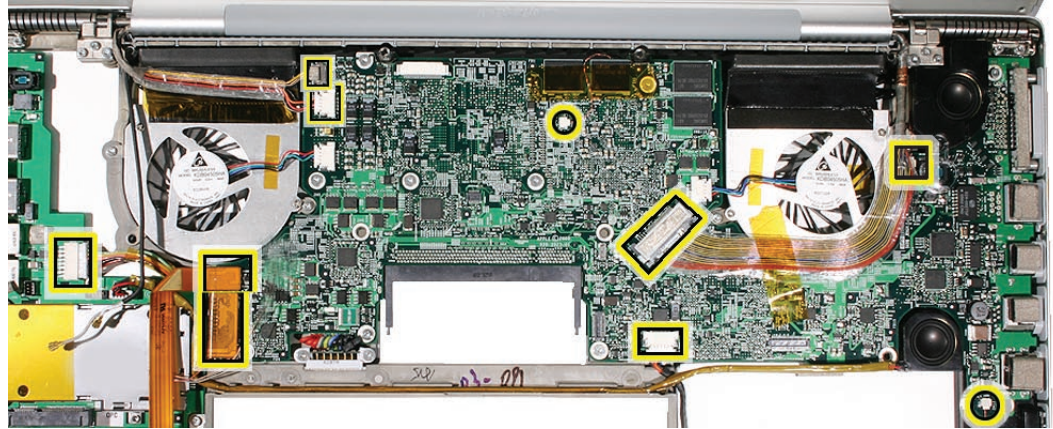

2. Tape the thermal sensor cable to the display assembly to avoid getting it trapped under the logic board and forgetting it during reassembly. **Important:** Do not tape over connectors with exposed contacts. Residual adhesive from the tape can contaminate the contacts.

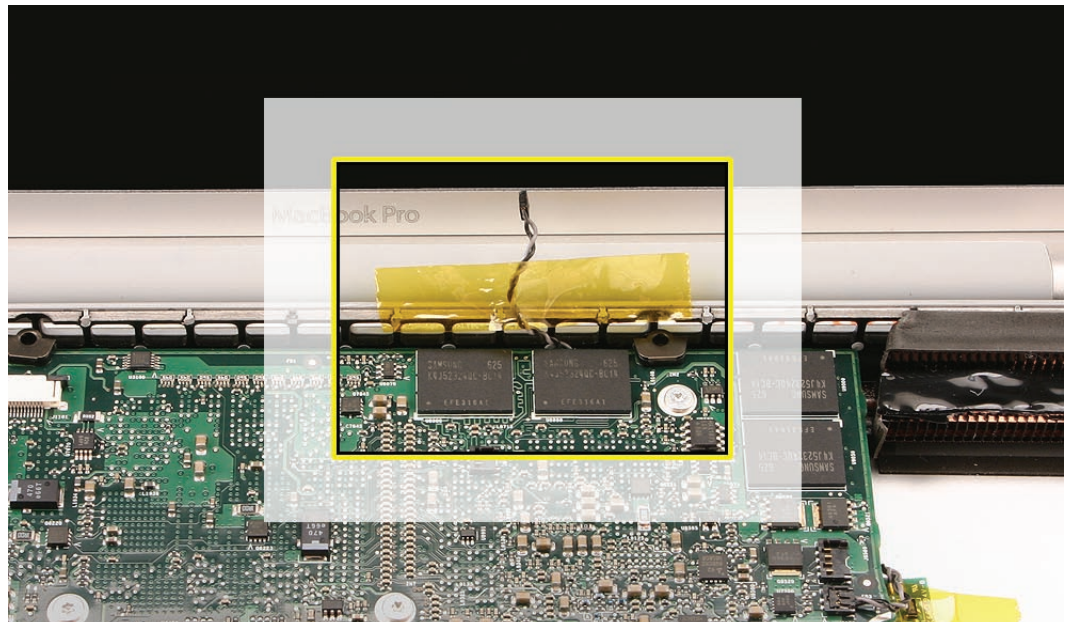

3. Remove the twelve Torx T6 screws, shown. Two screws that secure the fan to the frame are indicated below under the LVDS cable.

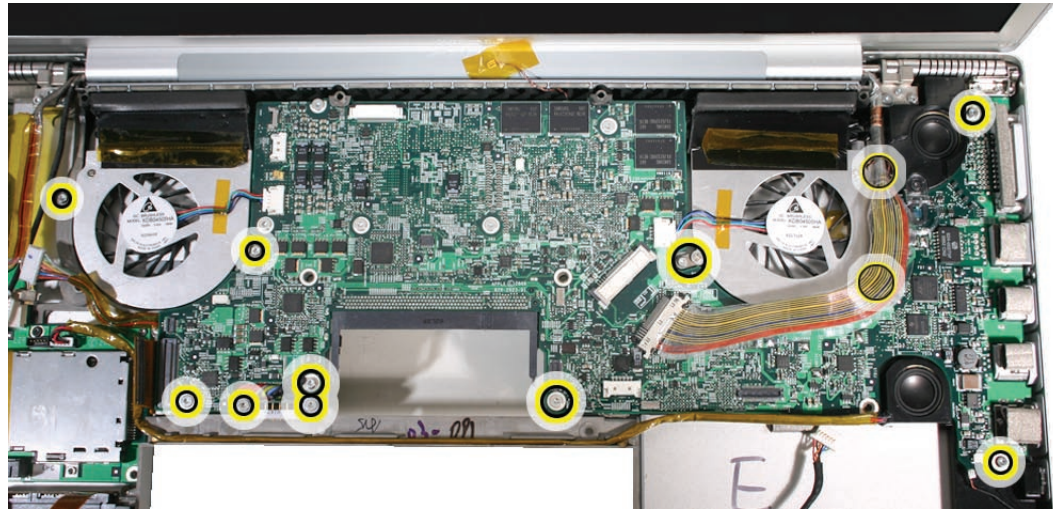

4. **Warning: Do NOT allow the logic board to flex at any time. Flexing the board can crack solder joints to components. Give special attention at the narrow neck of the fan cutout.**
5. Use a black stick under the extension of the heatsink, just below the rear of the left fan, then slowly begin to lift the board, avoiding any flexing.
Note: The the logic board and heatsink assembly, along with the fans, should easily lift up. If not, verify that all the appropriate screws and connectors have been removed.

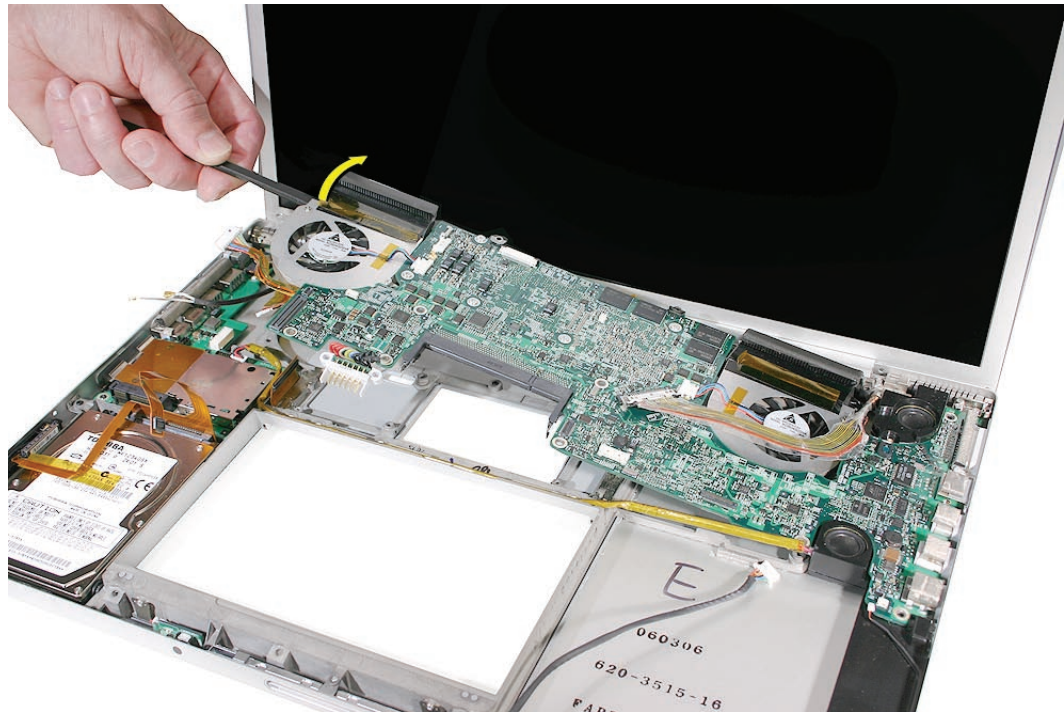

- Note the lip on the right speaker that overhangs the logic board. Be sure to lift the assembly with the speaker before separating to keep the logic board from bending.

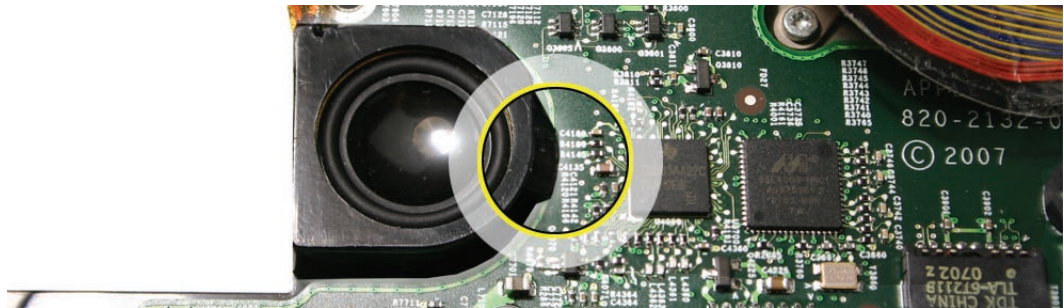

- Support the assembly as it lifts, and pivot up and away from the ports as you finesse it clear of the port openings. (Unlike the photo below, keep the speaker attached to the assembly.)



- After lifting the logic board clear of the bottom case, separate the speaker from the logic board by sliding it directly down to clear the lip on the speaker enclosure. Remove assembly.

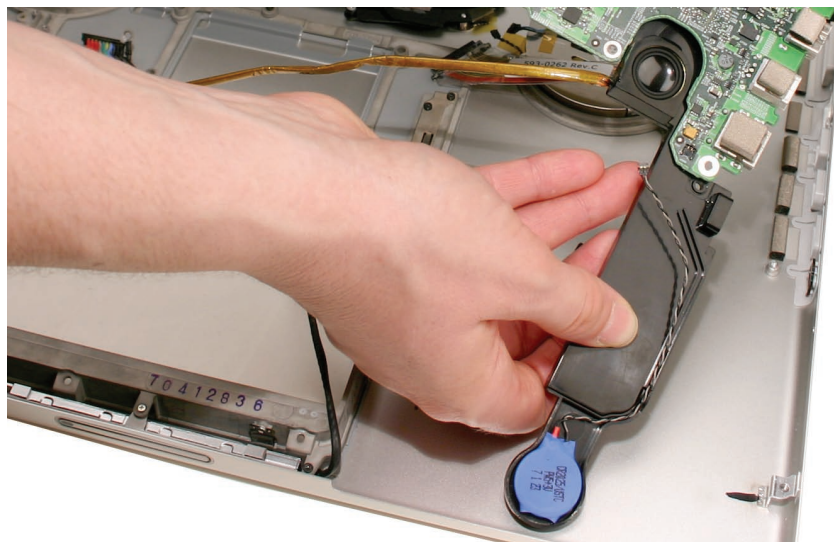

Replacement Procedure

1. Verify that the EMI gaskets are in place along the port openings on the bottom case.

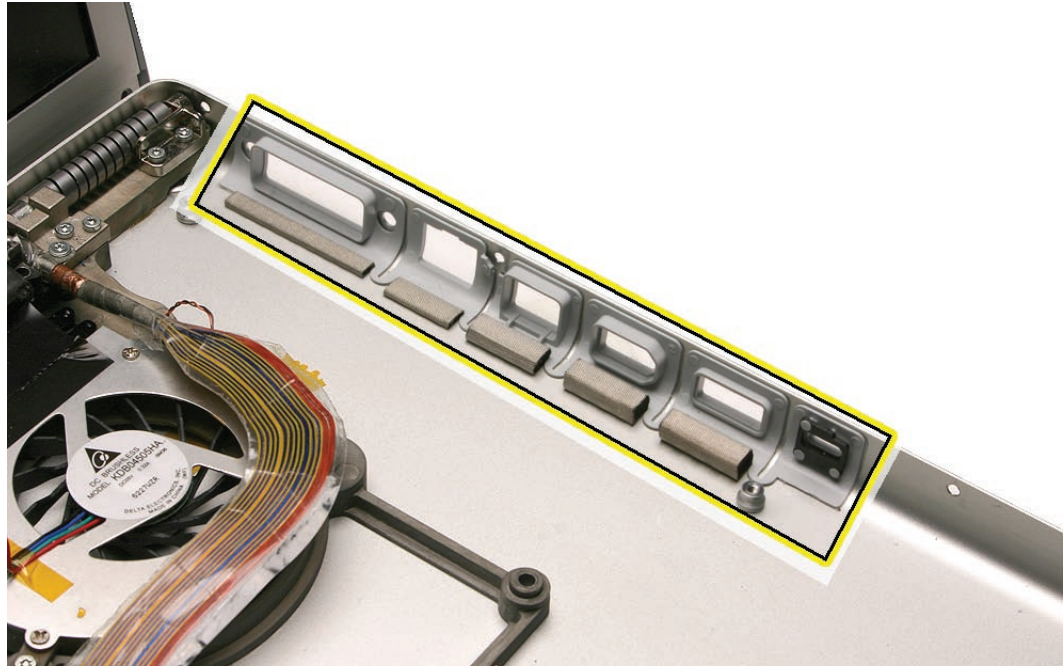

2. If replacing the logic board, transfer the two screw guides, called sleeves, along top edge of the board.

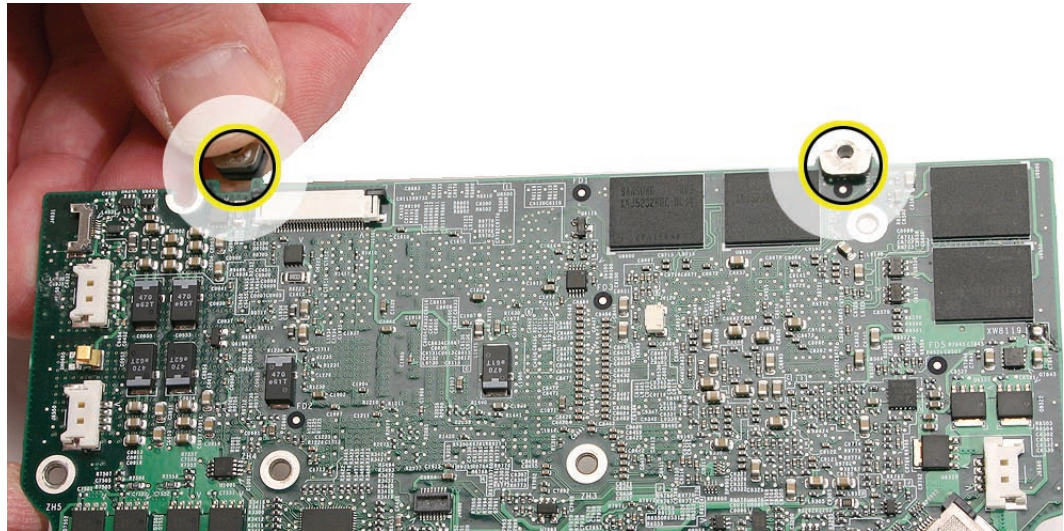

Important: There are two metal shims on the *under* side of the logic board near the graphics chip. (See screws #4 and #5 in the screw replacement order in step 14, following.) Make sure those shims retain their position above the heat sink posts when replacing.

3. **Warning:** If the logic board was removed to facilitate another procedure and will be reinstalled, the existing thermal grease cannot be left on the board and must be completely cleaned off, since it will create a thermal barrier if combined with new grease. Use the following procedures to clean off the old thermal grease—or overheating and damage can result.
4. Use a black stick to remove the grease from the mating surfaces of the three chips.
Important: Use extreme care not to damage the chips or logic board components.
5. Use alcohol wipes to completely clean the grease from the surfaces and surrounding area.

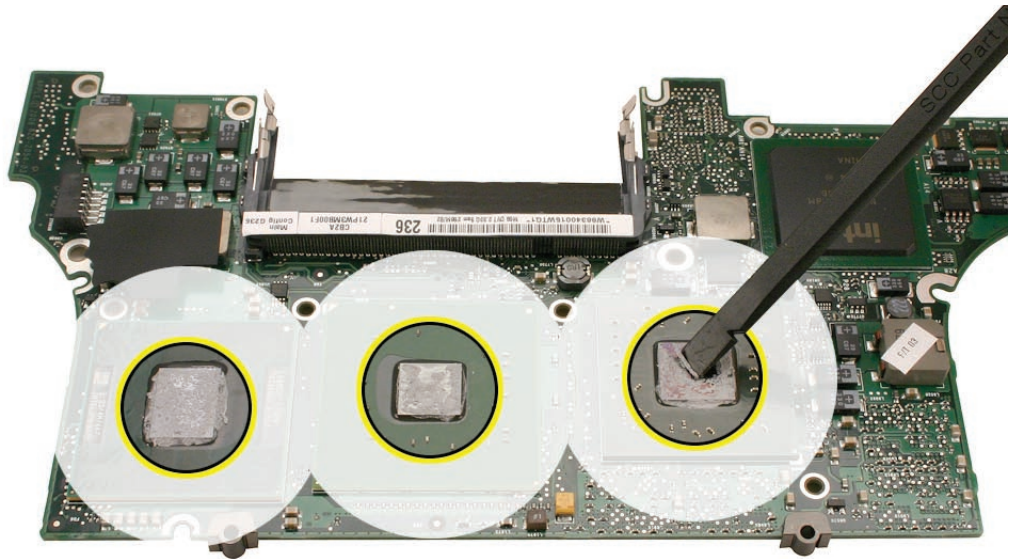

- Install EMI gaskets and tape on the ports from the gasket kit.

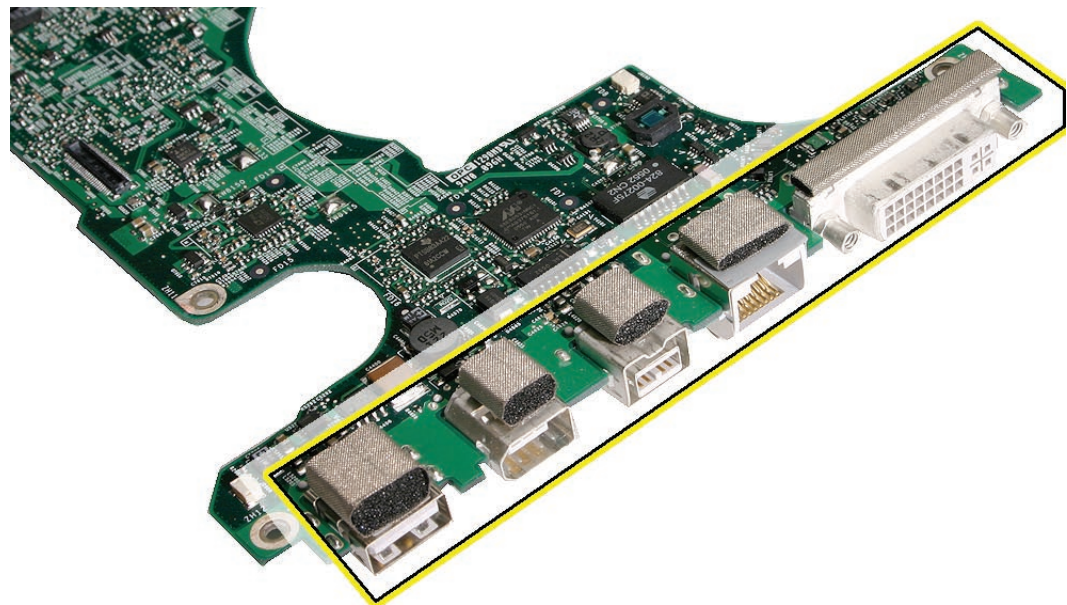

- Transfer the cosmetic shield, if needed.
- Transfer the battery cable and the left I/O board cable

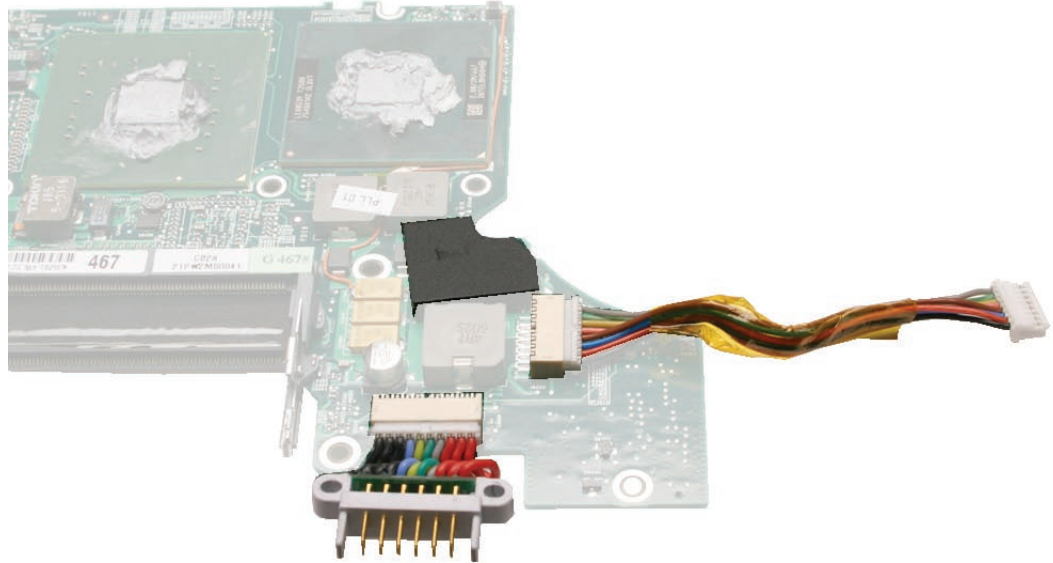

Warning: Used/existing thermal grease cannot be reused and must be completely cleaned off, since it will create a thermal barrier if combined with new grease.

Use the following procedures to clean off the old thermal grease, and then to reinstall new thermal grease—or overheating and damage can result.

6. Use a black stick to remove the thermal grease from the three mating surfaces.
7. Use alcohol wipes to completely clean the grease from the surfaces and surrounding area.

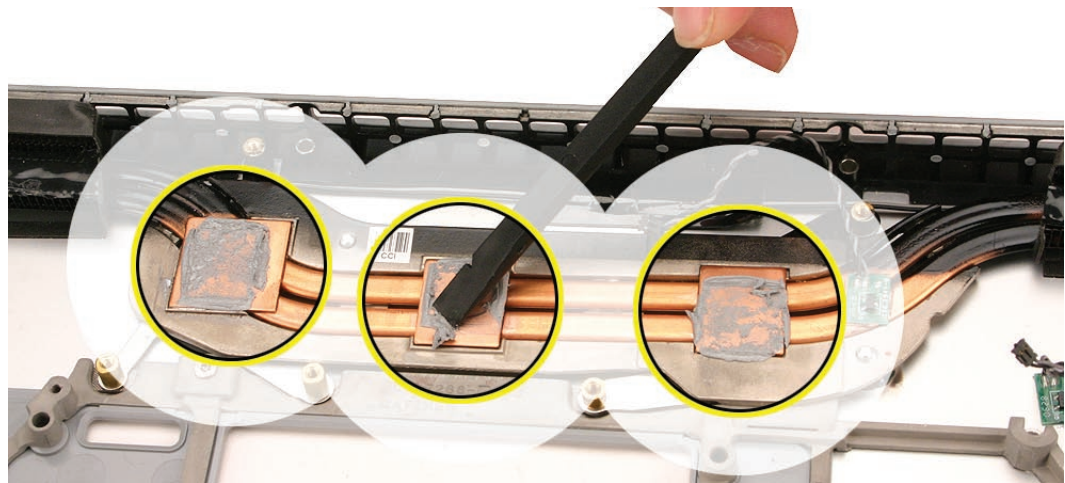

Warning: Whenever the logic board is separated from the heatsink, the thermal grease must

be replaced. Failure to do so can cause the computer to overheat and be damaged.

Important: Avoid unnecessary contact with new thermal material, as dirt and body oils reduce the material's conductivity.

8. Note the contents of the syringe of thermal grease. **Important:** One syringe (922-7144) contains 0.3 to 0.35 cubic centimeters (cc) of thermal grease. That is enough for 0.1 to 0.12 cc of grease per chip for up to three chips. Use one-third of the syringe contents per chip. Using a felt-tip pen, mark the 1/3 points on the syringe before applying the first dab. .



9. Put a 0.1 - 0.12cc dab of thermal grease, in the center, on each chip mating surface, as shown.

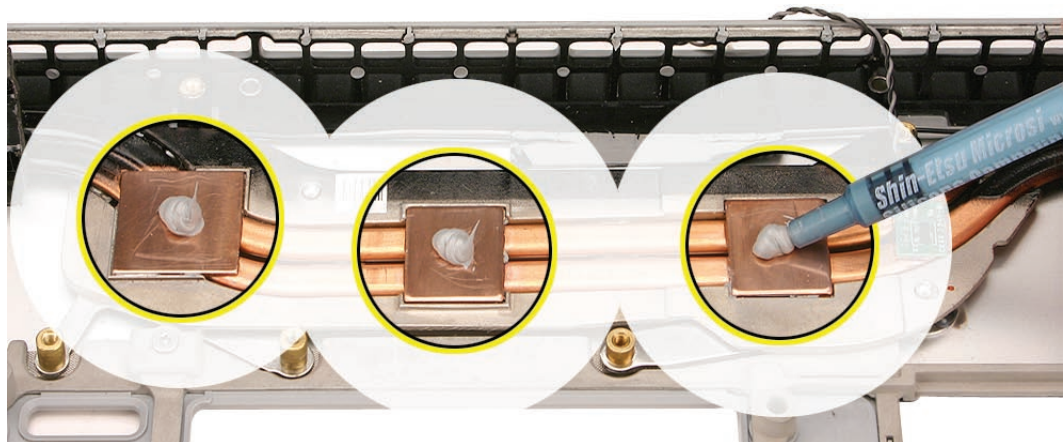

10. When replacing the logic board:
 - Verify that the right speaker chamber is installed.
 - Verify that the two screw guide "sleeves" are installed on the top of the board.
 - Guide the logic board's port side into the port openings on the bottom case.
 - Verify that no cables are caught under the board when lowering into place.
 - **Important:** Check for two metal shims on the under side of the logic board near the graphics chip. Make sure those shims retain their position when replacing.

11. To insure that the logic board sits flat, tuck the lower right edge of the logic board under the ridge just above the lower speaker driver on the right speaker (as shown below).

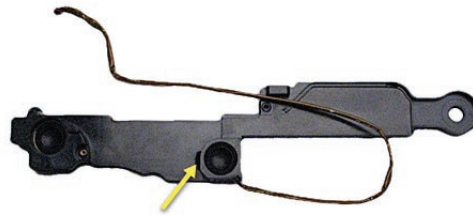

12. Tuck the battery cable under the frame as the board goes into place.

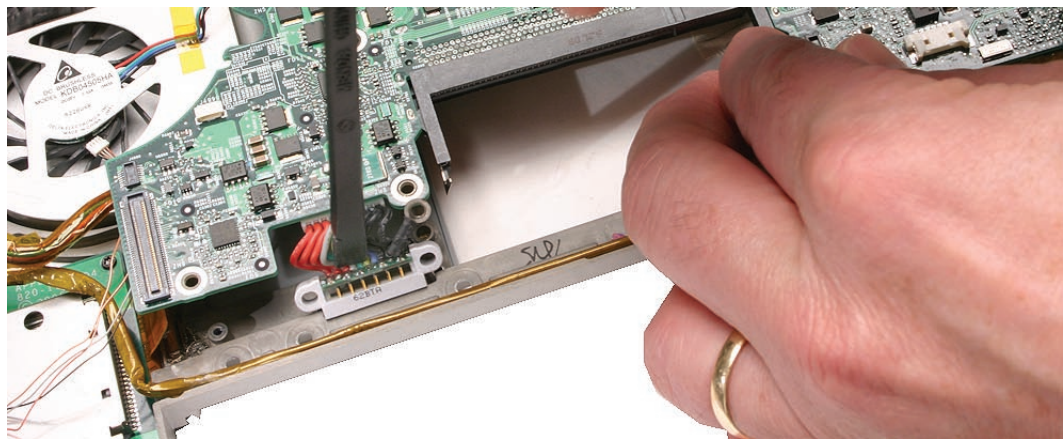

13. Verify, at the check points below, that no cables are caught under the board and that the screw sleeves are installed.

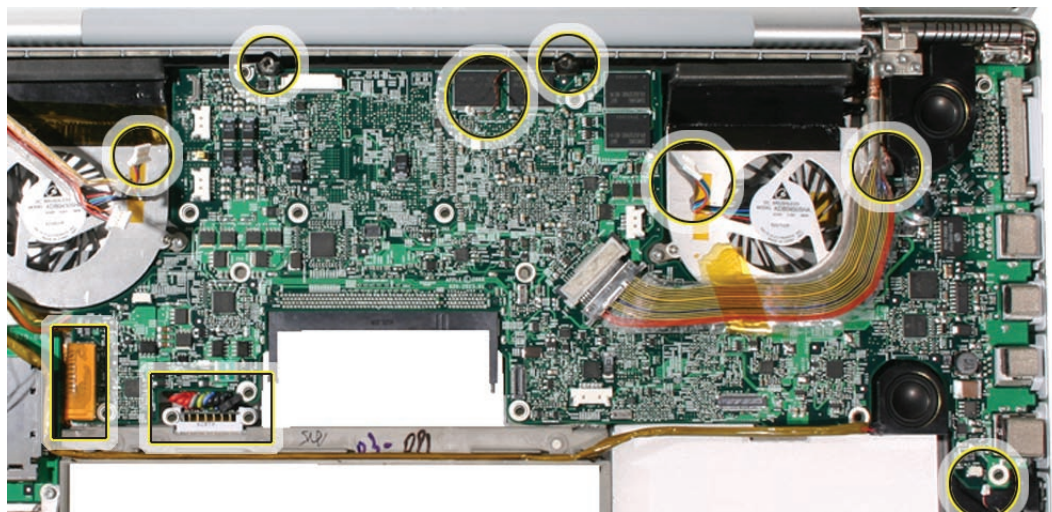

14. Attach the logic board screws in the order show below, including the screw for the right ALS dust cover and the two shoulder screws for the battery cable assembly.

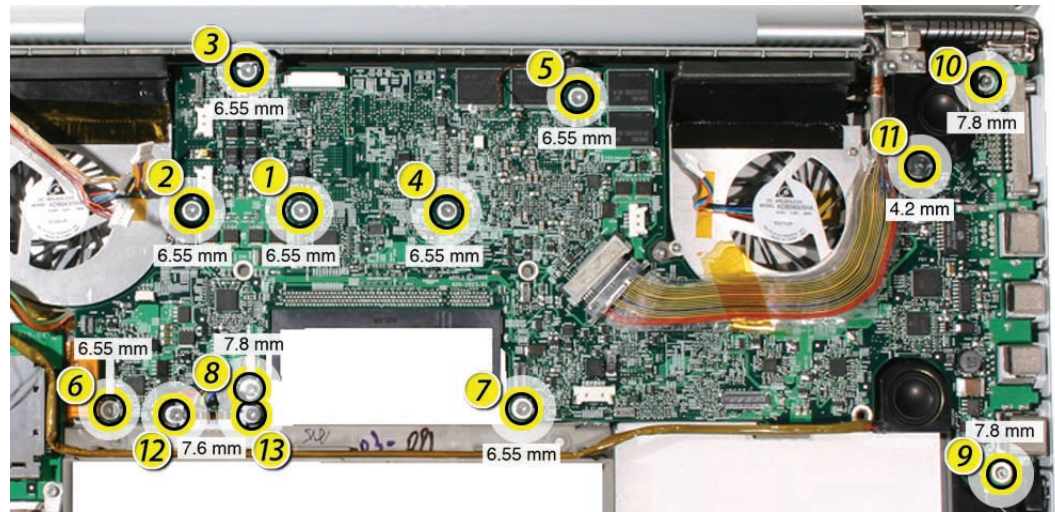

15. Verify that the battery cable ground strap is secured by the screw, as shown.

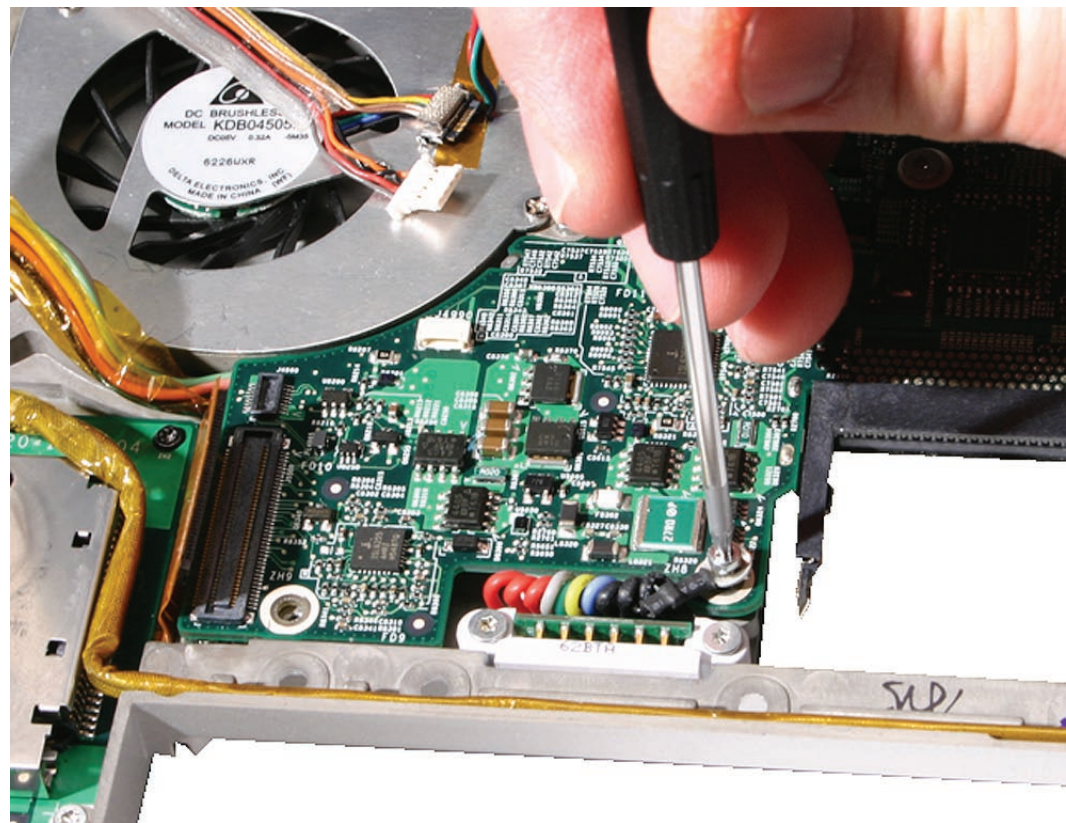

16. Verify that the EMI gasket is on the camera cable connector.

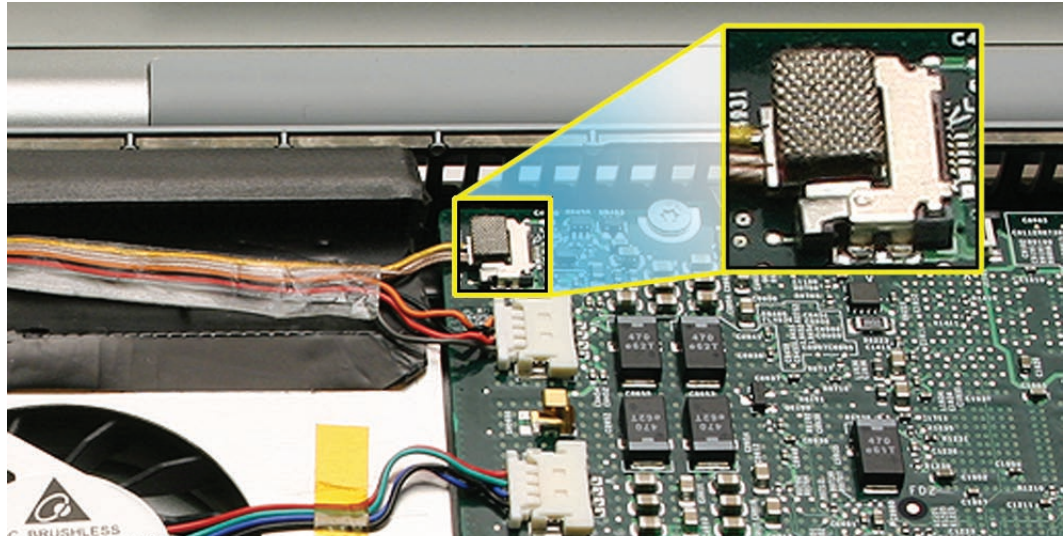

17. Verify that the ExpressCard cage flex connector, from the left I/O board, is seated properly all along the connector. If the connector on the flex is not lined up with the connector on the logic board, a bad connection with a characteristic bow can occur.

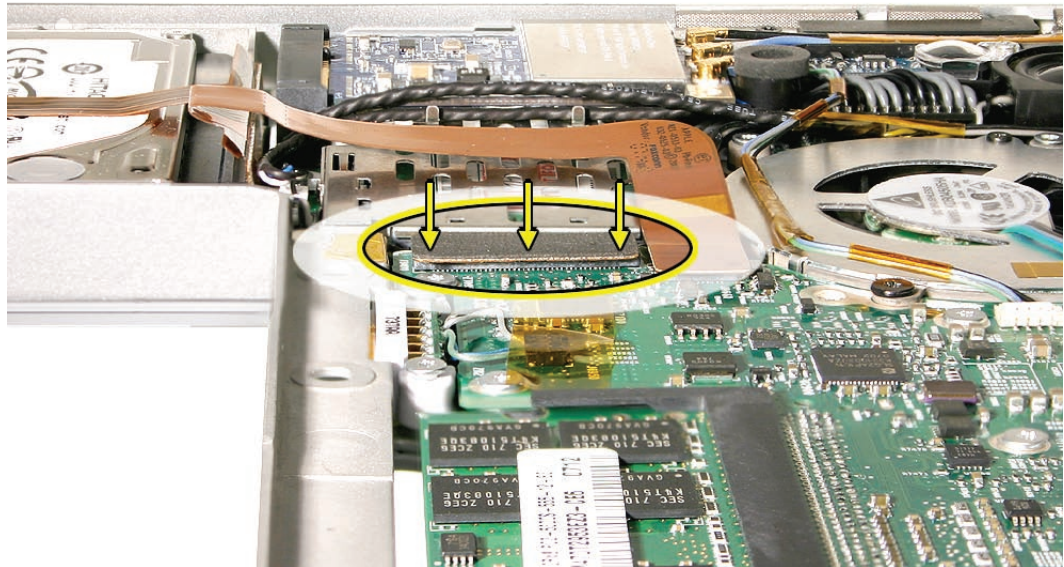

18. Reassemble and test all ports, components and functions of the computer.

Note: After installing new thermal grease, if you must briefly re-separate the logic board from the heatsink, it is acceptable to retain the same, new thermal grease, as long as it is not handled excessively.



Battery Cable Assembly

Tools

This procedure requires the following tools:

- Black stick (nylon probe 922-5065) or other non-conductive nylon or plastic flat-blade tool

Preliminary Steps

Before you begin, remove the following:

- [Battery](#)
- [Top Case](#)
- [Logic Board](#)

Part Location

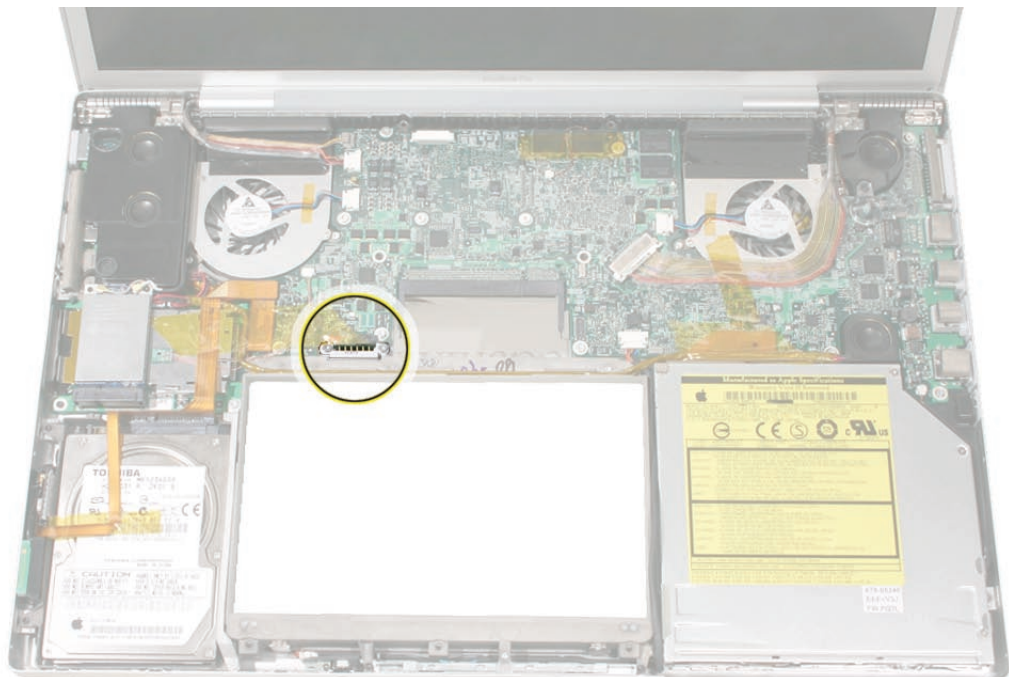

Procedure

1. Disconnect the cable from the bottom of the logic board.

Note: Two shoulder screws mount the battery cable to the bottom case but are removed during the logic board takeapart procedure..

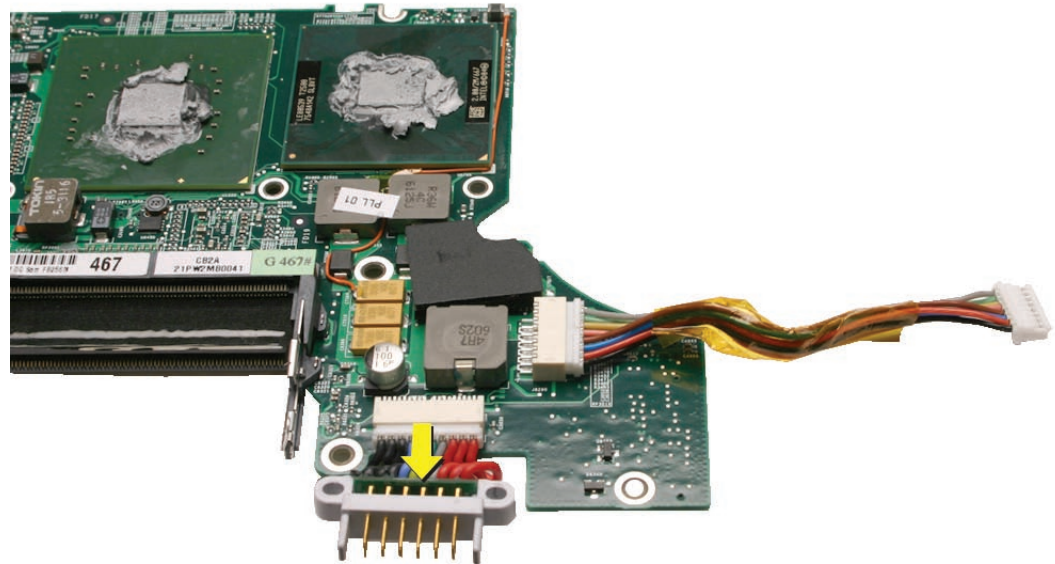



Thermal Sensors

Important: There are two thermal sensors, each requiring precise placement. One sensor is attached to the bottom case and one to the heatsink—they are NOT interchangeable.

Tools

This procedure requires the following tools:

- Fine-point felt-tip permanent marker
- Razor knife
- Needle-point metal probe
- Kapton tape (922-1731) (0.5-inch x 12-yard roll)
- Black stick (nylon probe 922-5065) or other non-conductive nylon or plastic flat-blade tool

Preliminary Steps

Before you begin, remove the following:

- [Battery](#)
- [Top Case](#)
- [Right Fan](#) (for bottom case sensor)
- [Logic Board](#) (for heatsink sensor)

Heatsink Sensor Locations

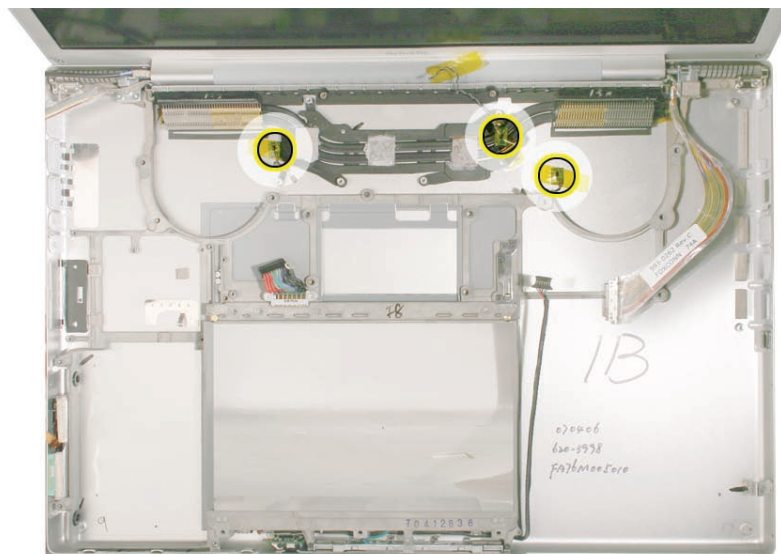

Bottom Case Sensor Location: MacBook Pro (17-inch)

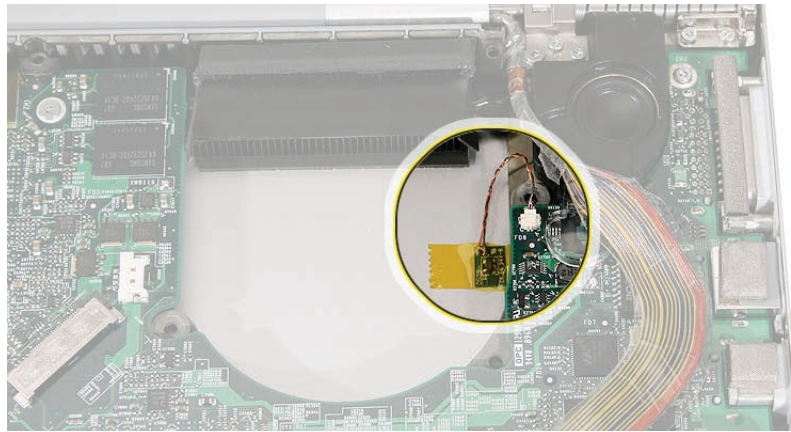

Bottom Case Sensor Location: MacBook Pro (17-inch Core 2 Duo)

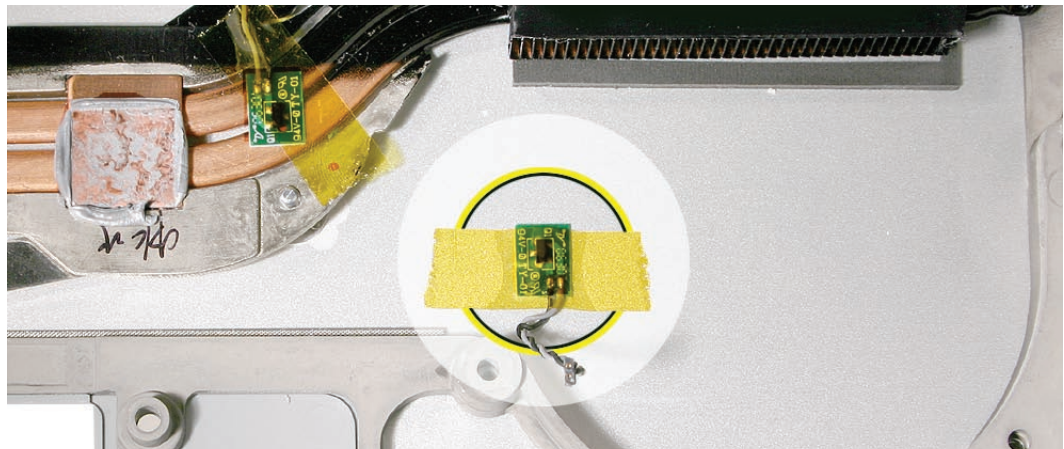

Bottom Case Sensor Locations: MacBook Pro (17-inch 2.4GHz and Early 2008)

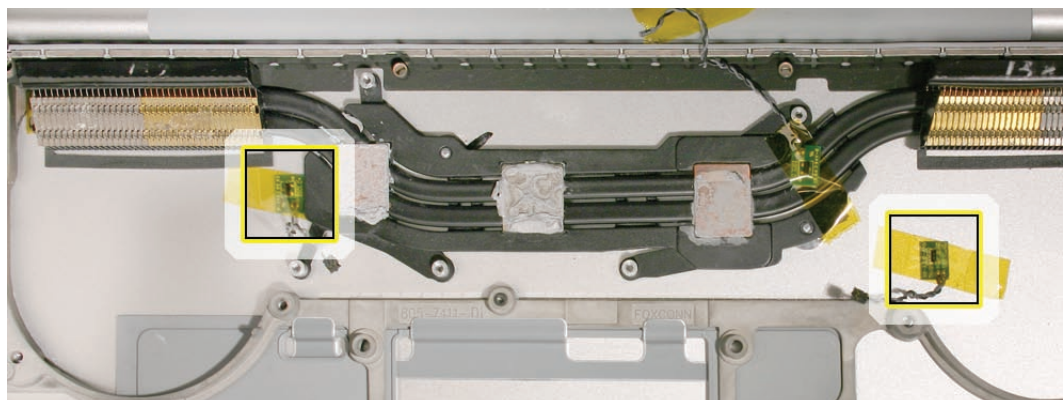

Procedure

1. For any of the sensors, peel back any Kapton tape, then before removing the board, mark the outline of its position with a permanent fine-point felt-tip marker.

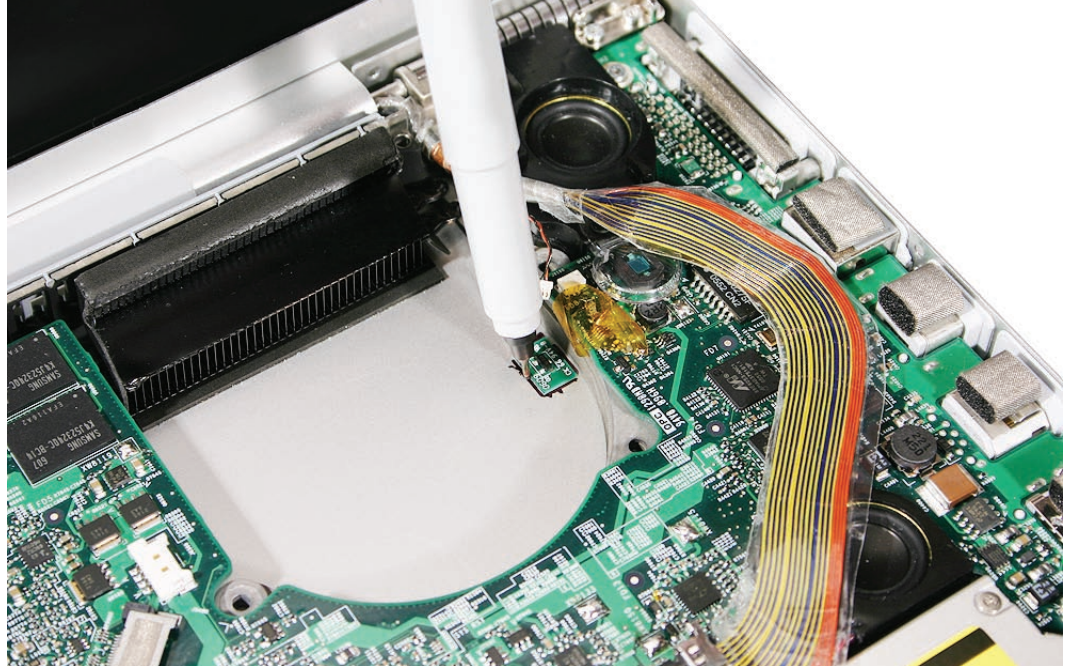

2. Pry up the sensor board with a razor knife.

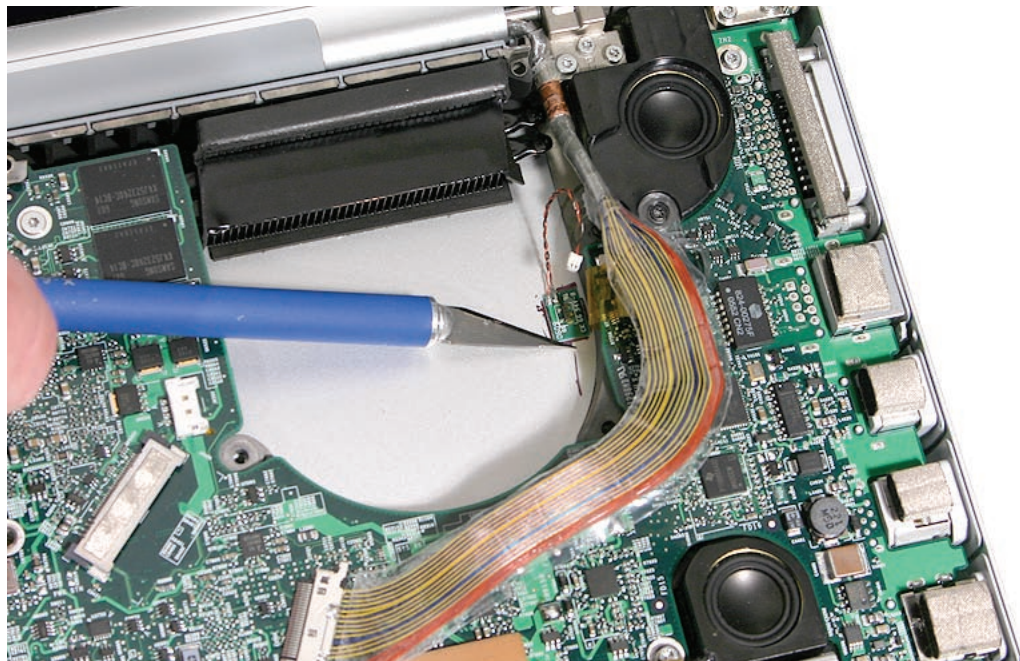

-
3. **Note:** The connector for the heatsink sensor is disconnected when removing the logic board.
When removing the bottom case sensor on the MacBook Pro (17-inch), use a needlepoint probe to disconnect the cable connector from the logic board.

Warning: When using a needlepoint probe, great care must be used to avoid slipping off the connector and damaging components.

Note: The MacBook Pro (17-inch Core 2 Duo, 2.4GHz and Early 2008) will have JST connectors on the bottom case thermal sensor(s) and the heatsink thermal sensor.

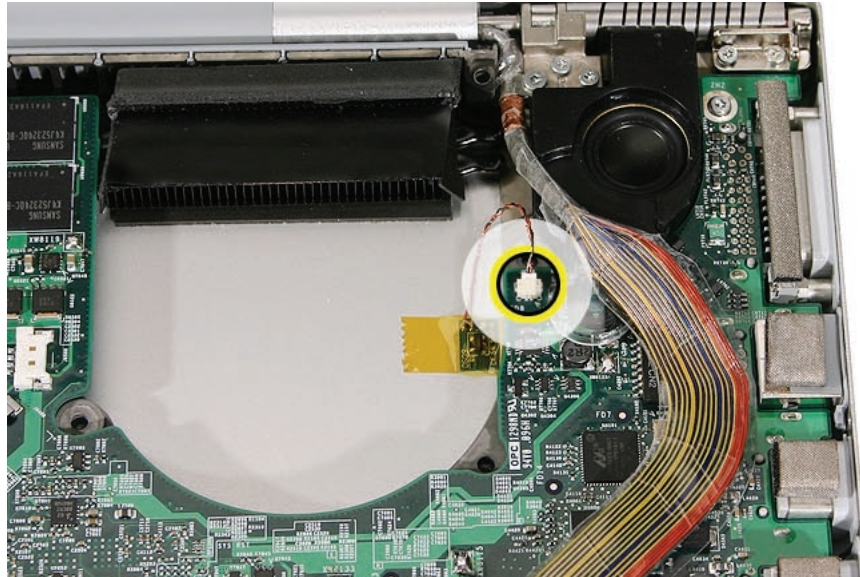

4. Install the replacement sensors in the exact same location.
5. Replace any Kapton tape.



Heatsink

Tools

This procedure requires the following tools:

- Black stick (nylon probe 922-5065) or other non-conductive nylon or plastic flat-blade tool

Preliminary Steps

Before you begin, remove the following:

- [Battery](#)
- [Top Case](#)
- [Logic Board](#)

Part Location

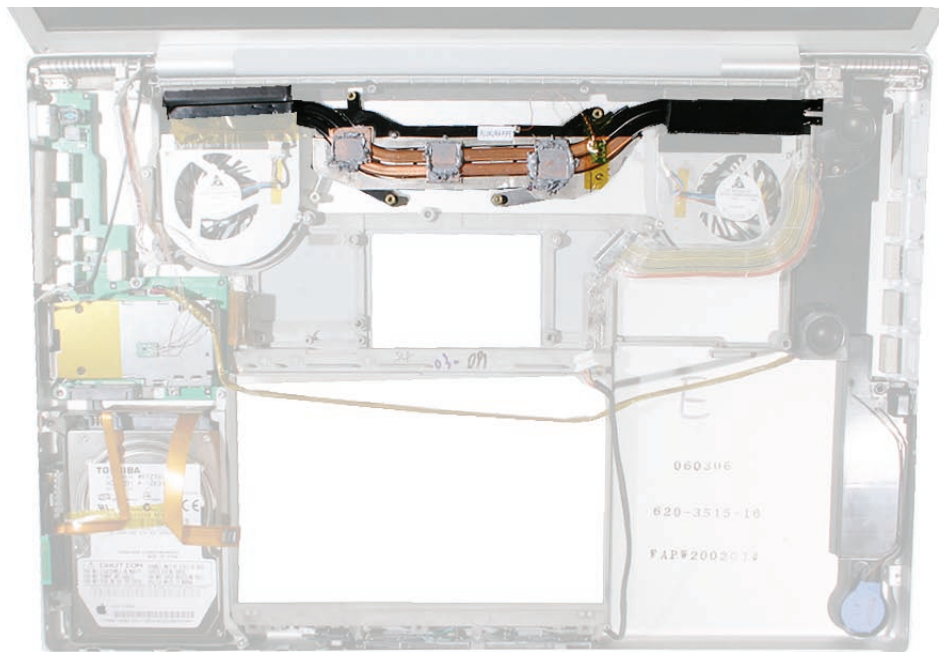

Procedure

Note: Some photo details below may differ slightly from the model of 17-inch MacBook Pro you are repairing; however, the procedure itself remains consistent for any of the models.

1. If the fans will not be removed, cut the tape between the fans and the heatsink (as described in the [Fans](#) Chapter), then lift out the heatsink.



2. When installing the heatsink, make sure that it fits over the pins, shown, and lays flat.

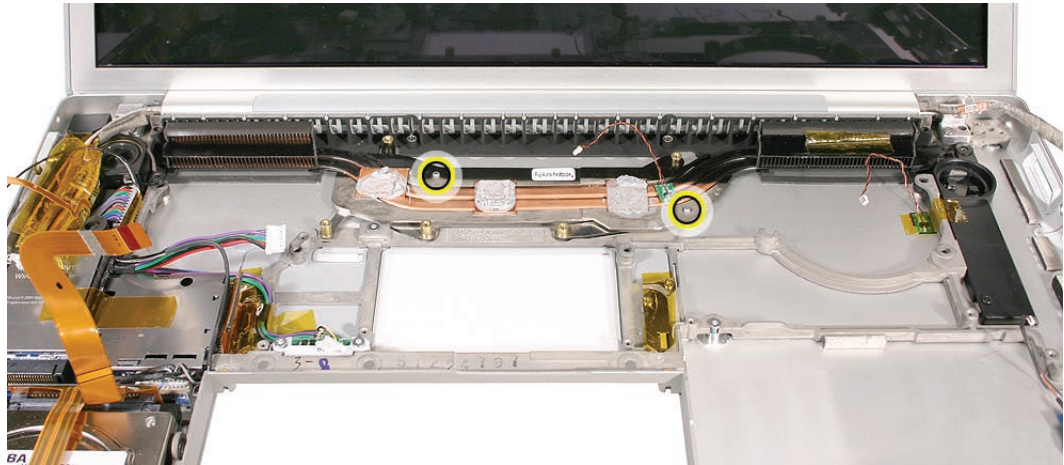

3. Make sure to install new thermal grease as outlined in the [Logic Board](#) chapter.



Bottom Case

Tools

This procedure requires no tools.

Preliminary Steps

Before you begin, remove the following:

- [Battery](#)
- [Top Case](#)
- [AirPort Extreme Card](#)
- [Hard Drive](#)
- [Bluetooth](#)
- [Infrared Board](#)
- [Optical Drive](#)
- [Speakers](#)
- [Left I/O Board](#)
- [Fans](#)
- [Logic Board](#)
- [Heatsink](#)
- [Display Assembly](#)

Part Location

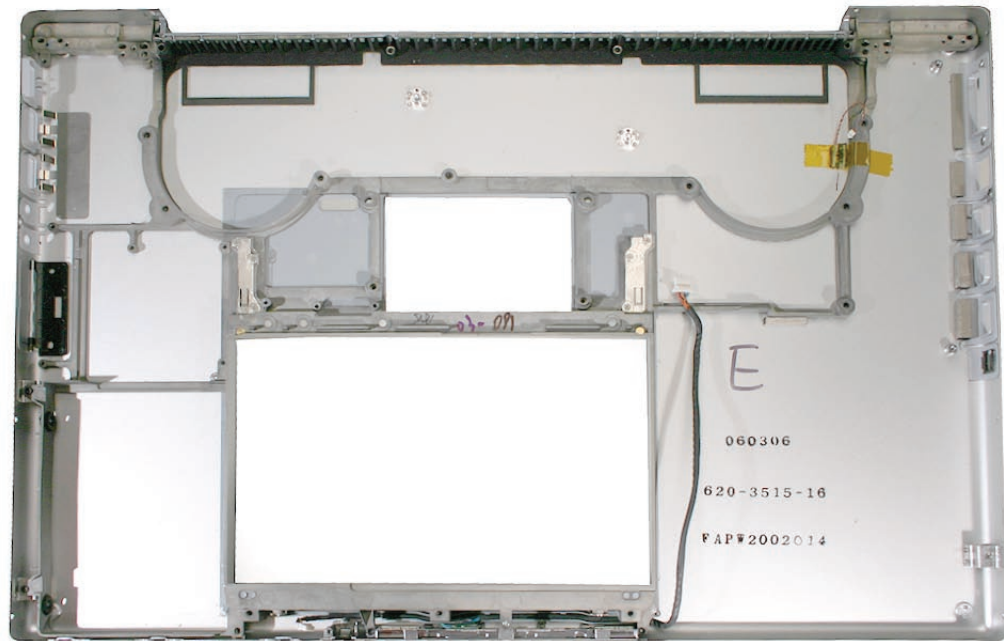

Procedure

Note: If replacing the bottom case, use a razor knife to carefully lift and transfer the Serial Number and Ethernet ID labels to the replacement bottom case.

After the parts are removed in the preliminary steps, what's left is the bottom case..



Display Assembly

Tools

This procedure requires the following tools:

- Torx T6 screwdriver (magnetized)
- Black stick (nylon probe 922-5065) or other non-conductive nylon or plastic flat-blade tool

Preliminary Steps

Before you begin, remove the following:

- [Battery](#)
- [Top Case](#)

Part Location



Procedure

Note: Some photo details below may differ slightly from the model of 17-inch MacBook Pro you are repairing; however, the procedure itself remains consistent for any of the models.

1. Disconnect two antenna connectors for the MacBook Pro (17-inch original and Early 2008) or three connectors for the MacBook Pro (17-inch Core 2 Duo and 2.4GHz) from the AirPort Extreme card. Lift straight up.

Note: Take note of the order of the antenna connectors for reinstallation purposes.

2. Disconnect three cable connectors on the logic board—the camera and inverter connectors and the LVDS connector.



3. Remove the four clutch spring end cap screws, two each side.

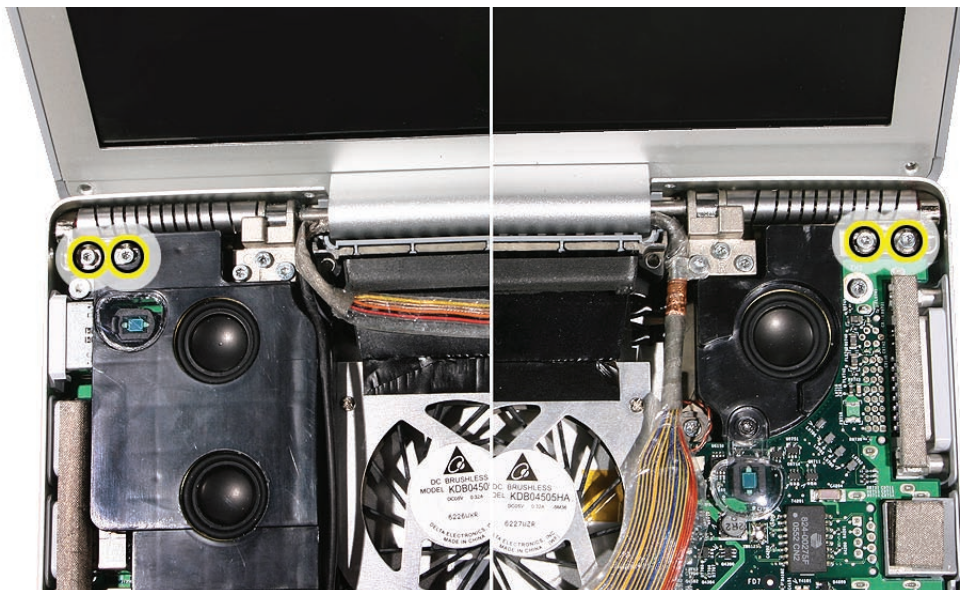

4. Move the display straight up to a 90-degree angle and remove six clutch block screws, three on each side.

Important: Support the display from falling over before removing the last screw.

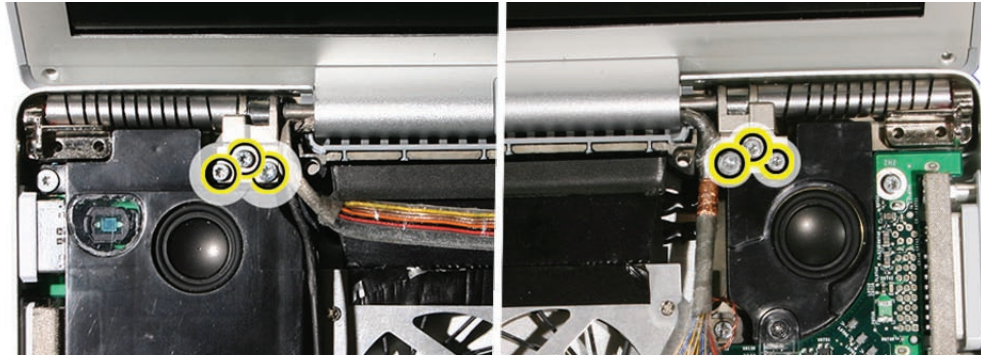

5. Lift the display straight up and off of the computer without catching wires.



6. Remove the clutch spring end caps from each side.

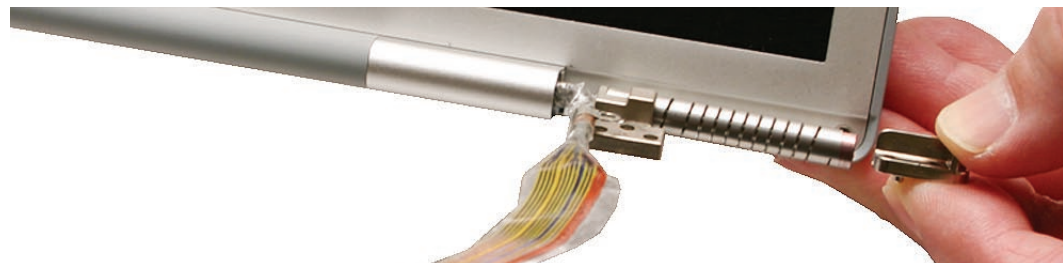

Replacement Procedure

1. Before installing the display assembly, verify that all cables are routed out of the way.
2. Install the replacement display assembly, and reconnect all cables and antennas.
3. Make sure to capture the LVDS cable grounding loop with the screw, and that the cable is secure and lays flat.



4. Verify that the EMI gasket is on the camera cable connector.

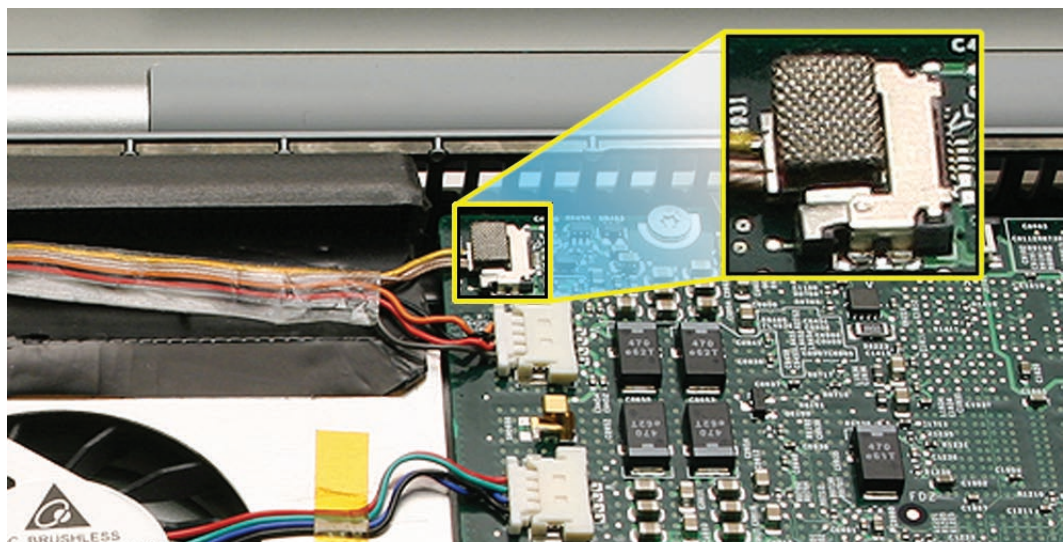

5. Verify that the antenna cables lay flat within the channel along the edge of the speaker.

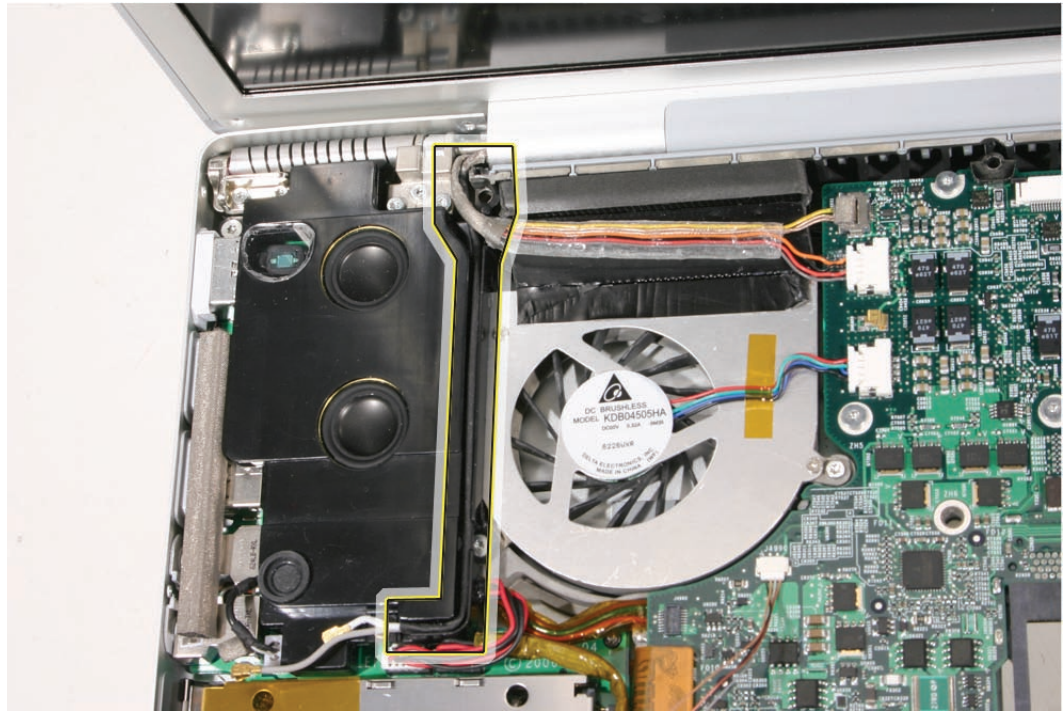

6. If not, use Kapton tape to secure, as shown.

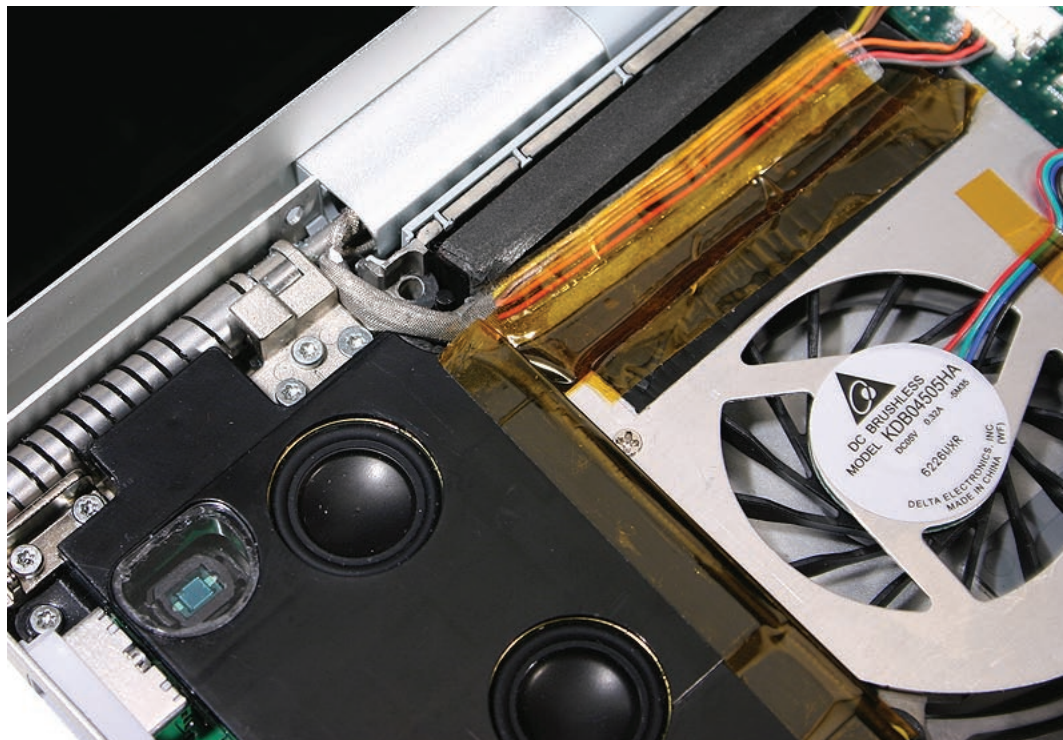

7. And verify that the cables for the antennas, and camera and inverter, route to the left of the pin and screw hole at the top right corner of the speaker.

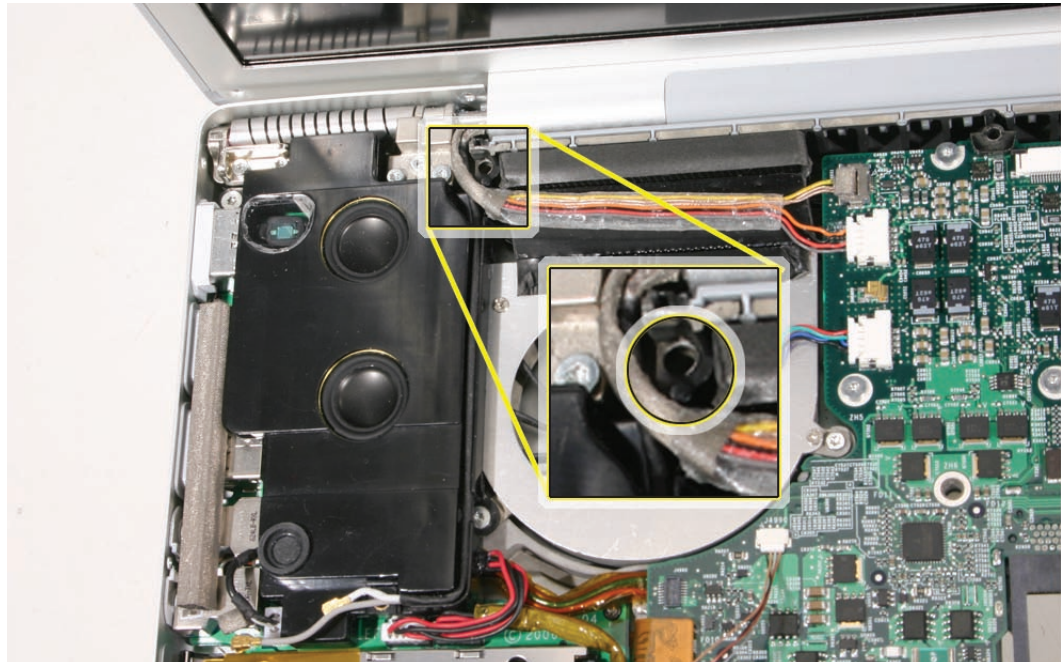

8. Reassemble and test the computer.
9. Testing the computer should include:
 - Testing that the display panel functions properly.
 - Use Apple System Profiler to check that the AirPort Extreme card is recognized, and test that AirPort Extreme is working.
 - Check the camera function.
 - Check that the trackpad and keyboard function properly.
 - Operate the computer in a darkened room to check for keyboard backlight function.

Apple Service Source

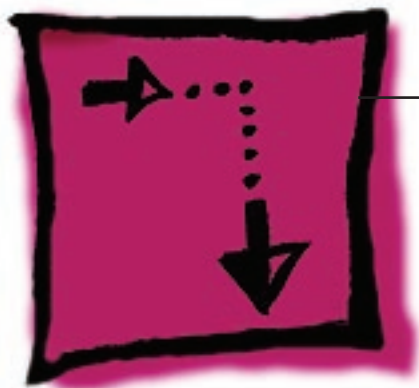

Adjustments

MacBook Pro 17-inch
(original, Core 2 Duo, 2.4 GHz,
Late 2007 CTO, and Early 2008)

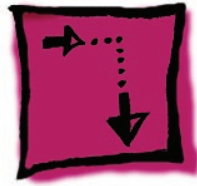

Latch Adjustment

Overview

To secure the display to the top case, the MacBook Pro uses a latch assembly that consists of two parts—a latch mechanism under the top case (actually attached to the bottom case frame) and two swinging latch hooks inside the display assembly clamshell. As the unit is closed, magnets inside the latch mechanism pull the metal latch hooks down into the bottom case, and an overhang on the latch mechanism clasps the hooks to the frame.

If the display does not properly latch to the top case, fails to remain closed, or pops up without the display release button being pushed, you can make adjustments to the latch hooks that may correct the issue. Alternately, you can send the computer to an Apple Repair Center for service.

Tools

This procedure requires the following tools:

- Black stick (or other non-marring nylon or plastic pointed tool)
- Magnet

Preliminary Steps

Warning: While performing the following procedures, take note of the position of the hooks as they are drawn out of the display housing and down into the slots in the top case. Any adjustments to these hooks must be very slight to stay within the slot on the top case.

Before performing the latch adjustment, test the current operation of the latches:

1. Push the display down to about two inches from the top case. Then push the display very slowly until it just touches the top case, and immediately release.

If working properly, the latches should secure the display to the top case throughout the following tests:

- Pounding firmly on the table top, to the left and right of the computer.
- Pulling up on the sides of the display.

Repeat the above procedures several times to verify proper operation of the latches.

2. Whether or not the latches functioned properly during testing, use the following procedures to achieve or to verify proper latching function.

Procedure

Note: The latch mechanism under the top case of the computer has a small amount of right and left play (less than 1 mm), and can shift during normal operation.

The following procedures will test the latching function with the latch mechanism at its maximum right and left positions, and the latch hooks will be very slightly adjusted, as necessary.

Important: The latch hook metal can become brittle and break if it is bent too much, especially if it is over-bent and bent back. Work carefully and with due restraint to avoid over-bending the latch hook. If the latch hook breaks, new latch hooks will need to be ordered and replaced.

1. Open the display and note the edges of the latch mechanism underneath the top case, shown below, just to the right and left of the latch release button. This mechanism catches both left and right latch hooks on the display assembly.



2. Use a black stick to push the latch mechanism, at the location shown below, to move it to the left as needed (less than 1 mm) or its corresponding location on the left side of the latch release button to move it right (less than 1 mm).



3. Perform the testing procedures in step 1 of the Preliminary Steps, above.
4. If the latch functions properly, skip to step 6; otherwise, if either or both latch hooks require an adjustment, refer to the following steps.
5. If the latch mechanism does not function properly, adjust the latch hook(s) as follows:

Open the display to a 90-degree angle and use a magnet to draw the latch hook out. Tightly grasp it between your thumb and forefinger as close to the display as possible, as shown.



Carefully exert a very slight controlled downward pressure on the latch hook.

Important: Do not push only with your thumb. Hold the latch hook tightly between your thumb and forefinger to support the latch hook and prevent too much bending force.

6. Release the latch hook, adjust the other latch hook as needed, and perform the latch tests as before. Continue the above procedure until both latches function properly.
7. Again, if needed, use a black stick to push on the latch mechanism, as shown below, to adjust it slightly left or right (no more than 1 mm) or to re-center the mechanism over the latch release button.



8. Repeat the previous latch closing tests, and latch hook adjustment if needed, until the latch works properly in this position.

Apple Service Source



Troubleshooting

MacBook Pro 17-inch
(original, Core 2 Duo, 2.4 GHz,
Late 2007 CTO, and Early 2008)



General Information

Wire and Flex Cables

Because of its extremely thin enclosure design and dispersed circuit board, the MacBook Pro utilizes a large number of flex cables and variety of wire cable harnesses. Many of these cables carry multiple types of signals.

Here is a list of the cables and the signals that run across them. If you notice a group of functions not working, it is likely that the cable is not properly inserted or the connector is damaged.

Cable or Flex Cable	Signal(s) Running Through It
SuperDrive flex	SuperDrive data, power, and control signals (cable select info)
Hard drive flex	Hard drive power and data Bluetooth power and data
Left I/O board flex	Audio in and out left USB (2 ports) ExpressCard data, left ALS, AirPort
Power Button cable	Power-on signal
Infrared Cable	Infrared Power and data
Sleep LED cable	Power to sleep LED
Main battery connector wire harness	Battery power to main logic board
Speaker Assembly cable (left)	Left speakers (2) audio
Speaker Assembly cable (right)	Right speakers (2) audio
Internal microphone	Internal microphone audio
Trackpad flex	Trackpad data and power Power on button Keyboard backlight power Sleep sense signal Keyboard data
Bluetooth antenna cable assembly	Bluetooth radio signal
AirPort Extreme antenna cable	AirPort Radio signal
Left fan cable	Power/control for left fan
Right fan cable	Power/control for right fan
Display backlight cable (to logic board)	Display backlight control Inverter control signal (brightness)
iSight video signal cable	Video power and signal from iSight camera
LVDS cable	Video data
Thermal sensors (bottom case (2), heatsink)	Internal temperature data

Microphone and Camera wires

The following photo shows the microphone wires located on the left speaker, and the camera connector located on the logic board.

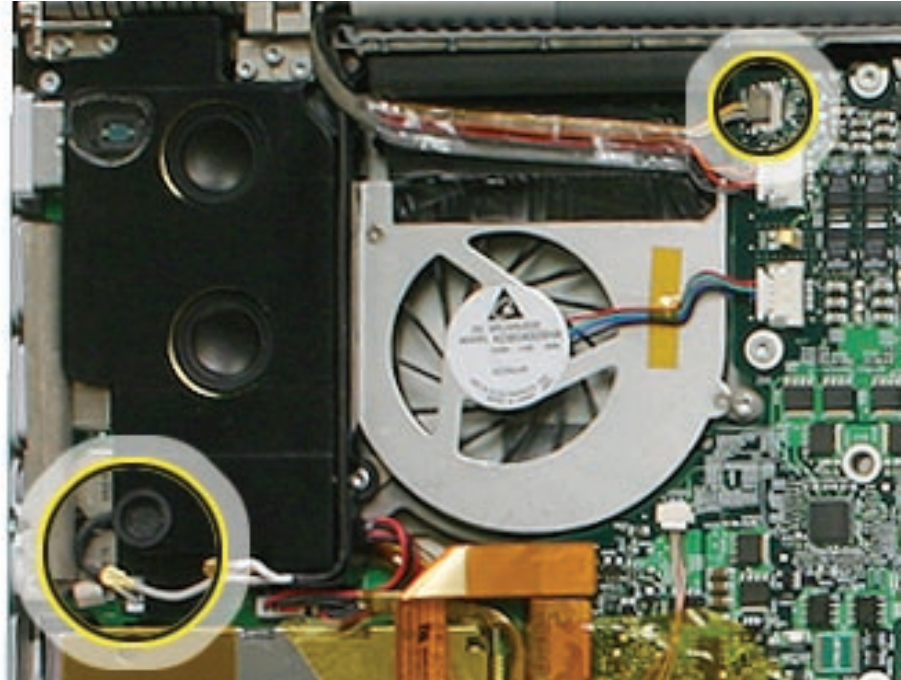

Hardware Diagnostics

AppleCare offers two diagnostics for the MacBook Pro. Apple Hardware Test (AHT) is shipped with every machine and targeted for end-users to troubleshoot their machine. Apple Service Diagnostics (ASD) is offered to Service Providers for more in-depth troubleshooting.

Both applications are available for download from Kbase article 112125: Service Diagnostics Matrix.

Apple Hardware Test (AHT)

- Apple Hardware Test (AHT) 3A105 for MacBook Pro (17-inch)
- Apple Hardware Test (AHT) 3A115 for MacBook Pro (17-inch Core 2 Duo)
- Apple Hardware Test (AHT) 3A122 for MacBook Pro (17-inch 2.4GHz)
- Apple Hardware Test (AHT) 3A135 for MacBook Pro (17-inch Early 2008)

Note: AHT version numbers may change as diagnostics are updated.

To use Apple Hardware Test on the hard drive (MacBook Pro (17-inch Early 2008) only):

1. Disconnect all external devices from the computer except the power adapter.
2. Restart the computer while holding down the D key. (Apple Hardware Test resides on its own

partition on the internal hard drive.)

3. When the AHT chooser screen appears, select the language for your location.
4. Press the Return key or click the right arrow button.
5. When the Apple Hardware Test main screen appears (after about 45 seconds), follow the on-screen instructions.
6. If Apple Hardware Test detects an issue, it displays an error code. Make a note of the error code before pursuing support options. If Apple Hardware Test doesn't detect a hardware issue, the issue may be software related.

If this method is not successful, use AHT from the MacBook Pro OS X Install DVD..

To use AHT from the DVD:

1. Insert the DVD named "MacBook Pro Mac OS X Install Disc 1" that came with your computer.
2. Hold down "D" and restart the computer.
3. Follow the on-screen instructions.

Apple Service Diagnostic (ASD)

- Apple Service Diagnostic (ASD) 3S108 for MacBook Pro (17-inch)
- Apple Service Diagnostic (ASD) 3S109 for MacBook Pro (17-inch Core 2 Duo)
- Apple Service Diagnostic (ASD) 3S114 for MacBook Pro (17-inch 2.4GHz)
- Apple Service Diagnostic (ASD) 3A121 for MacBook Pro (17-inch Early 2008)*

Notes:

- ASD version numbers may change as diagnostics are updated.
- Some older diagnostics are not on the 3S109 disk. Please keep a copy of the 3S108 disk.

***Important:** ASD 3S121 requires installation onto an external USB hard drive. See section below.

Installing Apple Service Diagnostic on a USB hard drive:

1. Connect the external USB hard drive to your Macintosh.
2. Open Disk Utility (located in /Applications/Utilities).
3. Select the external USB hard drive.
4. Click the Partition tab to prepare the drive to be partitioned into two volumes, as follows:
 - For ASD (OS), the partition size must be 5.4GB or larger. Name this volume ASD OS 3S121.
 - For ASD (EFI), the partition size must be 20MB or larger. Name this volume ASD EFI 3S121.
5. Click on Options and select GUID Partition Table as the partition scheme.
6. Click Partition to partition the hard drive.
7. In the Finder, double-click on the ASD 3S121.dmg file to mount the image. Within it are two disk images, one for EFI, ASD EFI 3S121.dmg, and one for OS X, ASD OS 3S121.dmg volume.

8. In Disk Utility, select the volume on the USB hard drive named “ASD OS 3S121.”
9. Click on the Restore tab.
10. For Source, select the ASD OS 3S121 disk image by either dragging the icon for the disk image to the Source window, or selecting it by clicking on the Image... button.
Note: Image ASD OS 3S121.dmg should be unmounted before restoring it to the hard drive.
11. For Destination, drag the icon for the volume ASD OS 3S121 from the left-hand column to the Destination window.
12. Click the Restore button to start the installation.
13. In Disk Utility, select the volume on the USB hard drive named ASD EFI 3S121.
14. Click on the Restore tab
15. For Source, select the ASD EFI disk image by either dragging the icon for the disk image to the Source window, or selecting it by clicking on the Image button.
Note: Image ASD EFI 3S121.dmg should be unmounted before restoring it to the hard drive.
16. For Destination, drag the icon for the volume ASD EFI 3S121 from the left-hand column to the Destination window.
17. Click the Restore button to start the installation.

Troubleshooting Aids and Tips

Power Button pads on logic board

With the top case removed, the power button is disconnected. Instead of having to reconnect the top case to turn on the system, there are two pads on the logic board that can be shorted across (with a tool like a flat blade screwdriver) to act as the power button.

These pads are located near the left side of the LVDS cable connector on the logic board. It is marked PWR BTN. The pads are separated with a vertical white line.

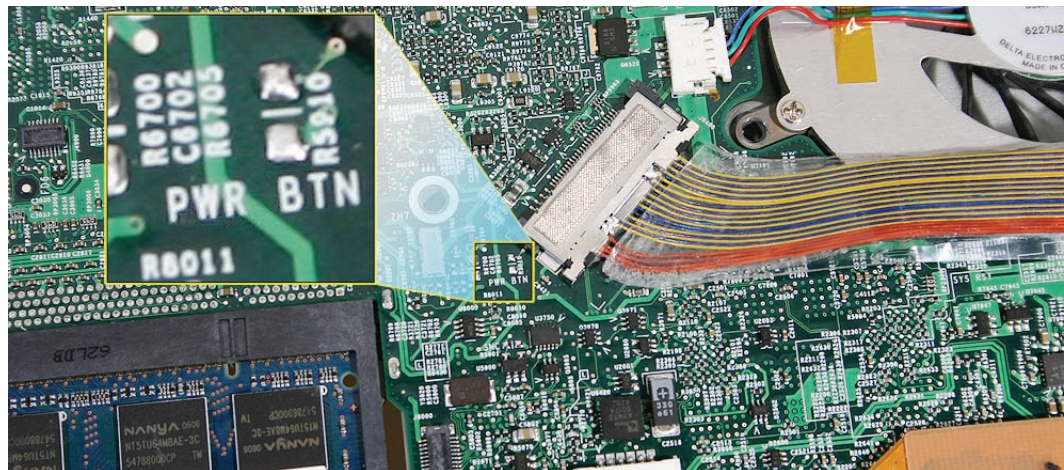

Resetting the System Management Controller (SMC)

Power management is now handled by a chip called SMC (System Management Controller). Previously, it was handled by the Power Management Unit (PMU). To reset the SMC:

1. If the computer is on, turn it off.
2. Disconnect the power adapter and remove the main battery.
3. Hold the power button down for five seconds, then release.
4. Install the main battery and connect the power adapter.
5. Press the power button to restart the computer.

Display off and sleep indicator light on

When the system is running but the video is not illuminated (for example, briefly upon startup, or when energy saver dims the video while the system is still awake), the sleep indicator light remains on. This feedback is to alert the user that the system is not shut down. It is possible, however, that this signal may fail if the system has crashed. As such, you can use the next test to see if power is present in an apparently “off” system.

System powered test using Caps Lock LED

There are situations when the system is giving indications that it is shut down (no sleep light, no hard drive access, screen is dark, no fan, and so on); however, the logic board may still be active. In this case, the logic board is drawing power and generating heat.

Warning: In this situation, if the computer is placed in an enclosed environment like a carrying bag, the computer can overheat.

You can potentially verify this situation by pressing the Caps Lock key. If the LED glows, the power manager is actively running on the logic board. If pressing the Caps Lock key or other attempts to wake the machine have failed (including closing the lid to put it to sleep and reopening it to wake it), hold the power button down for six seconds to force a shutdown of the computer. Restart the system to check that it starts up normally.

Note: Given that the keyboard in MacBook Pro is a USB device, it may not respond if the operating system has crashed. Thus, despite the fact that the caps lock LED does not light up, the computer may still be drawing power. If in doubt, hold the power button down for six seconds to force a shutdown of the computer.

MacBook Pro Firmware Updates

Firmware is the name given to software that is written into memory circuits such as flash memory, that will hold the software code indefinitely, even when power is removed from the hardware. Firmware on Intel Mac computers is designed to be updated if necessary through a software update.

EFI and SMC firmware is stored on the MacBook Pro's logic board. EFI firmware updates update the Boot ROM, and SMC Updates update the System Management Controller firmware. The SMC manages fans and other environmental parameters that are independent of the Boot ROM.

Firmware symptoms can be easily mistaken for hardware issues (e.g. overheating issues, fan noise issues, etc.). Always check both EFI and SMC firmware versions and update if necessary before replacing any hardware components in the MacBook Pro.

The following lists describe the type of symptoms that may be resolved by updating the EFI and SMC firmware in the MacBook Pro.

Symptoms that may be resolved by updating EFI firmware:

- L1 Cache reporting as bad
- Boot Camp not booting into Windows
- Built-in FireWire has GUID zero if ExpressCard FireWire is present at boot
- Auto-reboot after wake from sleep
- Stuck in Target Disk Mode upon restart
- Cannot eject media (various conditions)
- Bad media taking too long to eject (including holding mouse button down at startup taking minutes to eject)
- Auto-reboot after wake from sleep

Symptoms that may be resolved by updating SMC firmware:

- Status LEDs on battery do not light until the pack has charged for approximately 10 minutes
- Unusual fan behavior and thermal management issues

Please follow the steps outlined in Knowledge Base article 303364 About firmware updates for Intel-based Macs to perform an EFI and/or SMC firmware update.

Information about firmware versions for Intel Macs can be found in Knowledge Base article 303880 Mac OS X: Firmware Updates for Intel-based Macs.

Software Troubleshooting Tips and Tools

All MacBook Pros require an Intel-compatible Mac OS.

- For the MacBook Pro (17-inch), use Mac OS X 10.4.6 or later only.
- For the MacBook Pro (17-inch Core 2 Duo), use Mac OS X 10.4.8 or later only.
- For the MacBook Pro (17-inch 2.4GHz), use Mac OS X 10.4.9 or later only.
- For the MacBook Pro (17-inch Early 2008), use Mac OS X 10.5.2 or later only.

Login window and account

Mac OS X requires at least one user account to be established—the Administrator’s account. By default, the Accounts system preference pane has the “Log in automatically [Admin’s name]” checked. This automatic login setting allows the system to boot into the Finder without having a login prompt. However, if this box is not checked, you need a password to get to the Finder, and you need to create a user account after you reinstall system software.

Customer forgot password

If the customer forgot the password for the computer:

1. Insert the MacBook Pro Mac OS X Install Disc 1 DVD.
2. Restart the computer while holding down the C key on the keyboard.
3. When the installer appears, chose Reset Password under the Installer Utilities menu
4. Follow the on-screen instructions.

Safe Mode

Safe Boot is a special diagnostic way to start Mac OS X when troubleshooting. Safe Mode is the state Mac OS X is in after a Safe Boot. Starting up in Safe Mode does five things to simplify the startup process and operation of the computer:

- It forces a directory check of the startup (boot) volume. It is identical to using Disk Utility’s Repair Disc or the `fsck -fy` terminal command.
- It loads only required kernel extensions (some of the items in `/System/Library/Extensions`).
- It disables all fonts other than those in `/System/Library/Fonts`
- It moves to the Trash all font caches normally stored in `/Library/Caches/com.apple.ATS/(uid)/`, where (uid) is a user ID number such as 501.
- It disables all startup items and any Login Items.

To start up into Safe Mode (to Safe Boot), do this:

1. Be sure the computer is shut down.
2. Press the power button.

-
3. Immediately after you hear the startup tone, press and hold the Shift key.

Note: The Shift key should be held as soon as possible after the startup tone but not before.

4. Release the Shift key when you see the screen with the gray Apple and progress indicator (looks like a spinning gear). After startup, the words “**Safe Boot**” appear in red letters under the Apple logo on the Mac OS X login screen.

Note: The Safe Boot startup process takes longer than a normal startup. It can be quite long (several minutes) depending on the amount of time it takes to check and repair the directory (if needed).

5. To exit Safe Mode, restart the computer normally, without holding down any keys during startup.

Knowledge Base Articles

These troubleshooting articles can be searched from <http://www.apple.com/support>.

- 107392 What is Safe Boot, Safe Mode?
- 107394 Safe Boot Takes Longer Than Normal Startup
- 106692 Mac OS X: Troubleshooting Installation and Software Updates
- 106693 Mac OS X: Troubleshooting Installation From CD-ROM





Troubleshooting Steps

You should perform the first few steps of troubleshooting regardless of whether there is a repairable problem or damage.

Gather Information

Gather the normal information about the problem. (If you are not familiar with the normal information to gather, or any of the other steps, see General Troubleshooting Theory.)

Verify the Problem

Verify that the symptom exists as the customer reports it.

Try Quick Fixes

Special quick fixes that apply to this computer include:

- Familiarize yourself with the unit's normal operating temperature (see Knowledge Base document 30612)
- Make sure cable connectors are fully seated
- Reset the SMC. (See Knowledge Base document 303319).

For more details, see the Symptom Charts section.

Run Diagnostics

The following diagnostic tools are available for this product:

- Apple Hardware Test
- Apple Service Diagnostic

See Knowledge Base document 112125, "Service Diagnostic Matrix," to download the appropriate disc image.

Try Systematic Fault Isolation

There are no special systematic fault isolation techniques for this product.

Research

If you have not located the trouble following the steps thus far, try researching the symptoms.

Research resources include:

- Symptom Charts section of this manual
- GSX
gsx.apple.com
Enter serial number and click Coverage Check
- Service Source
service.info.apple.com
Check Quick Links and/or Technical Resources
Check options under appropriate Product Service pop-up menu
- Product support page
service.info.apple.com
Choose MacBook Support Page from the appropriate Product Service pop-up menu
- Knowledge Base
search.info.apple.com
- Self-paced service training
service.info.apple.com
Choose Service Training from the Product Service pop-up menu

Escalate

Follow the practices and policies of your business or agency.

Repair or Replace

Once you locate the trouble, you will most likely need to repair the unit, or mail it in to an AppleCare Repair Center, depending on the service strategy in your region. Be sure to include the CompTIA code, the troubleshooting steps you performed, and the results in the Service Instructions section of GCRM and/or GSX.

If the symptoms point to a component on the logic board, use the block diagram at the end of this chapter to help determine whether you need to replace the entire logic board.

Verify the Repair

To verify the repair:

1. Attempt to recreate the original symptoms. You should not be able to. (If you can, return to the beginning of the troubleshooting flowchart.)
2. Perform the preventive maintenance tasks for this product. For this computer this includes only cleaning the display and case.

Inform the User

Include in the case notes all that you have done. The customer may like a copy of any diagnostic reports.

Important: For any unit you send on to a repair center, include the CompTIA code, symptoms, steps to reproduce, and troubleshooting steps you have completed thus far in the Service Instructions section of GCRM and/or GSX. (Service Instructions are also known as FAI notes.)

Complete Administrative Tasks

There are no particular administrative tasks for this product, other than those required by the internal policies of your business or agency.



Hardware Symptoms

How to Use the Symptom Charts

The Symptom Charts included in this chapter will help you diagnose specific symptoms related to the product.

The steps to solve a symptom are listed sequentially. You might not need to perform every step before the symptom is resolved. Start with the first step, and then test for the symptom. If the symptom persists, replace any modules you removed, go to the next step, and test again. Continue down the list until the symptom is resolved.

Startup

Startup Sequence

The Intel-based MacBook Pro starts up very much like the previous professional Macintosh notebook computers. If power is available to the system from the battery and/or AC power adapter, pushing the power button will boot the system and begin the boot process.

- The screen will stay dark. The sleep LED will glow solid. This will last a few seconds.
- As the system boots, a power-on self test (POST) will be performed. See *POST Error Codes* listed later for failure results.
- If the system is not muted, you will hear a boot beep. The backlight will turn on and the sleep LED will turn off.
- The screen will turn gray. The Apple logo will appear and then the turning gear will appear.
- The desktop pattern will show up, as well as the menu bar start populating.

No Power, No Video

The computer will not power on (no sleep light, no fan movement, no hard drive spin-up, no Caps Lock LED illumination when pressed, and no display illumination).

Note: After each step, check that the system is not supplying power to the logic board. If you see the sleep LED come on or the Caps Lock LED illuminate when the key is pressed, then the system is indeed drawing power. In this case, hold down the power button for six seconds to insure the system is shut down before working on the machine. At this point, the issue is no longer a 'No Power, No Video' problem. Move on to the *Power, but No Video* troubleshooting section.

Note: Examine the display carefully. An image may be barely present on the screen, but with no backlight clearly illuminating the image. In this case, the system is working properly except for the backlight. Use the *Display: Dim Video* troubleshooting section to resolve this issue.

-
1. Remove any connected peripherals and eject any ExpressCard.
 2. Check that the battery has enough charge to start the computer by pressing the button next to the LEDs on the battery (on the bottom of the machine). At least one LED must light solid (not flashing). Make sure the battery is fully seated.
 3. Connect a known-good Apple 85W Portable Power Adapter and power cord or plug to a known-good power outlet. If the DC plug is properly inserted, the LED should light up; if not, go to the *MagSafe connector* troubleshooting section.
 4. Try powering up without the battery installed. If it boots, try a known-good battery. If it does not boot, replace the battery connector cable.

Note: With the MacBook Pro (17-inch 2.4GHz and Early 2008), unlike previous models, if you use the MacBook Apple 60W Portable Power Adapter to power the system, the battery will need a minimum charge to be able to boot the system. If the battery is fully depleted and no 85W adapter is available, allow the battery to charge first before turning on the system.

5. Reset the SMC (power manager) as described in “Resetting the System Management Controller (SMC)” under “Troubleshooting Tips and Tricks” in the previous section.
6. Try to power up the system and check the sleep indicator. If it turns on solid and turns off, the main logic board is getting power and completing the boot cycle. Go to the *Power, but No Video* troubleshooting section.
7. Verify that the power button cable is connected properly to the top case flex cable assembly and that the flex cable is connected correctly to the logic board. Try turning on the system.
8. Disconnect the keyboard completely. Inspect the connectors. With the keyboard disconnected, restart the system using the on-board startup jumper pads. If it boots, replace top case.
9. Remove any additional RAM.
10. Try removing the AirPort Extreme card from its socket and start the computer. If it starts, shut it down and check the flex cable connector and the connector on the logic board and replace the damaged parts.
11. Reseat these flex cables:
 - Left I/O flex cable
 - Hard drive flex cable (will boot to flashing folder if not connected or corrupt)
 - Optical drive flex cable
 - Trackpad flex cable
 - Display LVDS cable
 - Thermal sensor cables
12. If the computer starts up, inspect any suspect flex cable connectors and their terminals on the logic board for damage and replace any damaged parts.
13. Replace the left I/O board.)
14. Replace the logic board.

Power-On Self Test (POST) Error Codes

The computer automatically performs a power-on self test when it is turned on after being fully shut down (not a restart). This section describes what to do if you hear beeps during startup. When this occurs, the sleep LED will stay on, occasionally flashing.

MacBook Pro relies on a combination of tones and blinking sleep LEDs to display power-on self test (POST) error codes.

If the computer detects no SDRAM (Synchronous Dynamic Random Access Memory—also referred to as RAM), or the RAM installed does not meet the appropriate specifications, the screen will remain black but the power LED on the front of the computer will blink once per second to signal the error. This error condition may be due to physically damaged RAM, the incorrect type of RAM, or not having any RAM installed.

Some RAM may appear to pass the power-on self test (POST) but still cannot be addressed by the operating system. In this case, the computer will display a gray screen, sound three tones and blink the power LED on the front of the computer three times, pause, and repeat the blinking until the computer is turned off.

Related Knowledge Base articles:

303083: Intel-based Mac Power On Self Test RAM error codes

303363: Intel-based Mac: Startup sequence and error codes, symbols

Blue screen appears (a spinning disc cursor may also be visible), Prohibitory Sign appears (a), Kernel Panic dialog box appears (b), or Gray screen during startup

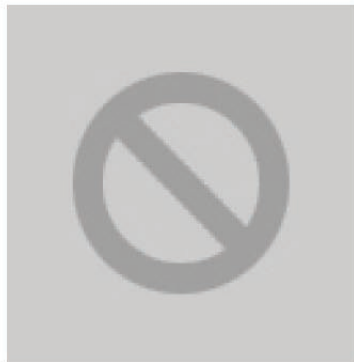

a) Prohibitory sign

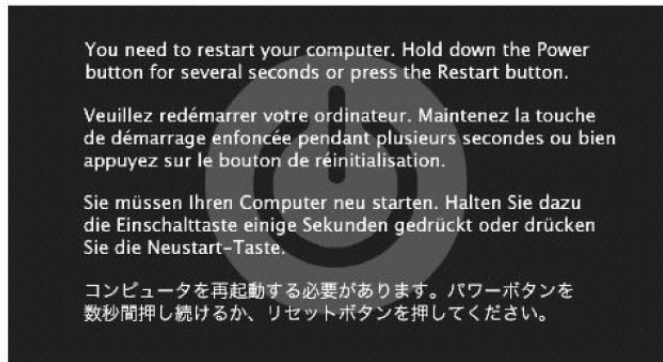

b) Kernel panic dialog box

1. Make sure all external devices are disconnected and any ExpressCard has been ejected. If the kernel panic goes away, troubleshoot the external device by reconnecting each device until the panic occurs.
2. If there are two RAM cards installed in the expansion slots, remove the top card and restart.
 - If symptom repeats, replace bottom card with known-good RAM card.
 - If symptom does not repeat, replace top RAM card with known-good RAM card and restart.

Flashing question mark appears on the screen

Note: This system will only boot with the version of Mac OS X system that shipped with this computer or later. It does not support booting into Mac OS 9.

1. Start up from the MacBook Pro Mac OS X Install Disc 1 DVD that came with the computer (hold down the “C” key during restart).
2. When the Installer opens, select Disk Utility from the Installer menu under Utilities.
3. When Disk Utility opens, all mounted disk and volumes will be listed on the left hand side. If you don’t see the internal hard drive, the system is not recognizing it. Skip to the next step. Otherwise, select the internal hard drive icon and follow the instructions under the First Aid tab to verify the hard disk, and repair if needed. Restart the computer.
4. If Disk Utility is unable to repair a persistent directory issue or corrupt file information, consult the following articles for possible solutions:
 - 106214: Using Disk Utility and fsck to resolve startup issues or perform disk maintenance
 - 25770: Handling “overlapped extent allocation” errors reported by Disk Utility or fsck
 - 302411: Disk Utility reports “Underlying task reported failure” when repairing a volume
5. If the hard drive is still not recognized, refer to the *Internal Hard Drive Not Recognized* troubleshooting section.
6. Reinstall system software using the MacBook Pro Mac OS X Install 1 disc.
Note: Don’t forget to install both the Mac OS X system and application software.

For further assistance in software troubleshooting, go to Knowledge Base article:

- 58042: A flashing question mark appears when you start your Mac
- 88410: SMART: A Brief Description

Power, but No Video (Computer begins to power up, the fans and hard drive spin, the Caps Lock key lights up when pressed, but there is no startup chime or video.)

Note: Examine the display carefully. An image may be barely present on the screen, but with no backlight clearly illuminating the image. In this case, the system is working properly except for the backlight. Use the *Display: Dim Video* troubleshooting section to resolve this issue.

1. Reset the SMC (power manager) as described in “Resetting the System Management Controller (SMC)” under “Troubleshooting Tips and Tricks” in the previous section.
2. Try connecting an external display to check for intact video signal. If external video appears, check the system for any pending software or firmware updates and update accordingly.
3. Verify inverter cable and LVDS cable connections are seated properly and that the cables are not damaged.
4. Replace the display assembly.
5. Replace the logic board.

System shuts down intermittently

1. Disconnect all external peripherals and eject any ExpressCard.
2. Consult system.log for possible shutdown error codes using Console (in Utilities folder).

Shutdown Code	Potential Indication, Issue and/or Fix
3	Normal behavior... power button was pressed for more than four seconds to force shutdown.
-5	Normal behavior... regular shutdown
-60	Try charging battery.
-70	Replace top case.
-72	1) replace heatsink sensor 2) reapply thermal paste 3) replace heatsink
-74	1) swap battery for KGB battery 2) replace battery
-78	Charger circuit on logic board... 1) try swapping for KGB left I/O board... replace if necessary 2) replace logic board
-82	Test thermal sensor JST connectors for improper seating or damage. Replace thermal sensor(s). See <i>Thermal Sensor</i> take apart section.

3. Make sure a known-good fully charged battery is fully inserted. Check that the battery latch is fully engaged and functional. Check the battery connection to logic board.
4. Make a visual inspection of the battery connector in the battery bay. The battery connector should allow for some play to align to the battery terminals. Make sure all blades are visible and not bent. If damaged, replace the battery connector.
5. Make sure the system is not overheating, the air vents are clear, and the unit was not being used on a soft surface.
6. Make sure all feet are still on the bottom case. If not, order foot replacement kit.
7. Check that the fan cables are connected and the fans are operational.
8. Remove the battery and connect a known-good 85W power adapter and power cord or plug to a known-good power source. If the DC plug is properly seated, the LED should light up. If not, consult the *MagSafe power adapter* troubleshooting section.
9. Verify that all three thermal sensor connectors are well seated to the logic board and that there is no damage to any of the cables.
10. Run ASD diagnostics to determine if any of the thermal sensors are not functioning correctly. Replace any failing sensors. See chart below for correlation between error code and part.

Name	Location
TCOD, TCOP, TGOP, TGOT, TGOD, Th0H	Main logic board
TBOT	Main battery
TWOP	AirPort Extreme Card
Tm0P	Left I/O board

Ts0P	Top case
Th1H	Thermal sensor on heatsink
TG0H	Bottom case thermal sensor near right fan
Th2H	Bottom case thermal sensor near left fan

11. Verify that the left I/O board cable is securely connected and shows no signs of wear.
12. Try known-good left I/O board.
13. Check that the thermal material between the heat exchanger and logic board is in contact by unscrewing the logic board screws and gently pulling up on the left side of the board to verify resistance caused by adhesion of the thermal material. If not, reinstall new thermal material for the processor, system controller, and video chips (see Logic Board Take apart).
14. Replace the logic board.

System shuts down almost immediately after startup

1. Disconnect all external peripherals and eject any ExpressCard.
2. Make sure a known-good battery is fully inserted. Check battery charge and make sure that at least two LED charge indicators light up; otherwise connect the adapter. The adapter LED should light when plugged in. If not, consult the *MagSafe power adapter* section for further troubleshooting.
3. After charging for a while, if the battery does not seem to charge, or if it is charged up but quickly discharges, replace the battery. Verify with a known-good battery.
4. Check battery connection to logic board, and check wire attachment to connectors.
5. If just before the system shuts down, the sleep LED briefly comes on, check the three thermal sensor connections to the main logic board. They should be fully seated with no damage to the wiring. If any thermal sensor is damaged, replace it.
6. If a known-good battery does not charge, replace the left I/O board.
7. Replace the logic board.

Application Quits, Kernel Panic or other booting problems

1. If a specific application quits, replace the application. Verify that the application is compatible with OS X.
2. Reset PRAM. (After restart, hold down the Command-Option-P-R keys until you hear the startup chime at least one additional time after the initial startup chime).
3. Run Disk Utility from the Software Install and Restore DVD.
4. Reboot the system.
5. Run Apple Service Diagnostic (ASD) in loop mode (Control-L) for an extended time to test the memory. If the test finds bad memory, replace the DIMMs one at a time and test until all bad DIMMs are replaced with known-good modules.
6. Replace the logic board.

AirPort Extreme

Note: The AirPort Extreme card is separate from the Bluetooth module, the AirPort antenna is in the clutch barrel behind the gray plastic window, and the Bluetooth module and antenna are mounted underneath the top case.

AirPort Extreme card is not recognized

1. In Mac OS X, use Software Update in System Preferences or see the Apple Software Updates web page to make sure the latest version of AirPort Extreme software is installed.
2. Reset PRAM. (After restart, hold down the Command-Option-P-R keys until you hear the startup chime at least one additional time after the initial startup chime).
3. Open AirPort in System Preferences and make sure AirPort is on and Base Station is selected.
4. Reseat the AirPort Extreme card in its slot.
5. Remove and reinstall the AirPort Extreme software.
6. Replace with known-good AirPort Extreme card.
7. Replace left I/O board.
8. Replace the main logic board.

AirPort connection is slow

1. Move computer closer to the AirPort Base Station or other AirPort device.
2. Check the number of users trying to use AirPort in the area. Too many users may be accessing the network at the same time, causing heavy network traffic. To improve network connection speed, add additional AirPort Base Stations.
3. Check for other changes in the environment that may cause interference with the AirPort signal. For more information, consult these Knowledge Base articles: 58543: AirPort: Potential sources of interference, 307289: MacBook Air: Optimizing AirPort Performance while using Bluetooth, and 307296: MacBook Air: Optimize Wireless Communications when using an External Display
4. Use Software Update in System Preferences or see the Apple Software Updates web page to make sure the latest version of AirPort Extreme software is installed.
5. Restart the computer.
6. Check the AirPort Extreme antenna connection to the AirPort Extreme Card. Make sure each connector is securely connected and placed in the proper order.
7. Reseat the AirPort Extreme card in its slot.
8. Replace with known-good AirPort Extreme card.
9. Check AirPort Extreme antenna wires coming from clutch barrel for nicked insulator or crimped wire. If damaged, replace the display assembly.
10. Check the left I/O flex cable for proper seating on both the left I/O board and logic board.

-
11. Replace the left I/O board.
 12. Replace the main logic board.

Battery

Warranty Note: If the battery is determined to be the root cause of the customer issue, see Kbase article 500644: Portable Computer Battery Screening Process for Apple Service Providers to determine if the battery can be replaced under the one-year limited warranty.

Before troubleshooting battery-specific issues, make sure to check Software Update in the System Preferences or see the Apple Software Updates web page for battery-related software updates.

Battery will not pop up

1. Flip over the unit and slide the battery latches to their full extent.
2. If the battery does not pop up, use a small plastic flat-blade tool to pry up the battery around the battery latch. If the battery is swollen, replace the battery. See below.
3. Try a new battery.
4. Verify proper latch operation by exercising the latch. If it does not move smoothly or evenly, try disassembling the battery latch. Check that the spring held between the latch cover and the battery latch pin is intact.
5. Replace the bottom case.
6. If the latch does exercise correctly, verify that the customer is not installing the battery with excessive force or the body of the battery has not been deformed around its perimeter.

Warning: If the battery plastic housing has been damaged, or the two halves of the housing have separated, the battery is unsafe for use.

Note: If there is no sign of abuse (dents, scratch marks) replace the battery under warranty.

Swollen battery

1. Symptom(s):
 - The computer may not run off battery power alone
 - The computer wobbles and won't sit flat on a flat surface
 - The trackpad button is continually pressed and doesn't release (in this case, test by removing the battery to see if the trackpad button functionality returns).
 - A swollen battery can expand and cause the battery case to break open, exposing cells. Use care and common sense when handling a battery with exposed cells.
2. If the bulged battery will not release/come out of the unit, try removing the top case to help release the battery.
3. Replace the battery.

For more information and visual examples, consult Knowledge Base article 303922: MacBook, MacBook Pro (15-inch), or MacBook Pro (17-inch) with swollen battery.

The battery won't charge

1. Remove any externally connected peripherals.
2. Try a known-good power outlet.
3. Connect a known-good MagSafe 85W power adapter with power cord or plug. If the DC plug is properly inserted, the LED should light up. If not, troubleshoot the MagSafe connection and power adapter. If the LED is green, turn over the computer and press the battery button. The battery lights should glow green and stay on if the power adapter is operating correctly.
4. Try a known-good battery. If it charges, replace the battery. If doesn't charge, check the battery connector and its connection to the logic board.
5. Reset the SMC (power manager) as described in "Resetting the System Management Controller (SMC)" under "Troubleshooting Tips and Tricks" in the previous section.
6. Make sure the left I/O cable is firmly connected. Look for damaged insulation or wires.
7. Replace the battery connector assembly (requires removing the logic board).
8. Replace left I/O power cable.
9. Replace the left I/O board.
10. Replace logic board.

Battery won't charge completely

If the battery appears to stop charging between 95 and 99 percent, this is normal operation. Refer to Knowledge Base article 88344: Apple portable computer's battery does not show a full charge in Mac OS X.

Short battery life

Three categories to consider:

1. There is a system issue (not the battery).
 - If you have the customer's power adapter, plug it into a known good outlet and verify that it can charge the system. Also make sure it is the correct 85W adapter.
 - Plug a known good 85W adapter into a known good outlet. Verify that the DC connector is fully seated into the computer.
 - Check whether the customer's system is set up for heavy battery power use (AirPort on, optical media always in drive, Energy Savings set to Highest Performance, etc).
 - Use Activity Monitor to check for any runaway applications. Stop any runaway processes.
 - Test the computer with all third-party devices (printers, hubs, third-party keyboard or mouse) removed.
 - Reset the SMC (power manager) as described in "Resetting the System Management Controller (SMC)" under "Troubleshooting Tips and Tricks" in the previous section.
2. The battery needs calibration, or it is nearing the end of its useful life.
 - Calibration should be done when you first use the battery, and every few months after. It

allows the battery to properly calculate how much power is left in the battery.

- The battery is a consumable part. It can be charged and discharged only so many cycles before it becomes depleted and can no longer hold a charge.

Note: The battery calibration procedure is as follows:

- a. Plug in the power adapter and fully charge your battery until the light on the power adapter plug changes to green and the on-screen meter in the menu bar indicates that the battery is fully charged.
- b. Allow the battery to rest in the fully charged state for two hours or longer. You may use your computer during this time as long as the adapter is plugged in.
- c. Disconnect the power adapter with the computer on and start running it from the battery. You may use your computer during this time. When your battery gets low, you will see the low battery warning dialog on the screen.
- d. Continue to keep your computer turned on until it goes to sleep.

Note: Save all your work and close all applications when the battery gets low, before the system goes to sleep.

- e. Turn off the computer or allow it to sleep for five hours or longer.
- f. Connect the power adapter and leave it connected until the battery is fully recharged again.

3. The battery has a defect.

- Symptoms include, but are not limited to, a relatively new battery that will not charge at all, reports an “X” in the menu bar icon, or a status light on its case that will not go out. In the first two cases, the battery may need calibration—try this first. In addition, after troubleshooting at the system level, if it is demonstrated that the battery is causing abrupt shut-downs or goes to sleep without warning, the battery can be considered severely degraded and follow the criteria at the beginning of this section.

Useful Knowledge Base articles:

- 86440: Apple Portables: Battery life
- 86284: Calibrating your computer's battery for best performance
- 304301: MacBook and MacBook Pro: Battery not recognized after being fully drained

Bluetooth

Bluetooth system preference pane does not show up under hardware section of System Preferences

1. Check for software/firmware updates on the web.
2. Check the Bluetooth card flex cable. Make sure the cable is not damaged and is fully seated.
3. Check the Bluetooth flex connection to the trackpad flex.
4. Check the flex connection to the main logic board.

-
5. Replace the Bluetooth card.
 6. Replace the logic board.

Bluetooth card not recognized by other devices

1. Open Bluetooth in System Preferences and make sure that Discoverable is checked under the Settings tab.
2. Make sure the Bluetooth antenna is properly installed.
3. Check that the Bluetooth antenna is connected to Bluetooth card.
4. Replace with known-good Bluetooth card.
5. Replace logic board.

Display

Display latch not working

Note: As the display is being closed, two latch hooks in the top of the display housing should be magnetically pulled down through the slots in the top case and secured by the latch mechanism. When the latch button is pushed, the hook should release and retract into the display housing.

See *Latch Adjustment* chapter for more information on adjusting the latch mechanism.

If one or both of the latch hooks are broken, replace the display latch hook assembly.

When displaying a single color over the screen area, the LCD panel shows one or more pixels that are not properly lit

To determine whether or not the display has an acceptable number of pixel anomalies, follow the steps below:

1. Set the display image to one of the following colors: all-white display, all-red display, all-green display, or all-blue display. Knowledge Base article 112125: Service Diagnostics Matrix, has the LCD Tester Diagnostic Utility that will generate these patterns on the screen.
2. Using a jeweler's loupe, pocket microscope, or other magnifying device, identify and count each pixel anomaly:
 - Bright subpixel anomaly = subpixel that is always on
 - Dark subpixel anomaly = subpixel that is always off

Acceptable Number of Subpixel Anomalies

Bright	Up to 3
Dark	Up to 5
Combination	Up to 7

-
3. If the number of subpixel anomalies exceeds the acceptable number listed in the above chart, replace the display panel assembly.

Replace

Bright	4 or more
Dark	6 or more
Combination	8 or more

4. If the number of subpixel anomalies is acceptable, explain to the customer that the pixel anomalies are within specifications, and no repair is necessary.

Important: Do not release the specifications to customers. Instead, inform them that a certain number of subpixel anomalies are considered acceptable, and these factors apply to all manufacturers using LCD technology—not just Apple products.

When speaking with customers, please use the following explanation:

Active-matrix LCD technology uses rows and columns of addressable locations (pixels) that render text and images on screen. Each pixel location has three separate subpixels (red, green, and blue) that allow the image to be rendered in full color. Each subpixel has a corresponding transistor responsible for turning the subpixel on or off.

There are typically millions of these subpixels on an LCD display. For example, the LCD panel used in the Apple Cinema HD display is made up of 2.3 million pixels and 6.9 million red, green, and blue subpixels. Occasionally, a transistor does not work perfectly, which may result in the affected subpixel being turned on (bright) or turned off (dark). With the millions of subpixels on a display, it is quite possible to have a low number of faulty transistors on an LCD. Therefore, a certain number of subpixel anomalies are considered acceptable. Rejecting all but perfect LCD panels would significantly increase the retail price for products using LCD displays. These factors apply to all manufacturers using LCD technology—not just Apple products.

ExpressCard/34

ExpressCard will not insert into the ExpressCard slot

1. Make sure the ExpressCard is 34mm in width. The general ExpressCard standard does allow for 54mm cards which will not fit in this slot.
2. Make sure the ExpressCard is oriented right side up (cards are keyed and cannot be inserted upside down).
3. Verify that the ExpressCard is not warped or damaged in any way; if so, replace the card.
4. Try a different ExpressCard.
5. Carefully raise the ExpressCard slot cover and check for a foreign object inside the slot.
6. If the slot cover is preventing the card from being inserted, the door may be catching on the top of the ExpressCard mechanism. Adjust the position of ExpressCard cage on the left I/O

board by making sure the cage is closer to the main logic board.

7. Reseat the ExpressCard cage.
8. If the ExpressCard cage is damaged, replace it.
9. Replace the left I/O board.

ExpressCard does not mount to the desktop

1. Make sure the correct drivers are installed for that ExpressCard.
2. Check to see if a known-good ExpressCard works in this slot. The ExpressCard may be bad.
3. Check the left I/O Board flex cable connection to the logic board.
4. Try inserting the card without the ExpressCard cage installed on the left I/O board. If the card is recognized, reinstall the ExpressCard cage with the card in place to ensure the card cage properly aligns to the connector on the left I/O board.
5. Replace the left I/O flex cable.
6. Replace the left I/O board.
7. Replace the logic board.

Hard Drive

Internal hard drive will not initialize

1. Make sure the hard drive is a cable select drive set as a master (0).
2. Start up from the MacBook Pro Mac OS X install Disk 1 disc that came with the computer (hold down the "C" key during restart).
3. When the Installer opens, from the Installer menu, select Open Disk Utility.
4. If the hard drive is recognized, format it under the Erase tab.

To format a blank hard drive:

- Boot from the MacBook Pro Mac OS X Install Disc 1 which came with the system (hold down "C" key while booting).
 - Select the desired language.
 - Select Disk Utility, under the Utilities menu.
 - Click the Erase tab.
 - Select the hard drive in the Source pane.
 - Verify that Mac OS Extended (Journaled) is selected.
 - Click Erase.
5. Continue using the MacBook Pro Mac OS X Install Disc 1 to install the system software.
 6. Restart the computer and run Software Update and install updates. Continue to run Software Update until no more updates are listed.

Important: If the computer is under warranty and data recovery is required, refer to

Knowledge Base article 31077: Hard Drive Data Recovery & Warranty Implications for important information.

System boots to flashing question mark:

Refer to the previous *Flashing Question Mark* section for tools to troubleshoot this issue.

Internal hard drive not recognized:

1. Boot from the MacBook Pro Mac OS X Install Disc 1 which came with the system (hold down "C" key while booting).
2. If not the primary boot volume, use Apple System Profiler to check under 'Hardware: Serial-ATA' option to see if the system recognizes the hard drive hardware.
3. Check the SMART status. If the status is 'About to Fail' or 'Failing,' replace the hard drive.
4. Reseat the hard drive flex cable.
5. Check the hard drive flex cable for damaged connectors (a connector peeled off the flex cable, for example); if damaged, replace the hard drive flex cable.
6. If still not recognized, replace the hard drive.
7. Replace the logic board.
8. Reinstall system software using the MacBook Pro Mac OS X Install Disc 1.

Note: Don't forget to install both the Mac OS X system and application software.

Important: If the computer is under warranty and data recovery is required, refer to Knowledge Base article 31077: Hard Drive Data Recovery & Warranty Implications for important information.

Apple Remote

Remote won't communicate with system applications such as iTunes or iPhoto, or with the optical drive.

Make sure of the following when using the (infrared) Apple Remote:

- You are within 30 feet of the front of the computer.
 - You have an unobstructed line-of-sight to the front of the computer.
 - You are pointing the lens end of the Apple Remote directly at the front of the computer.
 - The computer is powered on and awake.
 - The "Disable remote control infrared receiver" check box in the Security pane of System Preferences is NOT checked.
1. Make sure the active application works with Apple Remote. Apple Remote uses Front Row, and from Front Row it can access DVD Player, iPhoto, iTunes, and QuickTime Player.
 2. Make sure the remote is paired with the computer. Access the System Preferences -> Security pane and check "Unpair" if available. Close the Security pane, and re-pair the Apple Remote. See Knowledge Base article 302545: Pairing your Apple Remote with your computer.

-
3. Use a digital camera to test your Apple Remote.

If you have a digital camera or DV camera with an LCD display, you can use it to see if your Apple Remote is emitting a signal. Infrared beams are invisible to the human eye, but most digital cameras and video cameras use Charged-Coupled Device (CCD) chips or image sensors that are sensitive to infrared light.

To use a camera to test your Apple Remote, follow these steps:

- Turn on your digital camera or DV camera and remove any lens cover.
 - Point your Apple Remote toward the display latch button.
 - Press and hold the Menu button on the remote while looking at your camera's LCD display.
 - If you see a faint blinking light coming from the Apple Remote in the camera's LCD, then the remote is working properly.
 - If you don't see any blinking light in the camera's LCD, replace the battery in your Apple Remote and then test it again with your computer.
4. Replace the Apple Remote battery. See Knowledge Base article 302543: How to replace the Apple Remote battery.
 5. Replace the Apple Remote.

Infrared Board

Note: Infrared transmission loses strength in daylight. If the remote control is being used near a bright window or outdoors, the system may not respond.

Supported applications do not respond to input from the remote control

1. Make sure "Disable remote control infrared receiver" check box is not checked.
2. If "Unpair" is available in the Security pane of System Preferences, another Apple Remote may be paired to the computer (pairing allows only one Apple Remote to control the computer). To delete a pairing between the remote and the MacBook Pro, click Unpair. (You may have to enter your Administrator password to make changes in the Security preference pane.)

For further instruction, consult Knowledge Base article 302545: Pairing your Apple Remote with your computer.

3. Perform the checks above under "Apple Remote" to verify that the Apple Remote is functioning correctly, and then retest.
4. Check that the infrared board cable is connected to the hard drive flex and infrared board.
5. Verify that the infrared sensor can be seen in Apple System Profiler. Open Apple System Profiler and check to see that IR Receiver appears under the USB Bus tab in the USB device section. If you don't see it, replace the infrared board and retest.
6. Replace the hard drive flex and retest.
7. Replace the logic board.

Built-in iSight Camera

The built-in camera is not recognized

1. Boot the MacBook Pro to the desktop and launch iChat AV. **Note:** You do not need to be connected to a network to use iChat AV to troubleshoot. Verify that the correct versions of Mac OS X and iChat AV are installed. Reinstall or update software as needed.
2. Open the iChat AV preferences and click on the 'Video' icon. Verify that the camera is recognized by the iChat AV software. Is the camera recognized?
3. Check the camera connection to main logic board. Try re-seating the connector.
4. Check the camera connection from the logic board to the camera board (in the display assembly). Try re-seating the connector.
5. Replace the display assembly.

Camera image quality poor

1. Verify that the lens assembly for the iSight camera is clean. Fingerprints and other contaminants can affect image quality. Clean the lens using a lint-free lens cleaning cloth being careful not to scratch the lens. Verify that there is sufficient lighting to produce a good quality image.
2. Lighting which is comparable to that found in a well-lit office will product a good quality image. If possible, avoid having a brightly lit background. Diffused lighting is preferred over direct lighting. Launch iChat AV and open the iChat AV preferences. Click on the 'Video' tab. Is the video quality acceptable?

Yes: The camera is functioning normally. The image quality problems may be caused by bandwidth limitations when using iChat over the internet. Instruct the customer to use the iChat AV connection doctor feature to verify that there is sufficient bandwidth to have a video iChat session without a significant degradation of image quality.

No: The camera may not be functioning normally. Continue troubleshooting.

3. Check the flex connections from camera to camera board in the display assembly. Try re-seating the connectors.
4. Replace display assembly and retest.

Camera recognized but no audio

1. Open the System Preferences window and click on Sound.
 - Verify that the built-in internal microphone has been selected as the sound input port.
 - Use the volume level meter to verify that the input volume settings are appropriate.
2. Launch iChat AV and open the iChat AV preferences. Click on the 'Video' icon. Speak into the microphone while monitoring the microphone level indicator. If line meter responds, it was a settings problem.
3. Reset PRAM. (After restart, hold down the Command-Option-P-R keys until you hear the

startup chime at least one additional time after the initial startup chime).

4. Check that the speaker/microphone connector is plugged in.
5. Check that the left I/O flex cable connector is properly seated on the logic board.
6. Replace the speaker assembly.
7. Replace the left I/O board.

The camera is recognized but the built-in microphone's audio quality is poor

1. Open the System Preferences window and click on Sound.
 - Verify that the internal microphone has been selected as the sound input port.
 - Use the volume level meter to verify that the input volume settings are appropriate.
2. Open iMovie and create a new project. Click on the Audio button and record a sound sample. If audio quality is fine, it was a settings problem.
3. Check that the speaker/microphone connector is plugged in.
4. Replace the speaker assembly.
5. Replace the left I/O board.

Keyboard

No response from keys on the keyboard

1. Remove any connected peripherals and eject any ExpressCard.
2. If only numbers show up, check if NUM lock (F6) is engaged. **Note:** This step does not apply to MacBook Pro (17-inch Early 2008).
3. Go to Apple System Profiler and look under the USB Bus tab in the USB device section. If you see Apple internal keyboard / trackpad, go to step 6.
4. Attach an external USB keyboard. If the external keyboard doesn't work, go to step 6.
5. Turn off the computer. Check the keyboard flex cable connection to the trackpad and the trackpad flex cable connection to the main logic board (also check connectors for damage).
6. Start up from the MacBook Pro Mac OS X Install 1 DVD that came with the computer (hold down the "C" key during restart, if possible) to verify that it is not a software problem.
7. Replace the keyboard.
8. Replace the top case.
9. Replace the logic board.

No keyboard illumination

1. Go to the Keyboard system preference pane and make sure the "Illuminate keyboard in low light conditions" check box is checked. Cover the left and right speaker grills with your hands. **Note:** The keyboard illumination is not bright enough to be seen in most well lit spaces. In

order to view the keys being illuminated, the ambient light needs to be dim.

2. Check the keyboard backlight flex cable connection to the top case flex cable.
3. Replace the keyboard.
4. Replace the top case.
5. Replace the left ALS board.
6. Replace the logic board.

Keyboard is partially illuminated.

1. Check the keyboard backlight cable connection to the top case flex.
2. Replace the keyboard.
3. Replace the top case.

Microphone

The microphone is not working

1. Check the Sound system preference pane and verify that the selection under the Input tab is built-in microphone.
2. Check the signal level and level meter and adjust the gain.
3. Reset PRAM. (After restart, hold down the Command-Option-P-R keys until you hear the startup chime at least one additional time after the initial startup chime).
4. If there is no sound output from the internal speaker nor is the microphone working, verify all cable connections.
5. Check the microphone connection to the left I/O board.
6. Check the left I/O flex cable connection to the logic board.
7. Replace the microphone module.
8. Replace the left I/O flex cable.
9. Replace the left I/O board.
10. Replace the logic board.

Modem (External)

Note: MacBook Pro does not have a built-in modem, but offers an optional external USB Modem.

No modem dial tone

1. Check that the correct modem is selected in the Network Port Configuration section of the Network system preferences.

-
2. Verify known-good analog (not digital) telephone line.
 3. Verify known-good RJ-11 telephone cable.
 4. Verify RJ-11 cable is not plugged into Ethernet port (should not be physically possible with this MacBook Pro).
 5. Verify RJ-11 telephone cable is firmly installed in the modem port.
 6. Inspect RJ-11 connector for pin damage. If damaged, replace modem.
 7. Open Apple System Profiler, and look for Apple External Modem in the USB Device Tree under the Hardware tab. If it does not appear, check the modem USB connection.
 8. Update the system software.
 9. Try a known-good Apple USB modem in all USB ports. If it does not work in either of the two left USB ports, replace the left I/O board. If it does not work in the right USB port, replace the logic board.

Modem does not respond (can hear dial tone)

1. Check that the correct modem is selected in the Network Port Configuration section of the Network system preferences.
2. Check that the modem application is properly configured.
3. Open Apple System Profiler, and under the Software tab look at Extensions. Check to see that the MotorolaSM56K and AppleI2SModem Family files are listed and loaded. If not, restart the system and check again. If still not visible, replace system software.
4. Open Apple System Profiler, and look for Apple External Modem in the USB Device Tree under the Hardware tab. If it does not appear, check the modem USB connection.
5. Replace the Apple USB Modem.
6. Replace the logic board.

Modem intermittently disconnects or low performance

1. Verify known-good RJ-11 telephone cable (for example, the retaining clip is not broken off) and check that it is firmly installed when used. If telephone cable is bad, replace it.
2. If the issue happens with only one particular phone line, but not another, the problem may be an issue with that phone line. Under bad line conditions, try setting the modem script to start with a slower connect rate such as "Apple Internal 56K Modem (v.34)."
3. If the customer indicates the system disconnects under very high CPU loads such as burning DVDs and/or working with video editing software such as Final Cut Pro, try connecting the modem without any application running and see how the modem performs. Use Knowledge Base article 106642: Mac OS X: Using Apple PPP Test Server to test the modem. If OK, suggest to the customer to use the modem with less applications running simultaneously.
4. Replace the Apple USB modem.
5. Replace the logic board.

Optical Drive

Optical drive not recognized

1. Make sure the optical drive is a cable select drive set as a slave (1).
2. Reset PRAM. (After restart, hold down the Command-Option-P-R keys until you hear the startup chime at least one additional time after the initial startup chime).
3. Make sure the optical drive flex cable is undamaged and properly installed. If damaged, replace the flex cable.
4. Replace the optical drive.

The optical drive does not accept CD or DVD discs (mechanical failure)

1. Verify that the media is not warped and is a standard 12 cm circular disc.
2. Check for a small (non-standard) disc or other foreign object stuck inside. Remove the optical drive from the system to extract a stuck disc. See Removing a stuck disk in the optical drive chapter of the take apart section.
3. Verify that the disc is pushed almost all the way into the slot.
4. Check that the optical drive flex cable is undamaged and properly installed. If damaged, try replacing the flex cable.
5. Replace the optical drive.

The optical drive does not eject CD or DVD discs

1. Verify that the disc is not in use by quitting any applications that may be using the disc.
2. Press and hold Media Eject key at top right corner of keyboard. If that does not work, hold down Function (fn) key then Media Eject key. If that does not work, hold down Function (fn) key and Media Eject key simultaneously.
3. Drag the disc icon to trash, or select it and press Command-E.
4. Choose Restart from Apple menu while holding down trackpad button during startup.
5. Check the optical drive flex cable for proper connection to the logic board.
6. Reseat the optical drive mechanism. Make sure the drive is oriented toward the back of the computer, and that all four corners are seated, so that the drive sits flat in its bay.
7. Replace the optical drive.

The disc icon does not show up on the desktop, or a dialog box appears to initialize the disc when inserting a read-only disc

1. Verify that the correct type of disc is being used.
2. Use the Software Update system preference pane to check for updated firmware.
3. Try cleaning the disc. If it is dirty or scratched, it may not mount.

-
4. Try a different disc.
 5. Replace the optical drive cable.
 6. Replace the optical drive.

Difficulty writing to optical media

1. Verify that the correct type of disc is being used.
2. Try a different brand or speed of CD-R disc.

Note: Some brands of 24x or 32x CD-R media may not work with the SuperDrive.

Note: There are two factors in the ability for the optical drive to write to media.

- First, there are varying qualities of blank optical media. Some media are made to such low specifications that the ability for the drive to write to it is marginal. There are variations in optical media even under the same brand. Some brands source their optical media from a variety of manufacturers, so there may be variations in the quality.
 - Second, an optical drive that supports writing to a CD-R/RW or DVD-R/RW disc requires a special writing algorithm for discs from different disc manufacturers. There are hundreds of disc manufacturers, it is impossible to implement writing algorithms for each disc manufacturer. Usually, drive manufacturers implement special writing algorithms for discs from major disc manufacturers. For discs that are not supported by the drive with special writing algorithms, the drive will use a generic writing algorithm to write the disc. In this case, the writability and readability may not be optimal.
3. Use the Software Update system preference pane to check for updated drivers or firmware.
 4. Replace the optical drive flex cable.
 5. Replace the optical drive.

Ports

A USB port is not recognizing devices

1. Shut down the computer; then press the power button to start the computer.
2. Use Software Update system preferences to verify that the latest software is installed.
3. Test the ports with a known-good Apple keyboard or mouse.
4. Use Apple System Profiler to verify that the computer is recognizing the bus.
5. If a left port is not recognized, check the left I/O flex cable's condition and connection.
6. If the left I/O flex cable is intact and well-seated, and a left USB port is still not recognized, replace the left I/O board.
7. If the right USB port is not recognized, replace the main logic board.

A USB device not recognized by computer

Note: If you are trying to use a serial device with a USB/Serial adapter, check with the manufacturer of the adapter for compatibility.

1. Shut down the computer; then press the power button to start the computer.
2. Verify that the current driver for the device is installed.
3. If the device is a camera, turn on the camera only after initiating the download with the camera application.
4. Try the other USB port.
5. Try a different USB device on same port.
6. Eliminate any device chains by plugging in only one peripheral.
7. Test the USB ports with a known-good Apple USB keyboard or mouse.
8. If a left port is not recognized, check the left I/O board flex cable and connections.
9. If the left I/O flex cable is intact and well-seated, and a left USB port is still not recognized, replace the left I/O board.
10. If the right USB port is not recognized, replace the main logic board.

A FireWire port is not recognizing devices

1. Test the FireWire port by connecting to another computer using FireWire Target Disk Mode. Refer to Knowledge Base article 58583: How to Use FireWire Target Disk Mode.
2. Verify that the correct drivers are properly installed for third party devices, if needed.
3. Make sure the FireWire cable is firmly attached.
4. Try a known-good FireWire cable.
5. If the device is self-powered, make sure that the power supply is connected and the device's LED indicates it is getting power.
6. Replace the logic board.

MagSafe Power Adapter

The power adapter LED does not turn on

1. Confirm the power adapter is connected to a known-good outlet.
2. Try replacing the AC plug or AC power cord. If the adapter works, replace the plug or cord.
3. Check if pins are missing or bent. If so, replace the power adapter.
 - Check the pins in the power adapter's DC plug for pins that are stuck down.
 - If pins are stuck down, check for debris blocking one or more pins. Carefully clear the pins with metal tweezers. If necessary, clean the pins as described below.
 - If the pins appear OK, but the LED on the MagSafe connector does not light up, clean

the pins as directed in Kbase article 303240: Use and cleaning of power adapter with MagSafe connector.

4. Remove the battery and connect the power adapter. If the adapter turns on and boots the system, replace the logic board.
5. Remove the battery and connect the power adapter. If the adapter turns on and boots the system, replace the logic board.

Sound

No sound is audible but the Speakers section of the Sound system preference pane indicates an external device is plugged in (to the headphone jack or USB ports)

1. If there is nothing plugged into the headphone jack or USB ports, the Output tab of the Sound system preference pane should be set to the internal speakers.
2. If not, and if nothing is plugged in, try plugging in headphones or external speakers. Restart the computer. Remove the device.
3. Reset PRAM. (After restart, hold down the Command-Option-P-R keys until you hear the startup chime at least one additional time after the initial startup chime).
4. If the system continues to indicate a phantom device is plugged into the system, replace the left I/O board.
5. Replace the logic board.

No sound from speaker(s)

1. Use Software Update to verify that the latest audio update has been installed.
2. Press F10 (with the fn key pressed and then not pressed) to verify that mute mode is not enabled.
3. Press F11 or F12 (with the fn key pressed and not pressed) to check the volume setting.
4. Verify that no external speakers or headphones are plugged in.
5. Check the speakers tab on the Sound control panel to confirm that the software is correctly detecting that there are no external speakers or headphones connected. If so, use the previous troubleshooting procedure.
6. Shut down the computer and restart.
7. Reset PRAM. (After restart, hold down the Command-Option-P-R keys until you hear the startup chime at least one additional time after the initial startup chime).
8. Verify that the speaker cable is properly connected to the left I/O board.
9. Check the speaker cable. Verify left and right cable connections.
10. Verify sound output with known-good headphones or external speakers. If audio is heard, replace the speaker assembly.

-
11. Replace the left I/O flex cable.
 12. Replace the left I/O board.
 13. Replace the logic board.

Distorted sound from speakers

1. Verify that the sound quality is normal with known-good external speakers/headphones. If the sound quality is normal, check the speaker wire and connections.
2. In the Sound system preference pane, check the balance.
3. Compare the same sound and same settings with two different units to make sure that sound is actually distorted. If abnormal, replace the speaker assembly.
4. Check the speaker wire. If damaged, replace the speaker assembly.
5. Replace the left I/O flex cable.
6. Replace the left I/O board.
7. Replace the logic board.

Trackpad

The cursor does not move when you are using the trackpad

1. Verify that no USB device is connected.
2. Boot from the Software Install and Restore DVD to verify that the issue is not software related. If the trackpad works, restore the system software.
3. Reset the SMC (power manager) as described in “Resetting the System Management Controller (SMC)” under “Troubleshooting Tips and Tricks” in the previous section.
4. Check the trackpad flex cable connection to the logic board.
5. Replace the top case.
6. Replace the logic board.

The cursor intermittently stalls or moves erratically

Notes:

- The user must touch with the surface of the trackpad with only one finger at a time and point directly down on the trackpad surface.
- When running Apple Hardware Test or Apple Service Diagnostic, the trackpad will respond in very small movements of the cursor. This behavior is normal.
- When using an AC power adapter, you may need to have a three prong ground to eliminate noise coming from the AC outlet. If a grounding plug is not available, instruct the customer to have their palms touching the top case while using the trackpad.

1. Clean the trackpad surface (with the computer off) using a non-static-inducing material.

-
2. Shut down the system, then press the power button to start the computer.
 3. Reset the SMC (power manager) as described in “Resetting the System Management Controller (SMC)” under “Troubleshooting Tips and Tricks” in the previous section.
 4. Make sure the power adapter is connected to a known-good outlet using the AC power cord, not the duckhead. If the intermittent behavior goes away, recommend using the AC cord to provide a grounding path for static.
 5. Place the MacBook Pro Mac OS X Install 1 Disc in the optical disc drive, press the start button and hold down the “C” key. Check the cursor movement, to see if the problem is software.
 6. Check the trackpad flex cable connection to the logic board.
 7. Replace the top case.
 8. Replace the logic board.

Video

No video, but computer appears to operate correctly

See *Power, but No Video* section under the Startup section at the beginning of this chapter.

Dim display, but computer appears to operate correctly

1. Remove any connected peripherals.
2. Make sure the F1 key is not stuck down.
3. Press the F2 key (with the fn key pressed and not pressed) to increase the screen brightness.
4. Open Display system preference panel and check brightness. If works, replace keyboard.
5. Shut down the computer and restart.
6. Reset PRAM. (After restart, hold down the Command-Option-P-R keys until you hear the startup chime at least one additional time after the initial startup chime).
7. Try connecting an external display to check for intact video signal. If no external video appears, skip to step 10 below. Otherwise proceed to next step.
8. Check connection of the inverter cable to the main logic board.
9. Replace the display assembly.
10. Replace logic board.

Computer appears to work, but there is no video on an external device connected to the S-video/Composite port of the optional DVI to Video Adapter

1. The device must be connected to the S-video/composite port while the MacBook Pro is sleeping or off for the device to be recognized.
2. Verify that the test monitor being used is a known-good device supported by this computer.

-
3. Try a different DVI-to-Video Adapter.
 4. Replace the logic board.

No video on external VGA device connected to the external monitor (DVI) port

5. Verify that the test monitor being used is a known-good device supported by this computer.
6. Try a different DVI-to-VGA adapter cable.
7. Restart the computer and test again.
8. Replace the logic board.

Display has repetitive patterns or shifting color pattern

1. Check for the latest system software update.
2. Check that the LVDS connection is fully seated on the logic board.
3. Hook up an external display. If the external video displays the mirrored image correctly, replace the display assembly.
4. Replace the logic board.

Display has permanent vertical or horizontal lines.

1. Check for the latest System software update
2. Check that the LVDS connection is fully seated on the logic board.
3. Hook up an external display. If the external video displays the mirrored image correctly, replace the display assembly.
4. Replace the logic board.

Miscellaneous Symptoms

The Date and Time settings reset repeatedly

Note: Resetting the power manager and/or PRAM resets the date and time. The MacBook Pro uses a non-rechargeable lithium battery.

1. Do a backup battery test:
 - Set the date and time.
 - Perform a Shut Down from the Apple menu.
 - Remove the main battery and disconnect the power adapter for 10 minutes.
 - Connect the power adapter, insert the battery, and power on the computer.
 - If the date and time were lost the backup battery may be dead or discharged.
 - Remove main battery from the unit and leave it plugged in for at least 5 hours.
2. Replace the backup battery.
3. Replace the logic board.

Feet came off the bottom case

Replace the missing foot or feet.

Sleep LED does not come on when lid is closed

1. Put the computer to sleep using the menu option. If the sleep LED goes on, the computer is not detecting a closed display. If the LED does not go on, skip to step 3.
2. Place a magnet over the sleep sensor board in the top case. If the system goes to sleep, replace the magnet in the display housing.
3. Check that the sleep sensor in the top case is plugged in.
4. Check that the sleep LED is plugged into the logic board.
5. Connect a USB mouse. Short the power on pads on the logic board to boot the system and use the mouse to put the system to sleep from the menu. Measure the voltage at the LED connector. If power is present, replace the bottom case.
6. Replace the logic board.

Unit unusually hot

This computer runs hotter than previous models. However, the normal operating temperature is well within national and international safety standards. Nevertheless, customers may be concerned about the unit overheating. To prevent an unneeded repair, you can compare a customer's computer to a running model, if available, at your repair site.

1. Verify that the customer uses the computer while it is placed on a flat, hard surface.
2. Verify that the computer is hotter than expected for normal operation. If possible, compare how hot the computer case feels with how hot the case of a running display model feels.
3. If the computer is running at a temperature comparable to the test model, refer the customer Knowledge Base article 30612: Apple Portables: Operating Temperature
4. Use Activity Monitor to check for runaway applications.
5. Check the processor speed.
6. Is the processor speed running at the setting the customer set?

Yes: Continue with the next step.

No: The computer could be overheating. The operating system will automatically reduce the processor speed if the computer starts to get too hot. Continue with the next step.

7. Check for a failed fan.
8. Can you hear the fan running?

Yes: Continue with the next step.

No: This computer has only one fan. If the unit feels too hot and you do not hear a fan running or cannot feel the air venting over the top of the keyboard, the fan may have failed. Proceed to the Take Apart procedure for replacing the fan.

-
9. Check for misplaced or inadequate thermal grease.

Each processor chip should have .01 to .12 cc (one-third of a single syringe) of grease on it. It should look completely covered. See the Heatsink chapter of the Take Apart section for complete details.

10. Is the thermal grease applied in the right places and in the right amount, according to the service manual?

Yes: You have eliminated all the immediately known potential causes of an unusually hot unit. Proceed to the Systematic Fault Isolation step of the troubleshooting flowchart.

No: Apply the thermal grease correctly, according to the instructions in the service manual then proceed to the Verify Repair step of the troubleshooting flowchart.

For more information on the operating temperature of Apple portable computers, see Knowledge Base article 30612: Apple Portables: Operating Temperature.



Architecture

The architecture of the MacBook Pro is based on an Intel microprocessor and two integrated circuits (ICs): the North Bridge memory controller and the South Bridge I/O controller, connected to each other by a Direct Media Interface (DMI) bus. The North Bridge IC provides the bridging functionality among the processor, the memory system, the DMI bus, and the 16-lane PCI Express bus to the graphics controller. The South Bridge IC supports these components:

- Ultra ATA/100 bus for the optical drive (running at UATA/66)
- A 1.5 Gbps Serial ATA (SATA) bus for the hard disk drive
- 1-lane PCI Express link for the AirPort Extreme module, 1 for Ethernet, and 1 for ExpressCard
- SPI bus, direct memory access bus to the boot ROM
- USB 2.0 controller, which in turn supports the Bluetooth module, IR receiver, built-in iSight camera, built-in trackpad and keyboard, ExpressCard 34 mm slot, and 2 USB 2.0 ports
- Channel to the audio subsystem
- 33MHz, 32-bit internal PCI bus to the FireWire 400 (1394a) and FireWire 800 (1394b)
- Direct Media Interface (DMI) bus

Figure 1 provides a simplified block diagram of the North Bridge and South Bridge ICs and the buses that connect them together.

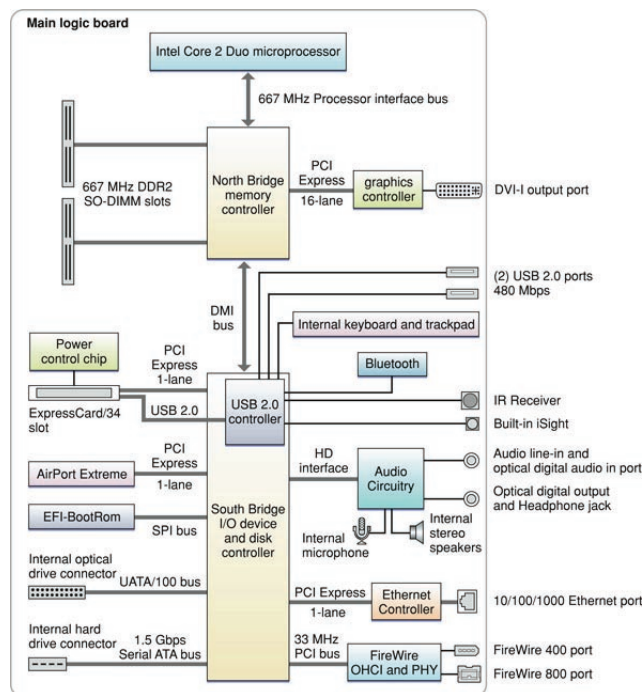

Apple Service Source



Views

MacBook Pro 17-inch
(original, Core 2 Duo, 2.4 GHz,
Late 2007 CTO, and Early 2008)

MacBook Pro (17-inch original) Exploded View

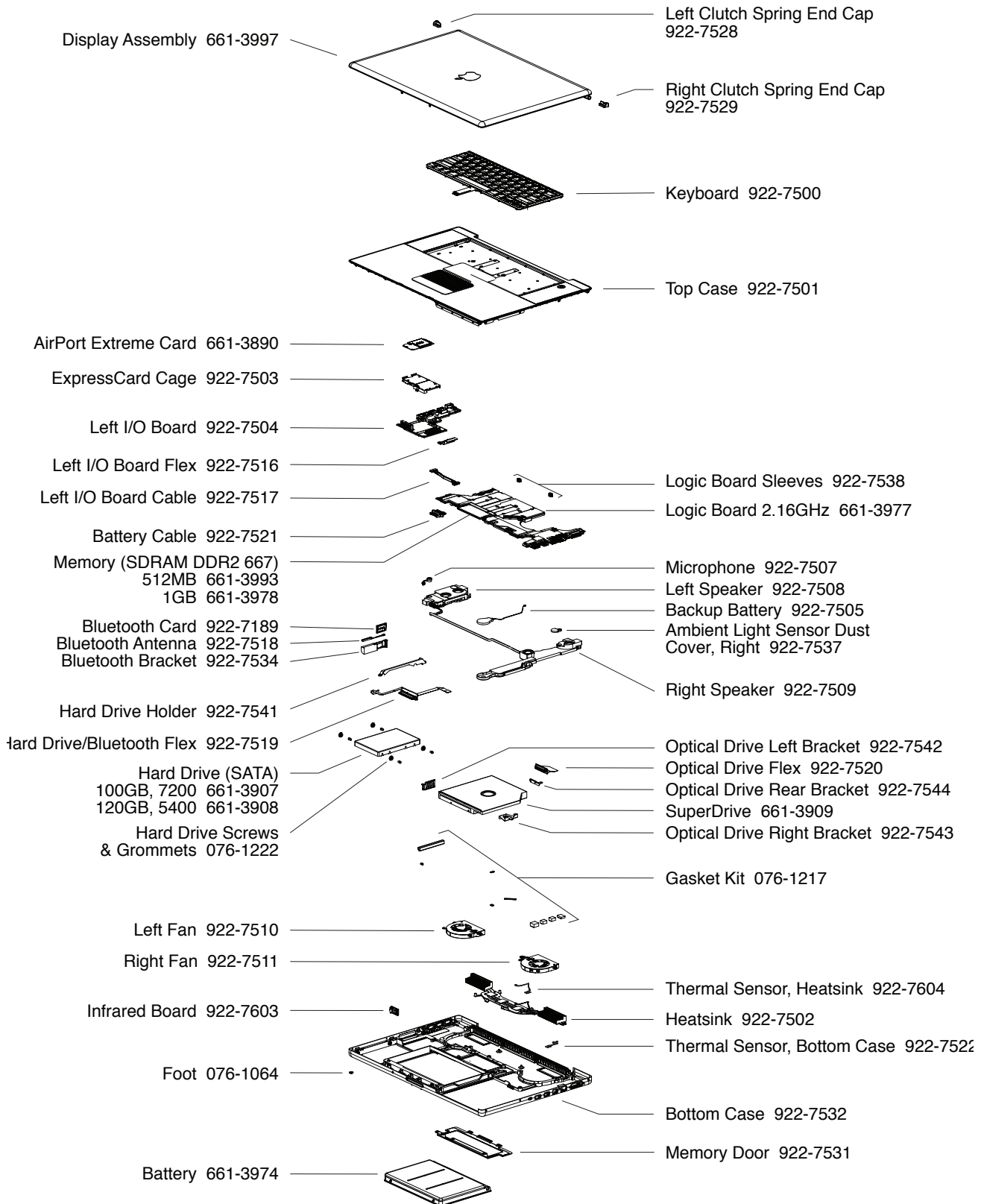

MacBook Pro (17-inch Core 2 Duo) Exploded View

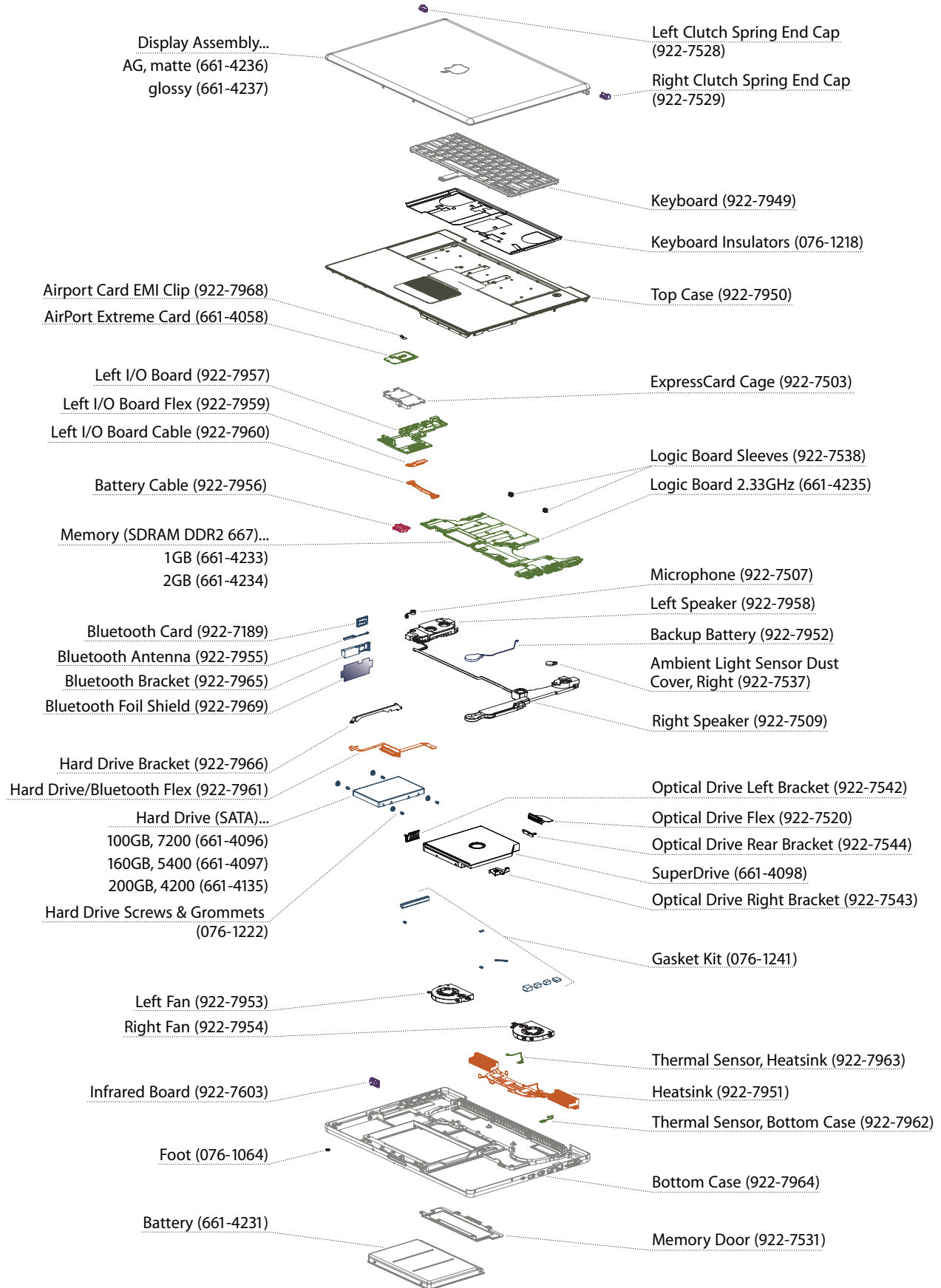

MacBook Pro (17-inch 2.4GHz) Exploded View

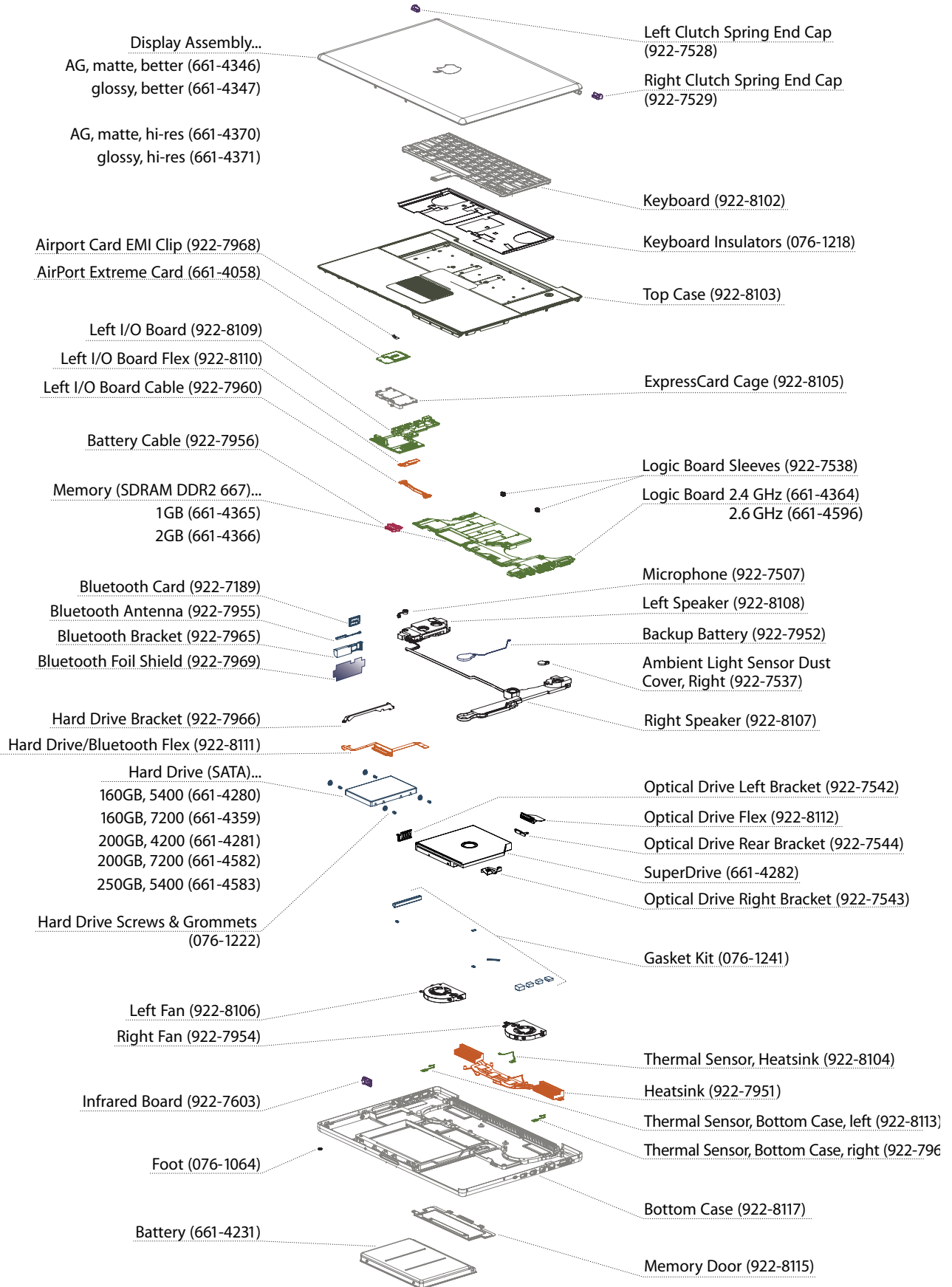

MacBook Pro (17-inch Early 2008) Exploded View

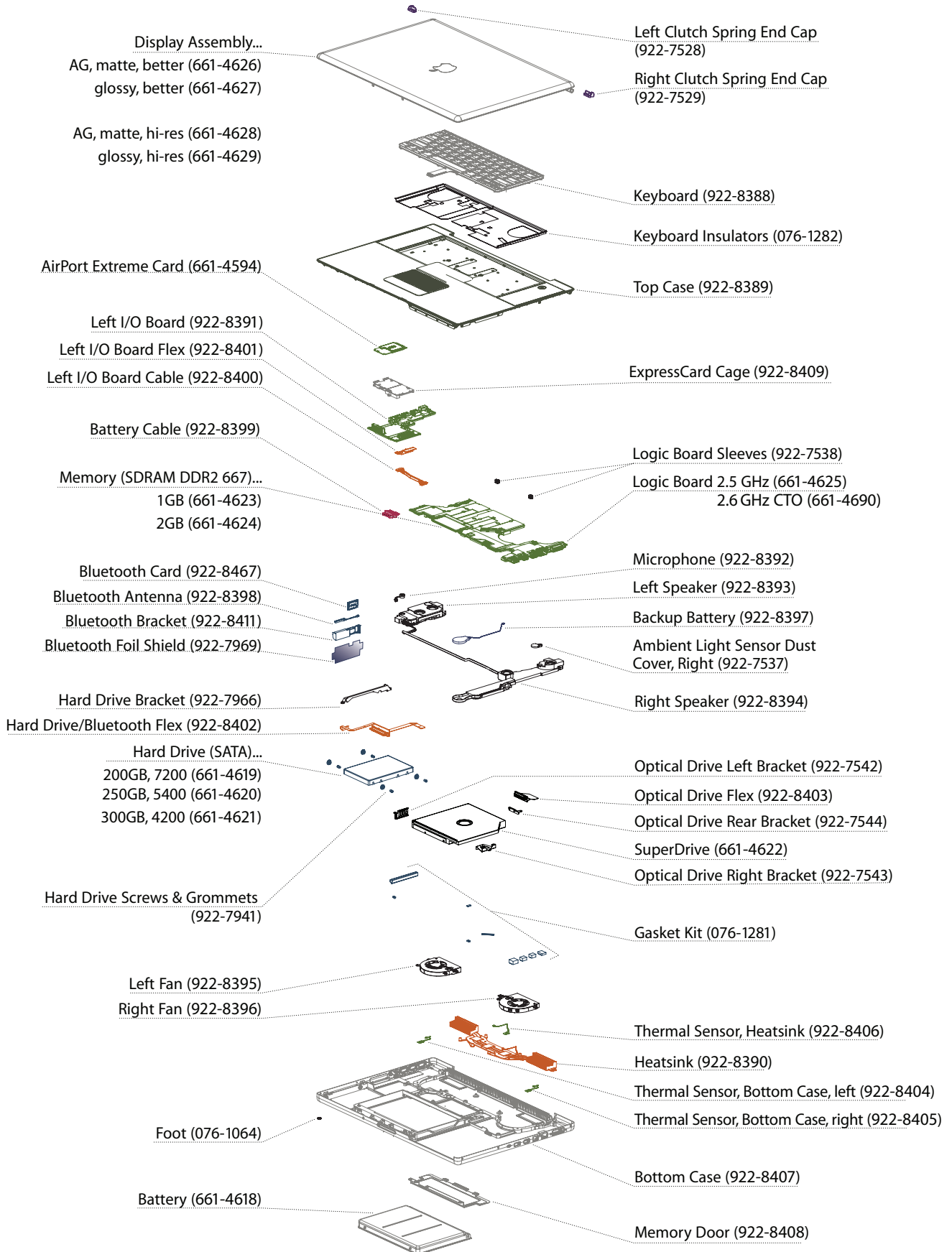





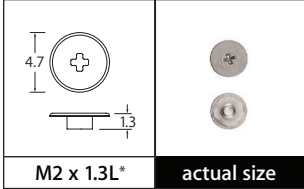
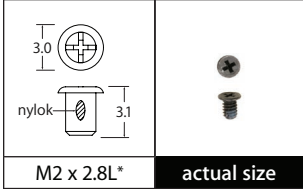
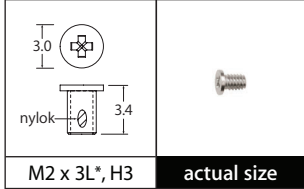
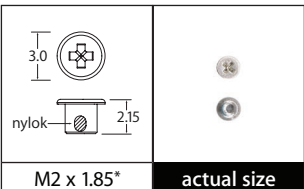
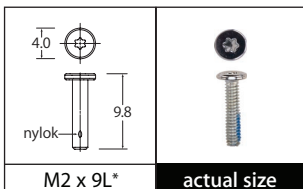
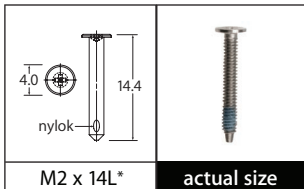
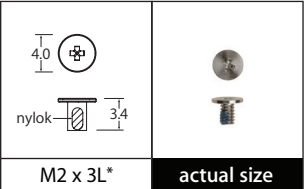
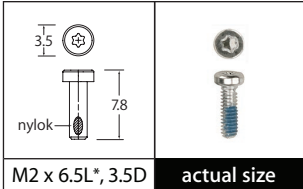
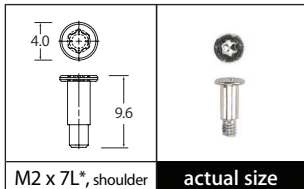
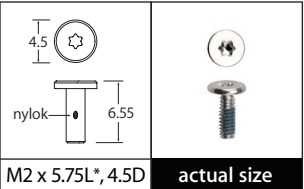
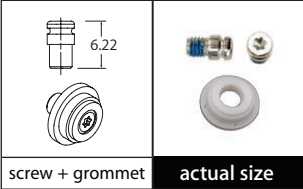
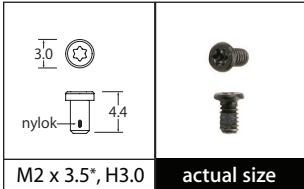



Screw Chart

<p>922-5838 Phillips</p>  <p>M2 x 1.3L* actual size</p> <p>keyboard, ExpressCard cage</p>	<p>922-6090 Phillips</p>  <p>M2 x 2.8L* actual size</p> <p>ExpressCard cage</p>	<p>922-6091 Phillips</p>  <p>M2 x 3L*, H3 actual size</p> <p>bottom case (left, right, back)</p>
<p>922-6488 Phillips #0</p>  <p>M2 x 1.85L* actual size</p> <p>optical drive brackets</p>	<p>922-7305 Torx T6</p>  <p>M2 x 9L* actual size</p> <p>under RAM door to keyboard, left and right clutches</p>	<p>922-7306 Torx T6</p>  <p>M2 x 14L* actual size</p> <p>bottom / top case</p>
<p>922-7309 Phillips</p>  <p>M2 x 3L* actual size</p> <p>battery well to top case, RAM door to top case</p>	<p>922-7524 Phillips #0</p>  <p>M2 x 6.5L*, 3.5D actual size</p> <p>fans, left speaker, logic board, left and right clutches</p>	<p>922-7525 Torx T6</p>  <p>M2 x 7L*, shoulder actual size</p> <p>battery cable connector</p>
<p>922-7606 Torx T6</p>  <p>M2 x 5.75L*, 4.5D actual size</p> <p>logic board, hard drive bracket</p>	<p>922-7610 Phillips</p>  <p>screw + grommet actual size</p> <p>hard drive screw + grommet</p>	<p>922-7941 Torx T6</p>  <p>M2 x 3.5*, H3.0 actual size</p> <p>Airport card, optical drive, ALS, infrared board, left I/O board</p>

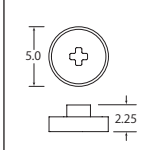
*This screw specification is thread and shank only. See CAD diagram above it for full screw length (including head).

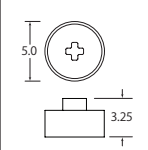

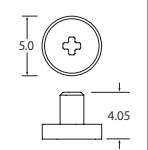
Screw Chart

922-8145	Phillips	922-8146	Phillips	922-8217	Phillips
					
M2 x 1, 1.25 head*	actual size	M2 x 1, 2.25 head*	actual size	M2 x 2.8, 1.25 head*	actual size
ExpressCard cage		ExpressCard cage		ExpressCard cage	

*This screw specification is thread and shank only. See CAD diagram above it for full screw length (including head).