



MacBook Air

January 30, 2008

 Apple Inc.

© 2008 Apple Inc. All rights reserved.

Under the copyright laws, this document may not be copied, in whole or in part, without the written consent of Apple.

Every effort has been made to ensure that the information in this document is accurate. Apple is not responsible for printing or clerical errors.

Apple
1 Infinite Loop
Cupertino, CA 95014-2084
USA
+ 1 408 996 1010
www.apple.com

Apple, the Apple logo, Mac, and Macintosh are trademarks of Apple Inc., registered in the U.S. and other countries.

MacBook Air

Contents

Basics

General Information	7
Product View	7
Overview	7
Main Service and Feature Differences of This Model	8
Quick Tour	10
Using the Trackpad and Keyboard	11
New Parts and Procedures	13
General Module Notes	17
Support Tools	17
Tools	18

Take Apart

Bottom Case	21
Removal Procedure	22
Serial Number Transfer Instructions	24
Reassembly Procedure	25
Battery	28
Removal Procedure	29
Reassembly Procedure	31
AirPort/BlueTooth Card	33
Removal Procedure	34
Reassembly Procedure	35
Speaker Assembly	37
Removal Procedure	38
Reassembly Procedure	41
Port Hatch Assembly	43
Procedure	44
Replacement Notes	45
MagSafe Assembly	46

Hard Drive	49
Removal Procedure	50
Replacement Notes	58
Thermal Module	59
Removal Procedure	60
Replacing the Thermal Paste	62
Reassembly Procedure	65
Logic Board	68
Removal Procedure	69
Reassembly Procedure	70
Thermal Module and Logic Board Combined	72
Removal Procedure	73
Reassembly Procedure	74
Display Assembly	75
Removal Procedure	76
Reassembly Procedure	78
Audio Flex Cable	80
Input Devices (IPD) Board Flex Cable	84
Airport/Bluetooth Card Flex Cable	87
Top Case with Keyboard	90
Anatomy of the top case	91
 Additional Procedures	
Replacing Keycaps	93
Preliminary Steps	93
Part Location	93
Procedure	94
 Troubleshooting	
General Information	110
How to Use the Symptom Charts	110
Wire and Flex Cables	110
Hardware Diagnostics	111
Sharing Discs with Remote Disc	113
Reinstalling software using Remote Install Mac OS X	115
Reinstalling software using the MacBook Air SuperDrive	116
Troubleshooting Tips and Tricks	116

MacBook Air Firmware Updates	118
Software Troubleshooting Tips and Tools	118
MacBook Air 45W MagSafe Power Adapter Compatibility	120

Troubleshooting Steps 122

Hardware Symptoms 125

How to Use the Symptom Charts	125
Startup	125
Battery	130
Bluetooth	134
Display	134
Hard Drive	135
Apple Remote	136
Infrared Receiver	137
Built-in Camera	138
Keyboard	139
Microphone	140
Modem (External)	140
MagSafe Power Adapter	142
Sound	143
Trackpad	144
Video	145
Miscellaneous Symptoms	147

Block Diagram 149

Views

Exploded Views 152

Screw Maps 153



Basics

MacBook Air



General Information

Product View



Overview

At only three pounds, the MacBook Air is the most mobile Macintosh yet. Its sleek, new, ultra-thin enclosure streamlines it for portability while its features offer a completely wireless experience.

Components in this system are smaller and more integrated than previous Macintosh portables; thus, a watchmaker's finesse is crucial when handling repairs. Likewise, the MacBook Air's new system architecture requires troubleshooting methodology specific to its design.

Because there are fewer parts, repair can seem deceptively simple. Pay close attention to warnings and cautions throughout the procedures in this manual to avoid repair issues.

Main Service and Feature Differences of This Model

- **Microprocessor:** 1.6 GHz Intel Core 2 Duo; optional 1.8 GHz available configured to order (CTO)
- **On-Chip L2 cache:** 4 MB shared by two cores
- **RAM:** 2 GB DDR2 soldered on logic board (not upgradable)
- **Hard drive:** 80GB PATA, 4200 rpm (1.8 in.); optional CTO 64GB PATA Solid State Drive (SSD)
- **Graphics:** Integrated Intel GMA X3100 (GM965 Express chip set), uses 144 MB system memory
- **Display:** 13.3-inch glossy 1280 x 800dpi, LED Backlit display
- **Video:** Built-in iSight camera; new micro-DVI port supports DVI, VGA, S-video and composite
- **Audio (In):** Built-in omnidirectional microphone, no input/audio line in
- **Audio (Out):** Built-in mono-speaker; analog audio output /headphone out
- **Wireless:** Built-in AirPort Extreme Wi-Fi (802.11n); built-in Bluetooth 2.1 + EDR
- **Keyboard:** Built-in full-size backlit keyboard with ambient light sensor
- **Trackpad:** Solid-state scrolling trackpad for precise cursor control; supports two-finger scrolling, tap, double-tap, drag, pinch, swipe, and rotate capabilities

Included standard with the MacBook Air:

- **45W MagSafe Power Adapter** — While it has the same MagSafe interface as all Intel-based notebooks, the adapter's DC plug is more streamlined to fit under the curved bottom case.



- **Two Micro-DVI adapters** — Micro-DVI to VGA and Micro-DVI to DVI adapters are included. Also, a Micro-DVI to Video (composite and S-video) adapter is available as a standalone kit.



- **A cleaning cloth**

Standalone accessories

Along with the Micro-DVI to Video adapter, other standalone options for the MacBook Air include:

- **MacBook Air SuperDrive** – An external USB slot-loading SuperDrive, solely bus-powered, works only with MacBook Air, directly connected to the USB port. It will not function through a hub.



- **USB Ethernet Adapter** – Allows connection to an Ethernet network. While compatible only with MacBook Air, the adapter comes in an enclosure similar to the Apple USB modem. You can differentiate between them by inspecting the ports: the USB Ethernet Adapter uses an RJ-45 connector with eight contacts, and the USB Modem uses an RJ-11 connector with two contacts.



- **MagSafe Airline Adapter** – This product is a revision of today's Airline Adapter, utilizing the MacBook Air MagSafe connector, which works with all other MagSafe notebook computers.

For more product details go to www.apple.com/MacBookAir

Quick Tour

Following is a quick tour of major features and important repair steps when servicing a MacBook Air. Please see the specific repair sections to obtain full details on servicing that part.

Basic features

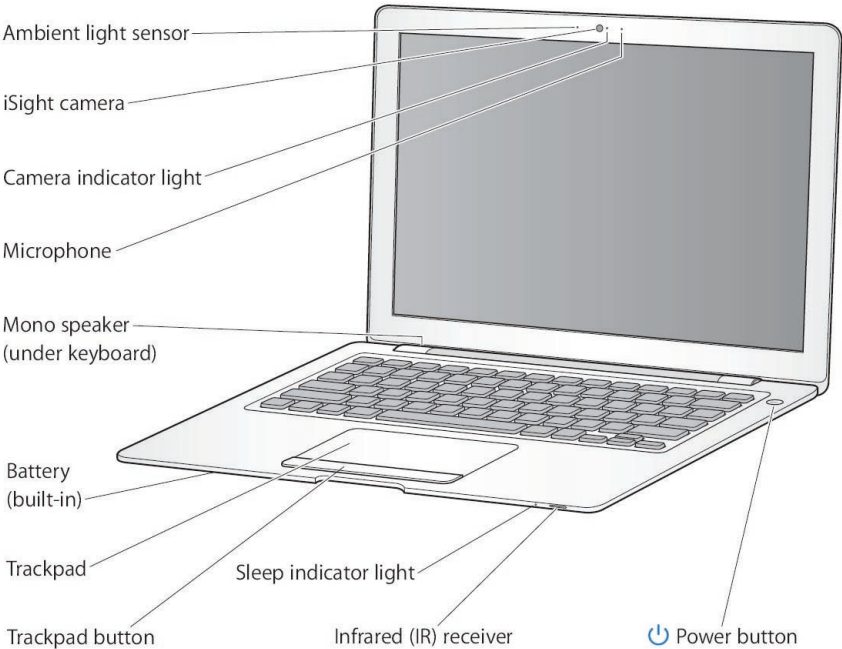

Ports

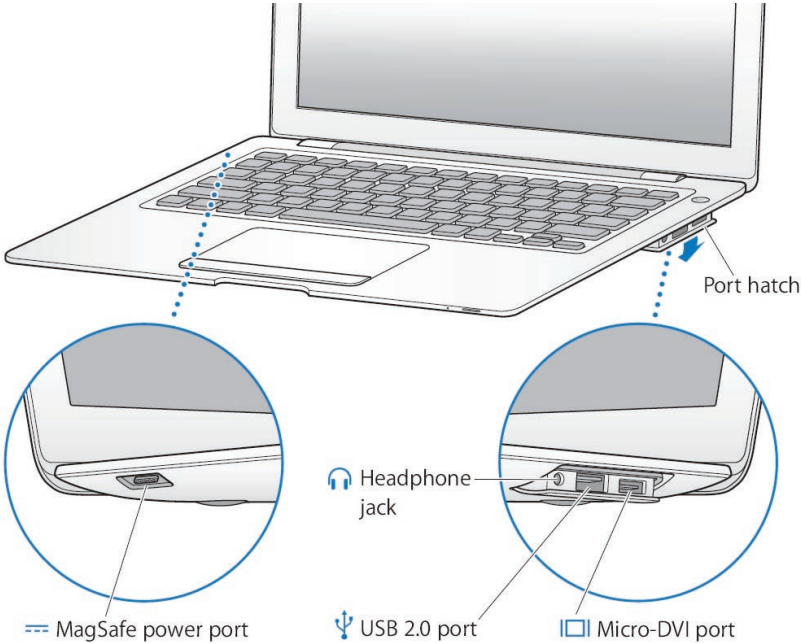

Using the Trackpad and Keyboard

Use the trackpad to move the pointer and to scroll, tap, double-tap, and drag. How far the pointer moves on screen is affected by how quickly you move your finger across the trackpad. To move the pointer a short distance, move your finger slowly across the trackpad; the faster you move your finger, the farther the pointer moves. To fine-tune the tracking speed and set other trackpad options, choose Apple > System Preferences, click Keyboard & Mouse, and then click Trackpad.

Useful trackpad tips and shortcuts

- *Forward deleting* deletes characters to the right of the insertion point. Pressing the **Delete** key deletes characters to the left of the insertion point.

To forward delete, hold down the Function (fn) key while you press the Delete key.

- *Secondary clicking* or “right-clicking” lets you access shortcut menu commands.

To secondary click, place two fingers on the trackpad while clicking the trackpad button. If Tap to Click is enabled, just tap two fingers on the trackpad.

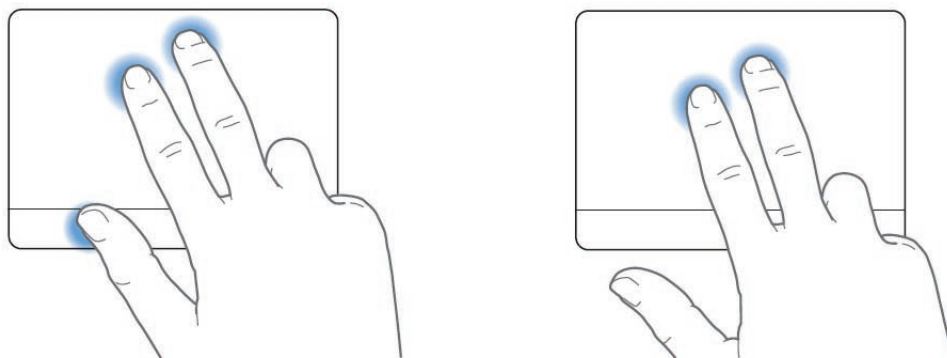

You can also secondary click by holding down the Control key while you click.

- *Two-finger scrolling* lets you drag to scroll quickly up, down, or sideways in the active window. This option is on by default.

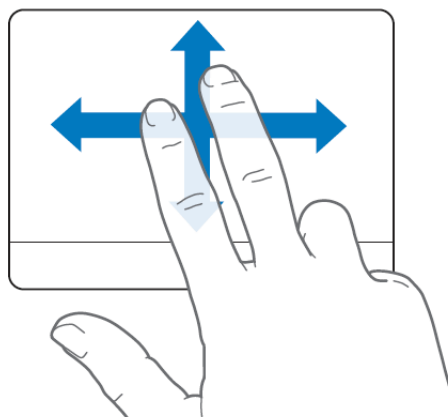

The following trackpad gestures work in certain applications, such as Preview or iPhoto. For more information, choose Help > Mac Help and search for “trackpad.”

Two-finger pinching lets you zoom in or out on PDFs, images, photos, and more.

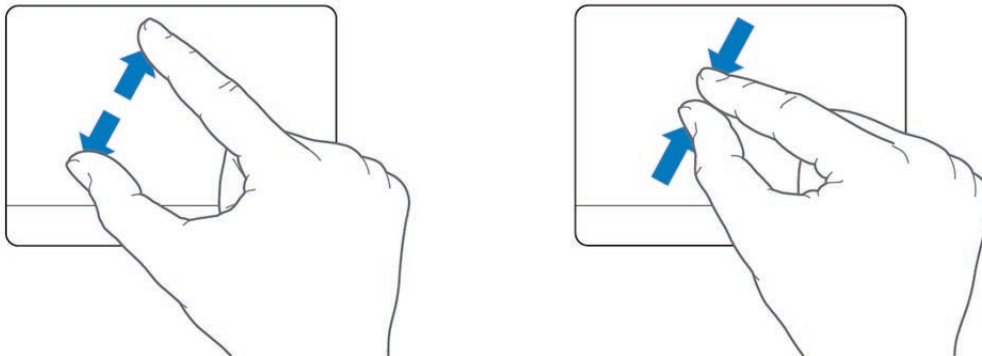

Keyboard features

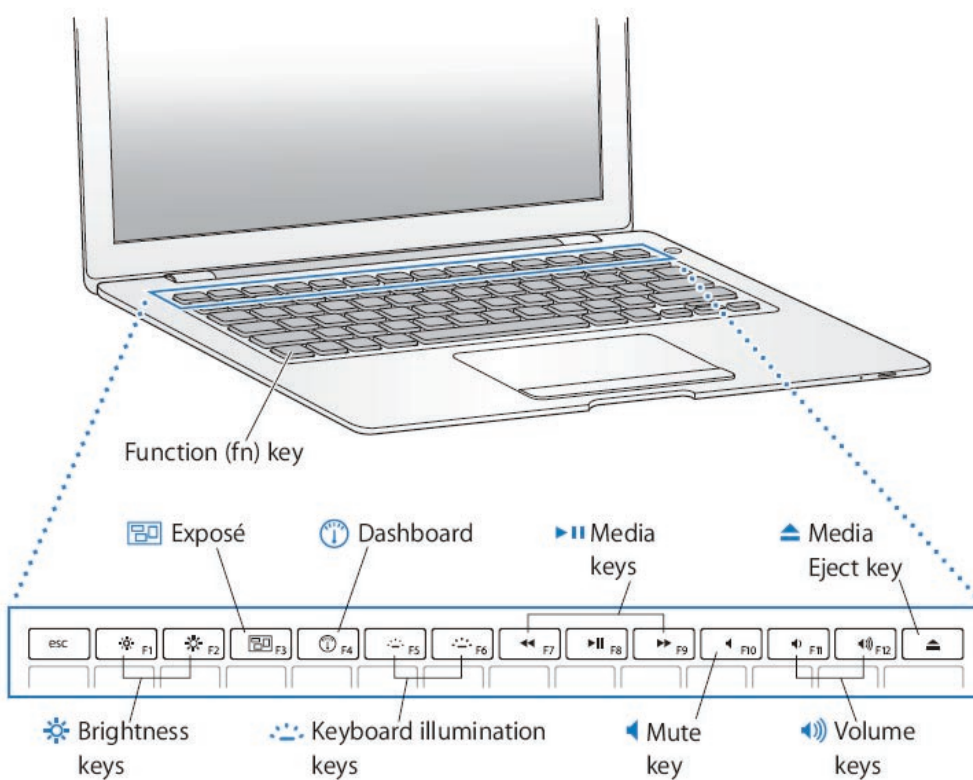

New Parts and Procedures

Accessing the components

Remove the bottom case to access the components.



Note: Before resting the unit on the workbench, make sure the work area is clear of all debris and contaminants to avoid damaging the display housing.

Serial number

The system serial number is etched into the bottom case (shown below). It is centered just below the regulatory markings. See the bottom case section for information on serial number transfer.

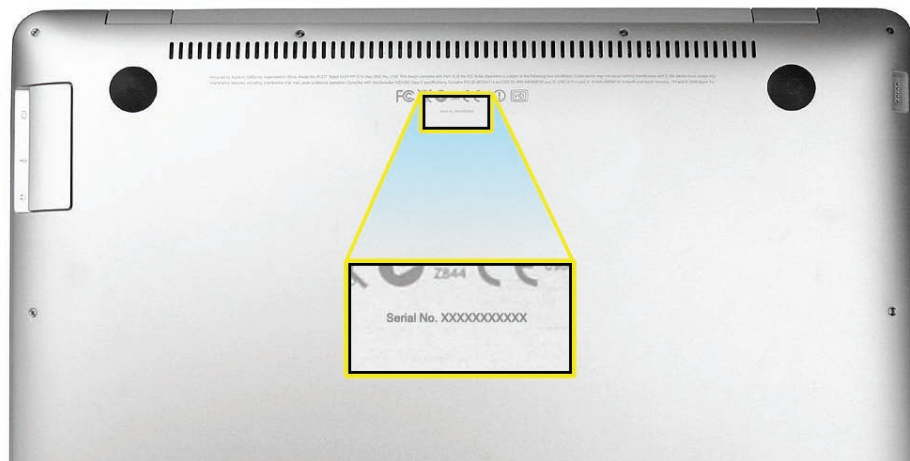

Bottom case angles and curves

Warning: The bottom case screws are inserted at an angle. When reinstalling these screws make sure you have inserted them at that appropriate angle. Before turning the screw into the boss, make sure the threads are properly aligned. Use the screwdriver to seat the screw at the correct angle, and then turn the screw backward (counterclockwise) until you feel the threads “click” into place. Otherwise, you can damage the screw boss which is part of the top case.

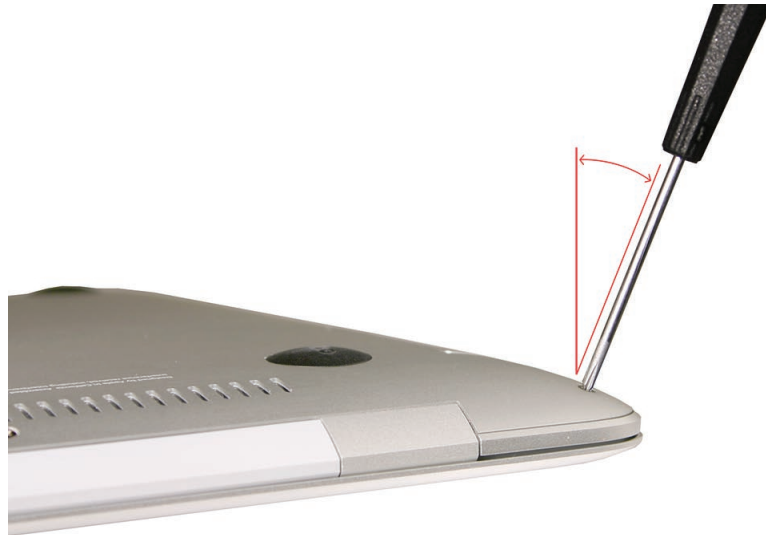

The front edge of the bottom case has five fragile metal clips that fit into five overhanging tabs on the top case. Be sure to remove and reinstall the bottom case at a 30° angle.

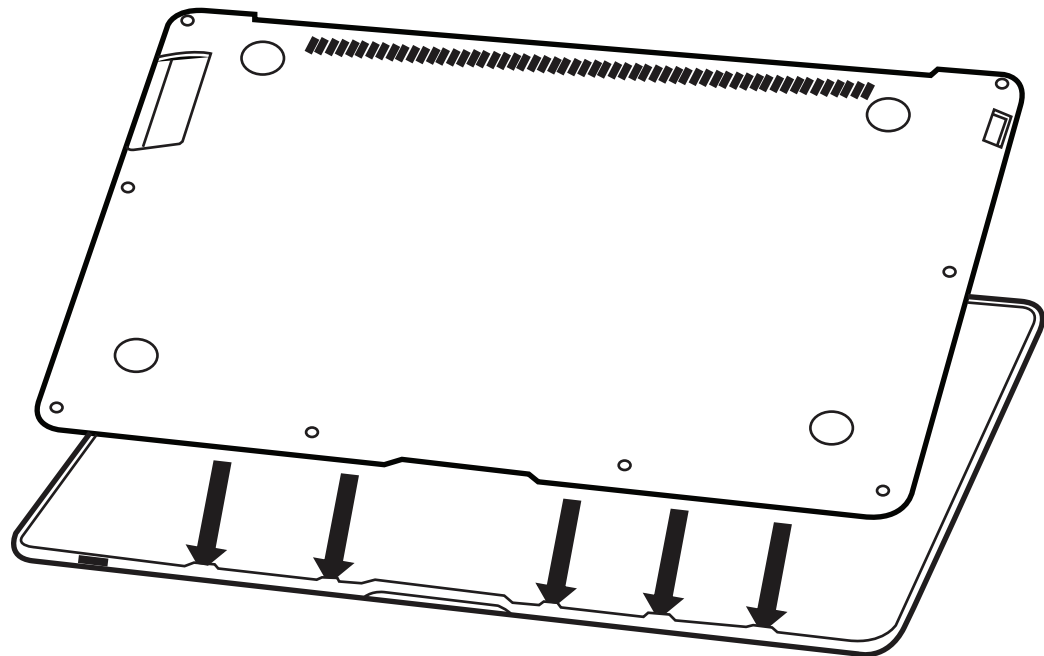

A map of the major modules in the MacBook Air

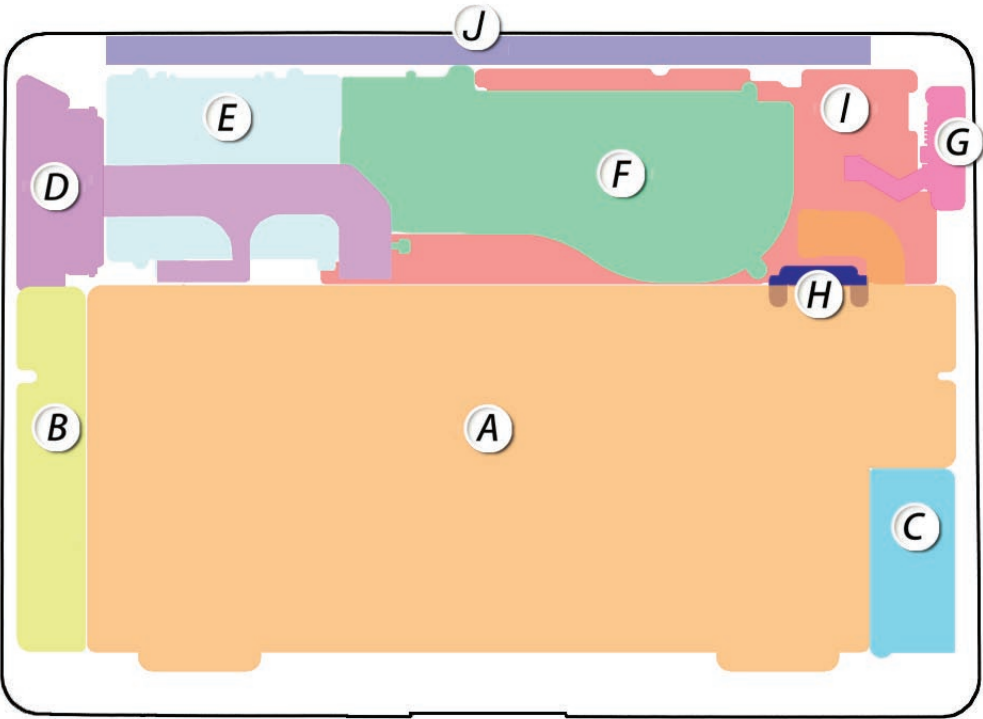
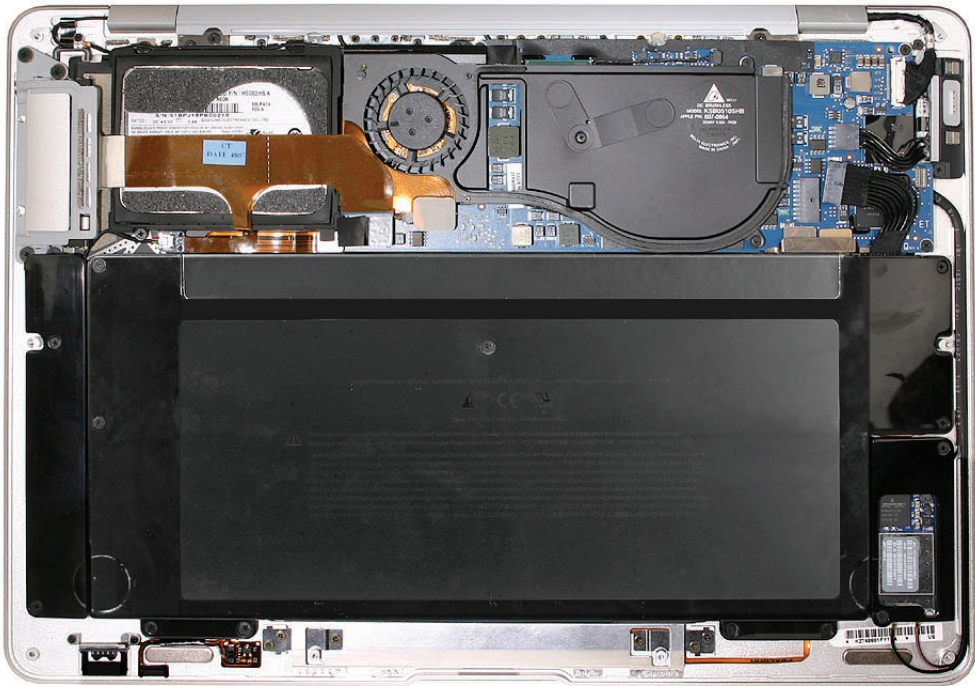

- A – Battery
- B – Speaker
- C – Combo card
- D – Port hatch
- E – Hard drive
- F – Thermal module
- G – MagSafe port
- H – Flex bracket
- I – Logic board
- J – Display (hinge)

The new MacBook Air contains an internal-only battery that is not accessible from the exterior and is serviceable by authorized Apple service providers only.

Warning: Unlike previous systems, when you remove the bottom case, power is still available to the logic board. Before any further work, disconnect the battery from the logic board connector.



WARNING: Because the battery is internal and connected to the logic board via cable, it **MUST BE DISCONNECTED** before performing service procedures. If you fail to do so, live current from the battery will short circuit the components and render the logic board and/or LVDS cable unusable.

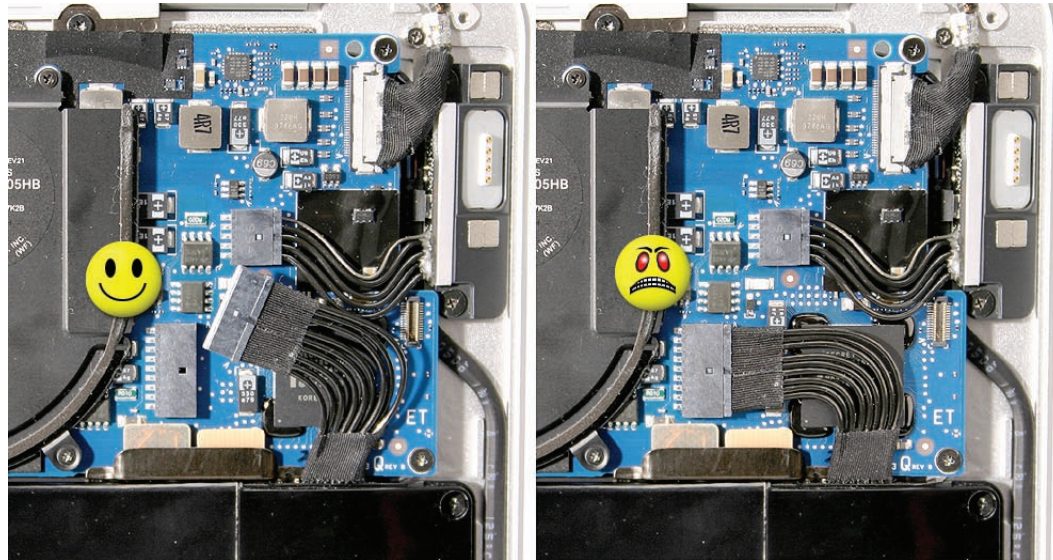

Cables and Connectors

Many cables and cable connectors are very delicate and require specific removal procedures. Also, new, environmentally friendly Halogen-free materials tend to be stiffer and less pliable, and thus require careful handling to avoid damage.

Sleep Sensor

The sleep sensor is located to the left of the sleep indicator light. Like the MacBook Pros, the magnet is in the display assembly, but since this system is so thin, it is possible to trigger the sleep sensor with external magnets. For example, when you stack a MacBook Air one on another, the sleep magnet in the bottom system's display assembly will trigger the sleep sensor on top.

Battery Icon

A new battery icon, with a triangle and exclamation point inside it means the battery is not performing to specifications (low capacity). It informs the user to have the battery replaced.

Display Repair

Display replacement is with a whole clamshell service part only.

General Module Notes

Module name	Notes
Combo AirPort/Bluetooth card	Both functions are on a single card.
Hard drive, 80GB, PATA	This part comes with shock mounts pre-applied, including foam pad and rubber ring (snubber) and flex cable. Do not remove any of these parts.
Hard drive, 64GB, SSD, PATA (SSD = Solid State Drive)	Although a solid state drive, the same shock mounts are applied like the conventional hard drive.
Battery, lithium ion	Not a user-installable part. Handle with care as the enclosure is not designed to withstand being dropped or exposed to air.
Power adapter, 45W	The connector is compatible with other Intel-based MacBook and MacBook Pro units. However, with a 45W rating, it has limited capability to charge or even start up previous MacBook and MacBook pro models.
Logic board	There are two main logic board configurations: 1.6GHz and 1.8GHz. Both have 2 GB of soldered-on RAM and use Intel Graphics X3100. The display LED's DC-to-DC converter is on this board.
Display clamshell	The clamshell contains the display, built-in camera, ambient light sensor and microphone. The LVDS cable carries data signals for the display video, camera, and ambient light sensor.
MacBook Air SuperDrive, external	The external MacBook Air SuperDrive only works with the MacBook Air. Other systems can see the drive itself but cannot load the media.
Top case w/ keyboard	The top case houses the keyboard, backlit panel, LED, and (IPD) Input Devices board. The IPD board provides control logic for the trackpad on the top, which is calibrated to the top case. The values are stored on the IPD board. Thus, the two are a matched set. Do not disconnect any flex cables from the IPD board other than the main IPD cable to the logic board. All other flex cables connect to parts that are not replaceable.
Thermal module	Metal heatsink with attached fan.
Speaker assembly	Speaker assembly contains a mono speaker plus an audio board integrated into a plastic housing.
MagSafe port assembly	This MagSafe connector is compatible with all the other MagSafe adapters. However, the overmolding on those adapters causes the system to sit unevenly, resulting in stress to the DC connector cable.
Port hatch assembly	The port hatch assembly includes the hatch, ports, and flex cable. The flex cable connects to the audio board to provide analog audio out.
Audio board	The board is located in the integrated speaker assembly.

Support Tools

MacBook Air has an optional external USB SuperDrive that can be purchased separately. This option allows you to use the Mac OS X Install Disc 1 tools such as Disk Utility and password reset. You can also reinstall system software.

However, MacBook Air Mac OS X Install Disc 1 also comes with software drivers to share an optical disk drive on another machine. This remote machine can be a Macintosh running Mac OS X v10.4.10 or later, or a PC running Windows XP or Windows Vista.

With Remote Disc installed, you can share content of DVDs or CDs, or restore system software

and applications over AirPort or through an Ethernet connection (facilitated by a separate USB Ethernet adapter). In both cases, the two computers must be on the same subnet.

Migrate data (Mac only)	
via AirPort	Remote Mac OS X software
via USB Ethernet	Remote Mac OS X software
via USB Hard Drive	Time Machine software

Install application software, use disk-based tools (Disk Utility, Reset Password)	
via MacBook Air SuperDrive	Use Mac OS X Disc 1 or application Disc
via AirPort through remote Mac/Windows system	Use Mac OS X Disc 1 or application Disc with Mac OS X Remote Disk software
via Ethernet (with USB adapter) through remote Mac/Windows system	Use Mac OS X Disc 1 or application Disc with Mac OS X Remote Disk software

Re-install system software	
via MacBook Air SuperDrive	Use Mac OS X Disk 1
via AirPort through remote Mac/Windows system	Use Mac OS X Disc 1 with Mac OS X Remote Install software
via Ethernet (with USB adapter) through remote Mac/Windows system	Use Mac OS X Disc 1 with Mac OS X Remote Install software

Tools

Servicing the MacBook Air requires the following tools:

- Clean, non-marring work surface
- ESD wrist strap and mat
- Multi-compartment screw tray (such as a plastic ice cube tray)
- #000 Phillips screwdriver (magnetized)
- #00 Phillips screwdriver (magnetized)
- Torx T6 screwdriver (magnetized)
- Black stick (nylon probe 922-5065) or other non-conductive nylon or plastic flat-blade tool
- Display Repair Fixture (922-8538)
- Cosmetic cover kit (076-1284)
- Gasket kit (076-1285)
- Suction cup (922-8252)
- Thermal paste (922-7144)
- Alcohol pads
- Kapton tape (922-1731)
- Fine-point felt-tip permanent marker
- Standard #2 graphite pencil

-
- Ruler or straight edge
 - Needle-point metal probe
 - Needlenose pliers
 - Tweezers
 - Apple Pro keyboard and mouse (for troubleshooting)

Electrostatic Discharge (ESD)

Use a properly grounded ESD wrist strap and mat when working on the inside of the computer.

Service Manual Component Photos

In this manual, graphics or photos are intended to help illustrate procedures or information only. Some photos may show different levels of disassembly, board colors, configurations, or computer configurations than the computer you are working on.

Kapton® Tape Note

New Halogen-free Kapton tape is used to secure cables and connectors where necessary.

During disassembly, note any Kapton tape use and locations—reapply in the same manner. Do not over apply or build up tape on top of old tape; space tolerances are tight and build up or extraneous use of tape may cause pressure on other components.

Cable Routing Note

With the MacBook Air's thin enclosure height, the placement of parts and wiring is more critical than ever before. During disassembly, note the cable routing. Reassemble in the same manner. Verify that cables do not route over components when they should route into lower positions or channels. Verify that the cables are not strained or applying pressure to other components.

Screw Measurement Note

All screw measurements given are the specified full length. Actual measured lengths may vary.



Take Apart
MacBook Air



Bottom Case

Tools

This procedure requires the following tools:

- #00 and #000 Phillips screwdrivers (magnetized)
- Black stick (nylon probe 922-5065) or other non-conductive nylon or plastic flat-blade tool
- Multi-compartment screw tray (such as a plastic ice cube tray)

Preliminary Steps

This procedure requires placing the unit upside down on its display housing. Always use a clean, debris-free static mat to avoid scratches and other cosmetic damage to the unit.

Part Overview



Removal Procedure

Critical: Each screw boss leading from the top case to the bottom case is angled at a different pitch; thus, the angle at which you drive or loosen the screws **must** correspond accordingly.



1. Remove ten Phillips #000 screws, starting from the top center and moving outward in a circular fashion in both directions.

Note: See the screw map in the Views chapter for the exact placement and size of each screw.

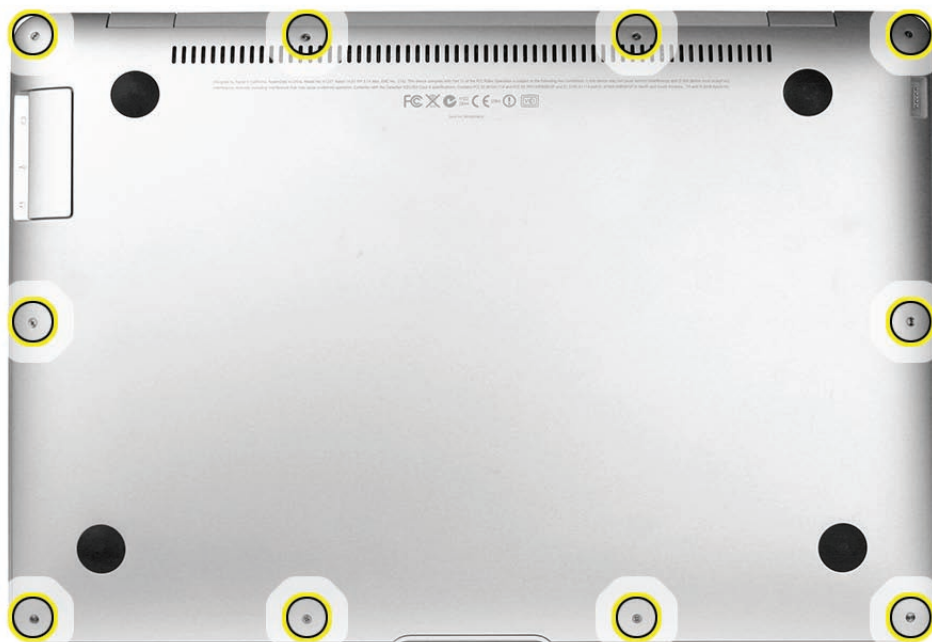

-
2. Use your fingernails to grip the edge of the bottom case in the rear corners near the display hinge, or use a black stick as a wedge to gently pry up the bottom case a few millimeters—enough to grab the edges with your fingers. You may need to pull with slightly more force on the right side to lift the corner near the MagSafe adapter port.



3. Pivot the rear edge upward a few inches to a 30° angle. At that same angle, pull the bottom case outward from the front edge of the top case to preserve the integrity of the front clips.



Serial Number Transfer Instructions

IMPORTANT: When replacing the bottom case of a MacBook Air, retain the customer's original bottom case until the repair is complete.

CRITICAL: Before installing the replacement bottom case, transfer the serial number from the original bottom case to the replacement.

1. Locate the serial number on the top center of the bottom case (near the vent holes), etched below the FCC verbiage as below. You may need a magnifying glass to read the characters.

Note: In a bootable system, you can also find the serial number in "About this Mac" or Apple System Profiler. If the bottom case of the customer's unit has been previously replaced, see the subsequent steps for the intended final written location.

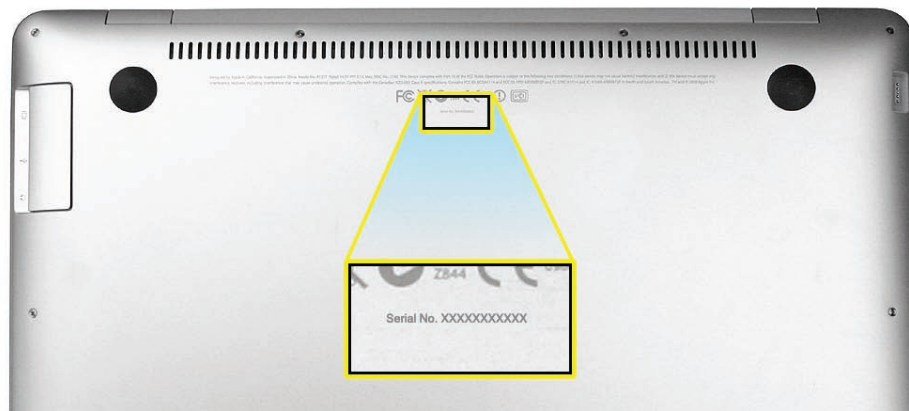

CAUTION: Take great care in deciphering the small typeface of the etched serial number on the bottom case. It is imperative that you transfer the correct alphanumeric characters. Keep in mind that Apple serial numbers always use the numbers 1 and 0 instead of the Roman letters "I" and "O."

2. On the *inside* surface of the replacement bottom case, use a fine tip permanent marker to write the original serial number clearly and legibly in uppercase box letters in the location below. Look in this location for the serial number on a previously replaced bottom case.

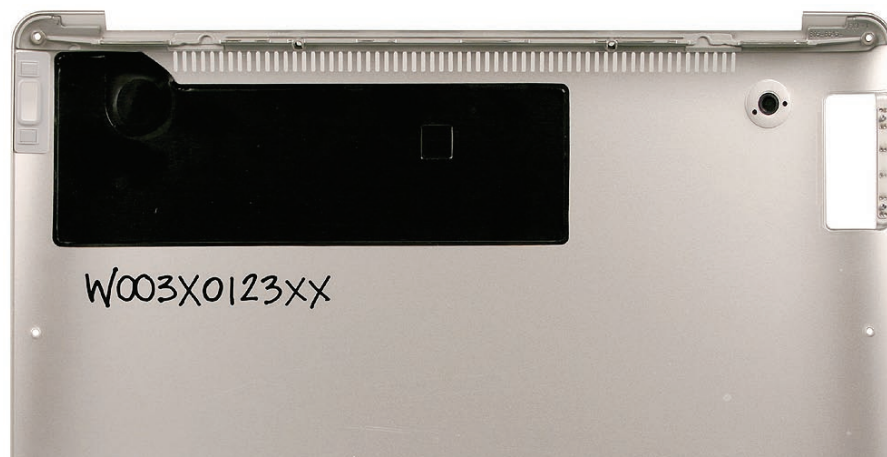

Reassembly Procedure

Caution: Each screw boss leading from the top case to the bottom case is angled at a different pitch; thus, the angle at which you drive or loosen the screws **must** correspond accordingly.



Before actually turning the screw into the boss, make sure the threads are properly aligned. Use the screwdriver to seat the screw at the correct angle, and then turn the screw backward (counterclockwise) until you feel the threads 'click' into place. You may need to do this a few times to get the exact thread placement. If you feel resistance, back the screw out and start again. Failure to do so can strip the boss and render the entire top case unusable.

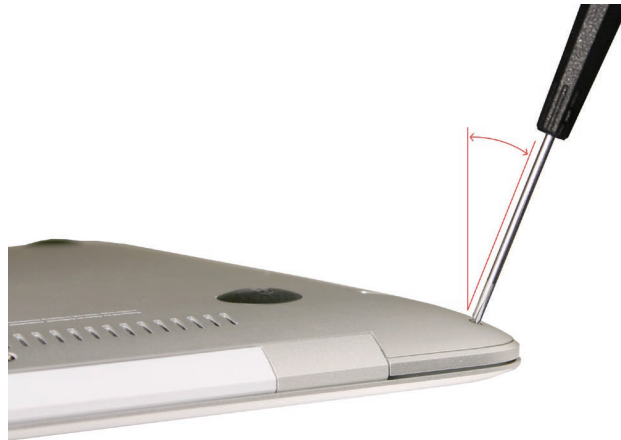

1. While holding the bottom case at a 30° angle, insert the clips on its front edge into the tabs on the top case before lowering into place. Make sure no cables are pinched (e.g., the Airport/Bluetooth antenna assembly on the right side and the microphone cable in the rear).

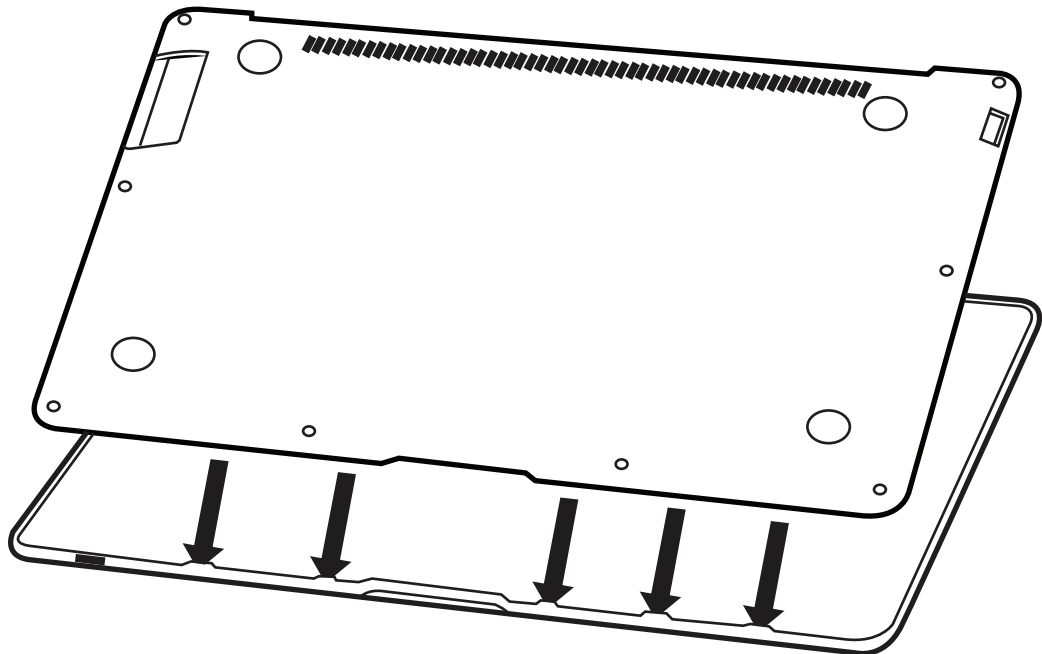

2. Insert ten #000 Phillips screws in the following order, paying close attention to the angle. If a particular screw does not seem to mate easily with its screw boss, set that screw aside and try another of the same size. It should take little effort to screw it in. See note below.

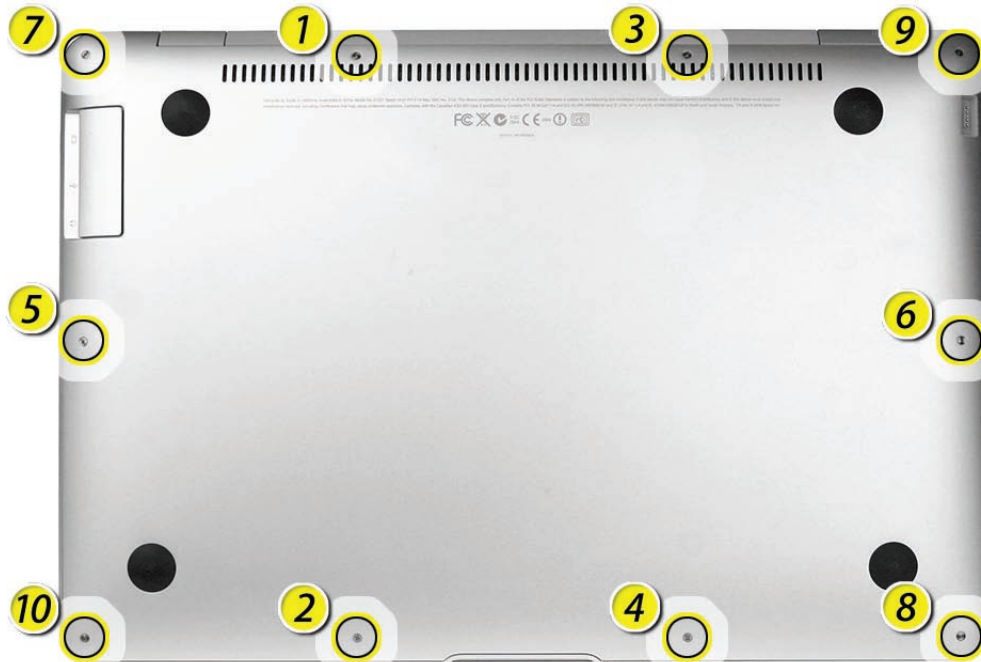
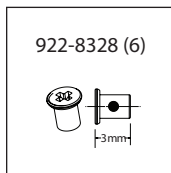
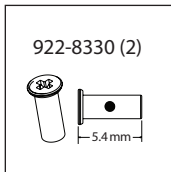
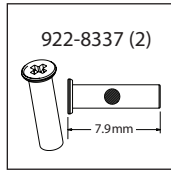

Caution: Each screw boss leading from the top case to the bottom case is angled at a different pitch; thus, the angle at which you drive or loosen the screws **must** correspond accordingly.



Before actually turning the screw into the boss, make sure the threads are properly aligned. Use the screwdriver to seat the screw at the correct angle, and then turn the screw backward (counterclockwise) until you feel the threads 'click' into place. You may need to do this a few times to get the exact thread placement. If you feel resistance, back the screw out and start again. Failure to do so can strip the boss and render the entire top case unusable.



Quick Test

Before restarting the system to verify the repair, check for structural and cosmetic integrity by performing the following tests:

- Hold the unit firmly in both hands and gently rock it back and forth; then carefully turn the unit over, listening for any loose components or connectors.
- Place the unit on a clean, flat surface and check for wobble.





Battery

Tools

This procedure requires the following tools:

- #00 and #000 Phillips screwdrivers (magnetized)
- Black stick (nylon probe 922-5065) or other non-conductive nylon or plastic flat-blade tool
- Multi-compartment screw tray (such as a plastic ice cube tray)

Preliminary Steps

This procedure requires placing the unit upside down on its display housing. Always use a clean, debris-free static mat to avoid scratches and other cosmetic damage to the unit.

Before you begin, remove the bottom case.



CAUTION: The battery **must** be disconnected from the logic board before proceeding further. Failure to do so is likely to result in irreparable damage to expensive components such as the logic board and/or LVDS cable.

Part Location

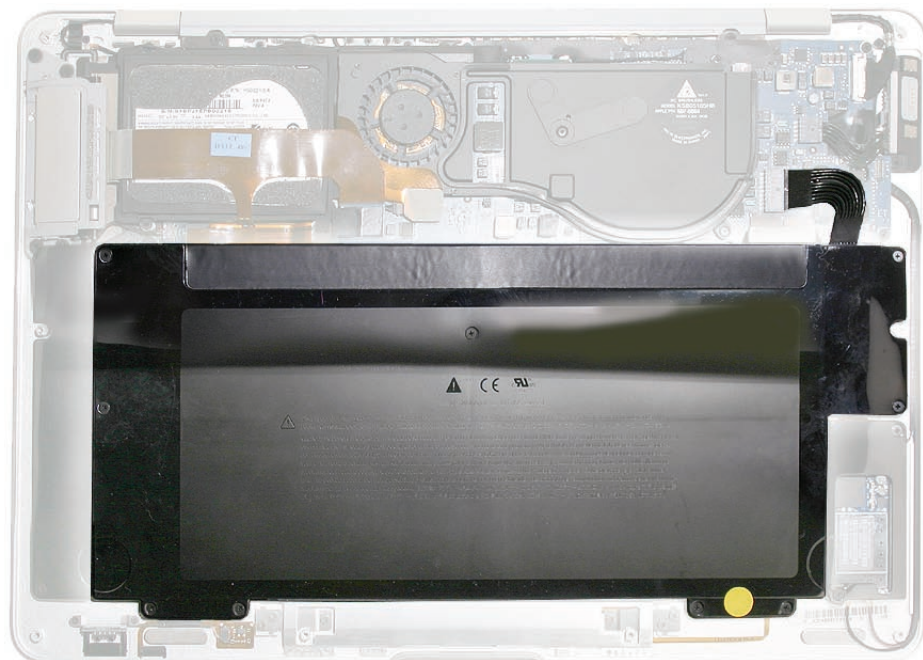

Removal Procedure

1. Disconnect the battery cable connector from the logic board, taking care to keep the cable connector flat when pulling it out of its mate. Use your thumb on top and a black stick beneath to prevent too much bend in the cable. An alternative is to use your index fingers (and nails) to grab the sides of the connector and pull straight out, level with the board.

Note: Halogen free cables and connectors are delicate. Handle with care to avoid damage.

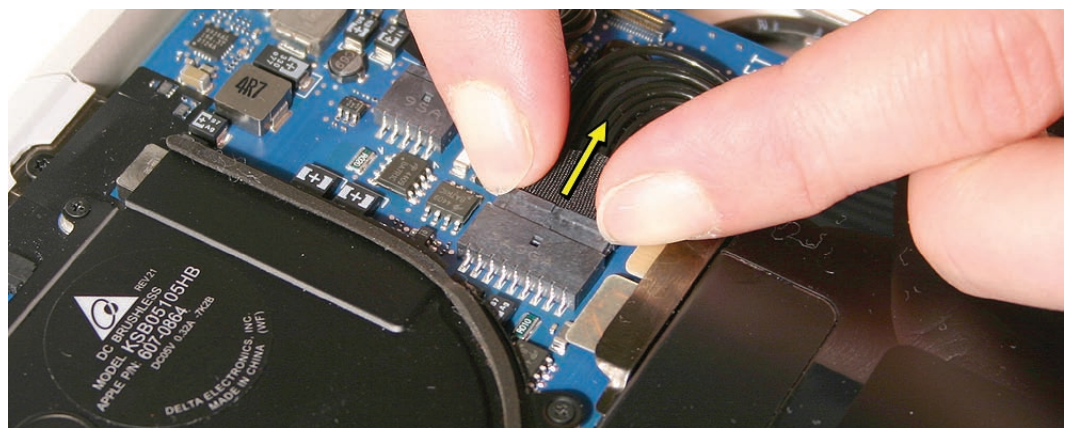
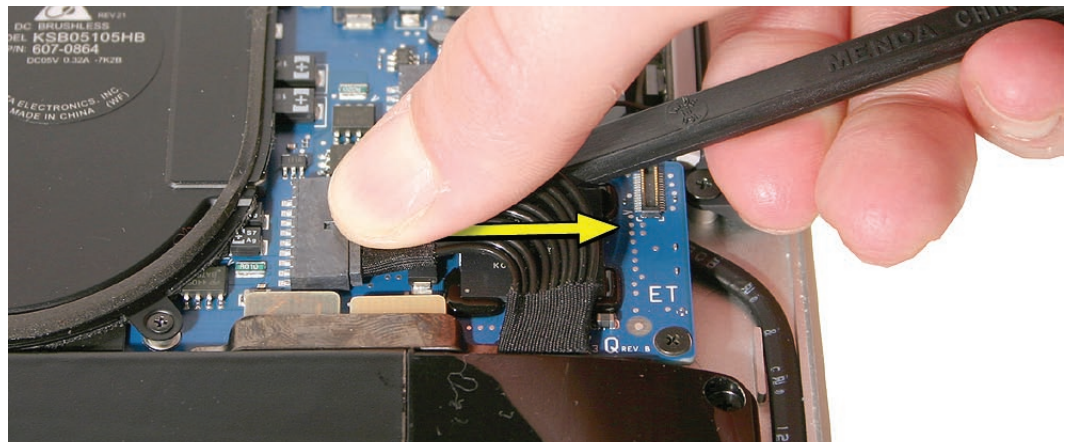
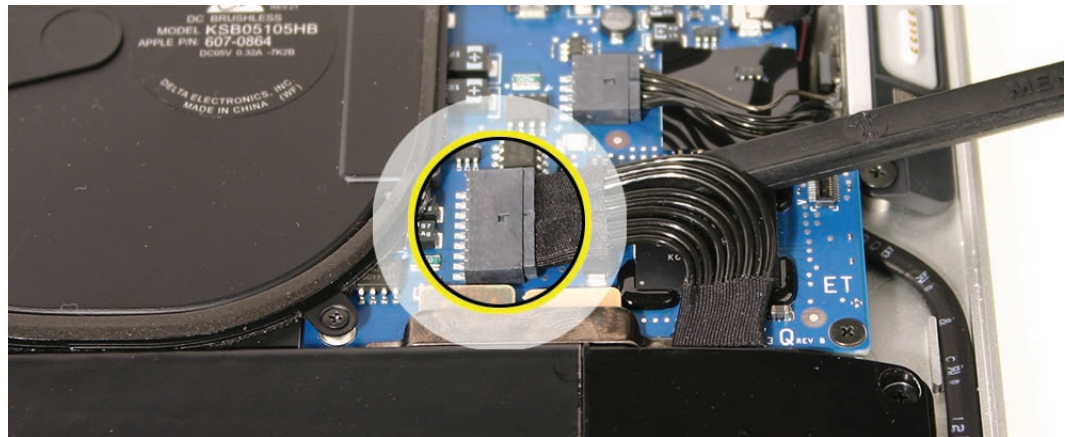

2. Remove nine #00/000 Phillips screws in the following order.

Note: You may find screws tightly wedged in their sockets. If so, avoid stripping the head by bearing down firmly (albeit carefully) to release the screw and its locktight adhesive.

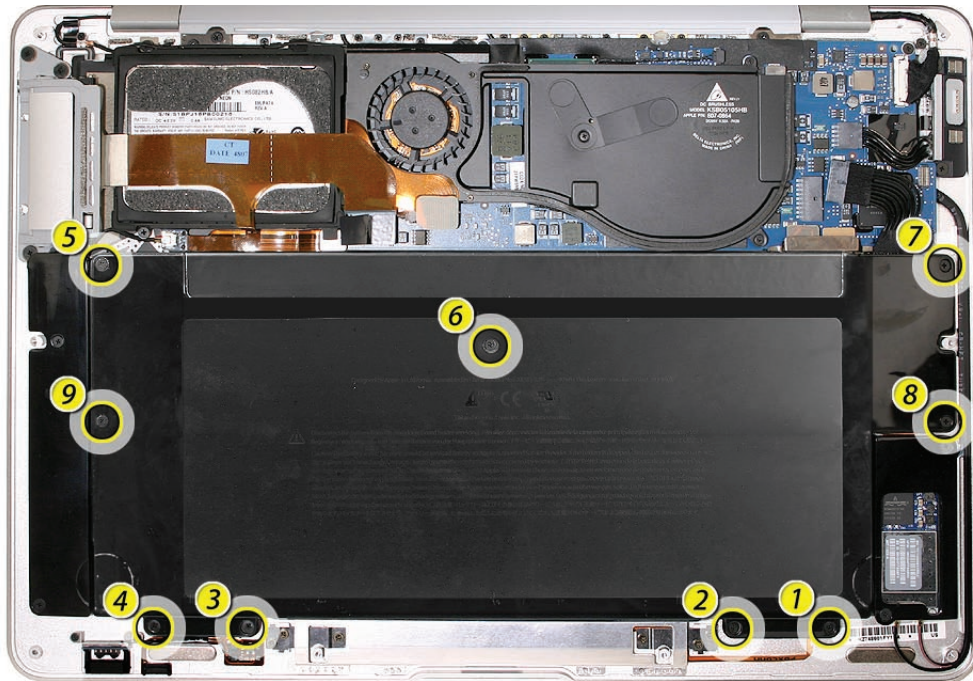

3. Lift the battery out evenly with both hands on either side to avoid bending or straining the battery pack. Always handle by the edges to avoid pressure to its inner surfaces. To keep the battery cable intact, do not lift or hold the battery using the cable or connector.



Reassembly Procedure

1. Align the screw hole in the upper left with its corresponding boss on the top case, and set the battery gently in place.
2. Install the nine #00/000 Phillips screws in the following order.

Note: This screw order is different from the removal order in the previous section.

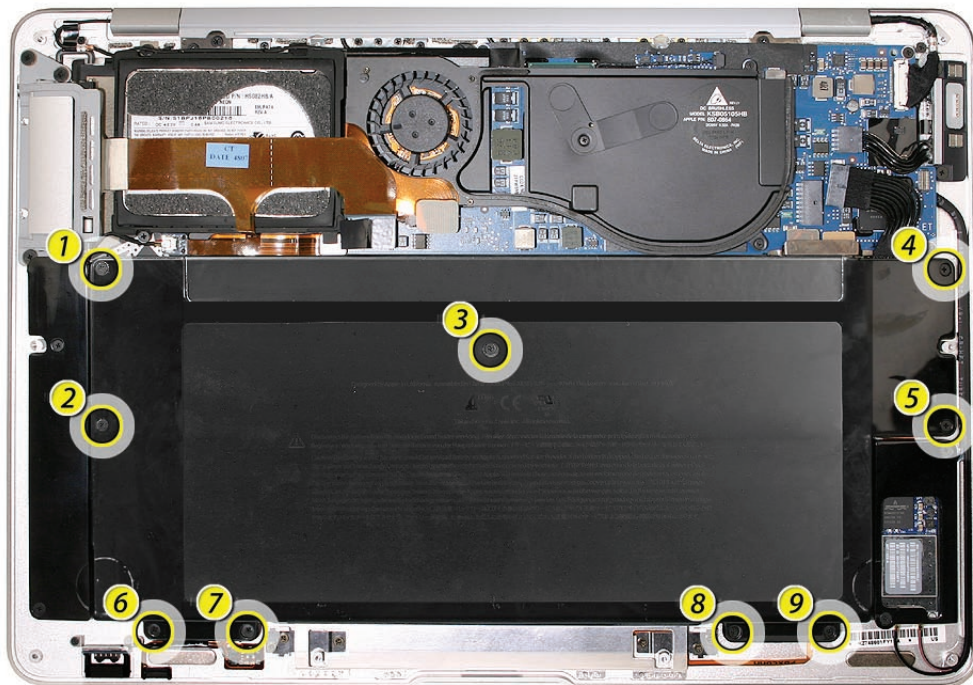

CAUTION: Delicate screw pressure and precise torque must be applied to avoid cracking the battery case. Turn the screws until just hand-tight, then back out 1/4 turn.

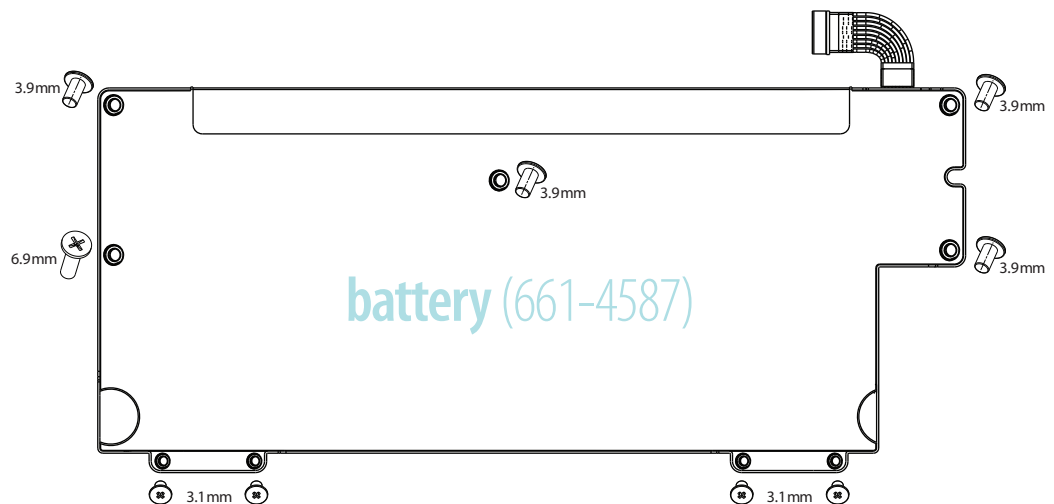

Quick Test

Verify your repair by successfully starting up the system on battery power only.



AirPort/Bluetooth Card

Tools

This procedure requires the following tools:

- #00 and #000 Phillips screwdrivers (magnetized)
- Black stick (nylon probe 922-5065) or other non-conductive nylon or plastic flat-blade tool
- Multi-compartment screw tray (such as a plastic ice cube tray)

Preliminary Steps

This procedure requires placing the unit upside down on its display housing. Always use a clean, debris-free static mat to avoid scratches and other cosmetic damage to the unit.

Before you begin, remove the following:

- Bottom case
- Battery



CAUTION: The battery **must** be disconnected from the logic board before proceeding further. Failure to do so is likely to result in irreparable damage to expensive components such as the logic board and/or LVDS cable.

Part Location

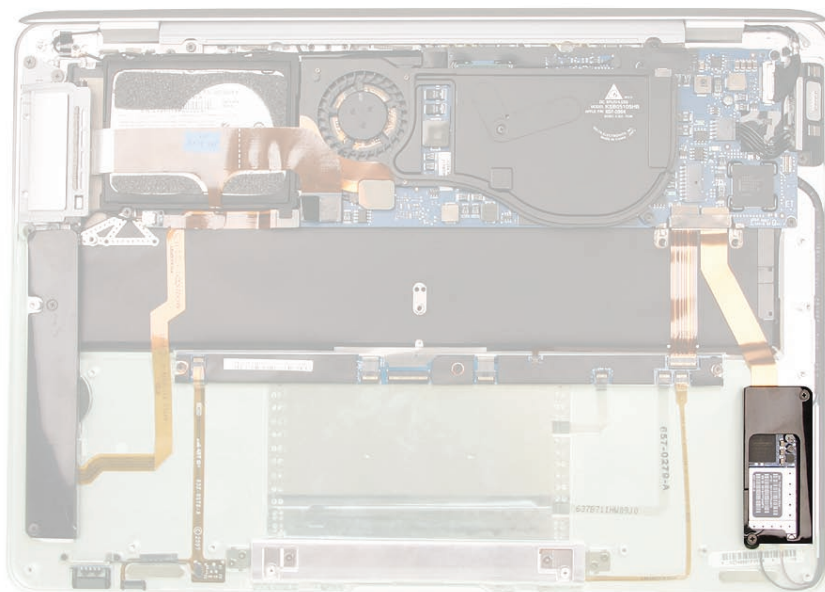

Removal Procedure

1. Remove the two #000 Phillips screws at the upper right (3.9 mm) and lower left corner (4.7 mm) of the black plastic Airport/Bluetooth card cover.

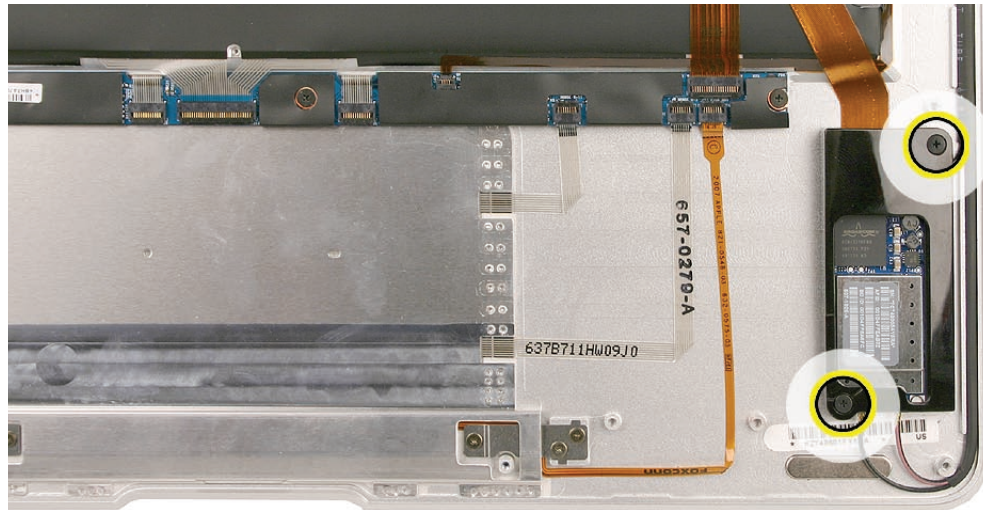

2. Disconnect the flex cable from the logic board.
3. Disconnect two Airport antenna connectors on the lower part of the card and Bluetooth antenna connector on the top right.
4. Remove the small black 3.2 mm screw in the upper right corner.

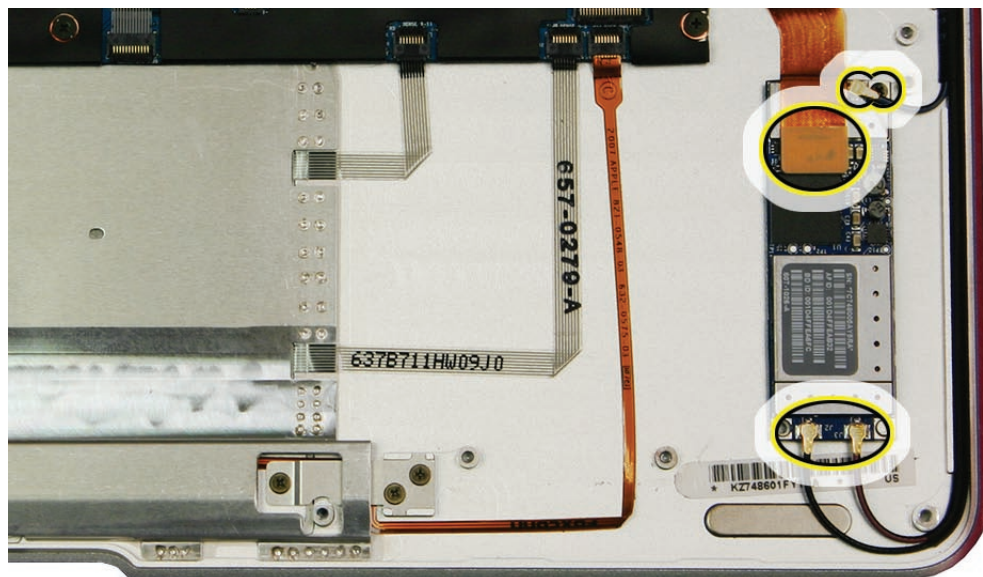

5. Remove the Airport/Bluetooth card carefully, holding the board by the edges only.
6. Store the Airport/Bluetooth card in an anti-static, shielded bag.

Reassembly Procedure

1. When reinstalling the Airport/Bluetooth card, use the pin (shown below) on the top case to align the bottom right corner of the board.

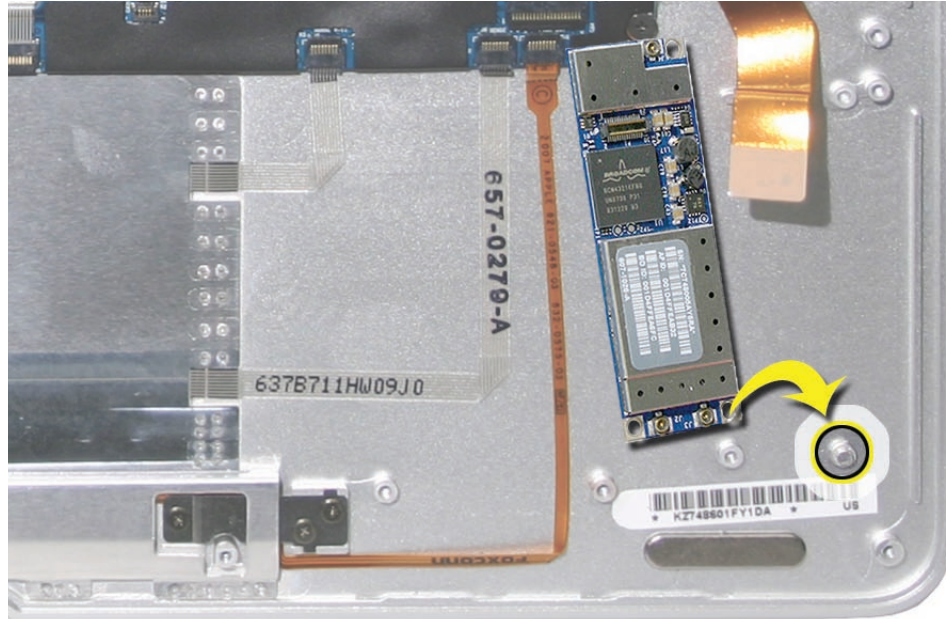

2. Install the small black Phillips 3.2mm screw in the upper right corner (see below).
 3. Connect the Bluetooth antenna connector at the top right (see below).
- Note:** Be sure to route the antenna connector and cable beside the screw for a secure fit.
4. Connect the two Airport antenna connectors below. Cable lengths correspond to placement. Connect the flex cable from the logic board.

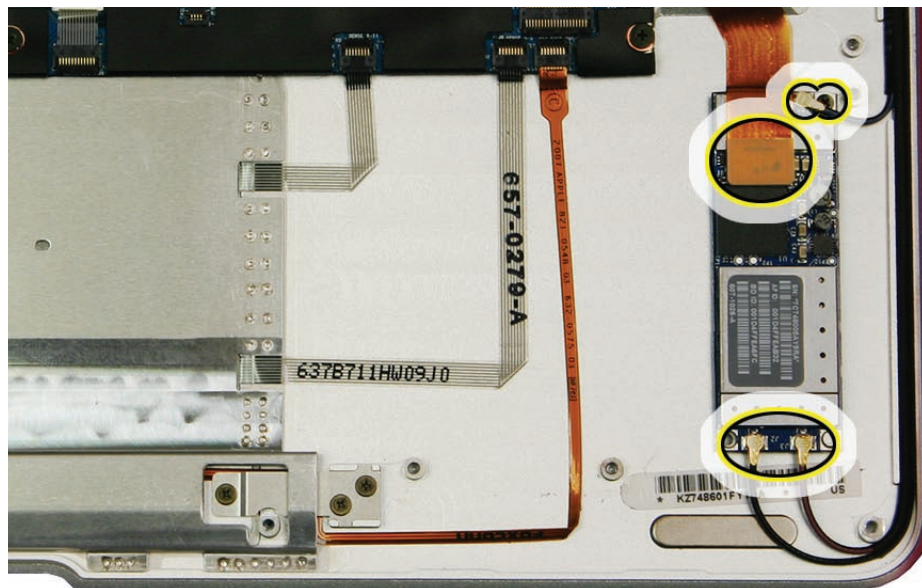

5. Install the two #000 Phillips screws at the upper right (3.9 mm) and lower left corner (4.7 mm) of the Airport/Bluetooth card cover.

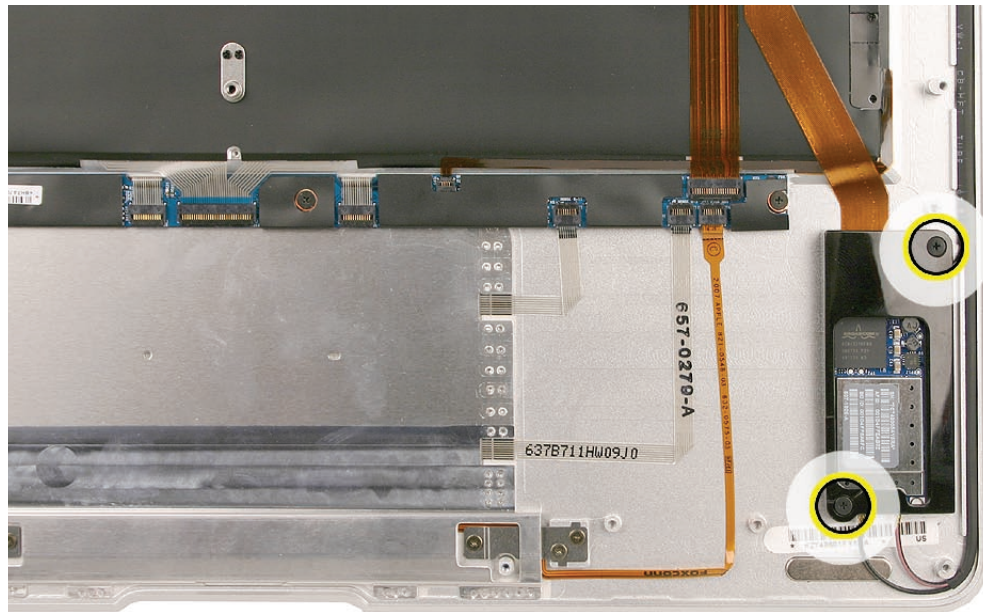

Quick Test

1. In Apple System Profiler, verify AirPort and Bluetooth presence as well as settings.
2. Check AirPort antenna functionality by browsing to a known-good web site.
3. Check Bluetooth antenna functionality by attempting to transfer a file to another Mac.



Speaker Assembly

Tools

This procedure requires the following tools:

- #00 and #000 Phillips screwdrivers (magnetized)
- Black stick (nylon probe 922-5065) or other non-conductive nylon or plastic flat-blade tool
- Multi-compartment screw tray (such as a plastic ice cube tray)

Preliminary Steps

This procedure requires placing the unit upside down on its display housing. Always use a clean, debris-free static mat to avoid scratches and other cosmetic damage to the unit.

Before you begin, remove the following:

- Bottom case
- Battery



CAUTION: The battery **must** be disconnected from the logic board before proceeding further. Failure to do so is likely to result in irreparable damage to expensive components such as the logic board and/or LVDS cable.

Part Location

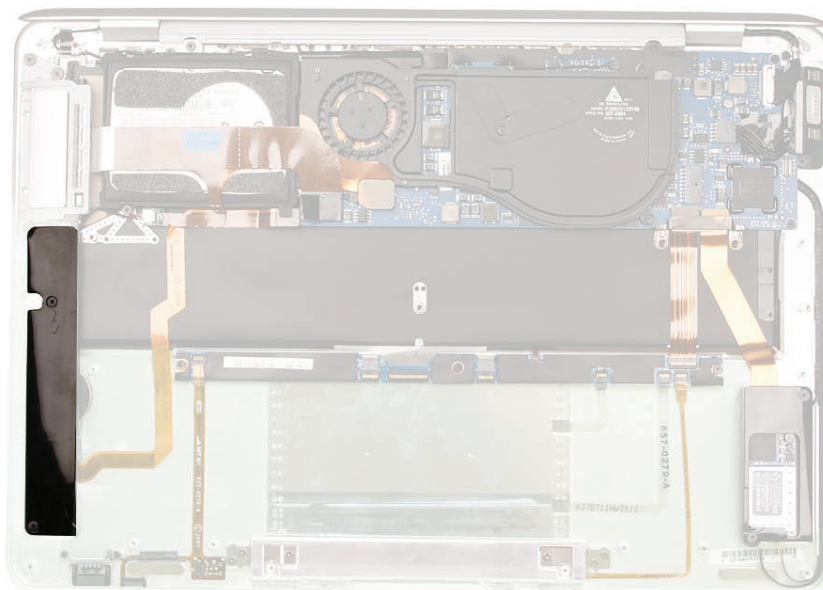

Removal Procedure

1. Remove the two Phillips #000 screws securing the speaker assembly cover to the top case.

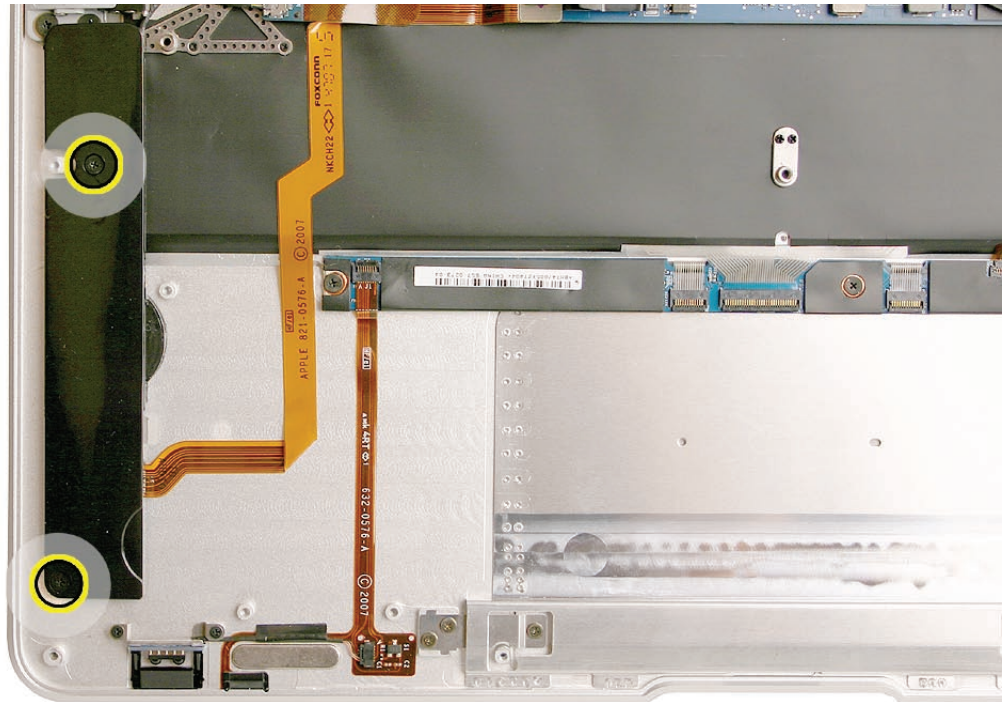

2. Carefully lift the speaker assembly and disconnect the audio cable connector (shown below).

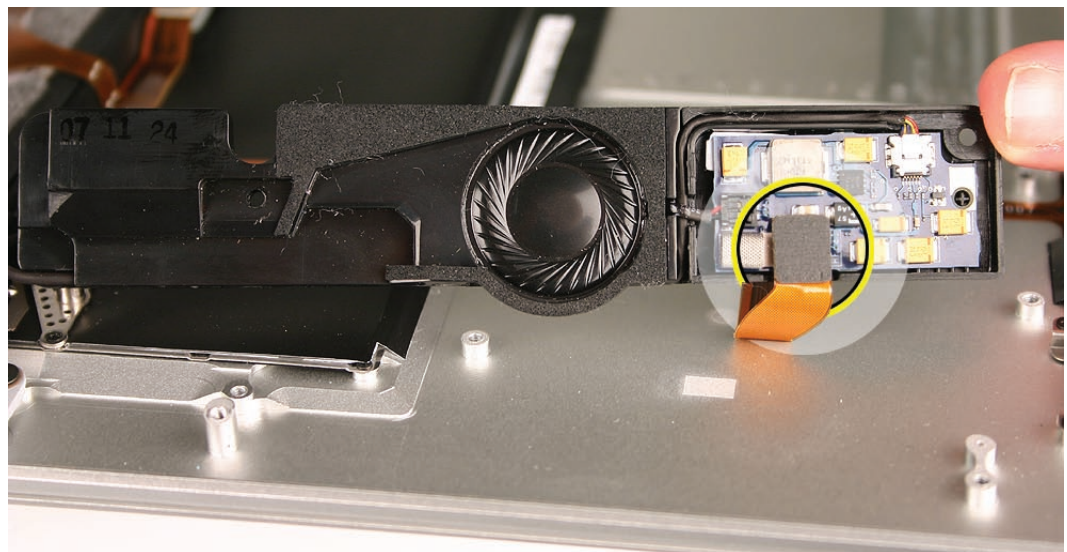

- Slide a black stick between the audio jack cable leading from the port hatch assembly and the speaker board flex cable connected to the top case, gently loosening the adhesive between the two cables little by little.

Note: While separating the upper cable from the lower one, hold the lower one down as you move the black stick to keep the speaker flex cable adhered to the top case.



- Carefully pry up the small cable connector board from its tab on the hard drive frame. Note the small plastic peg at the corner of the tab which mates with a corresponding hole on the connector board. Try to keep the adhesive bonded to the hard drive frame if possible.

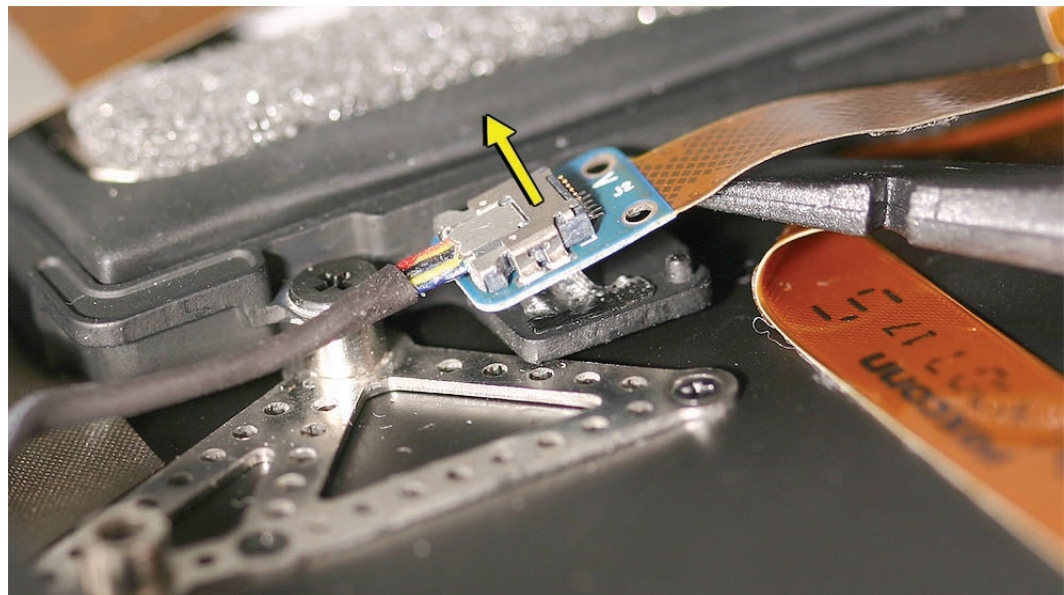

- Carefully disconnect the audio out cable connector (shown below).

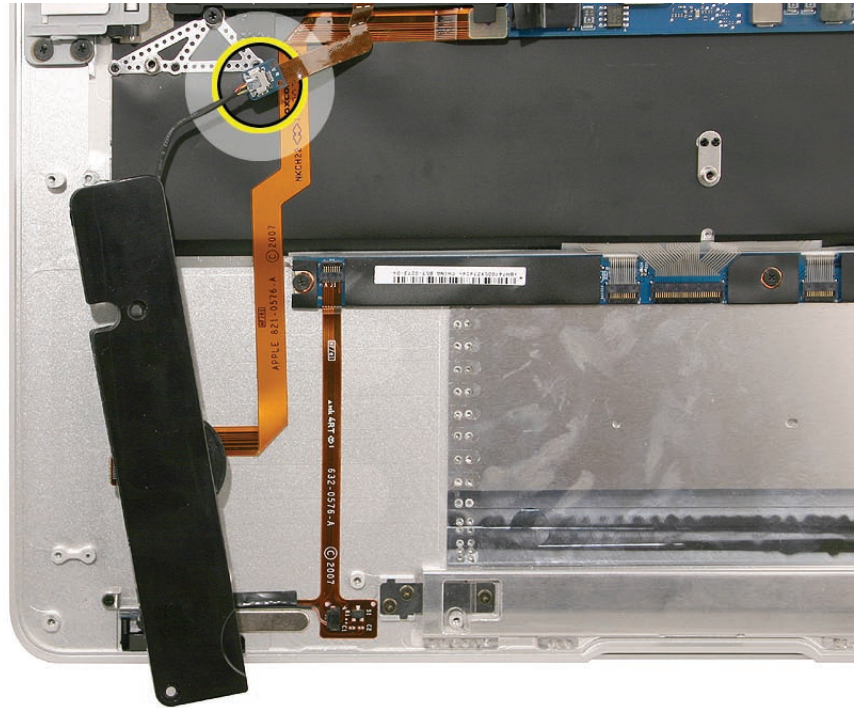

Note that the audio board is a fixed part of the speaker housing assembly and is not removable.

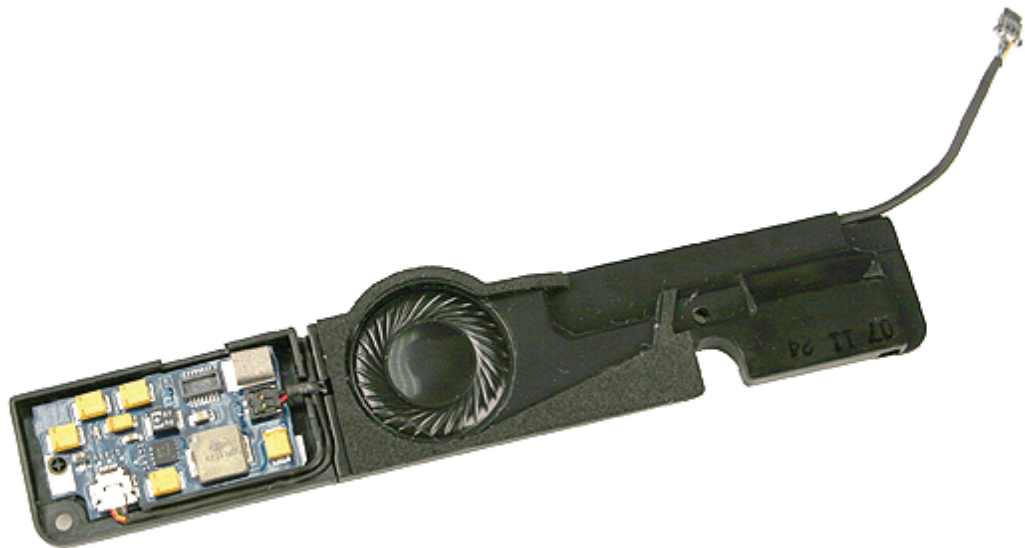

Reassembly Procedure

1. Connect the audio out cable connector.

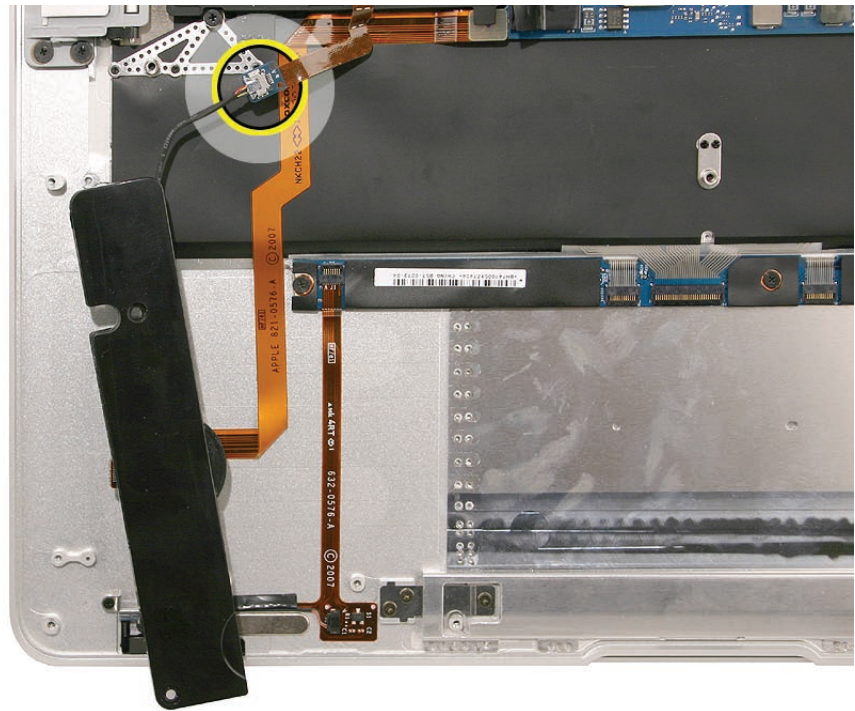

2. Gently place the cable connector board on the hard drive frame tab, using the peg at the front of the tab as a guide for placement. Make sure the board is firmly adhered to the tab and the black cable leading from the connector is routed close to the top case.

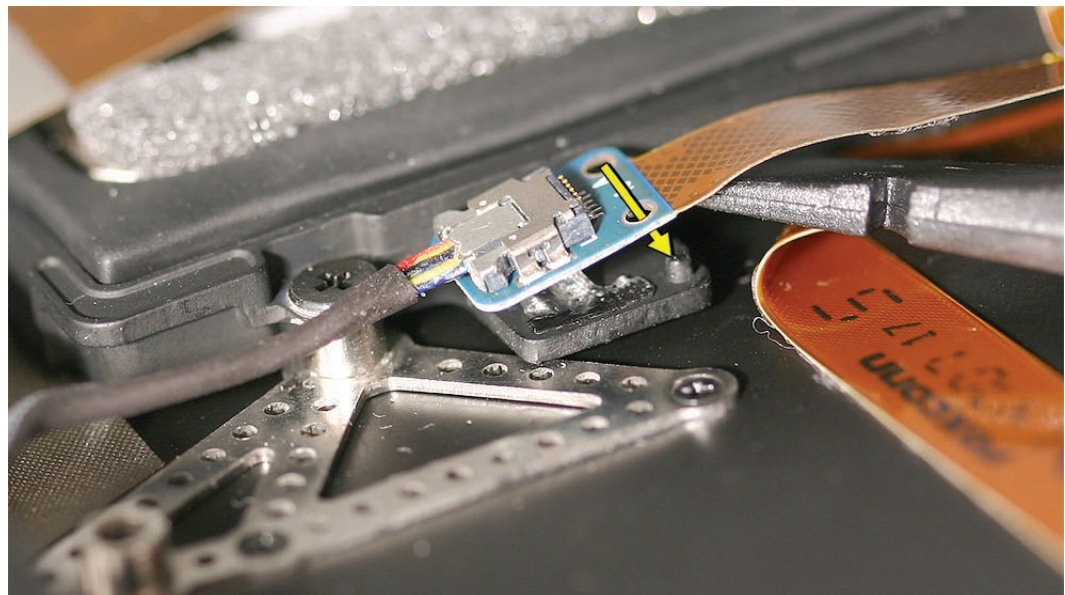

1. Connect the audio cable connector to the speaker board. Place the speaker assembly in the correct orientation on the top case.

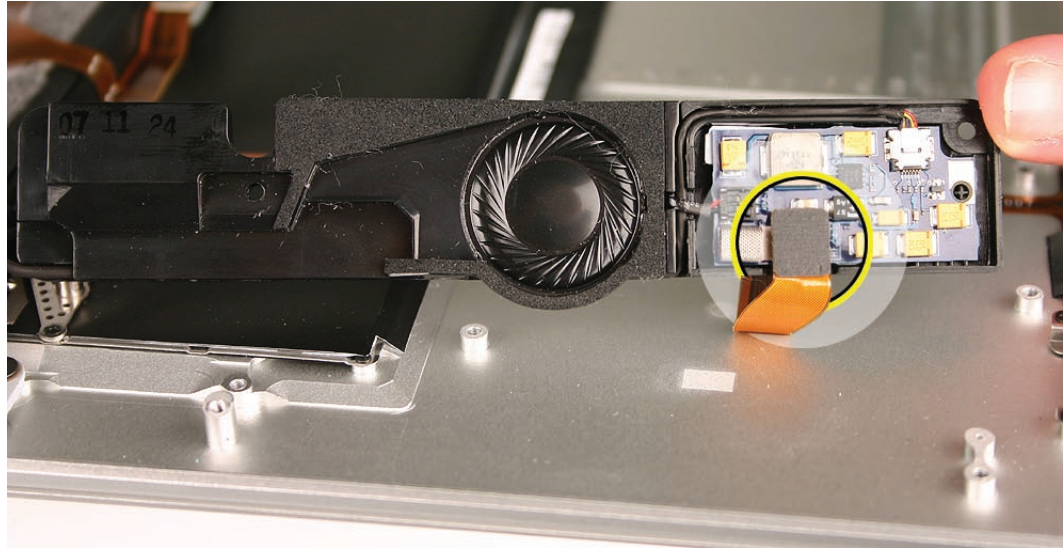

2. Install the two Phillips #000 screws on the speaker assembly cover.

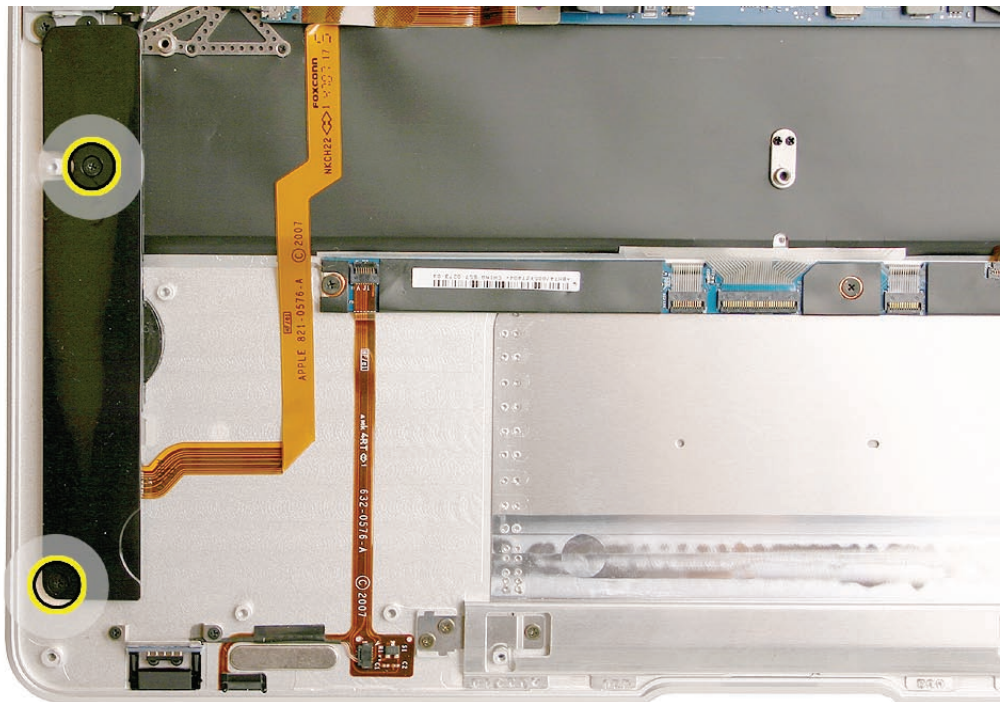

Quick Test

Play a QuickTime video to check speaker output as well as the audio-out jack on the port hatch.



Port Hatch Assembly

Tools

This procedure requires the following tools:

- #00 and #000 Phillips screwdrivers (magnetized)
- Black stick (nylon probe 922-5065) or other non-conductive nylon or plastic flat-blade tool
- Multi-compartment screw tray (such as a plastic ice cube tray)

Preliminary Steps

This procedure requires placing the unit upside down on its display housing. Always use a clean, debris-free static mat to avoid scratches and other cosmetic damage to the unit.

Before you begin, remove the following:

- Bottom case
- Battery
- Speaker assembly



CAUTION: The battery **must** be disconnected from the logic board before proceeding further. Failure to do so is likely to result in irreparable damage to expensive components such as the logic board and/or LVDS cable.

Part Location

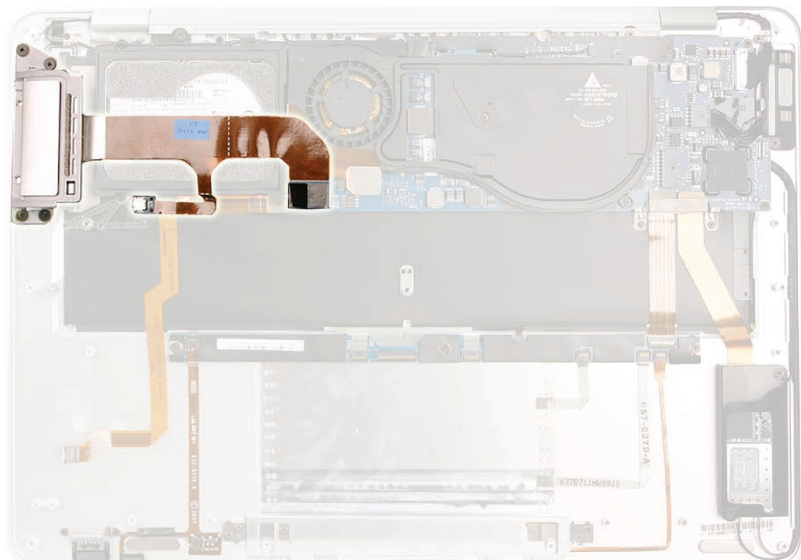

Procedure

1. Remove four #00 Phillips shoulder screws on the port hatch.

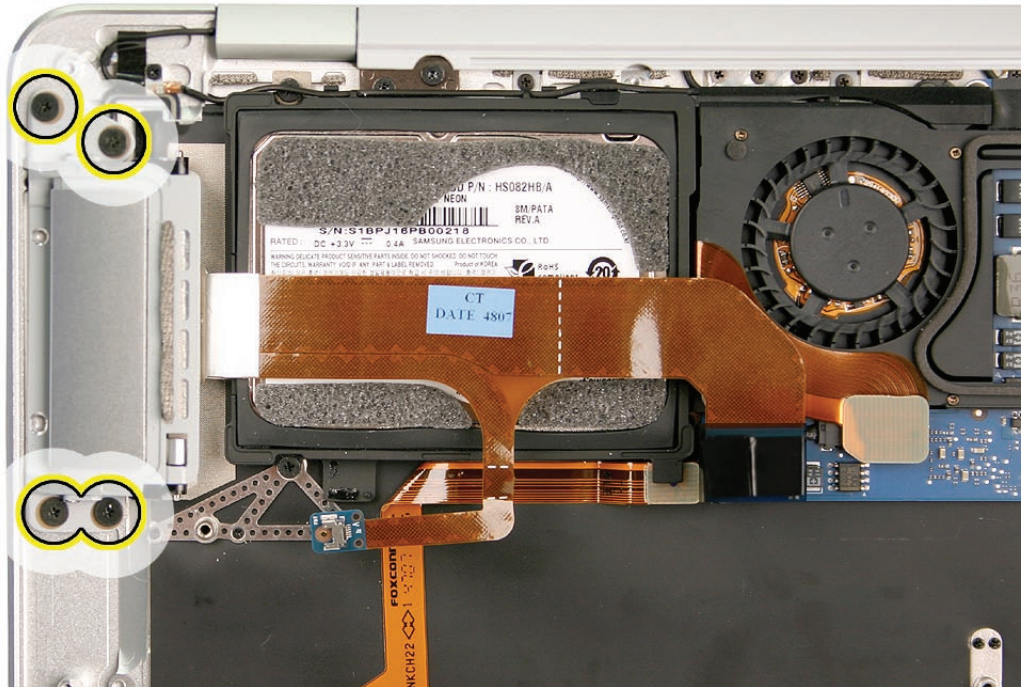

2. Note the location of the port hatch flex cable connector to the logic board.

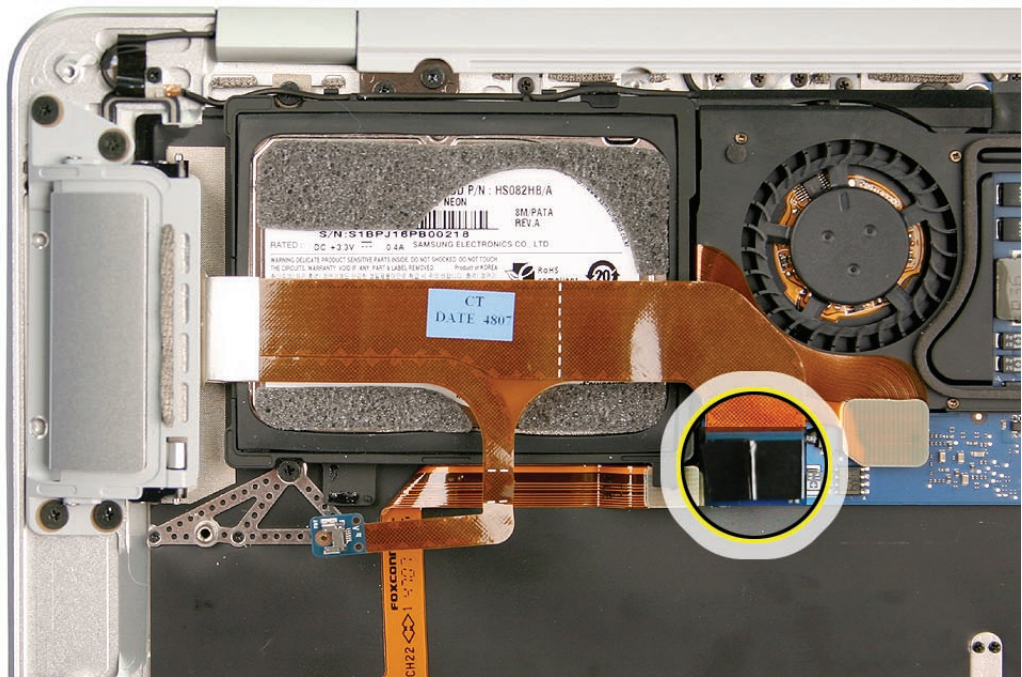

3. Lift the port hatch flex connector using the small tab on the right side to lift this connector straight up (not rocked back-and-forth or side-to-side), keeping the connector parallel to its mate to avoid damage to the connector pins.

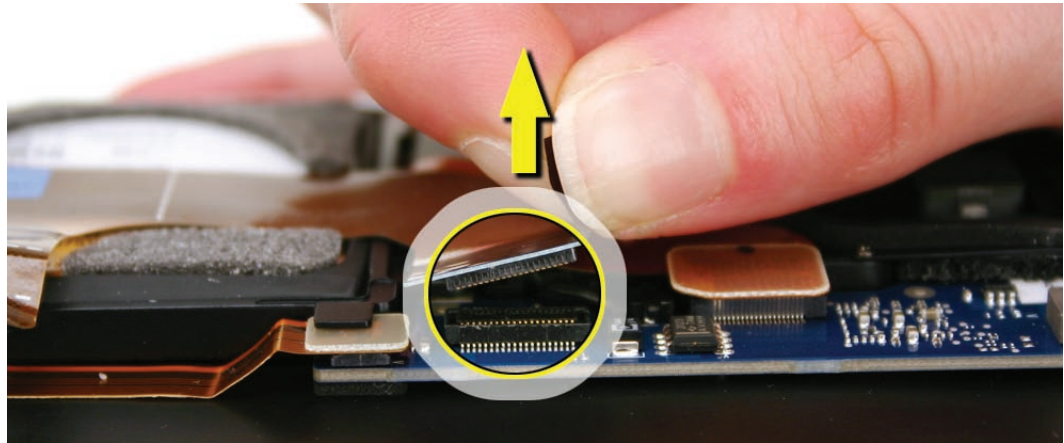

Replacement Notes

Note: Make sure the port hatch flex connector is horizontally straight and flush on the same plane as the logic board. Firmly press down the entire connector to reinstall.

Note: Do not overtighten the screws that secure the port hatch assembly. Keep in mind that these shoulder screws are designed to provide room for the component to have a bit of play in its position on the top case. A small amount of lateral movement after assembly is expected.

Quick Test

Check all the I/O ports (especially audio-out) to verify port hatch flex and audio jack connections.



MagSafe Assembly

Tools

This procedure requires the following tools:

- #00 and #000 Phillips screwdrivers (magnetized)
- Black stick (nylon probe 922-5065) or other non-conductive nylon or plastic flat-blade tool
- Multi-compartment screw tray (such as a plastic ice cube tray)

Preliminary Steps

This procedure requires placing the unit upside down on its display housing. Always use a clean, debris-free static mat to avoid scratches and other cosmetic damage to the unit.

Before you begin, remove the following:

- Bottom case
- Battery



CAUTION: The battery **must** be disconnected from the logic board before proceeding further. Failure to do so is likely to result in irreparable damage to expensive components such as the logic board and/or LVDS cable.

Part Location

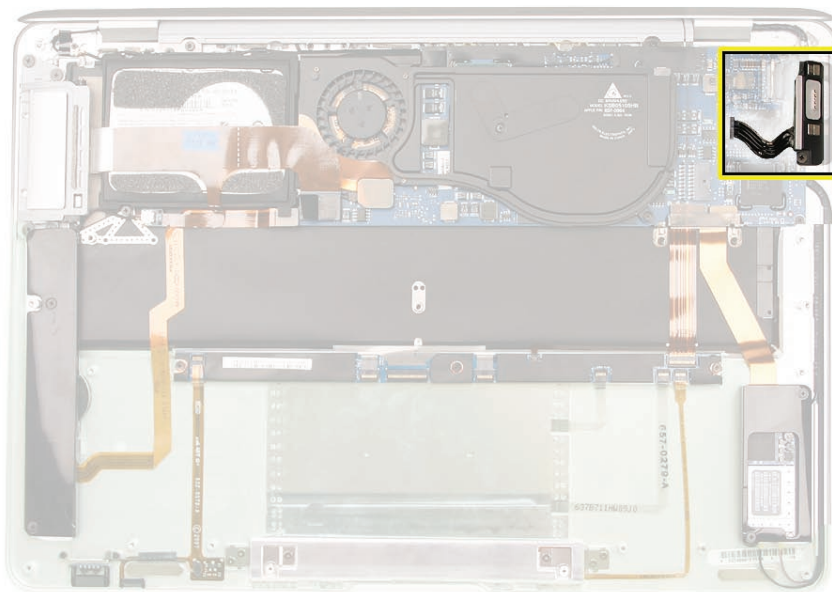

Procedure



CAUTION: The battery **must** be disconnected from the logic board before proceeding further. Failure to do so is likely to result in irreparable damage to expensive components such as the logic board and/or LVDS cable.

1. Remove the Phillips #000 screw that secures the LVDS cable ground clip.

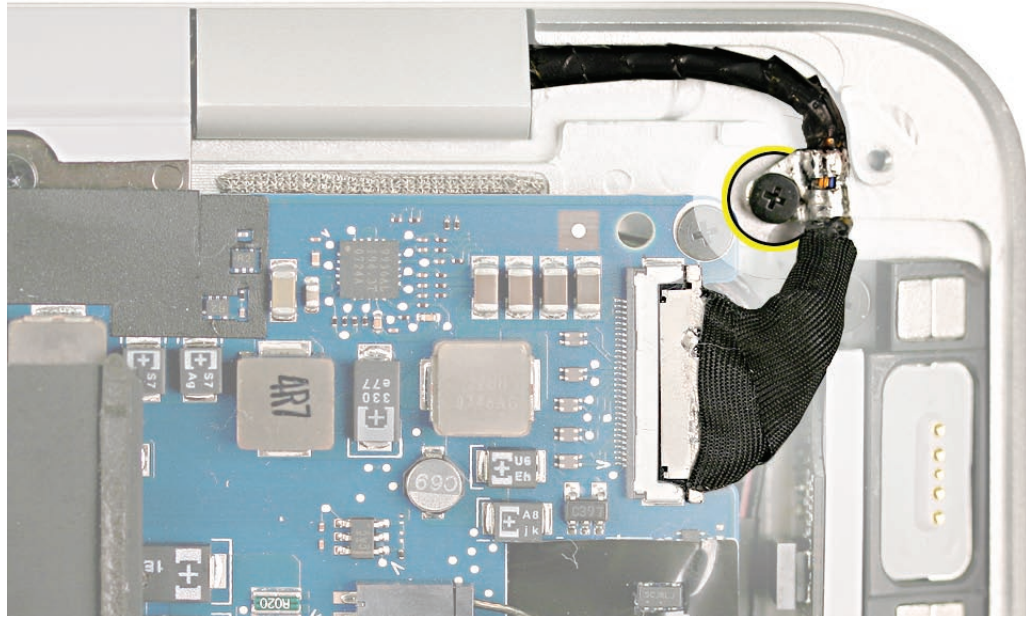

2. With your fingers or a black stick, disconnect the LVDS cable using the tabs on either side of the connector. Be sure to keep the connector level—horizontally parallel to the logic board.

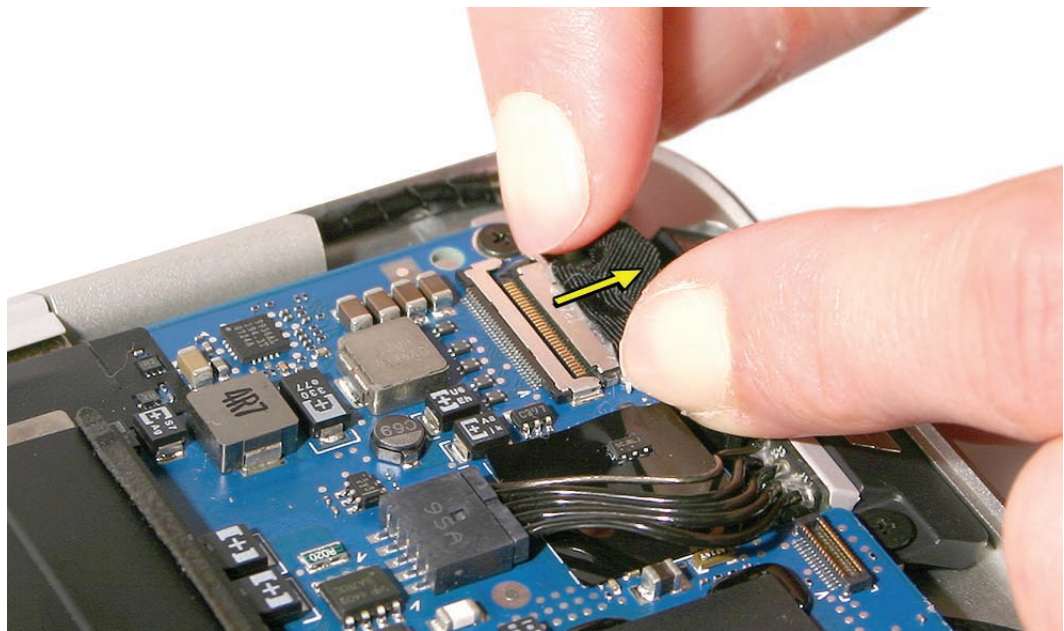

3. Remove the two Phillips shoulder screws that hold down the MagSafe assembly.
4. Disconnect the MagSafe cable by sliding a black stick under the cabling right next to the connector and sandwiching the connector between the black stick and your thumb. Be sure to keep the connector flat (i.e., horizontally parallel to the logic board). Be careful that the individual cables don't get bent, damaged or misaligned.

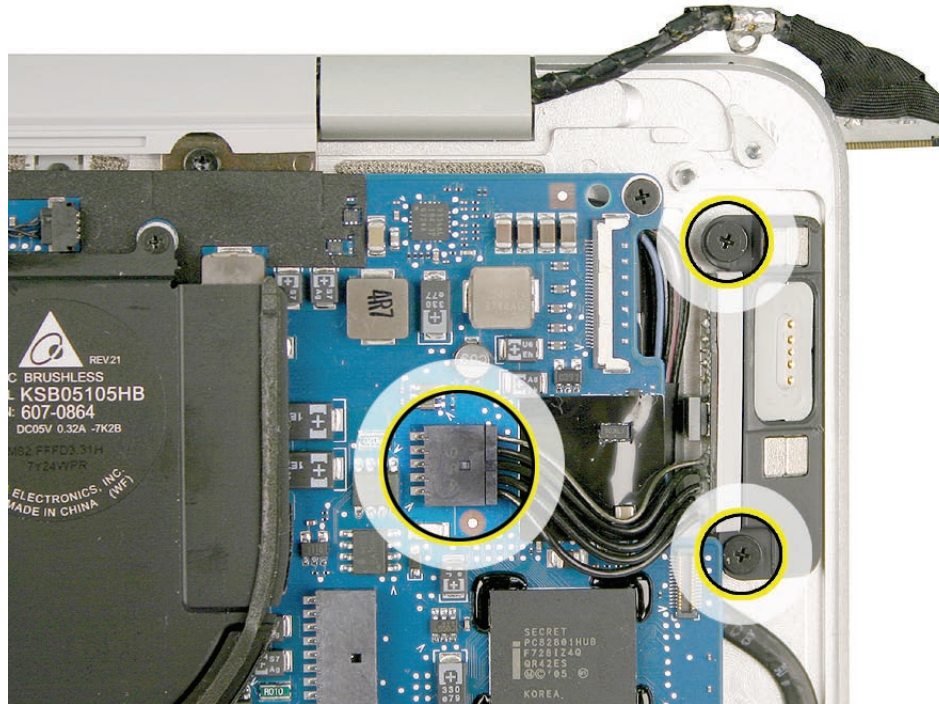

Reassembly Tips

- The magnets on the MagSafe assembly are strong and can quickly attract metal screws. When reinstalling the MagSafe assembly, use your fingers or perhaps tweezers to hold the screws in place while turning the screwdriver.
- Do not overtighten the screws that secure the MagSafe assembly. Keep in mind that these shoulder screws are designed to provide room for the component to have a bit of play in its position on the top case. A small amount of lateral movement after assembly is expected.

Quick Test

Attach a MagSafe adapter DC plug to the MagSafe port to see if the LED turns amber or green, depending on the level of battery charge in the unit.



Hard Drive

Tools

This procedure requires the following tools:

- #00 and #000 Phillips screwdrivers (magnetized)
- Black stick (nylon probe 922-5065) or other non-conductive nylon or plastic flat-blade tool
- Multi-compartment screw tray (such as a plastic ice cube tray)

Preliminary Steps

This procedure requires placing the unit upside down on its display housing. Always use a clean, debris-free static mat to avoid scratches and other cosmetic damage to the unit.

Before you begin, remove the following:

- Bottom case
- Battery



CAUTION: The battery must be disconnected from the logic board before proceeding further. Failure to do so is likely to result in irreparable damage to expensive components such as the logic board and/or LVDS cable.

Part Location

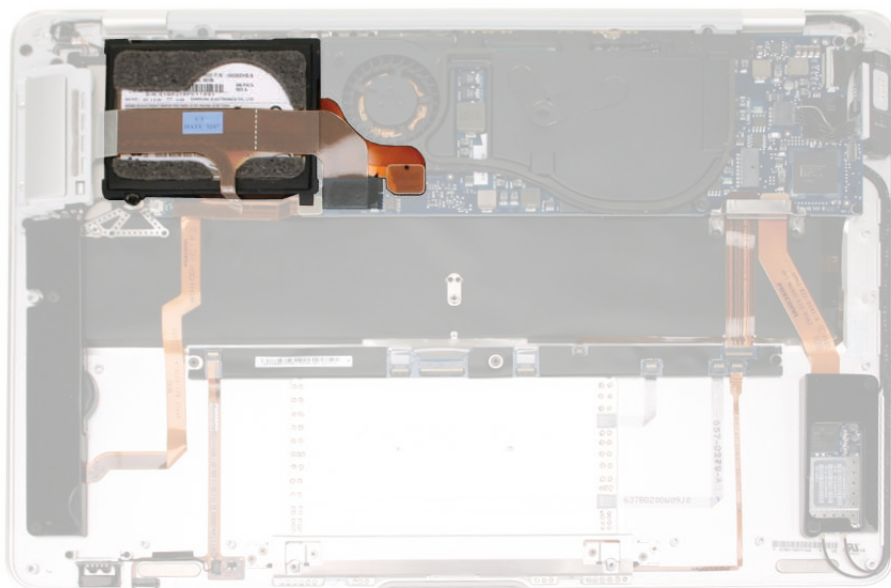

Removal Procedure

1. Identify the intersecting cables below: (1) the port hatch audio flex extension (branching off from the port hatch flex cable) which connects to (2) the audio-out cable coming from the speaker assembly on the left.

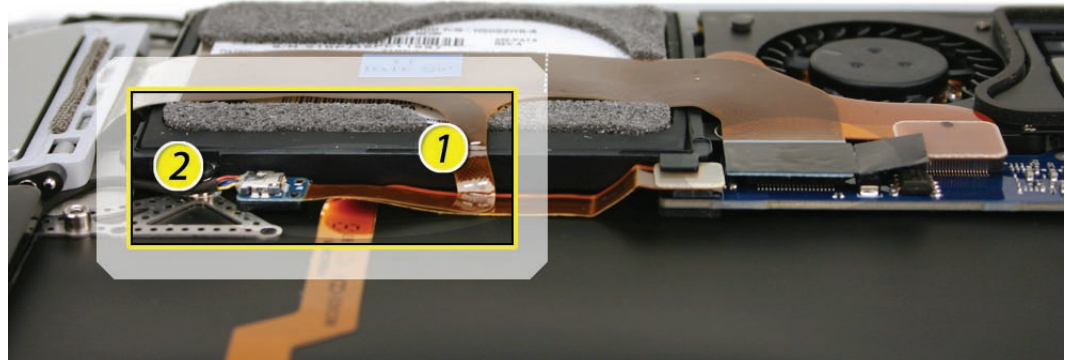

2. The port hatch audio flex extension is adhered to another flex cable on the top case (the audio flex cable between the audio board and logic board). Use the flat end of a black stick to carefully separate the top flex cable from its adhesion to the flex cable underneath.

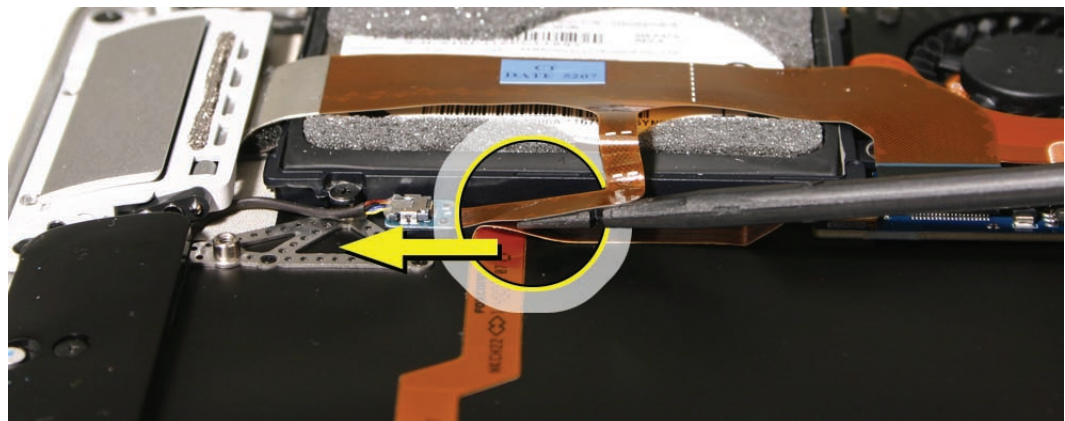

3. Pry up the small blue board at the end of the port hatch flex cable extension away from the hard drive frame, using care to preserve the adhesive for reuse.

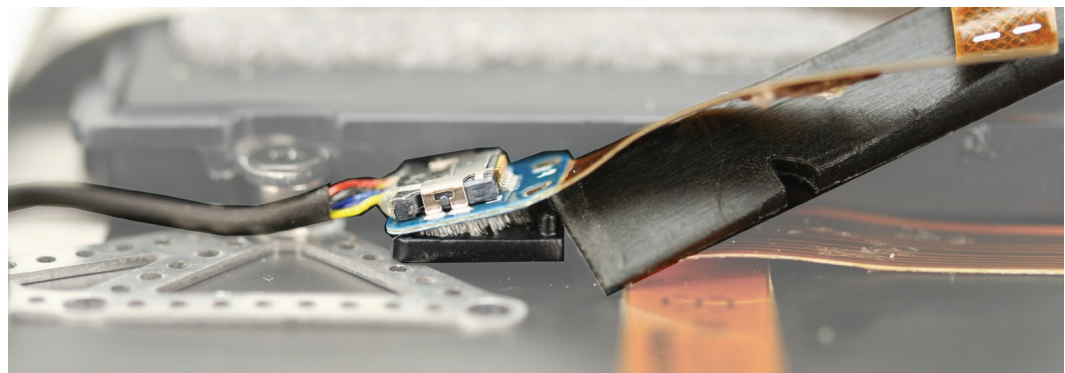

4. Lift the cables away from the hard drive frame and disconnect the audio-out cable on the left from the port hatch flex extension on the right.

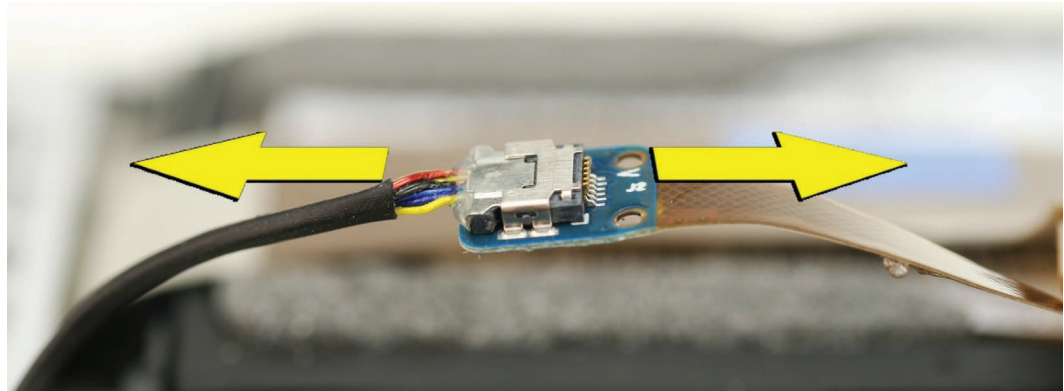

5. Locate the port hatch flex cable connector to the logic board.

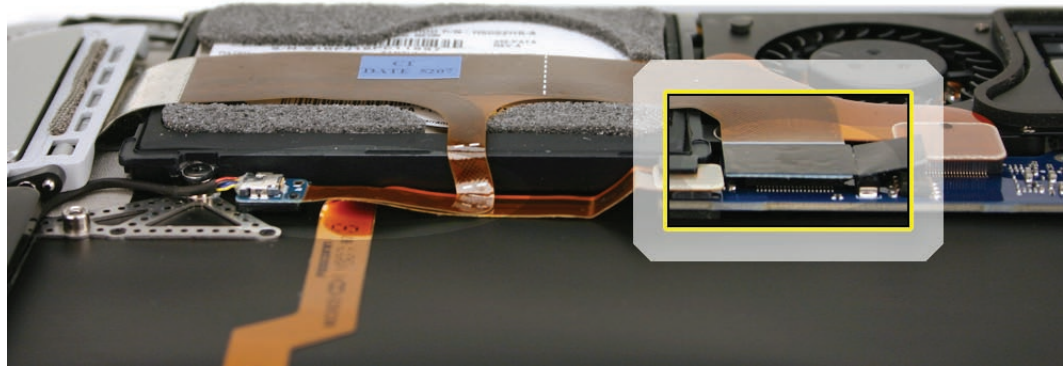

6. Lift the port hatch flex connector using the small tab on the right side to lift this connector straight up (not rocked back-and-forth or side-to-side), keeping the connector as parallel to its mate as possible to avoid damage to the connector pins.

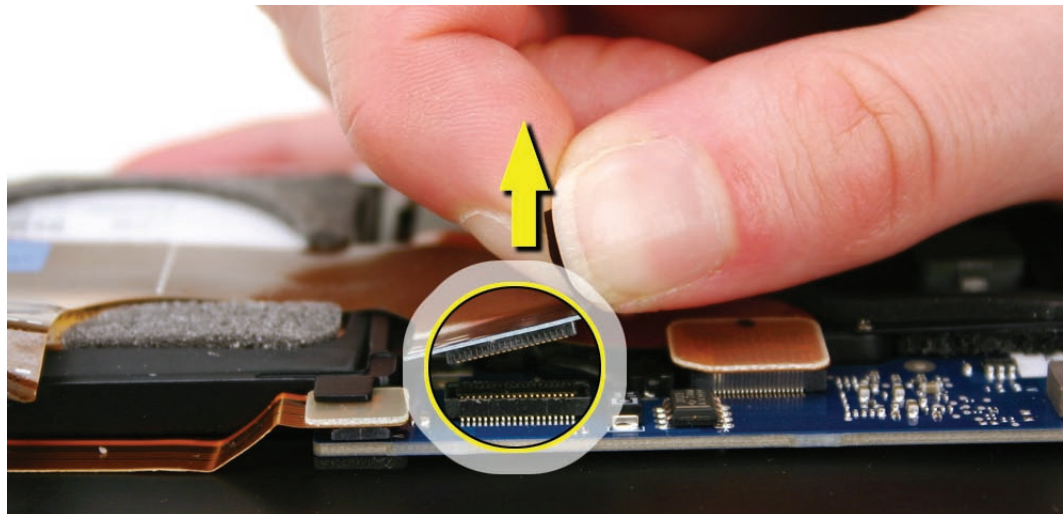

7. On the reverse side of the hard drive assembly, examine the routing to the microphone cable through channels on the hard drive frame and under the thermal module fan.



Note: Notice two black plastic cosmetic pieces designed to prevent screws and cabling from being visible through vent holes in the bottom case—one molded to fit the edge of the fan and a smaller piece molded to fit the hard drive frame. You will remove them in this procedure.

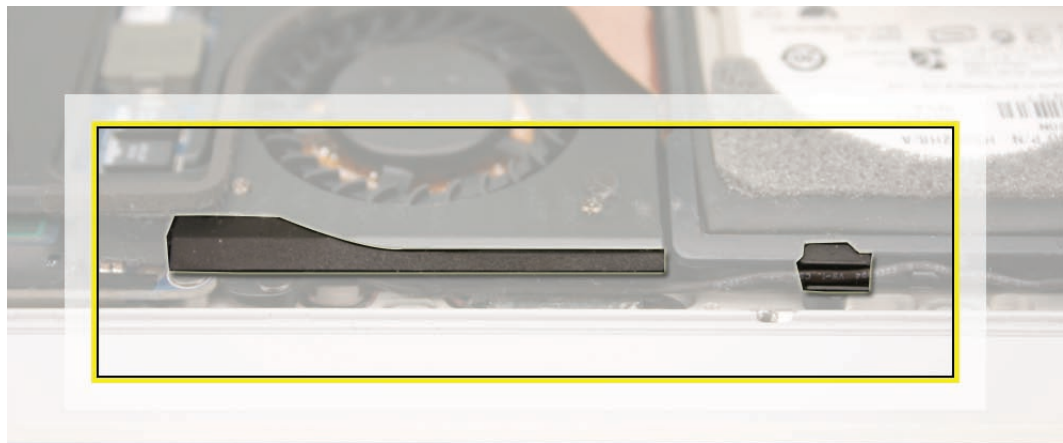

8. Begin to remove the cosmetic fan cover using a black stick to wedge it out from the left side.

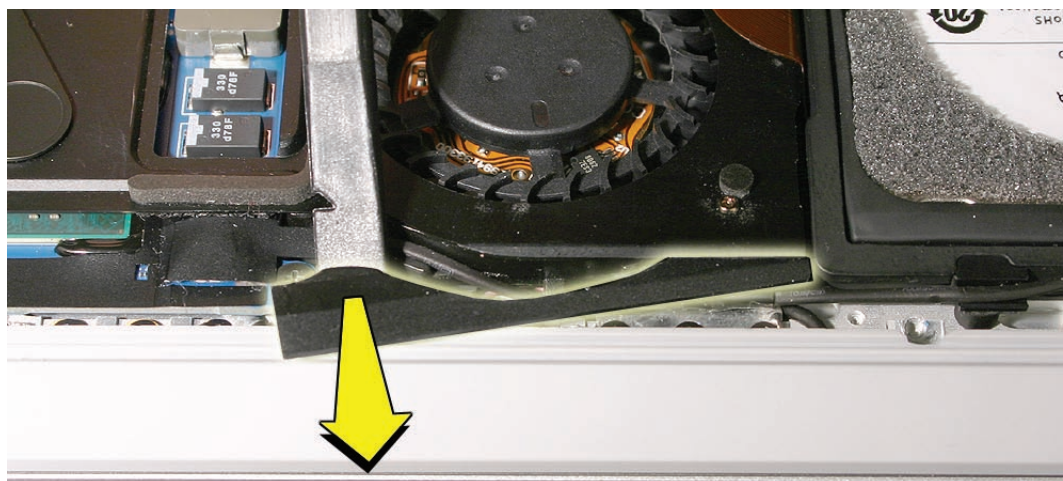

- Grab the cosmetic fan cover, pivoting outward. Pull the cover out from under the fan at the angle shown below. Note the placement of the cover for reinstallation.

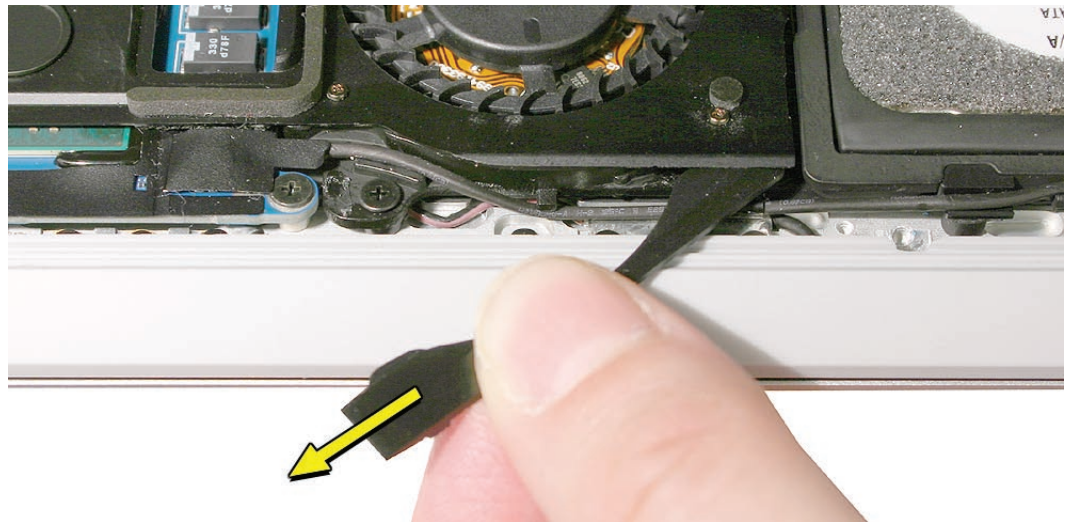

- With the cosmetic fan cover removed, lift the mylar tab shown below to expose the microphone cable's connection to the logic board.

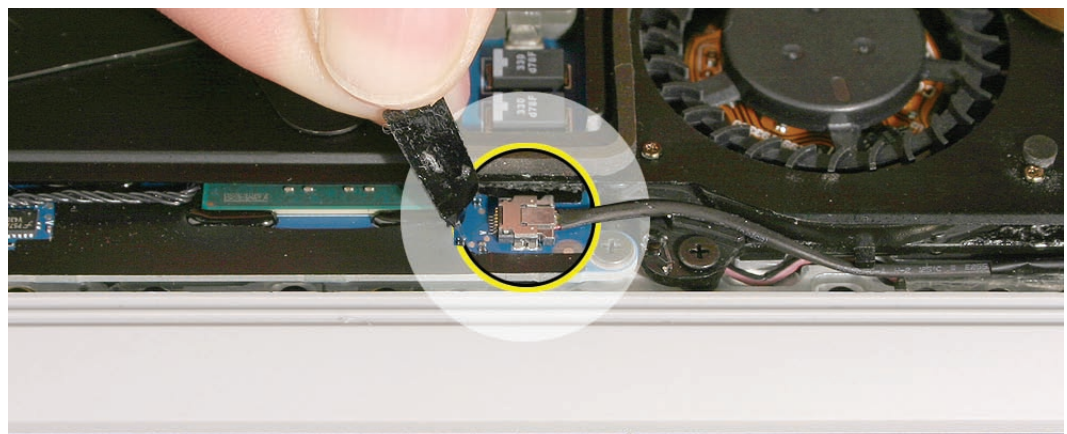

- Disconnect the microphone cable connector from the logic board using the pointed end of the black stick to push the side tabs on the connector.

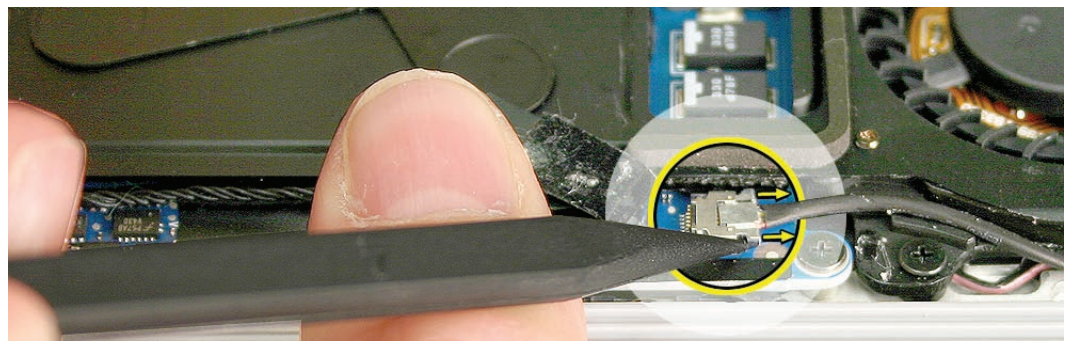

12. Note the cable routing under a clip on the fan and two sets of clips on the hard drive frame.



13. Carefully extract the microphone cable from the routing clips on the hard drive frame. Because it is delicate, take great care not to pinch or pull this cable.



14. Remove the grounding screw that secures the microphone cable to the top case.

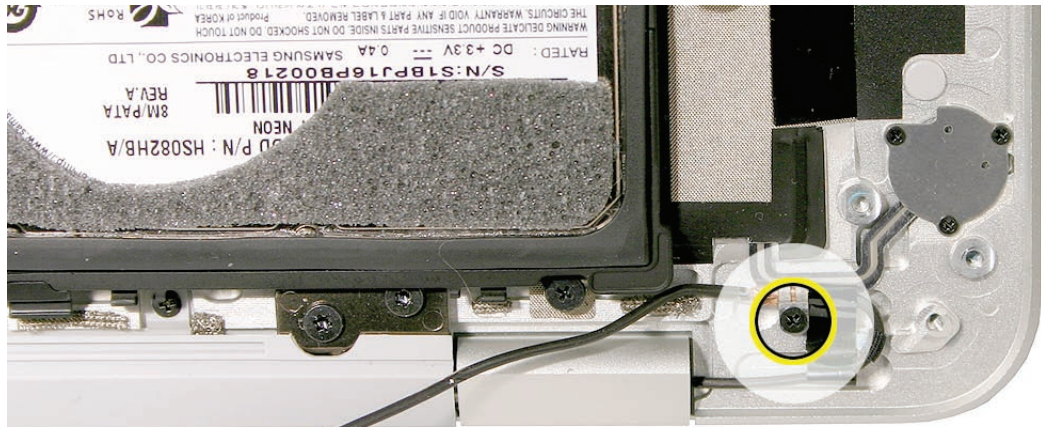

15. Remove the cosmetic screw cover on the hard drive frame using a black stick to work it outward from the frame. Keep the adhesive on the plastic piece rather than the screw, if possible. Set aside this small cosmetic screw cover with your hard drive screws.

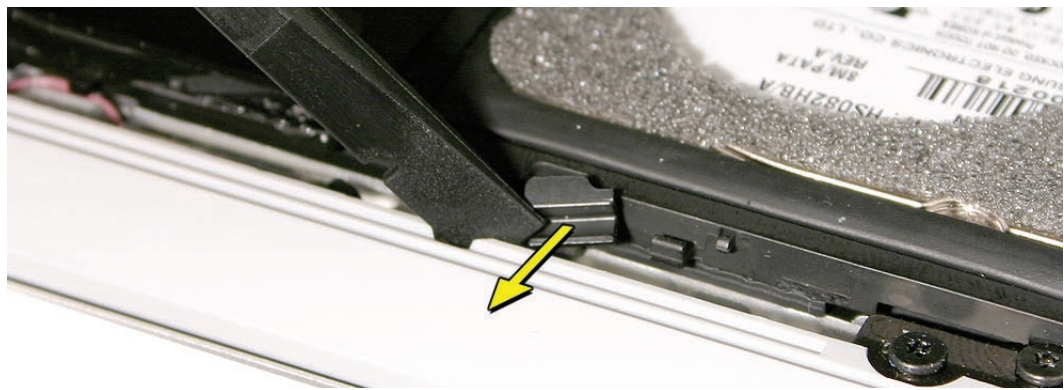
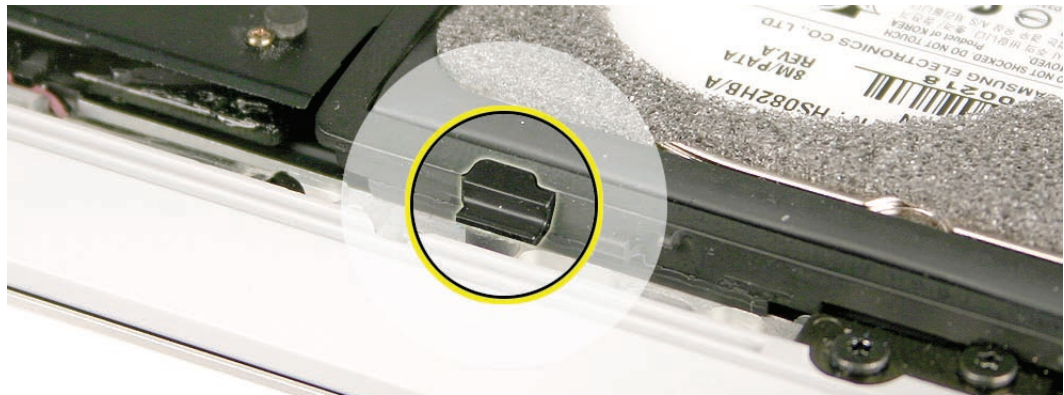

16. Remove the four Phillips screws from the hard drive bracket. Disconnect the hard drive flex cable to the logic board. (Note that unlike the photo below, the port hatch assembly need not be removed to remove the hard drive.)

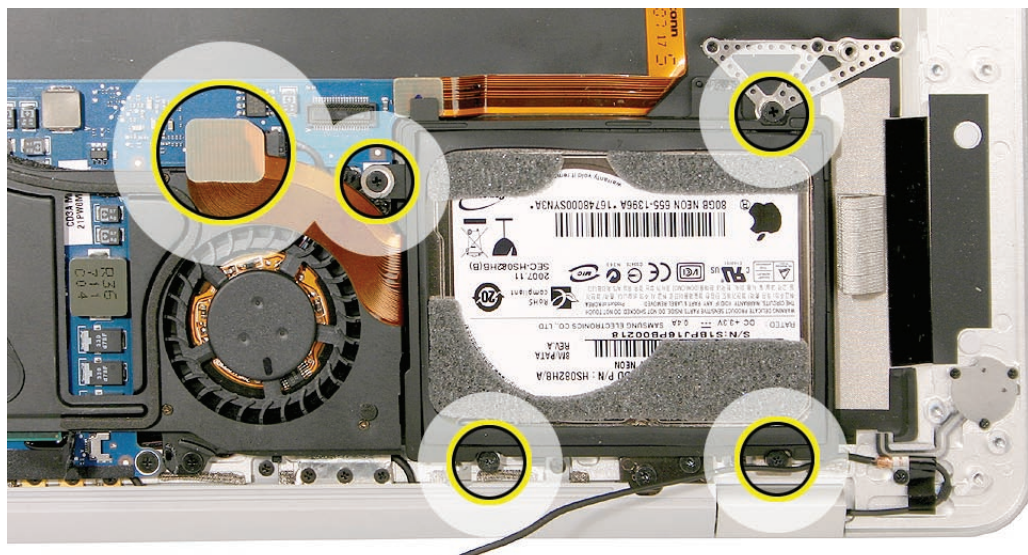

17. Lift up the hard drive frame an inch or so on the logic board side, pivoting toward the outside of the top case.

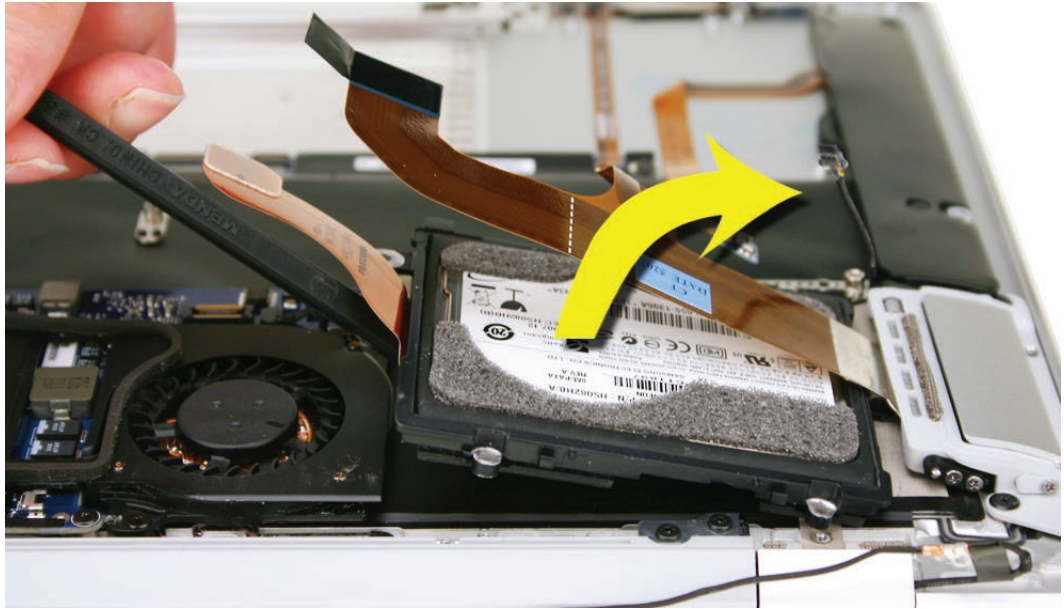

18. Remove the hard drive assembly at an angle, out from under the port hatch assembly flex cable, being careful not to bend or strain the cable.

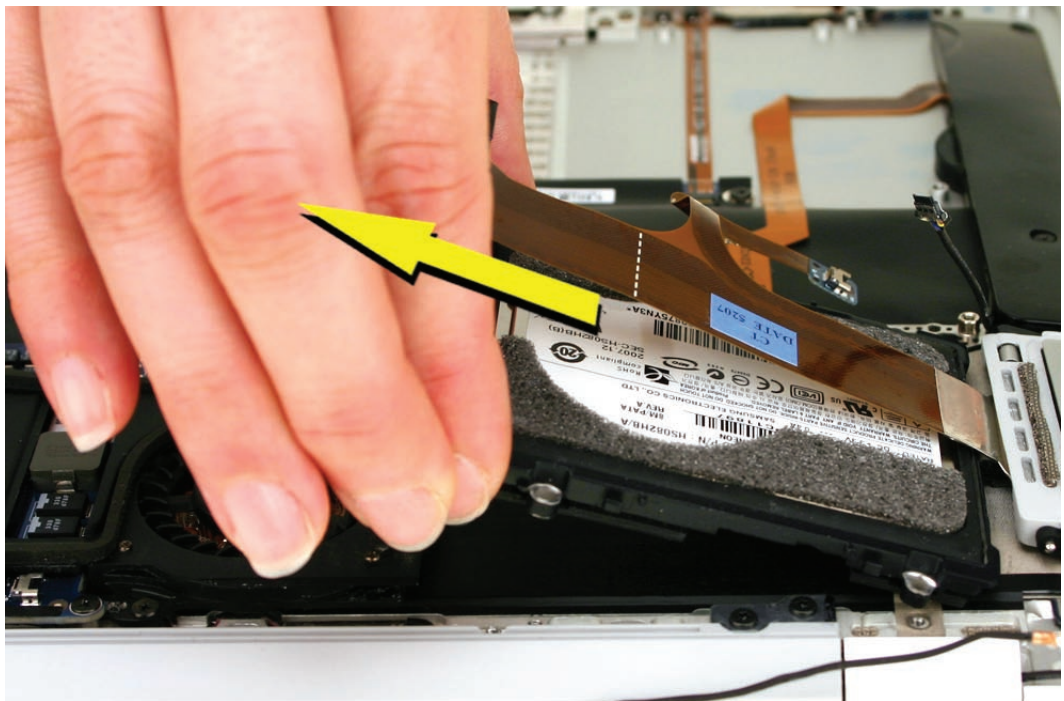

-
19. The ZIF (zero insertion force) cable connector to the hard drive is very delicate and has a limited insertion life. Use extreme care when connecting or disconnecting this cable.

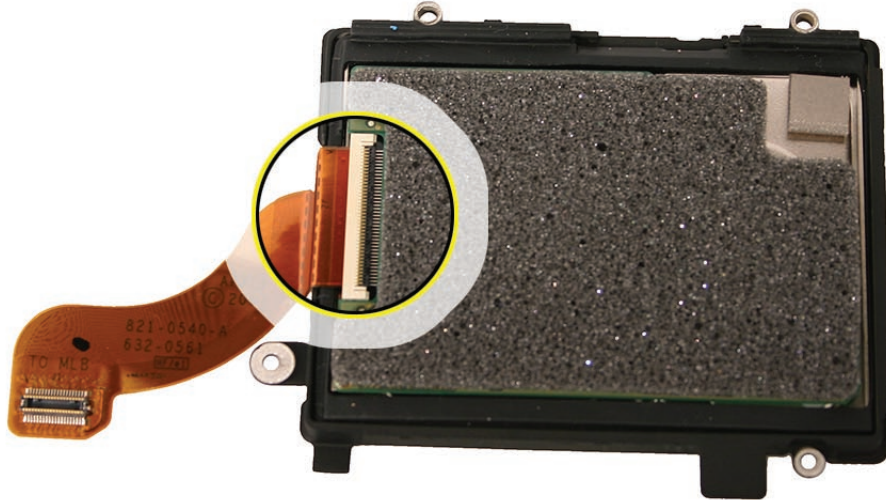

20. Carefully release the small black ZIF connector lever with a black stick.

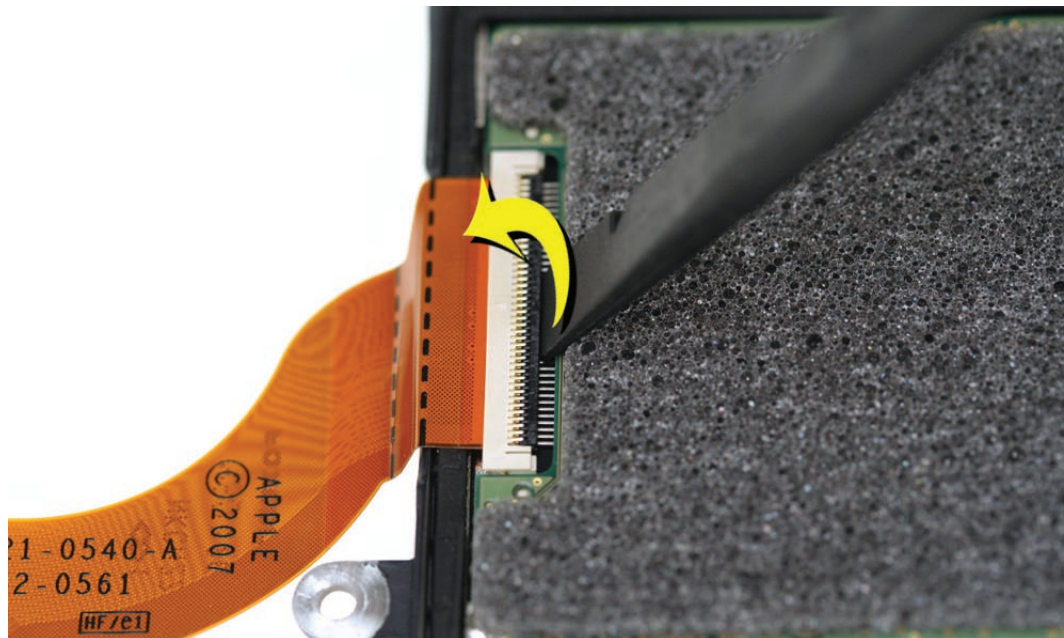

21. Gently remove the flex cable from the hard drive connector.

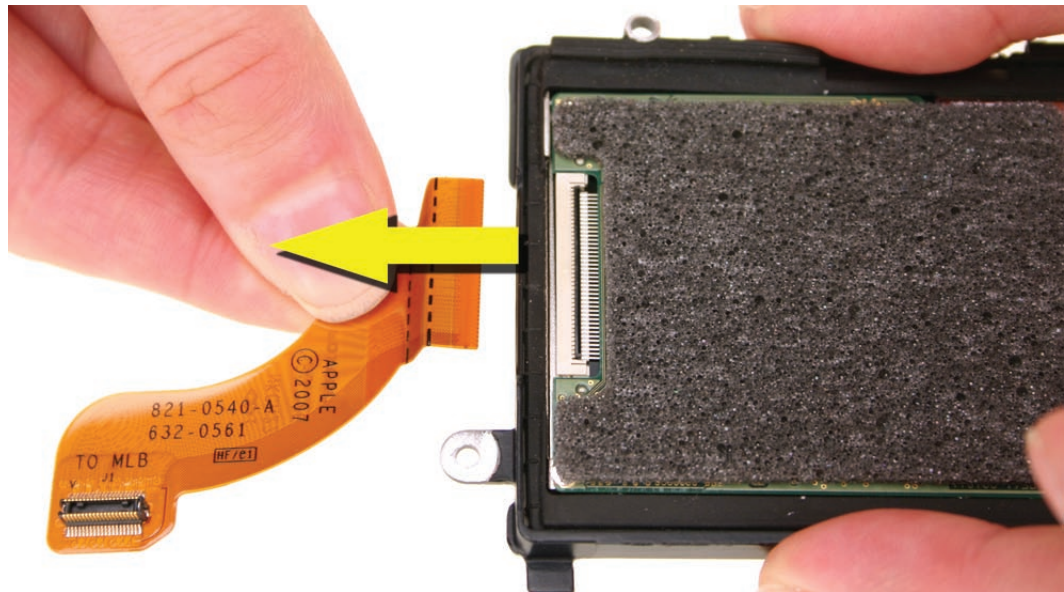

Caution: If the hard drive flex cable should become dislodged or removed during repair, you must replace the flex cable.

Replacement Notes

Reassembly is an exact reversal of the above procedure. Take care to connect all flex cables fully, and be sure to seat the audio-out cable connector board over the pin on the hard drive frame.

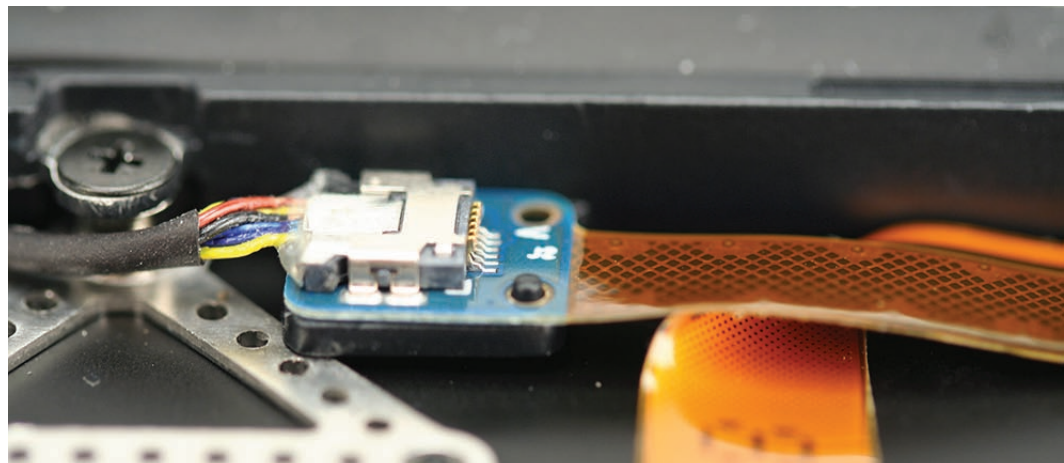

Quick Test

Start up the computer to verify that it recognizes and starts up from the hard drive.



Thermal Module

Tools

This procedure requires the following tools:

- #00 and #000 Phillips screwdrivers (magnetized)
- Black stick (nylon probe 922-5065) or other non-conductive nylon or plastic flat-blade tool
- Multi-compartment screw tray (such as a plastic ice cube tray)

Preliminary Steps

This procedure requires placing the unit upside down on its display housing. Always use a clean, debris-free static mat to avoid scratches and other cosmetic damage to the unit.

Before you begin, remove the following:

- Bottom case
- Battery
- Hard drive assembly



CAUTION: The battery **must** be disconnected from the logic board before proceeding further. Failure to do so is likely to result in irreparable damage to expensive components such as the logic board and/or LVDS cable.

Part Location

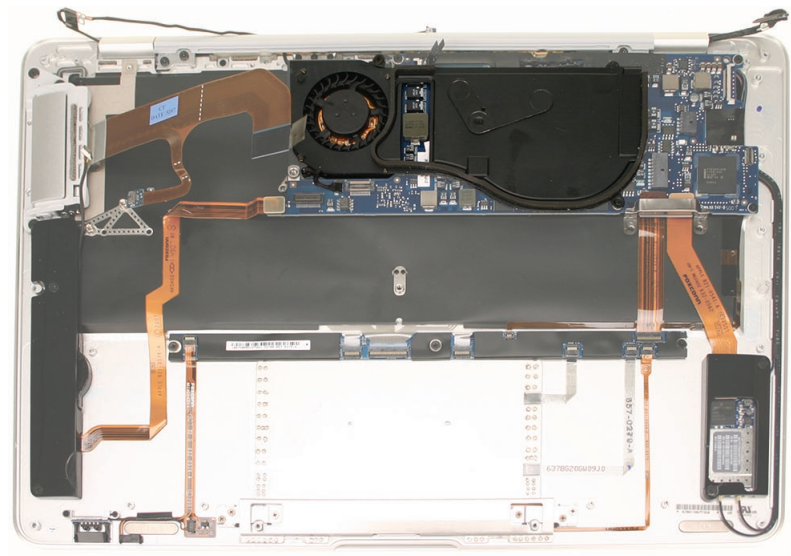

Removal Procedure

1. Remove one #00 (upper left) and three #000 (center and right) Phillips screws. The center screw also removes a boomerang-shaped clamp that secures the thermal module to the both processors. Set the boomerang clamp aside with the screws.

Note: The fan cable connection to the logic board is circled in orange.

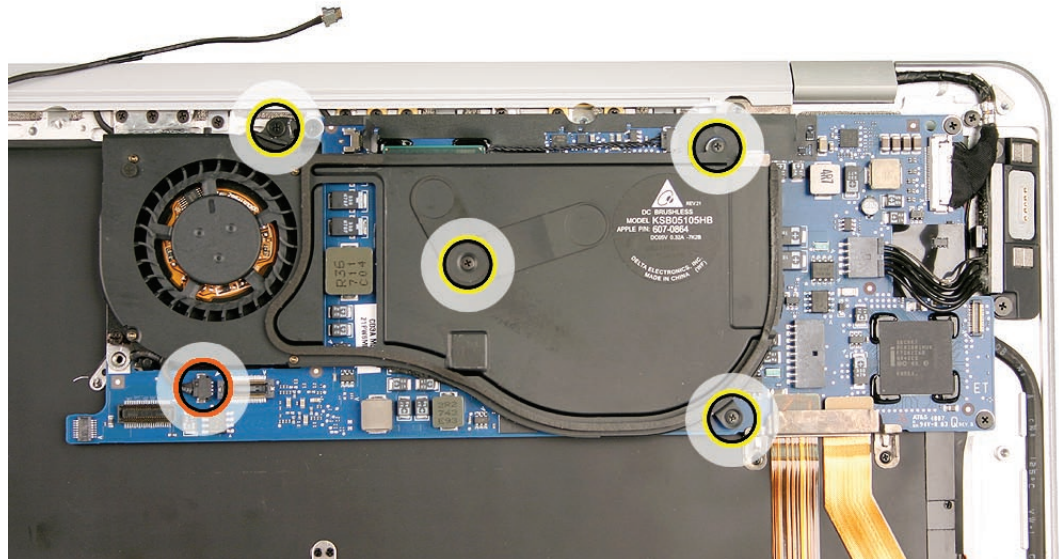

2. Disconnect the fan cable from its connection to the logic board. Insert the black stick into the small square recess on the connector to push it out of its mate.

Note: This cable and connector are delicate. Handle with care.

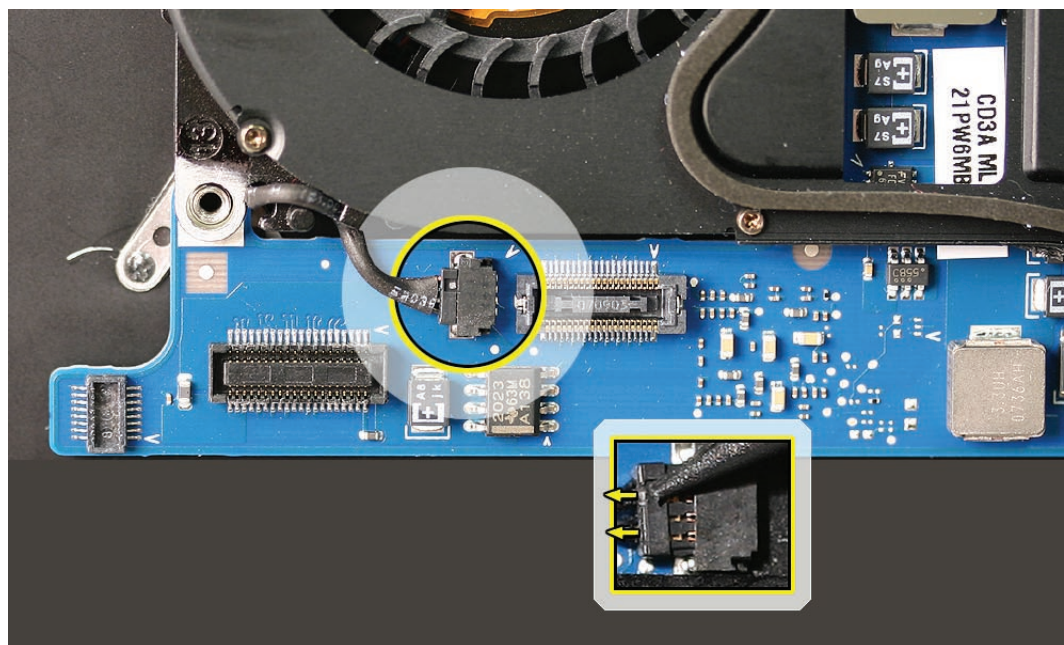

3. Gently lift the thermal module up from the logic board. You should feel a slight resistance when pulling up as the thermal paste releases. Hold the module firmly by the edges only.

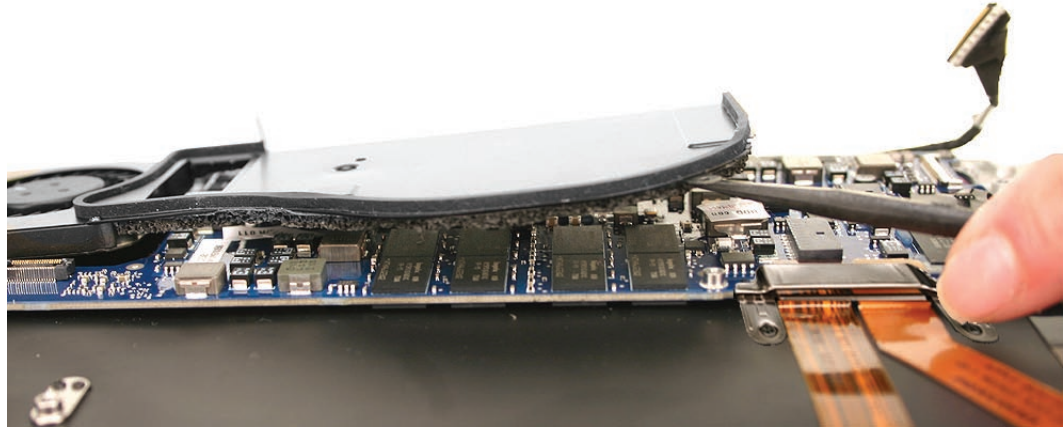

4. Hold the module by the edges only.



Warning: Whenever the thermal module is separated from the logic board (even if you are reinstalling the same logic board and/or thermal module), the thermal paste **must** be replaced. Failure to do so can cause the computer to overheat and incur damage.

Replacing the Thermal Paste

If the thermal module will be reinstalled and/or the existing logic board will remain in place, the old thermal paste must be removed from both modules, and new thermal paste applied.

1. Use a black stick to remove as much thermal paste as possible from the logic board chips.

Important: Use extreme care not to damage the chip or logic board components.



2. Use a black stick to remove thermal paste from the two mating pads on the under side of the thermal module.



3. Use an alcohol wipe to completely clean the residual thermal paste from the two chips on the logic board and the two pads on the heatsink.

Important: Use extreme care not to damage the logic board components.

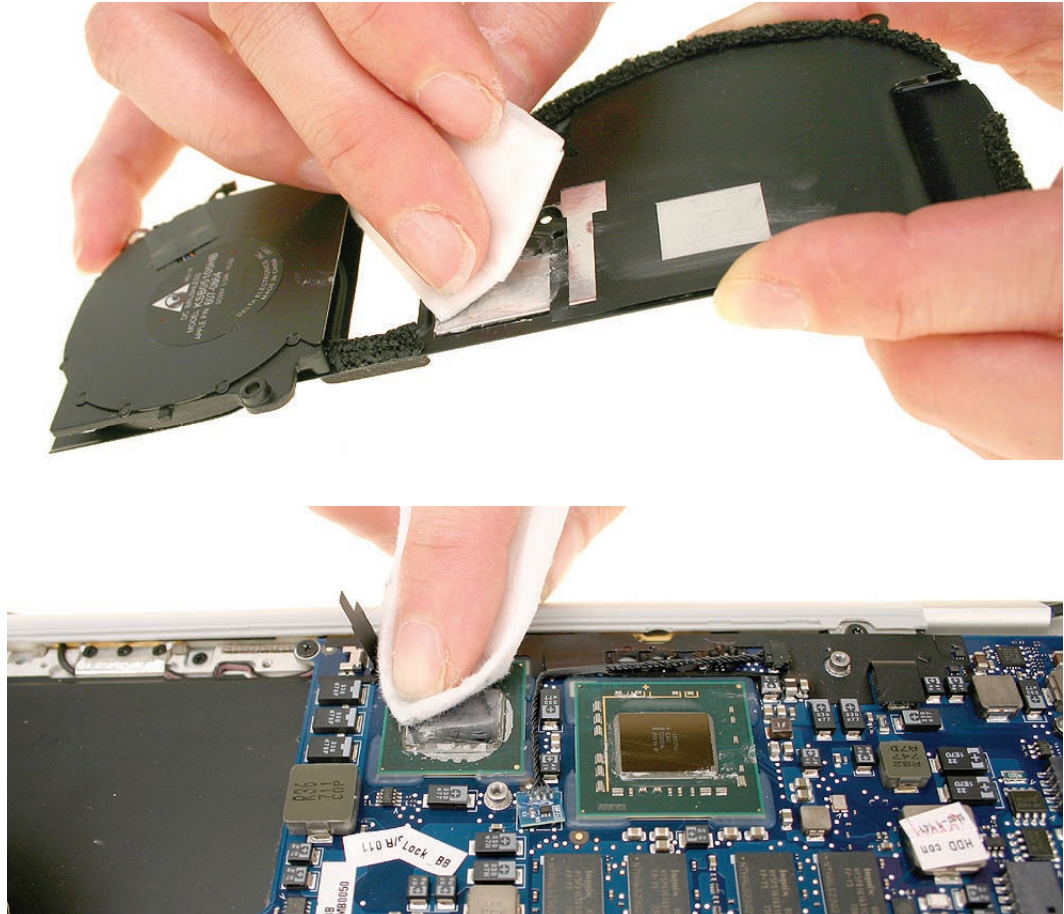

Note: Apple part no. 922-7144 contains one alcohol wipe and three thermal paste syringes.



- Note the contents of the syringe of thermal paste.

Important: One syringe (922-7144) contains enough paste for four chips (two repairs). Use one-quarter of the syringe contents per chip. Using a felt-tip pen, mark the 1/4 points on the syringe before applying the first dab.



Important: Avoid unnecessary contact with new thermal paste, as dirt and body oils reduce the paste's conductivity.

- Put a 1cc dab (roughly one quarter of a full syringe) of thermal paste in the center of each chip mating surface, as shown.

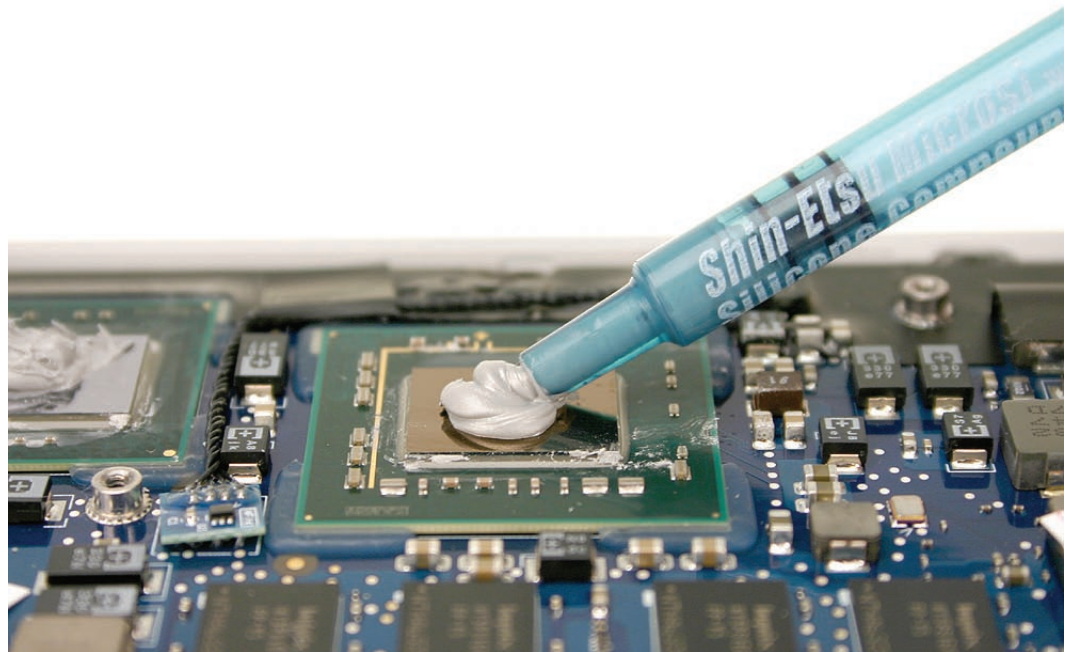

Reassembly Procedure

Caution: Before reinstalling the thermal module onto the logic board, you **MUST** have replaced the thermal paste already. See above section for instructions.

1. While centering the thermal module pads over the two chips, lower the thermal module onto the logic board.

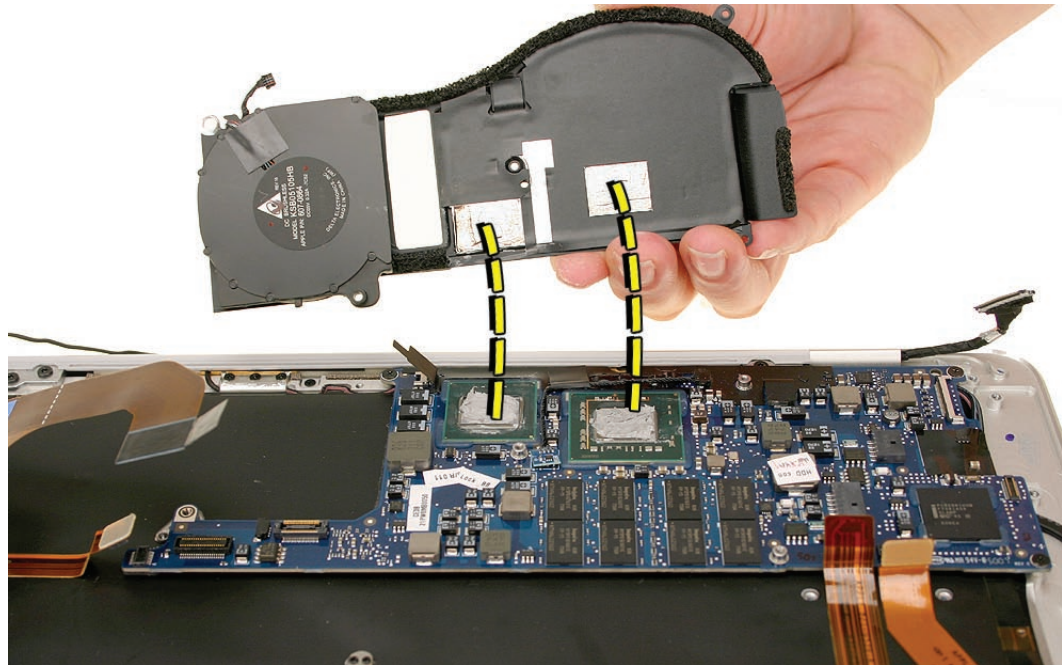

2. Verify that the thermal module screw clips are aligned with their bosses underneath, then press gently but firmly over the two chips to make sure the thermal paste adheres evenly.

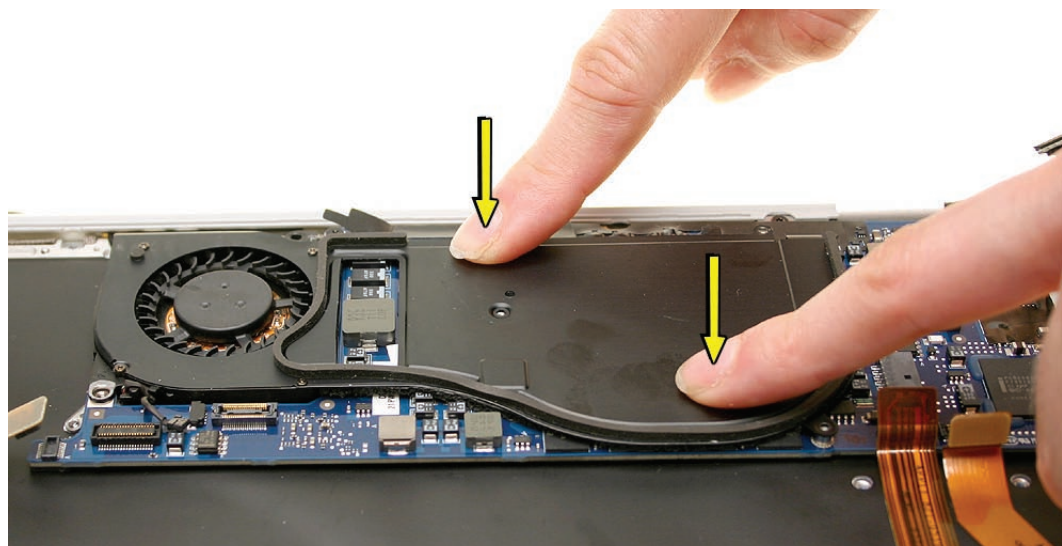

3. Set the thermal module boomerang clamp in the center of the thermal module using the screw hole for initial alignment. Then pivot the boomerang so that the small hole near the "V" of the clamp lines up with its corresponding hole in the thermal module beneath.

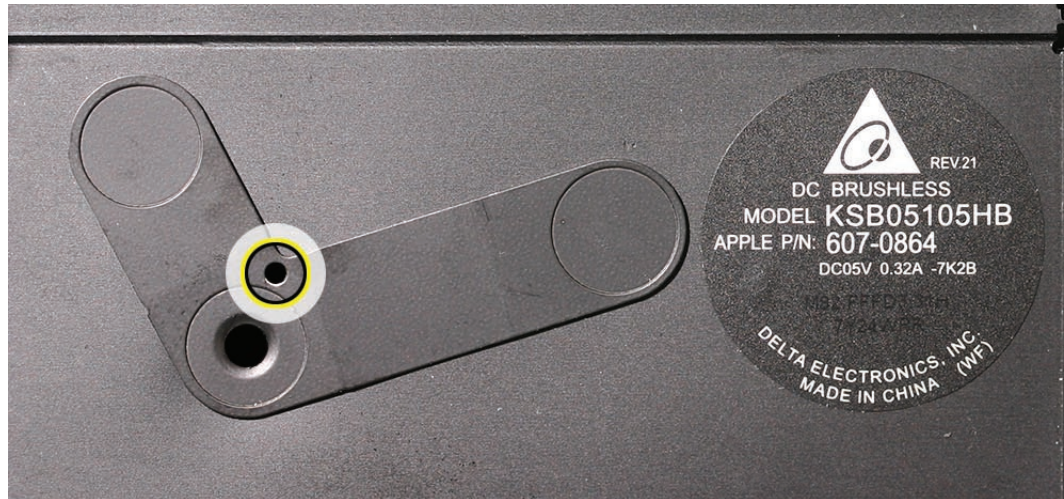

4. Install one #00 Phillips screw in the upper left corner near the fan, two #000 screws in the clips on the right upper and lower corners of the thermal module, and then fasten the center #000 screw on the boomerang clamp last. Do not overtighten the center screw.

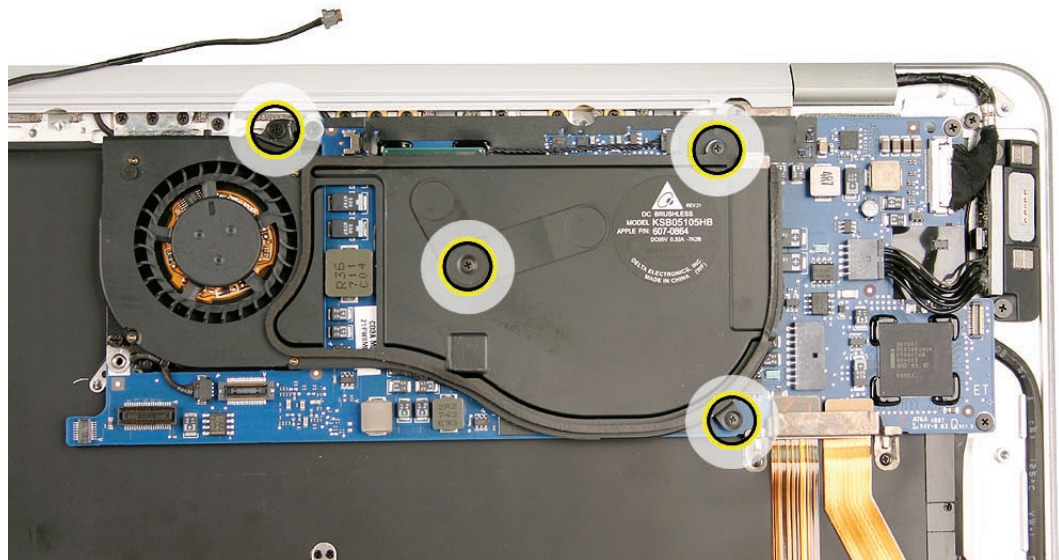

5. Connect the thermal sensor from the heatsink fan to the logic board. Pay close attention to cable routing. See picture below for more detail.

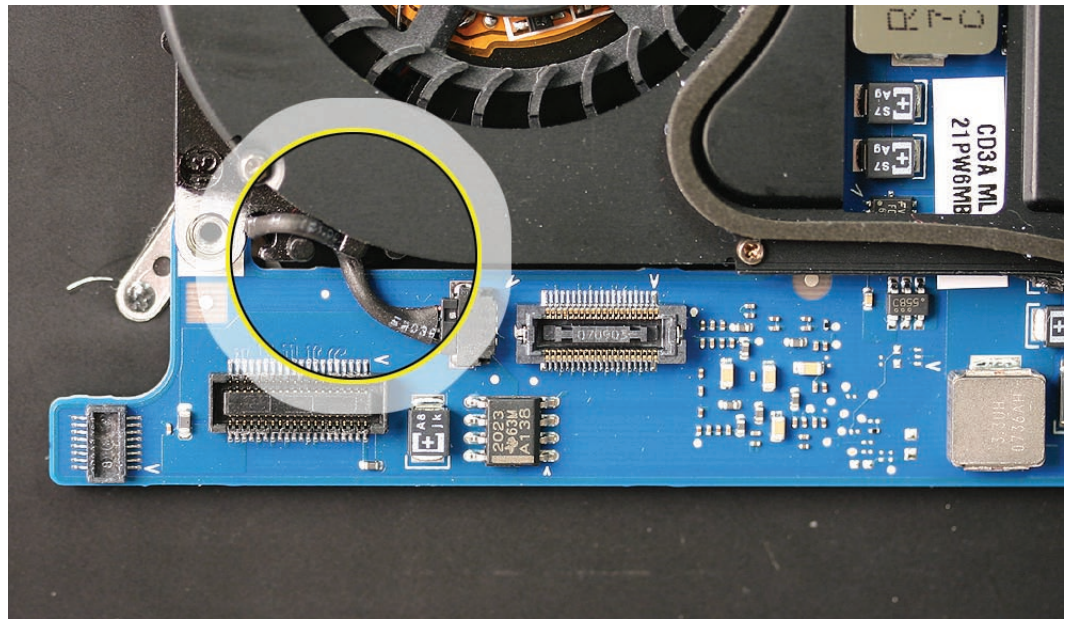

Quick Test

After reassembly, start up the computer and let the system run for a period of time until the fan comes on; then check for fan noise.



Logic Board

Tools

This procedure requires the following tools:

- #00 and #000 Phillips screwdrivers (magnetized)
- Black stick (nylon probe 922-5065) or other non-conductive nylon or plastic flat-blade tool
- Multi-compartment screw tray (such as a plastic ice cube tray)

Preliminary Steps

This procedure requires placing the unit upside down on its display housing. Always use a clean, debris-free static mat to avoid scratches and other cosmetic damage to the unit.

Before you begin, remove the following:

- Bottom case
- Battery
- Speaker assembly
- Port hatch assembly
- Hard drive assembly
- MagSafe assembly



CAUTION: The battery **must** be disconnected from the logic board before proceeding further. Failure to do so is likely to result in irreparable damage to expensive components such as the logic board and/or LVDS cable.

Part Location

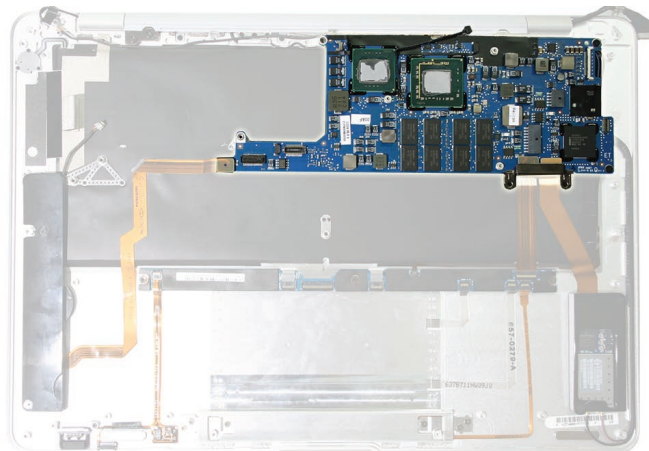

Removal Procedure

1. Remove two tiny Phillips screws that hold the flex bracket (bottom) right to the top case.

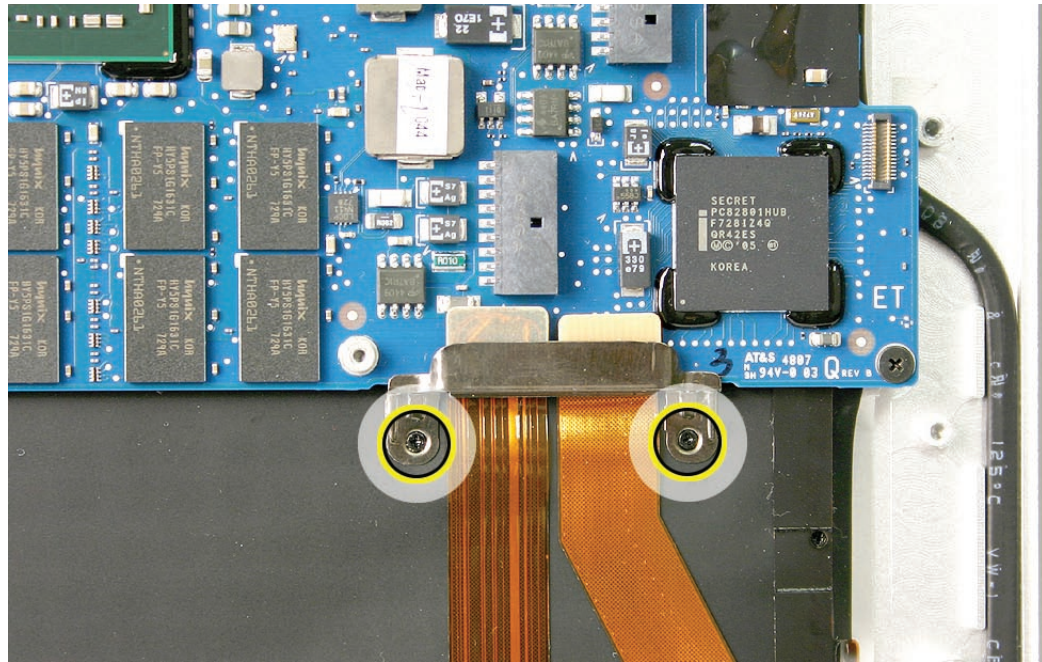

2. Remove three identical Phillips screws in the corners of the logic board and disconnect three connectors at the bottom edge—the audio cable connector, the Input Devices (IPD) board flex connector and the Airport/Bluetooth card flex connector.

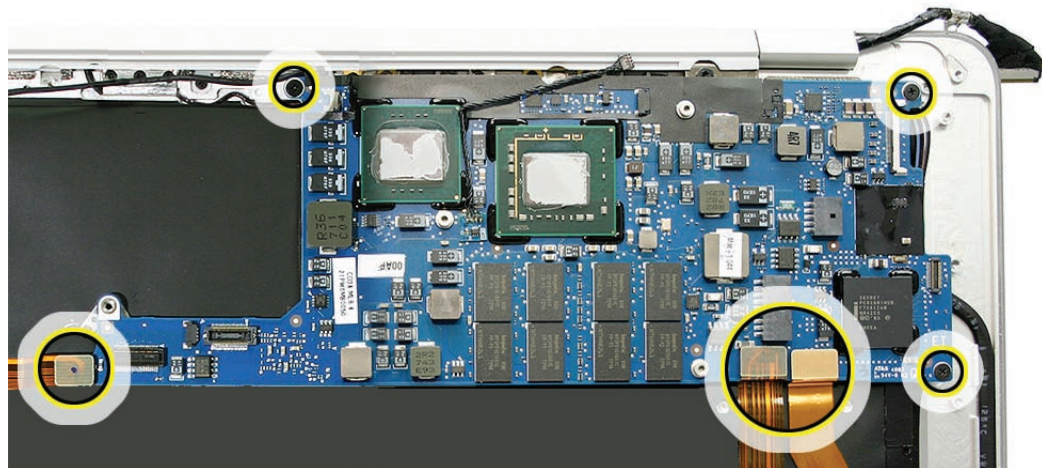

3. When removing the logic board, grasp the board in the middle lengthwise by the edges only. Do not hold the board by any narrow areas. Take all ESD precautions when handling it.

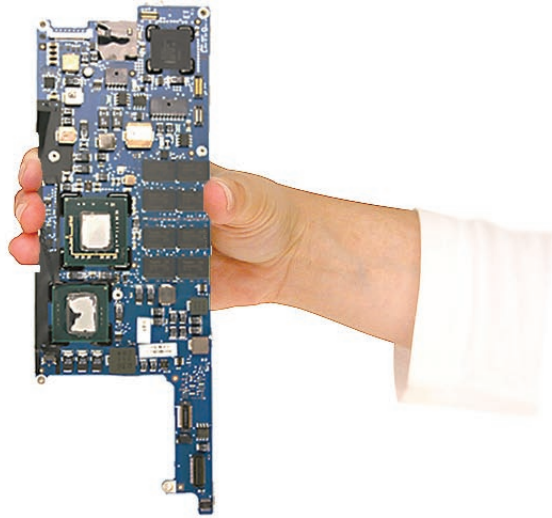

Warning: To avoid flexing the logic board, hold the board vertically along the wide sides. Do not hold the board by the ends or by the narrow neck at the fan cutout, or horizontally, as the board's weight can cause excessive flex.

4. Set logic board aside in a shielded, anti-static bag until reassembly.

Reassembly Procedure

1. Align the clip on the lower left wing of the logic board with the screw post on the top case shown below, square the logic board with the unit and gently lower it into place.

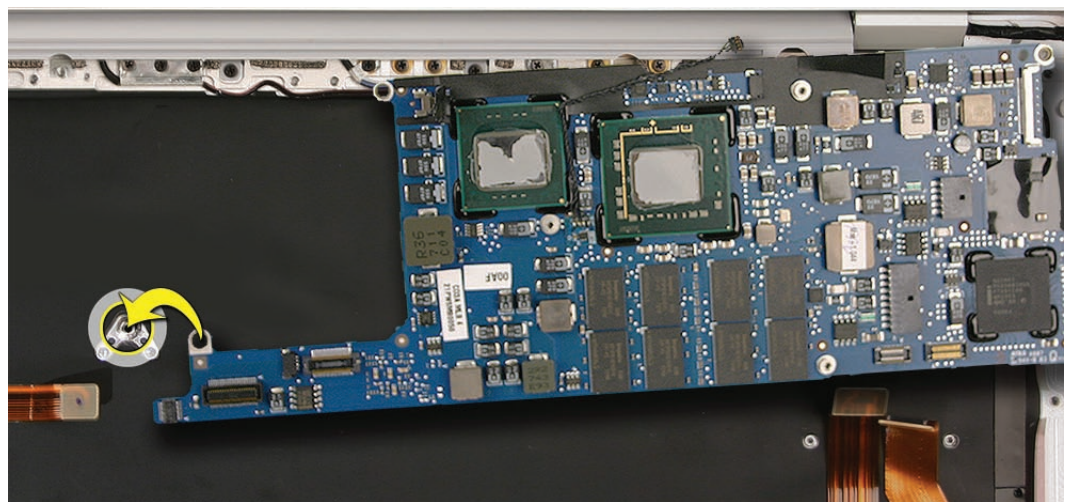

2. Install three identical Phillips screws in the order called out below.

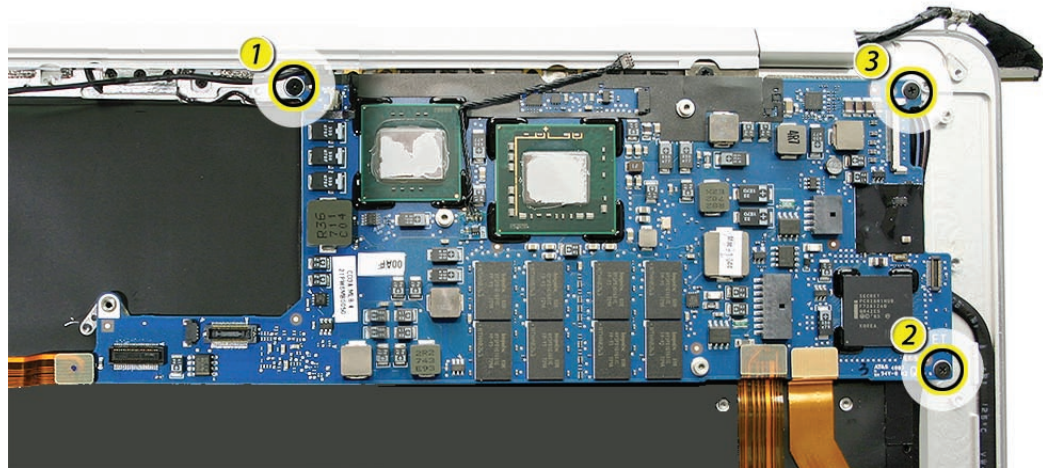

3. Carefully connect the three flex cable connectors below to their mates on the logic board.

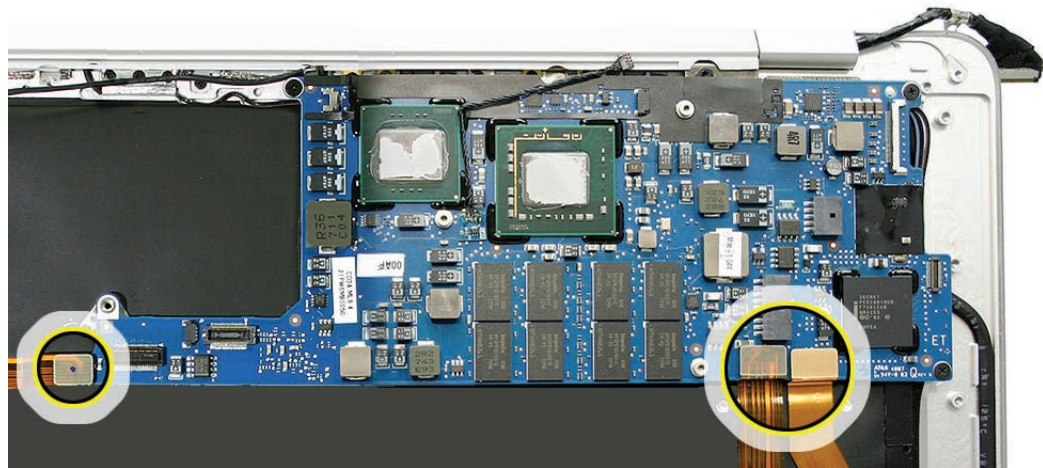

Very Important: Before installing a new thermal module or reinstalling the original one, you must clean the old thermal paste from the chips on the logic board, then reapply paste or utilize new paste on the replacement thermal module. See **How to Replace the Thermal Paste** section of the Thermal Module section preceding this one.

Quick Test

- Check keyboard response, keyboard backlight, trackpad, IR (use Apple Remote) and sleep indicator light to verify correct Input Devices (IPD) flex cable connection.
- Attach power adapter and charge battery to check that the MagSafe connector is properly connected.
- In Apple System Profiler, verify AirPort and Bluetooth presence as well as settings.
- Check all I/O ports on port hatch.



Thermal Module and Logic Board Combined

Tools

This procedure requires the following tools:

- #00 and #000 Phillips screwdrivers (magnetized)
- Black stick (nylon probe 922-5065) or other non-conductive nylon or plastic flat-blade tool
- Multi-compartment screw tray (such as a plastic ice cube tray)

Preliminary Steps

This procedure requires placing the unit upside down on its display housing. Always use a clean, debris-free static mat to avoid scratches and other cosmetic damage to the unit.

Before you begin, remove the following:

- Bottom case
- Battery
- Hard drive assembly
- Logic board flex connector bracket



CAUTION: The battery **must** be disconnected from the logic board before proceeding further. Failure to do so is likely to result in irreparable damage to expensive components such as the logic board and/or LVDS cable.

Part Location

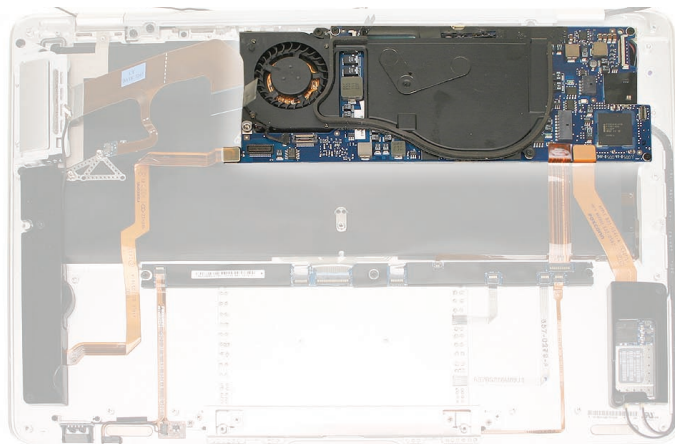

Removal Procedure

1. Remove three Phillips screws securing the logic board to the top case and one (upper-left-most) Phillips screw securing the thermal module to the top case.
2. Disconnect the audio flex cable from the lower left corner of the logic board.
3. Disconnect the IPD and Airport/Bluetooth flex cables on the lower right side of the board.

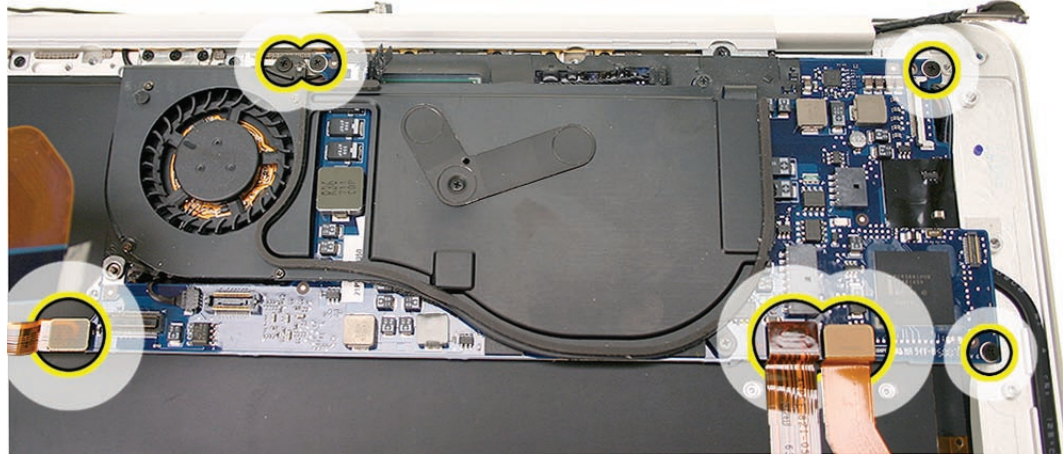

4. Lift and remove the entire module assembly firmly holding the edges of the logic board.
5. **Note:** Take care not to separate the thermal module from the logic board. Otherwise, you must replace the existing thermal paste to ensure proper reinstallation. See thermal module chapter for instructions on how to replace the thermal paste.

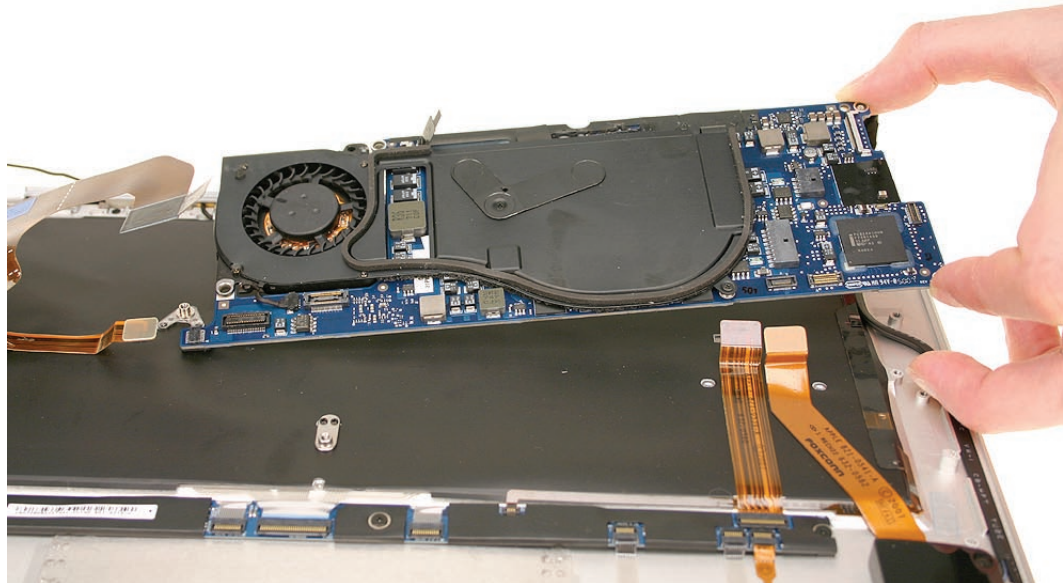

Reassembly Procedure

1. When reinstalling the logic board / thermal module assembly, guide the hole in the lower left corner of the board onto the post in the center of the top case as shown below.

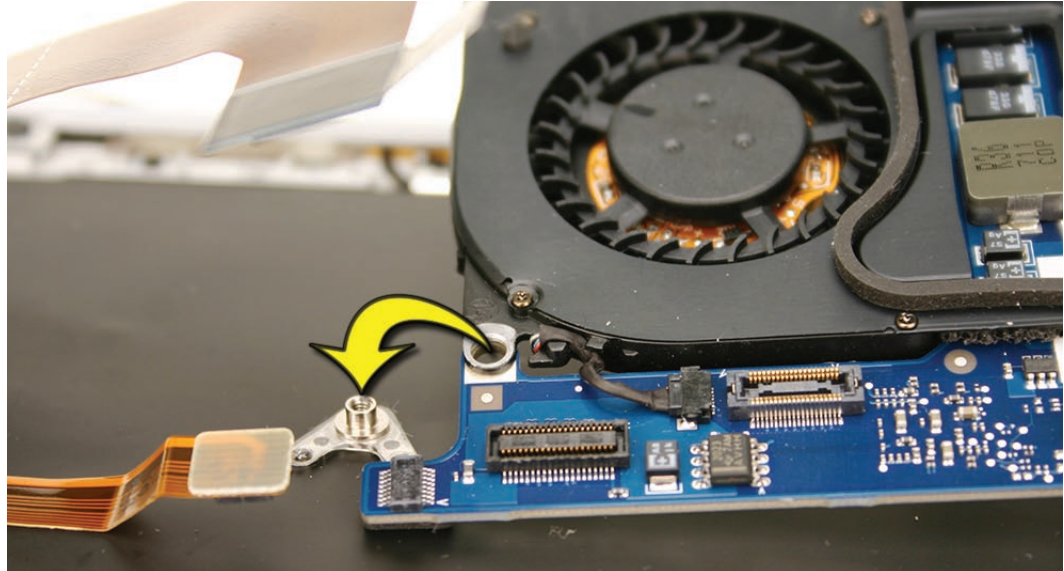

2. Align and seat the board, and reinstall the four screws and three flex connectors below.

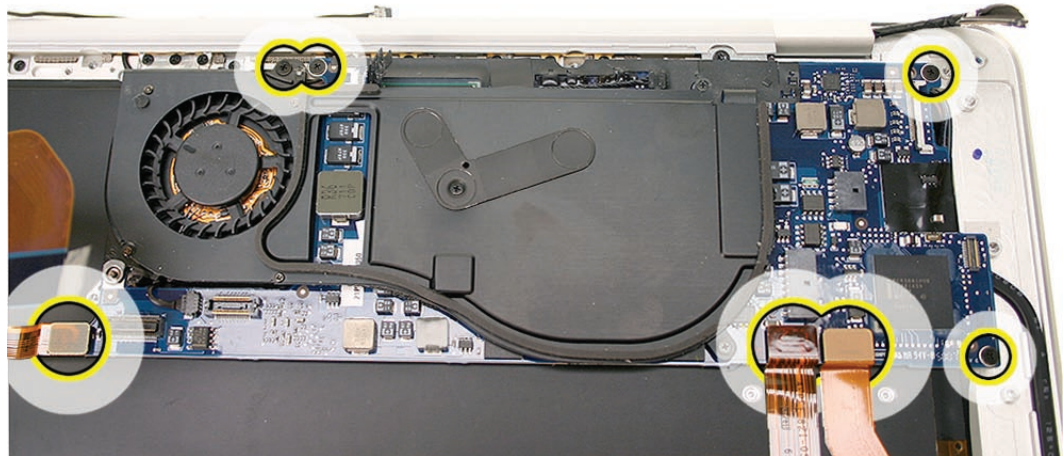

Quick Test

- Check keyboard response, keyboard backlight, trackpad, IR (use Apple Remote) and sleep indicator light to verify correct Input Devices (IPD) flex cable connection.
- Attach power adapter and charge battery to check that the MagSafe connector is properly connected.
- In Apple System Profiler, verify AirPort and Bluetooth presence as well as settings.
- Check all I/O ports on port hatch.



Display Assembly

Tools

This procedure requires the following tools:

- #000 Phillips screwdriver (magnetized)
- Torx 6 screwdriver (magnetized)
- Black stick (nylon probe 922-5065) or other non-conductive nylon or plastic flat-blade tool
- Multi-compartment screw tray (such as a plastic ice cube tray)
- MacBook Air display clamshell fixture for service providers (part number 922-8538)

Preliminary Steps

Before you begin, remove the following:

- Bottom case
- Battery
- Speaker assembly
- Port hatch assembly
- Hard drive assembly
- Thermal module and logic board
- Airport/Bluetooth card bracket and antenna connectors

Part Location



Removal Procedure

1. Open the MacBook Air to a 90° angle and insert into the display clamshell fixture, making sure that it is well seated and secure.



2. Carefully lift the Airport/Bluetooth antenna cable from the top case, pulling up slowly from the display side to the Airport/Bluetooth card side to preserve the adhesive.

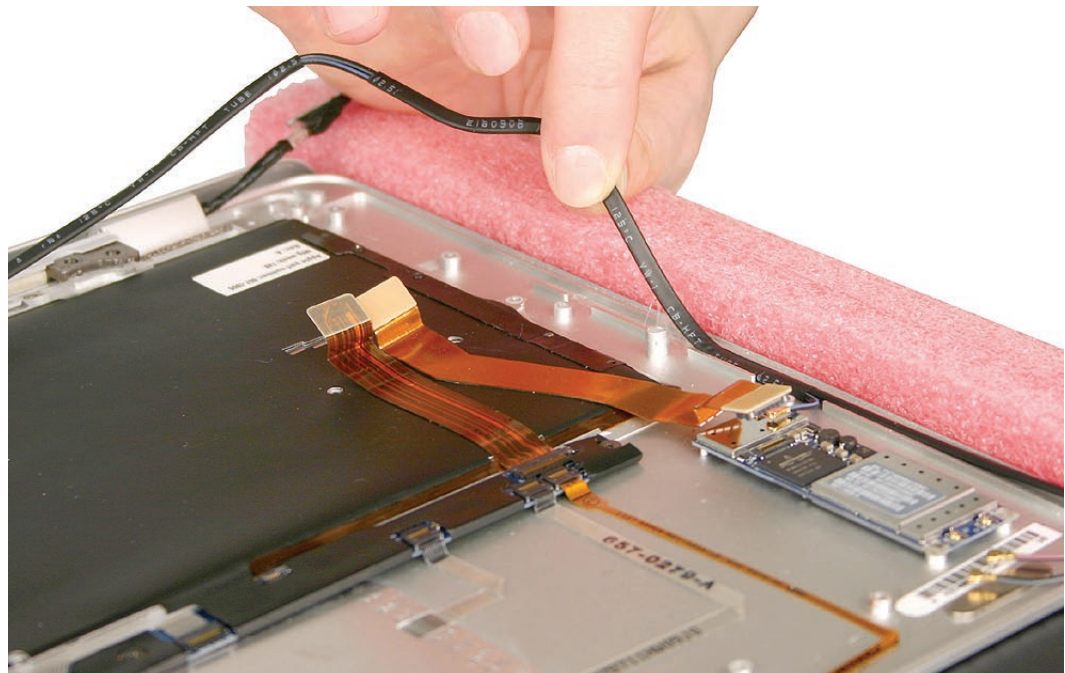

3. Remove 13 identical Phillips screws and then four identical Torx T6 clutch screws.

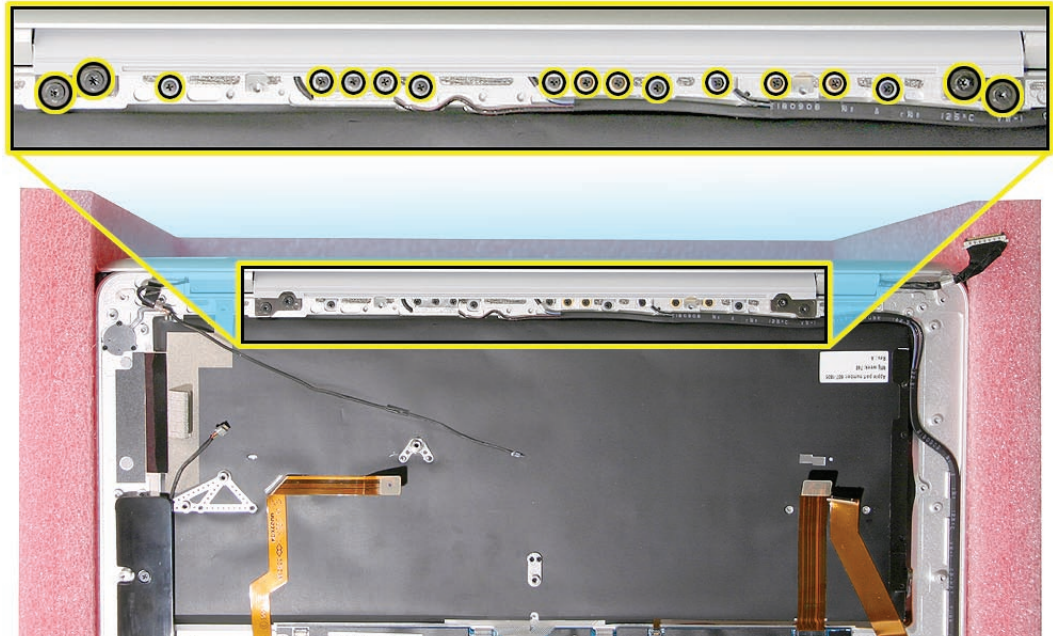

4. Slide the display clamshell up and out of the fixture.

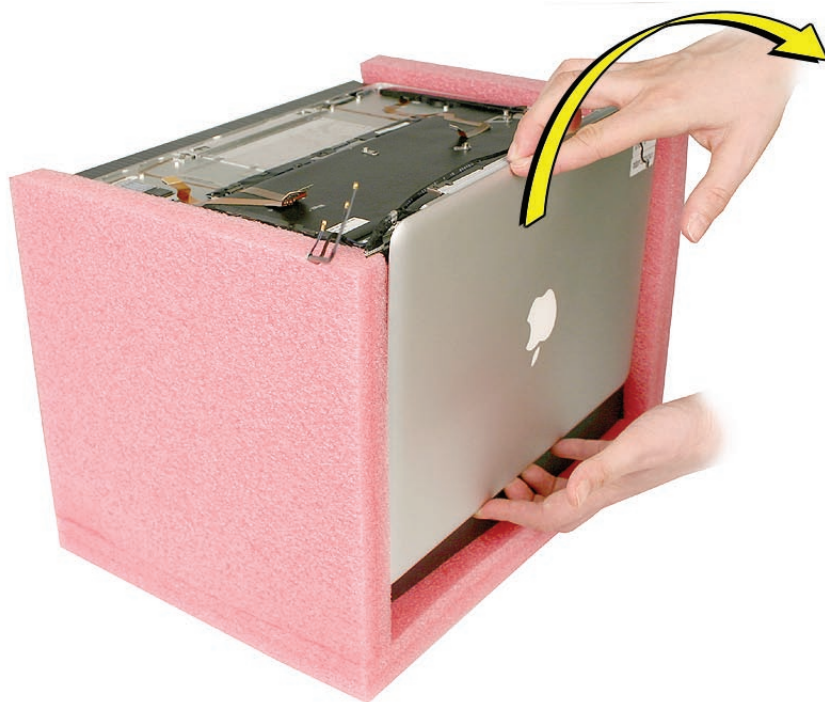

Reassembly Procedure

1. Slide the display clamshell into the fixture, and place the hinge onto the top case, aligning the screw holes.



2. If necessary, slide the antenna assembly a millimeter or two to the left or right to fully align the holes.



3. Install four identical Torx T6 clutch screws first, and then install the remaining 13 identical Phillips screws.

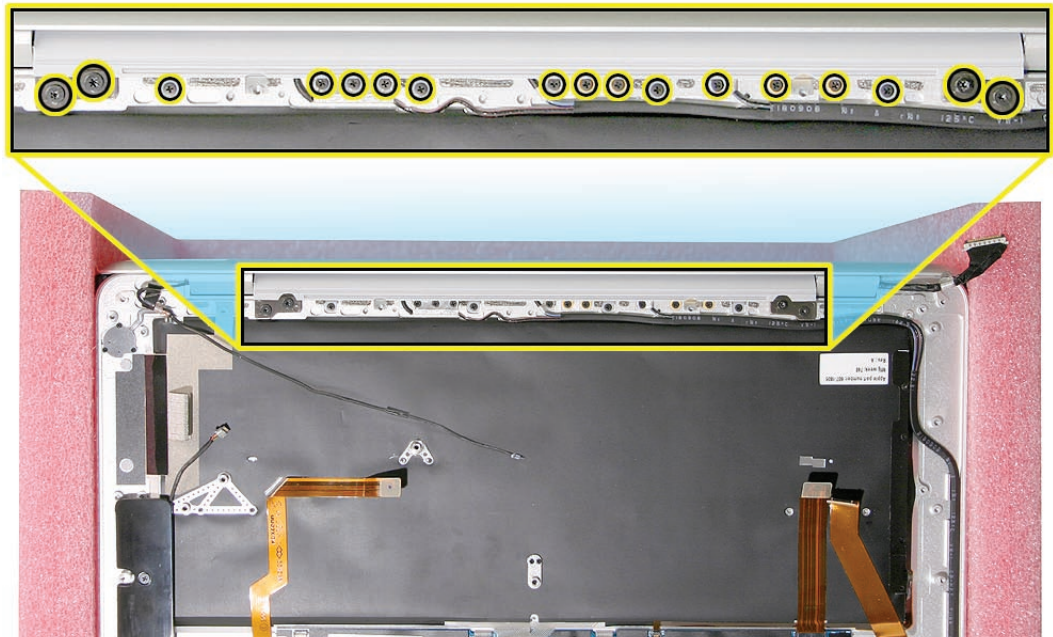

4. Remove the MacBook Air from its fixture and check for proper alignment.

Quick Test

1. Check the display brightness, the microphone, the iSight camera, and the ambient light sensor to verify proper display cabling
2. Check AirPort antenna functionality by browsing to a known-good web site
3. Check Bluetooth antenna functionality by attempting to transfer a file to another Mac



Audio Flex Cable

Tools

This procedure requires the following tools:

- Standard #2 graphite pencil
- Ruler or straight edge

Preliminary Steps

Before you begin, remove the following:

- Bottom case
- Battery
- Speaker assembly
- Hard drive assembly

Part Location

Note: Although this image shows the logic board and some other components removed, only the parts listed above require removal for this procedure.

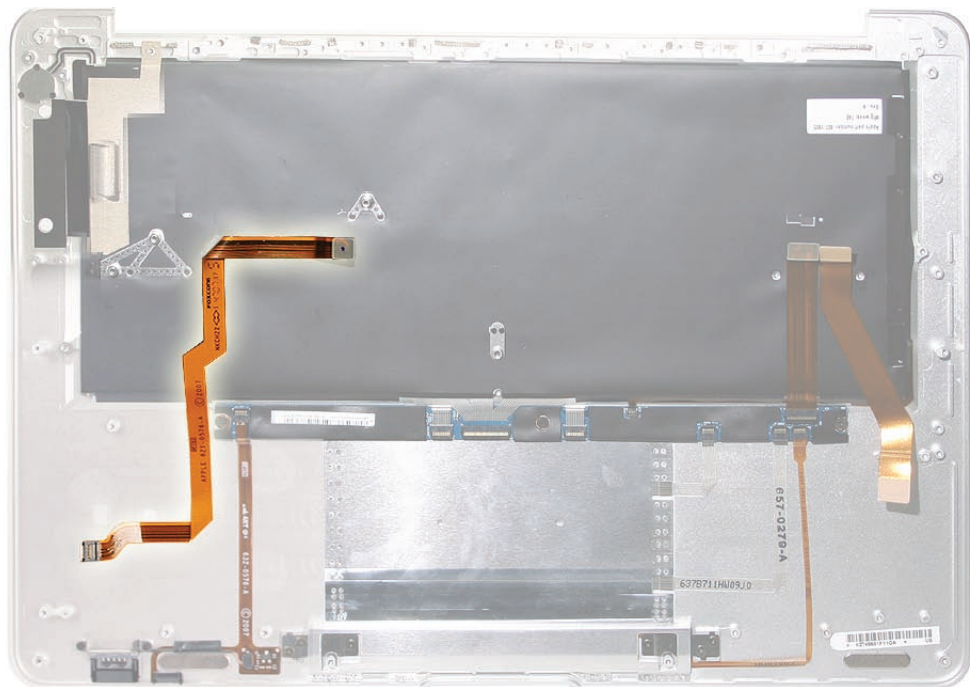

Procedure

1. Note the positioning of the audio flex cable on the top case. From the orientation shown below, the upper right connector attaches to the logic board, and the lower left connector attaches to the audio board inside the speaker assembly.

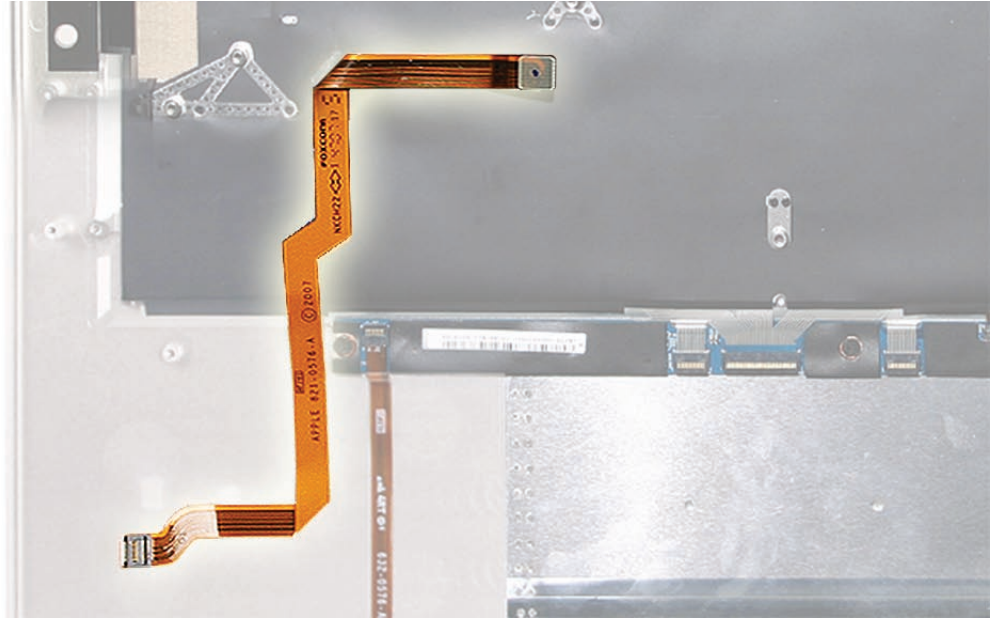

2. Use a #2 graphite pencil to lightly, but visibly, trace the edge of the lower bend of the cable onto the top case, precisely from fold to fold.



3. As in the above step, use the pencil to very lightly trace the upper bend in the cable onto the black mylar, precisely from fold to fold, being careful of the keyboard assembly beneath.

Note: If transferring the cable to a completely new top case, start with the connection to the logic board first, then extend from there to attach the cable to the top case.

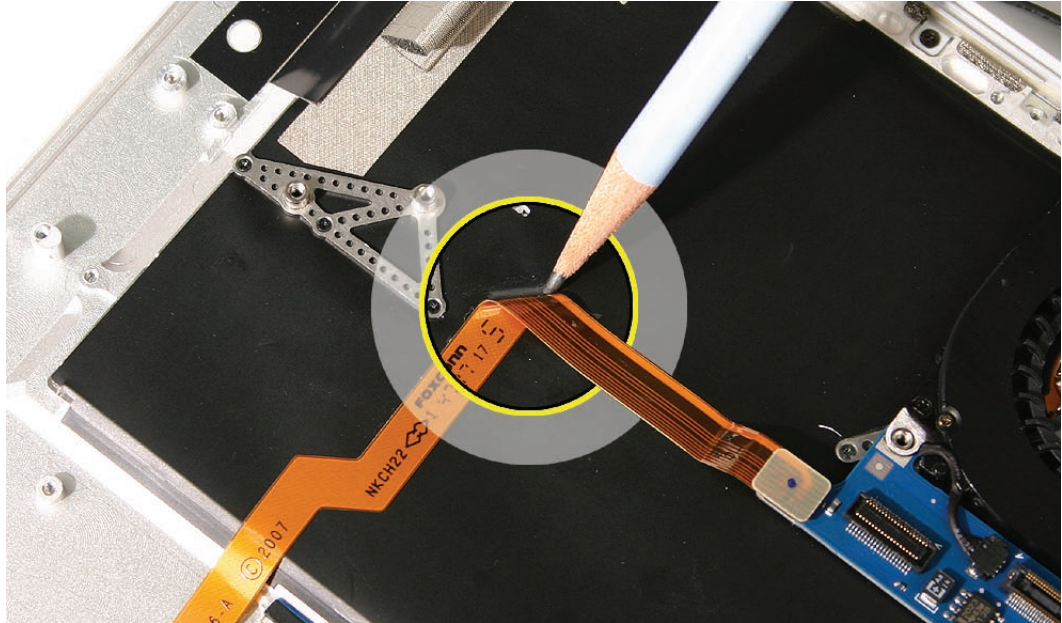

4. When installing the cable, align it as shown below, using two corners of the triangular screw post bracket on the top case as a guide (given that the logic board is installed as above).

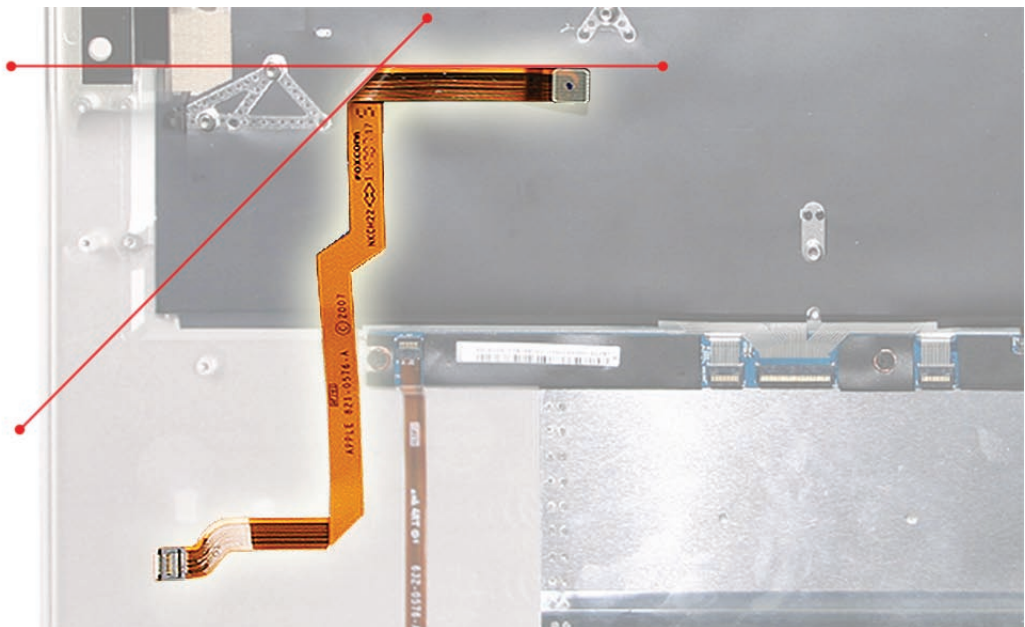

5. Slowly peel the flex cable away from the top case from each end, keeping your fingers within two inches of the point of removal to avoid twisting or stretching the cable. When reinstalling and/or transferring the flex cable, keep the adhesive on the cable intact for reuse.

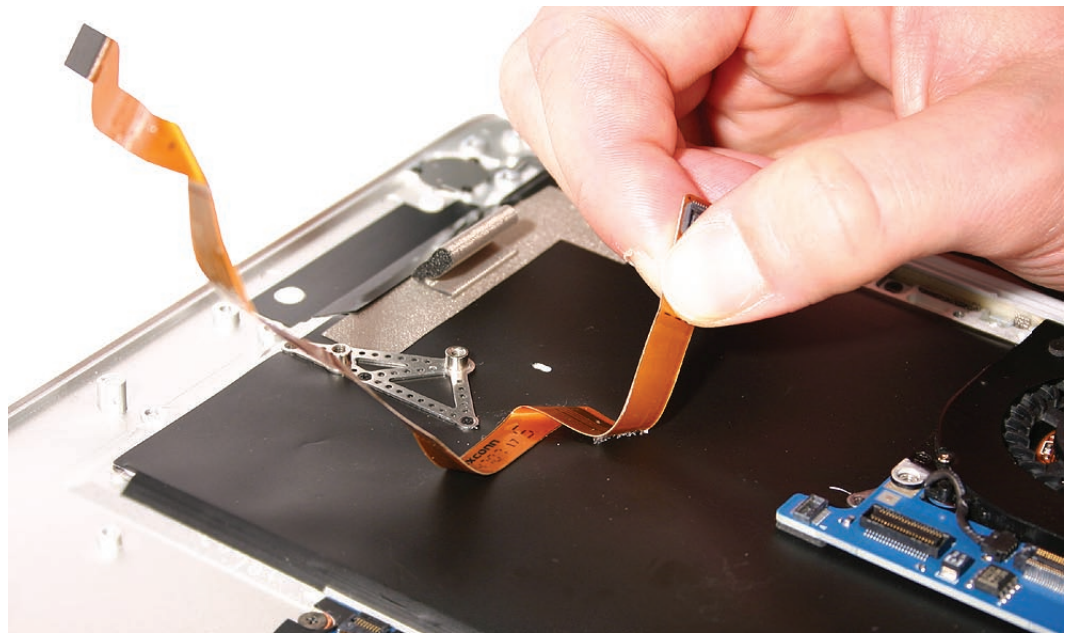
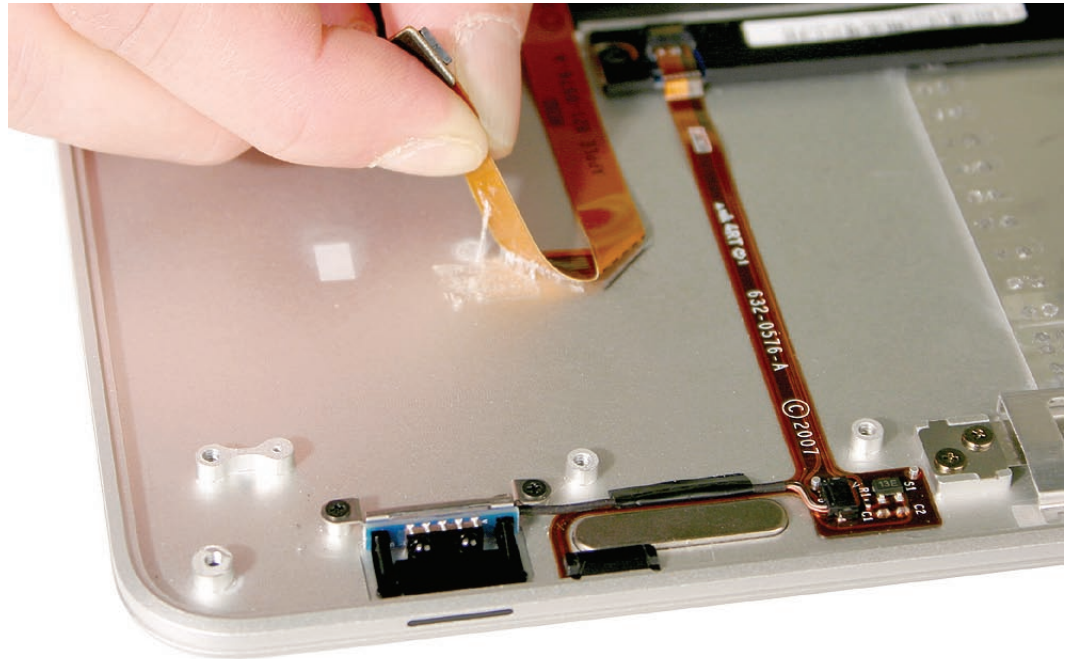

Quick Test

1. Check for clear and audible sound output from the speaker.
2. Plug headphones or speakers into the analog audio jack and check for output.



Input Devices (IPD) Board Flex Cable

Tools

This procedure requires the following tools:

- Black stick (nylon probe 922-5065) or other non-conductive nylon or plastic flat-blade tool

Preliminary Steps

Before you begin, remove the following:

- Bottom case
- Battery
- Flex cable bracket to the logic board
- Airport/Bluetooth card bracket and antenna connectors

Part Location

Note: Although this image shows the logic board and some other components removed, only the parts listed above require removal for this procedure.

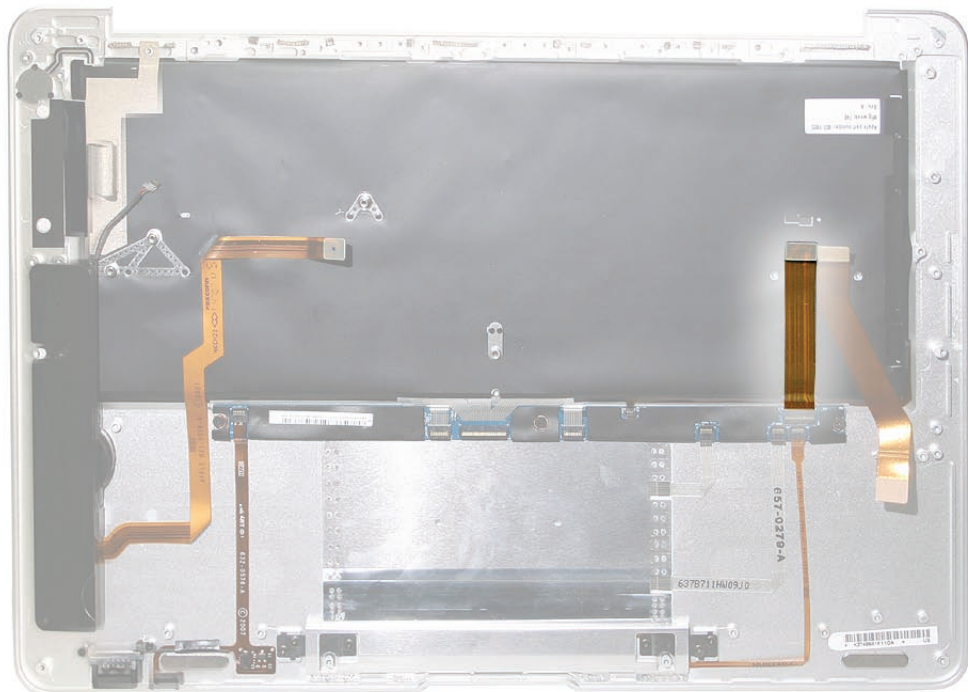

Procedure

1. Note the flex cable's connection from the logic board to the InPut Devices board (IPD) located in the center of the top case below the keyboard.

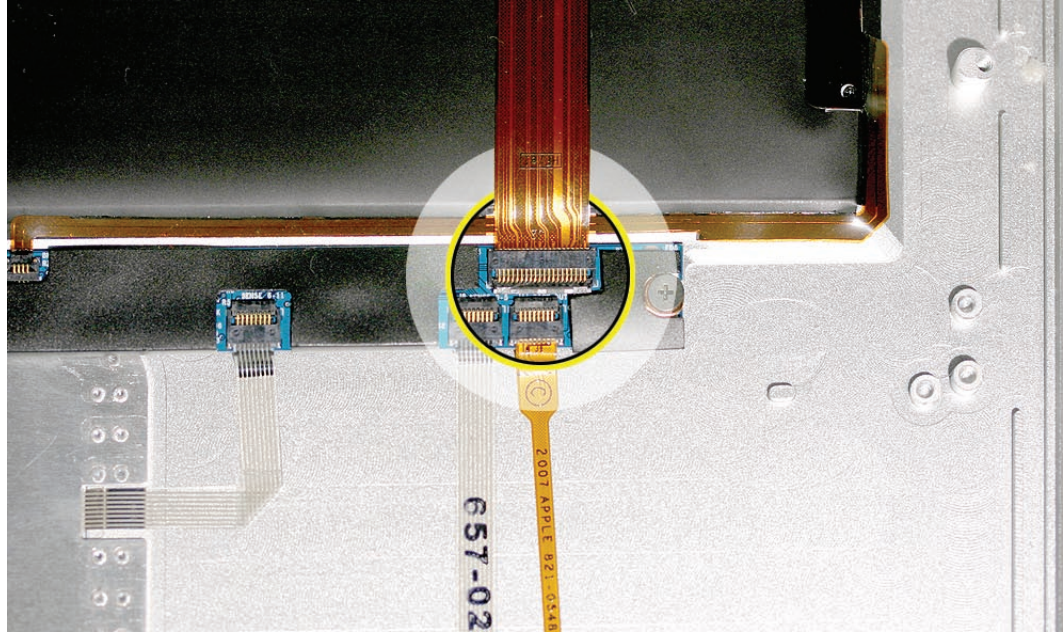

2. With the flat end of a new sharp black stick or other small non-conductive probe tool, gently and carefully flip up the small, black connector lever 90° toward the cable.

Note: Use great care and finesse—this connector is very delicate.

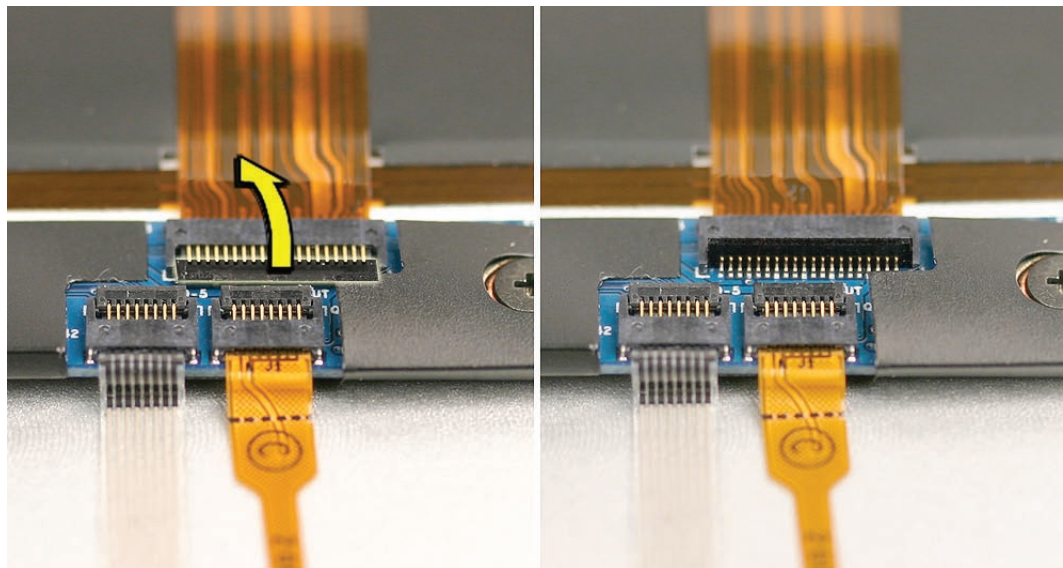

3. Starting at the end toward the logic board, gently peel up the cable from the mylar on the top case, preserving the adhesive for transfer, if applicable.
4. Slide the cable horizontally from the ZIF connector, parallel to the top case.

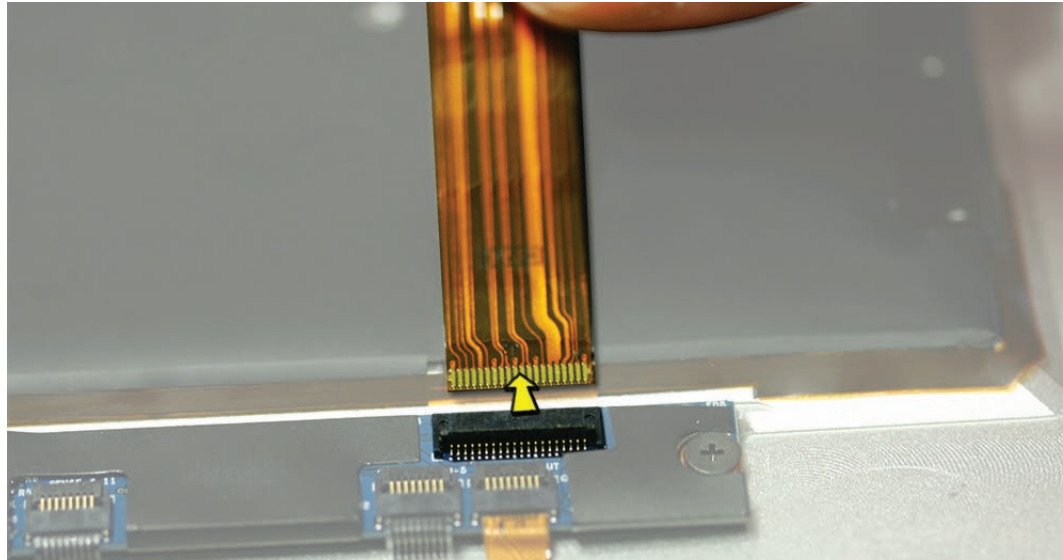

Replacement Notes

1. When installing or reinstalling the IPD board cable, insert the cable end horizontally into the ZIF connector on the IPD board. Before securing the ZIF lever, however, connect the other end of the cable to the logic board and smooth the cable between the two connectors, adhering it to the mylar on the top case.
2. Once the cable sits flat and evenly between the logic board and IPD board, and the connector on the IPD board is fully seated, close the ZIF lever using a black stick to swing it downward into its locked position.

Quick Test

1. Check trackpad, trackpad button, and keyboard for full functionality.
2. Check to see that the sleep indicator light indicator pulses when the top case is closed.
3. Test infrared reception.



Airport/Bluetooth Card Flex Cable

Tools

This procedure requires the following tools:

- Standard #2 graphite pencil

Preliminary Steps

Before you begin, remove the following:

- Bottom case
- Battery
- Flex cable bracket to the logic board
- Airport/Bluetooth card bracket and antenna connectors

Part Location

Note: Although this image shows the logic board and some other components removed, only the parts listed above require removal for this procedure.

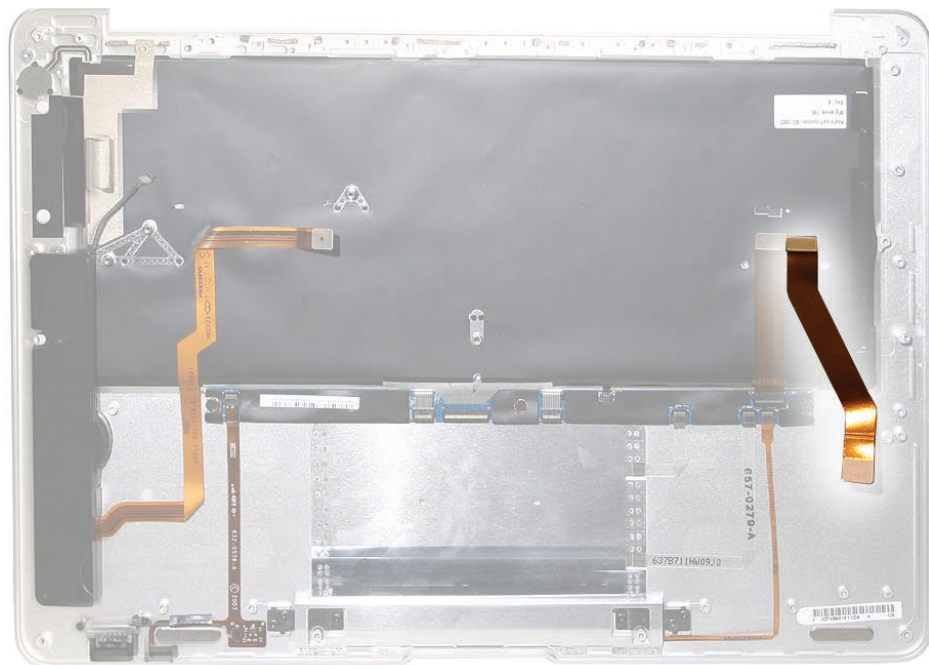

Procedure

1. Note the position of the Airport/Bluetooth Card flex cable on the top case in relation to the IPD board flex cable to its left.

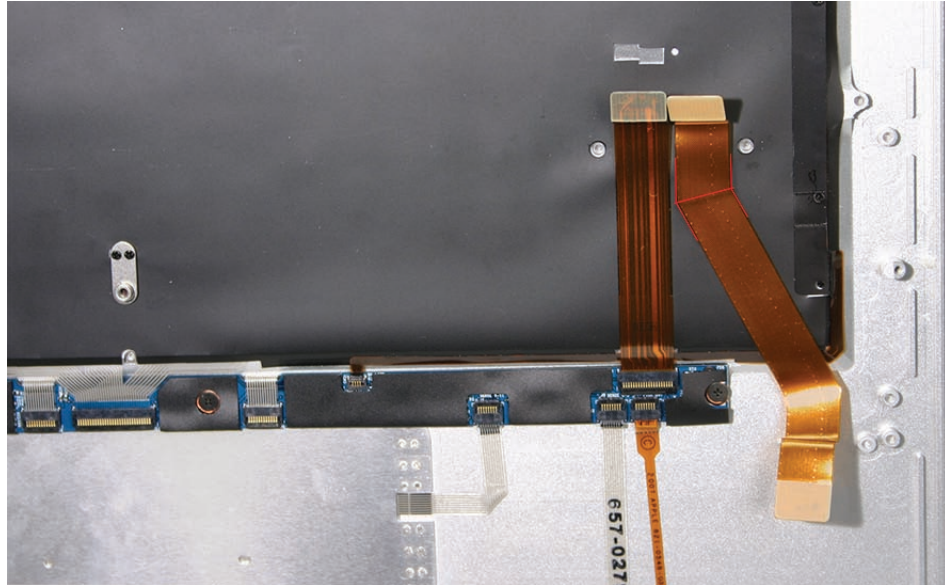

2. Use a #2 pencil to mark the outer and inner sides of the corner angle where the cable bends 30° away from the logic board connector. Mark lightly and gently on the top case only (not on the cable), being mindful of the keyboard assembly underneath.

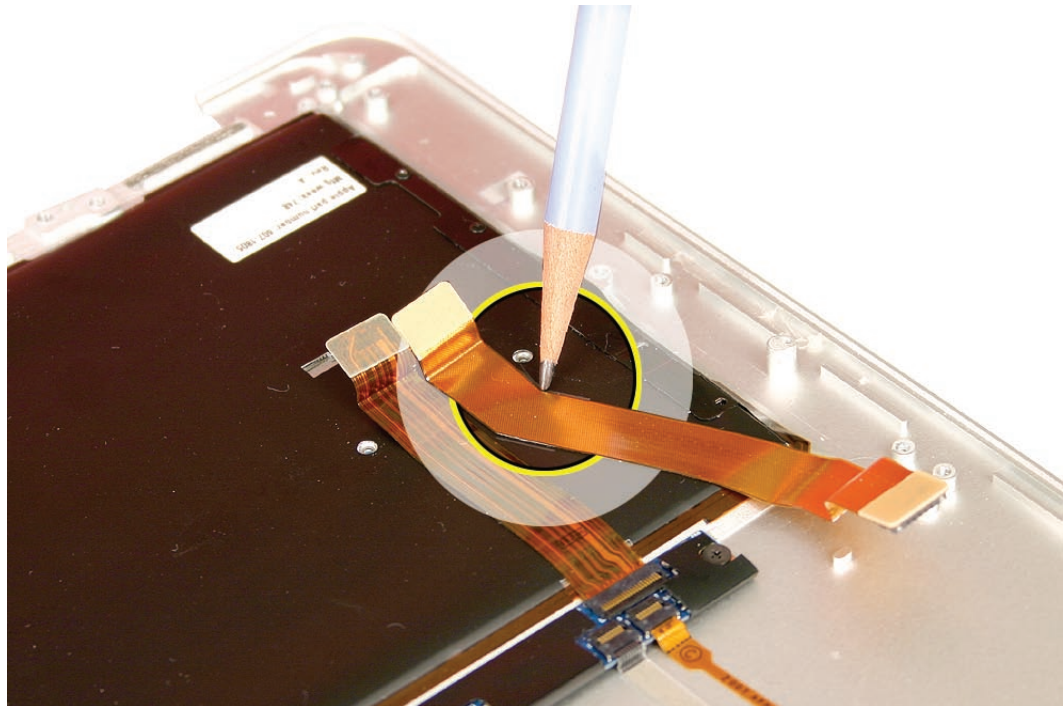

3. Gently peel up the flex cable taking care to preserve the adhesive for reuse, if applicable.

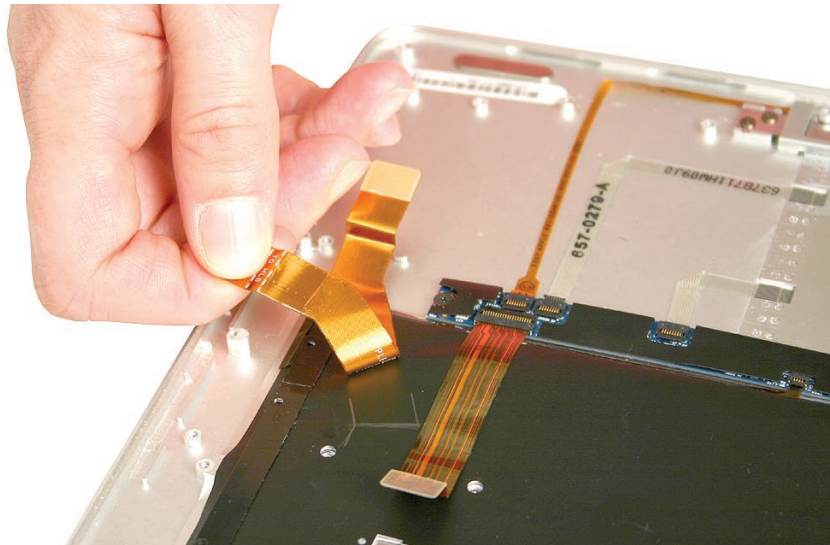

Replacement Note

Note: When reinstalling or installing a new Airport/Bluetooth Card flex cable to the same top case, use the pencil markings as a guide. However, to ultimately confirm placement, seat the connectors onto the logic board and Airport/Bluetooth Card, and check that the cable lies smooth and flat between the connectors, with no bubbles, ripples, or stressed edges.

Note: When transferring the Airport/Bluetooth Card cable to a new top case, confirm placement by first seating the logic board connector, extending the cable exactly parallel to the IPD flex cable (and edge of the top case), then seat the Airport/Bluetooth Card connector. Check that the cable extends smoothly between the connectors, with no bubbles, ripples, or stressed edges.

Quick Test

1. In Apple System Profiler, verify AirPort and Bluetooth presence as well as settings.
2. Check AirPort functionality by browsing to a known-good web site.
3. Check Bluetooth functionality by attempting to transfer a file to another Mac.



Top Case with Keyboard

Tools

This procedure requires the following tools:

- Black stick (nylon probe 922-5065) or other non-conductive nylon or plastic flat-blade tool
- Multi-compartment screw tray (such as a plastic ice cube tray)

Preliminary Steps

Before you begin, remove the following:

- Bottom case
- Battery
- Speaker assembly
- I/O hatch assembly
- Hard drive assembly
- Thermal module and logic board
- Combo card (Airport/Bluetooth) bracket and antenna connectors
- Display clamshell assembly
- Three flex cables: audio, IPD and combo card

Part Location

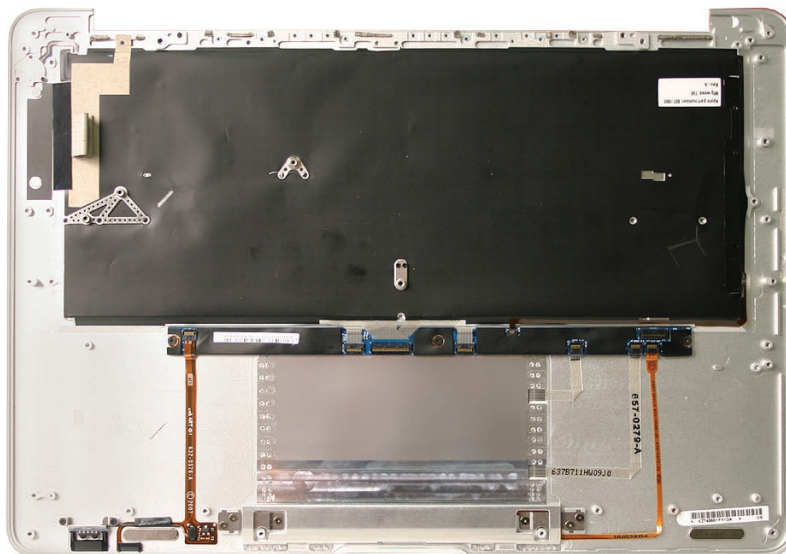

Anatomy of the top case

After all the components listed on the previous page have been removed from the system, only the top case with its integrated keyboard remains. However, note that the top case still contains other subparts and assemblies. These parts and their function are outlined below.

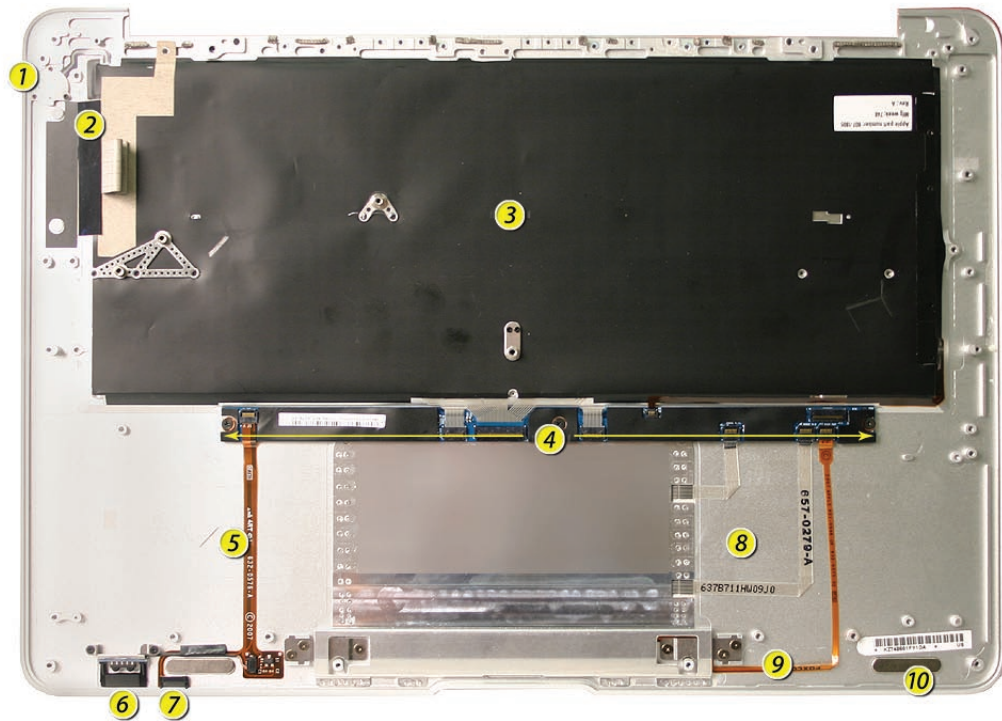

- | | |
|---|---|
| ❶ power button | ❹ IR receiver |
| ❷ port hatch EMI shields and gaskets | ❺ sleep light indicator |
| ❸ keyboard (multi-layered, 42 screws) | ❻ multi-touch trackpad cables to IPD board |
| ❹ IPD (InPut Devices) board | ❼ trackpad button cable to IPD board |
| ❺ IR / sleep sensor flex cable to IPD board | ❽ top case magnet (right; see same on left) |

Note: The IPD board provides the trackpad control logic, which is calibrated to each top case. Because those calibration values are stored on the IPD board, the top case and IPD board are a matched set. Do not disconnect any flex cables from the IPD board other than the main IPD cable to the logic board. All other flex cables connect to parts that are not replaceable.

Quick Test

1. Check keyboard function, including backlight.
2. Check trackpad and button functions, including multi-touch capabilities.
3. Check sleep indicator light functionality.

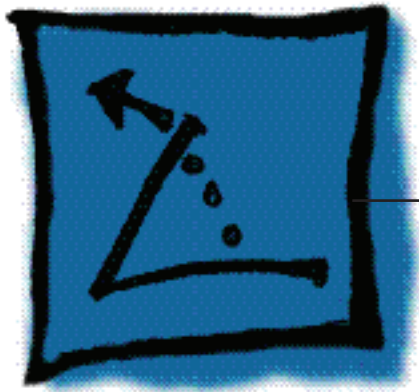

Additional Procedures

MacBook Air

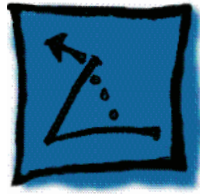

Replacing Keycaps

Tools

- ESD wrist strap and mat
- Black stick (Apple part no. 922-5065) or other nonconductive nylon or plastic flatblade tool
- Fine-point tweezers
- Needlenose pliers

Preliminary Steps

Note: Though much of the photography in this section shows the keyboard of a MacBook rather than MacBook Air, the procedures are exactly the same.

Part Location

The Darfon keyboard comes in three versions: ANSI, ISO, and JIS. Refer to the following keyboard layouts to help identify them.

ANSI Keyboard Layout:



ISO Keyboard Layout:



JIS Keyboard Layout:



Procedure

The keycaps are secured to the top case keyboard with a scissor mechanism. This mechanism operates the same for all keys although its design differs depending on the shape of the key. For instance, square keys (i.e., letters A–Z, numbers, punctuation) employ an identical scissor mechanism, whereas larger, rectangular keys (i.e., Shift, Delete, Return, Space bar) use slightly different scissor mechanisms and employ one or two metal stabilizer bars.

Removing and Replacing a Square Key

1. If a key needs to be removed (for example, if a key is sticking when pressed), always pry it up from the left side—either the upper or lower left corner.



2. Because adhesive is used under the top case, closely inspect the case for any adhesive that may have built up under the keycap. Lift away any built-up adhesive using a black stick or fine-point tweezers.

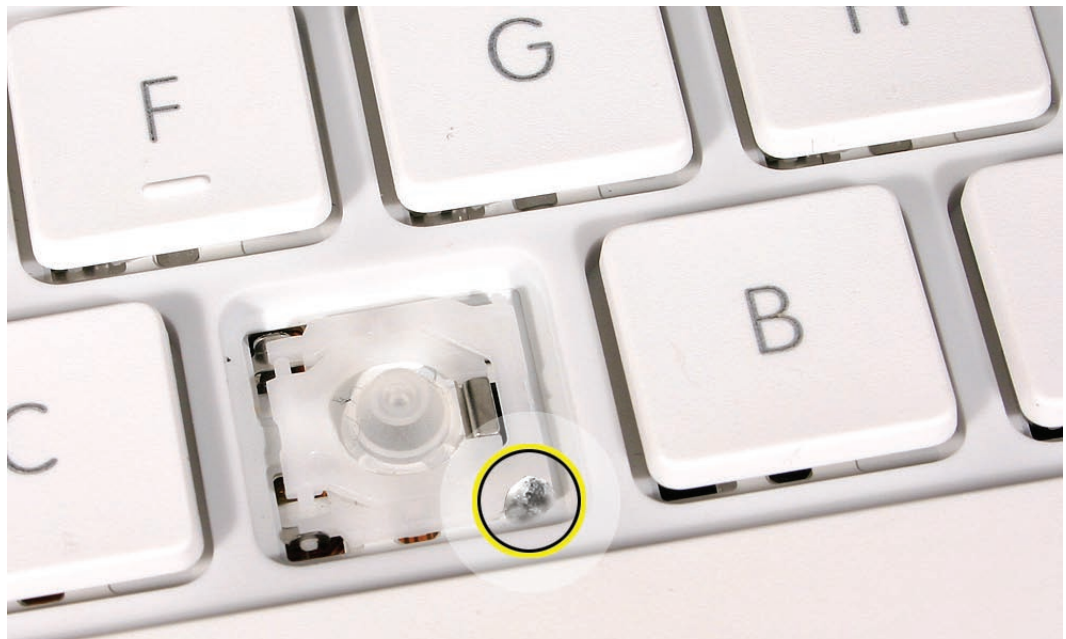

3. Test the operation of the scissor mechanism by using a black stick to carefully raise and lower the mechanism.



- If it is installed correctly, the scissor should move smoothly.
- If it is loose, remove it and compare the two parts of the scissor mechanism to the image below.
 - The inner piece should pivot smoothly within the outer piece.
 - When closed, its profile should be fully flat.
 - The slider bar and all four pins should be intact.

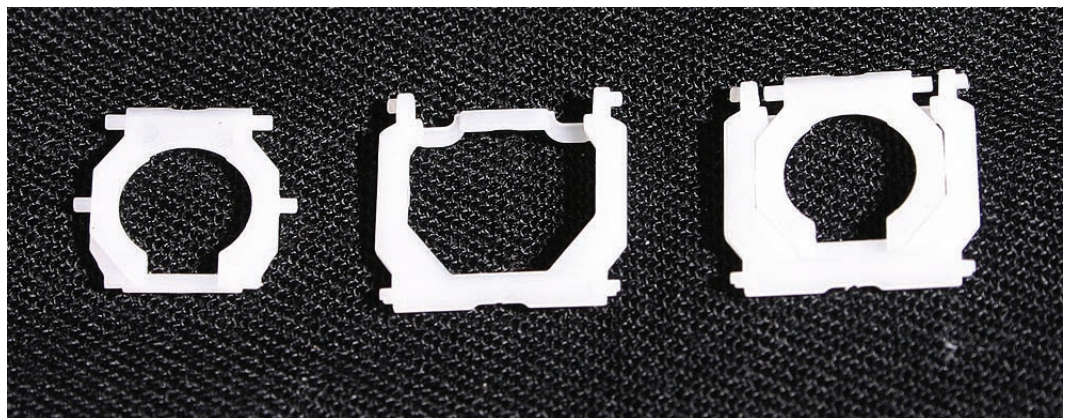

4. Check the underside of the keycap for two clips on one side and two hooks on the other side.

- If any of the hooks or clips are bent, broken, or missing, replace the keycap.
- If the hooks and clips are intact, re-use the keycap.

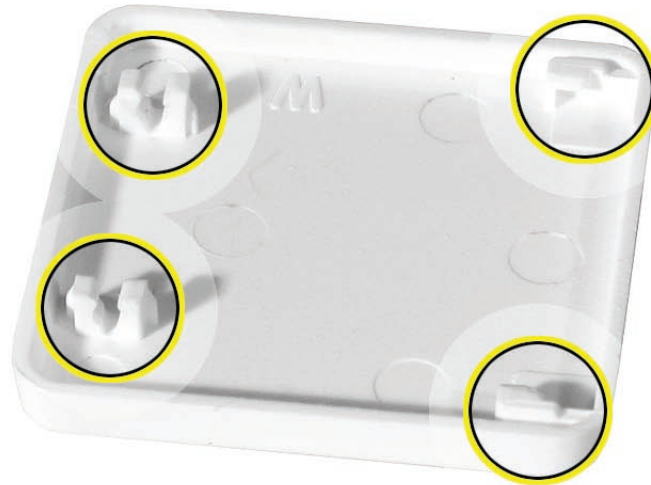

5. Check the rubber dome and raised metal areas inside the keycap opening on the top case.

- When the rubber dome is pressed and released, it should spring back upright. If the rubber dome is off center or damaged, replace the top case.
- If the metal hook that holds the slider bar of the scissor mechanism is bent, try to bend it back to a uniform 90-degree angle. If it is bent or broken beyond repair, replace the top case.
- If the two metal ears are bent, use needlenose pliers to straighten them. If either or both are broken beyond repair, replace the top case.

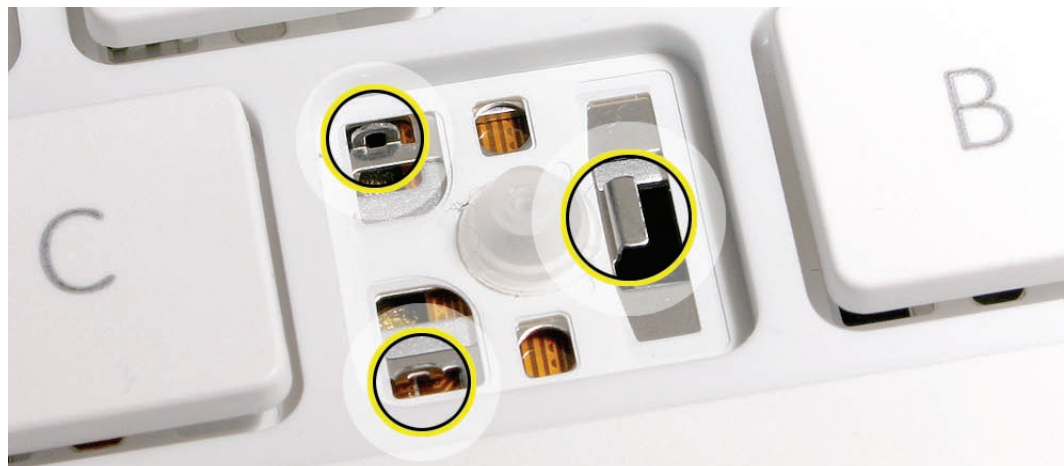

6. With the scissor mechanism open, install the slider bar under the metal hook of the top case.



7. Allow the scissor mechanism to fold flat and hold the slider bar in place while using a black stick to insert the scissor pins—one at a time—into the top case ears.



8. With the scissor pins inserted, use a black stick to raise and lower the scissor mechanism to make sure it moves freely.



9. Moving from left to right, slide the right end of the keycap into the keycap well so that the hooks inside the right side of the keycap latch onto the pins on the right side of the scissor mechanism.

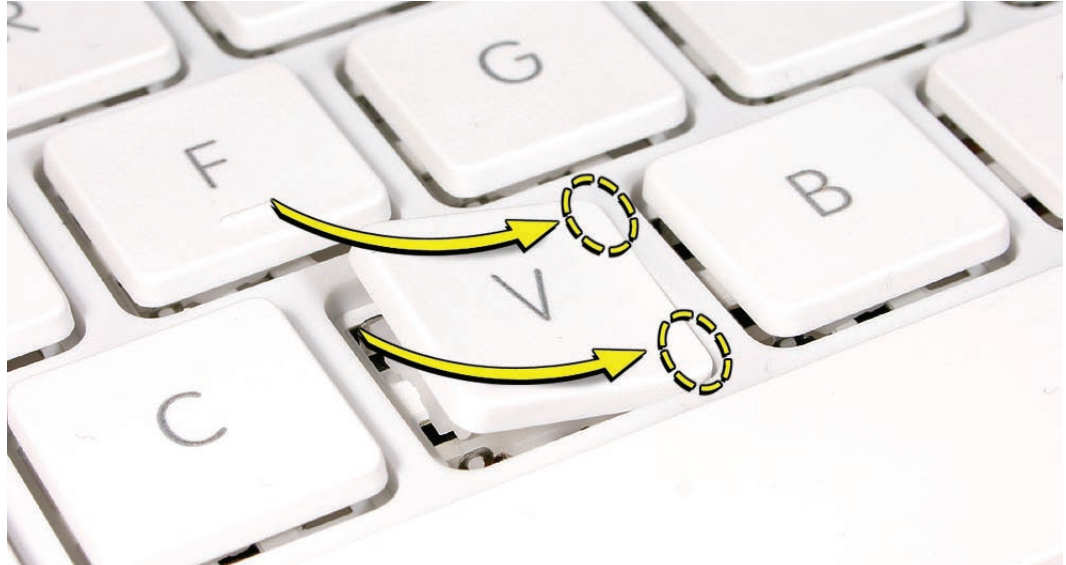

10. Press down on the left side of the key until the keycap snaps into place.



11. Check the key from all angles to make sure it is uniformly flat. Press and release the key repeatedly to verify that it springs back each time.

Reassembling the Scissor Mechanism

If the two pieces of a scissor mechanism come apart,

- Check that the pieces are not damaged. The image below shows the separate scissor pieces and the fully assembled scissor mechanism.
- Flex the outer piece to install the pins of the inner piece in the slots. The intact scissor mechanism should swivel smoothly and fold flat.

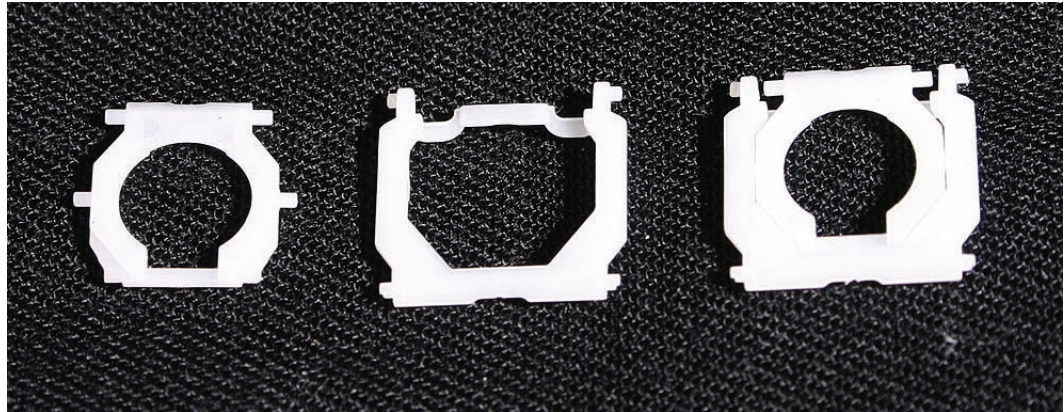

Removing and Replacing the Space Bar

1. If a rectangular-shaped key needs to be removed (for example, if a key is sticking when pressed), always pry it up from the left side—either the upper or lower left corner.



2. Because adhesive is used under the top case, closely inspect the case for any adhesive that may have built up under the keycap. Lift away any built-up adhesive using fine-point tweezers.

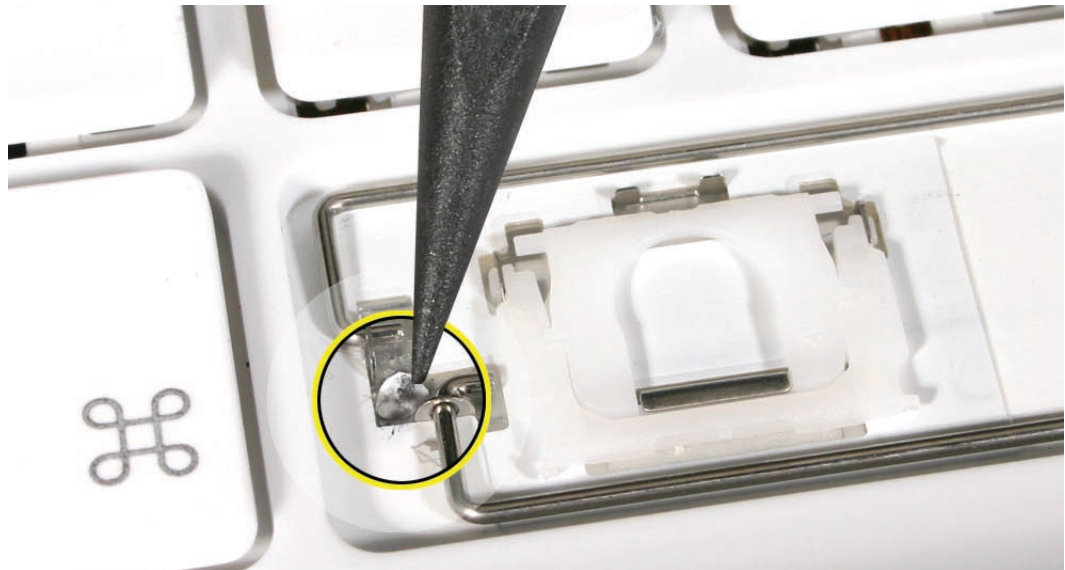

3. Test the operation of the scissor mechanism by using a black stick to carefully raise and lower the mechanism.



- If it is installed correctly, the scissor should move smoothly.
- If it is loose, remove it and compare the two parts of the scissor mechanism to the image below.
- The inner piece should pivot smoothly within the outer piece.

-
- When closed, its profile should be fully flat.
 - The slider bar and all four pins should be intact.

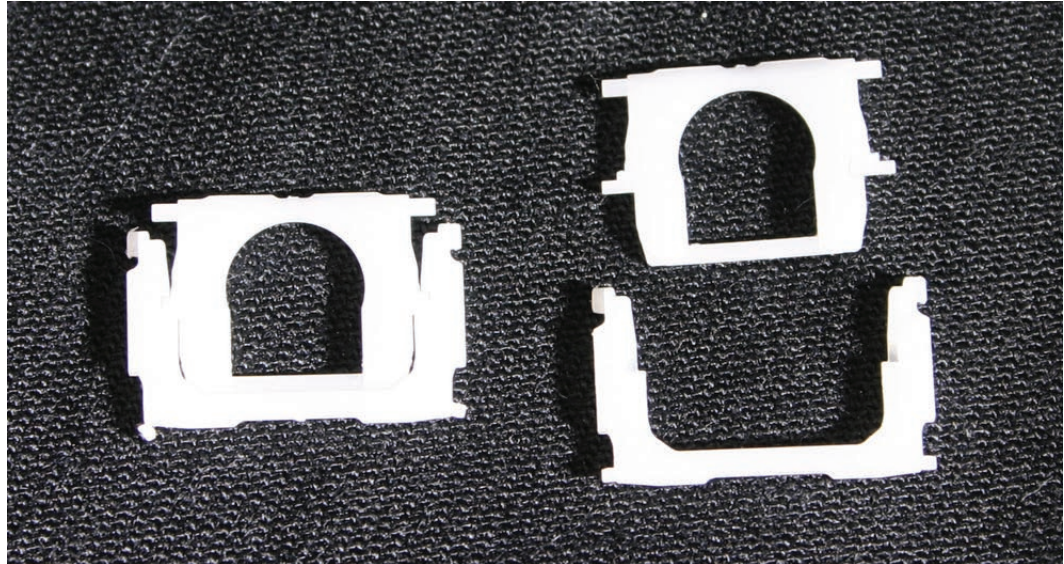

4. Inspect the rows of clips on the underside of the keycap.
 - If any of the clips are bent, broken, or missing, replace the keycap.
 - If the clips are intact, re-use the keycap.

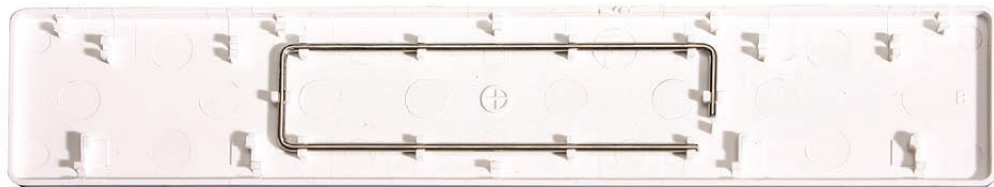

5. Check the rubber dome and raised metal areas inside the keycap opening on the top case.

- When the rubber dome is pressed and released, it should spring back upright. If the rubber dome is off center or damaged, replace the top case.

- If the metal hook that holds the slider bar of the scissor mechanism is bent, try to bend it back to a uniform 90-degree angle. If it is bent or broken beyond repair, replace the top case.

- If the two metal ears are bent, use needlenose pliers to straighten them. If either or both are broken beyond repair, replace the top case.

- If a metal stabilizer bar is bent, try to straighten it.



6. With the scissor mechanism open, install the slider bar under the metal hook of the top case.

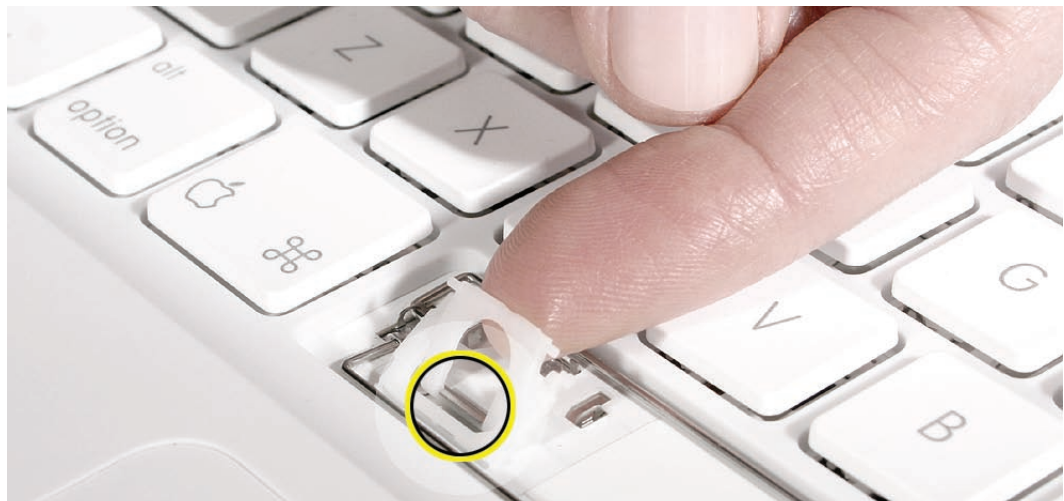

7. Allow the scissor mechanism to fold flat and hold the slider bar in place while using a black stick to insert the scissor pins—one at a time—into the top case ears.

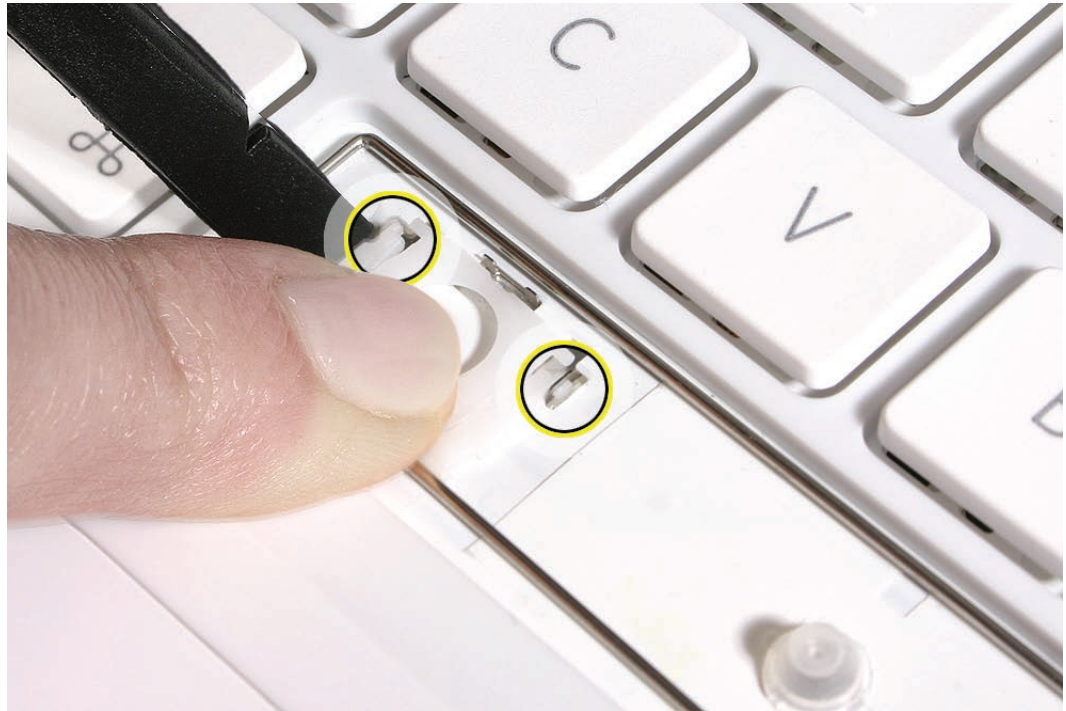

8. With the scissor pins inserted, use a black stick to raise and lower the scissor mechanism to make sure it moves freely.



9. Check the keycap well area on the top case. If the bottom stabilizer bar is pushed up, move it down as far as it will go.

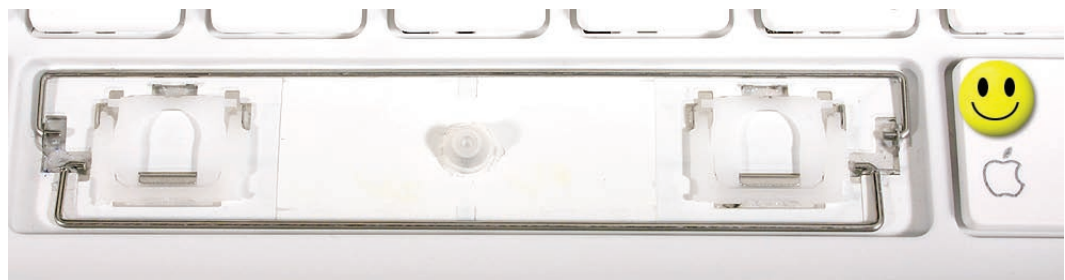

10. Determine which is the top of the Space bar keycap by checking the clips on the inner plane. The top of the keycap has the row of clips that extend closest to the sides of the keycap. These top clips most closely match the longest stabilizer bar at the top of the keycap well.

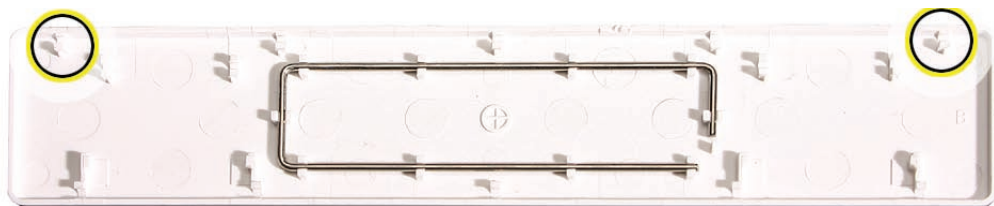

11. Align the bottom row of clips inside the bottom edge of the keycap with the bottom stabilizer bar.

12. Press and slide your finger along the **bottom** of the Space bar over the bottom stabilizer bar until you hear the clips click into place. (The keycap is tilted up at this stage.)



13. Press along the top of the Space bar to secure it to the top stabilizer bar. (Listen for the keycap clicking into place.)



14. Press the length of the Space bar to ensure all clips are secure.



15. Check the key from all angles to make sure it is uniformly flat. Press and release one corner of the key. If the key is installed correctly, the opposite corner should respond at the same level (not tilted higher or lower).





Troubleshooting
MacBook Air



General Information

How to Use the Symptom Charts

The Symptom Charts included in this chapter help diagnose specific symptoms related to the MacBook Air. A section is dedicated to normal startup, with sections to identify and troubleshoot [No Power, No Video](#) and [Power, but No Video](#) symptoms.

The steps to solve a symptom are listed sequentially. You might not need to perform every step before the symptom is resolved. Start with the first step, and then test for the symptom. If the symptom persists, replace any modules you removed, go to the next step, and test again. Continue down the list until the symptom is resolved.

Wire and Flex Cables

Because of the MacBook Air's extremely thin enclosure design, precise cable handling and placement is crucial.

Below is a list of cables and the signal(s) that each cable carries. If you notice a combination of functions failing simultaneously, an improperly inserted or damaged cable may be the culprit. Many of the cables listed below can be replaced as separate parts, including the Input Devices (IPD) board to logic board cable; however, all other cables to and from the IPD board (other than the IPD to logic board cable) are part of the top case and therefore should not be disconnected.

Cable or Flex Cable	Signal(s) Running Through It
Hard drive flex cable	Hard drive data and power
Input Devices (IPD) board flex cable (leading to the logic board)	Infrared data and power (to logic board) Sleep indicator power Sleep sensor Trackpad data and power Trackpad button Keyboard data and power Keyboard backlight power
Trackpad flex cable	Trackpad data and power (to IPD board)
Keyboard flex cable	Keyboard data and power (to IPD board) Power on signal
Infrared / sleep flex cable	Infrared data and power (to IPD board) Sleep indicator light Sleep sensor
Airport/Bluetooth card antenna cable	AirPort/Bluetooth radio signal
Airport/Bluetooth card flex cable	AirPort/Bluetooth digital data & power

Cable or Flex Cable	Signal(s) Running Through It
Fan cable	Power/control for fan
LVDS cable	Display video data and power Built-in camera video data and power Ambient light sensor data and power
Internal microphone cable	Microphone input
Audio cable from speaker board	Analog audio-out only
Port hatch flex cable	USB 2.0 Analog audio-out DVI video
MagSafe assembly cable	DC power to system

Hardware Diagnostics

AppleCare offers two diagnostics for MacBook Air. Apple Hardware Test (AHT) is shipped with every machine and targeted for end-users to troubleshoot their machine. Apple Service Diagnostics (ASD) is offered to Service Providers for more in-depth troubleshooting.

Both applications are available for download from Knowledge Base article 112125: Service Diagnostics Matrix.

Apple Hardware Test (AHT) 3A131

All Apple Hardware Tests for Macintosh professional portables are numbered sequentially starting with the prefix "3A." This approach provides each AHT release a unique version number and eliminates confusion between the same version across different product lines.

To use Apple Hardware Test on the MacBook Air:

1. Disconnect all external devices from the computer except the power adapter.
2. Restart the computer while holding down the D key.
3. When the Apple Hardware Test chooser screen appears, select the language for your location.
4. Press the **Return** key or click the right arrow button.
5. When the Apple Hardware Test main screen appears (after about 45 seconds), follow the onscreen instructions.
6. If Apple Hardware Test detects an issue, it displays an error code. Make a note of the error code before pursuing support options. If Apple Hardware Test doesn't detect a hardware issue, the issue may be software related.

If the previous method doesn't work on the MacBook Air, you can use a networked computer and Remote Install Mac OS X to run Apple Hardware Test. Be sure to install Remote Install Mac OS X on the networked computer first. See the section called **Reinstalling software using Remote Install Mac OS X** later in this chapter.

To run Apple Hardware Test remotely from a networked computer:

1. Insert the Mac OS X Install Disc 1 into the optical disc drive of the computer you are using with the Remote Disc feature.
2. If the other computer is a Mac, open /Applications/Utilities/Remote Install Mac OS X. On Windows, choose "Remote Install Mac OS X" from the Install Assistant.
3. Read the introduction and hold down the Option key while you click Continue in Remote Install Mac OS X to open Apple Hardware Test.
4. On the MacBook Air, when the Apple Hardware Test chooser screen appears, select the language for your location.
5. Press the Return key or click the right arrow button.
6. When the Apple Hardware Test main screen appears (after about 45 seconds), follow the onscreen instructions.
7. If Apple Hardware Test detects an issue, it displays an error code. Make a note of the error code before pursuing support options. If Apple Hardware Test doesn't detect a hardware issue, the issue may be software related.
8. On the remote computer, click Quit to exit Remote Install Mac OS X. If you see a message saying the MacBook Air will be disconnected, click Quit Anyway.

For general information about Apple Hardware Test, see the Apple Hardware Test Read Me file on the Mac OS X Install Disc 1. You can read it on the networked computer, or on the MacBook Air by using DVD or CD Sharing.

For technical support information on Apple Hardware Test, please see Kbase article 25165: "Apple Hardware Test: Support FAQ" and 58624: "Apple Hardware Test: Technical FAQ."

Apple Service Diagnostic (ASD) 3S119

Like AHT above, Apple Service Diagnostic versions are numbered sequentially starting with the prefix "3S." This approach provides each ASD release a unique version number and eliminates confusion between the same version across different product lines.

About the diagnostic LED

MacBook Air computers have a built-in, diagnostic LED. Observe the power light located on the front of the computer and note the flash patterns.

If the diagnostic LED displays five flashes upon startup, and the pattern repeats after a brief pause, the computer's battery may require service. If the power adapter is present and connected to a working power source, the MacBook Air will continue to start up normally; however, the battery should be diagnosed and replaced if necessary.

This 5-flash LED pattern may also occur when waking the computer from sleep if the power adapter is connected and the battery requires service. This is intended to let you know that the battery requires service but can still accommodate continued operation until it can be replaced.

Important: It is important to note that the “Safe Sleep” function may be unable to recover unsaved data if the MacBook Air’s power is interrupted during operation while in this state.

Note: If you’ve replaced the system battery, it may take up to 10 minutes to verify the repair using the LED diagnostic on POST. After replacement, the battery should be charged for at least 10 minutes. This brief burn-in period is recommended to ensure that the new battery has enough power to operate correctly.

Note: To learn about other Power-On, Self-Test diagnostic beeps and LED patterns, see Kbase articles 58183 and 58442. To learn more about the Intel-based Mac startup sequence and error codes, see Kbase article 303083.

Sharing Discs with Remote Disc

You can enable DVD or CD sharing on a networked Mac or Windows computer using the Remote Disc feature, allowing the MacBook Air to share the discs you insert into the optical disc drive of the other computer. Some discs, such as DVD movies and game discs, may be copy-protected and therefore unusable through Remote Disc.

Remote Disc works over wireless and wired networks using the Apple USB Ethernet Adapter.

Note: Make sure you first install the Remote Disc software on the Mac or Windows computer from which you will be sharing the optical drive.

To enable Remote Disc, if the other computer is a Mac:

1. Make sure the other computer and MacBook Air are on the same wireless or wired network.
2. On the remote computer, choose Apple > System Preferences and then open Sharing.

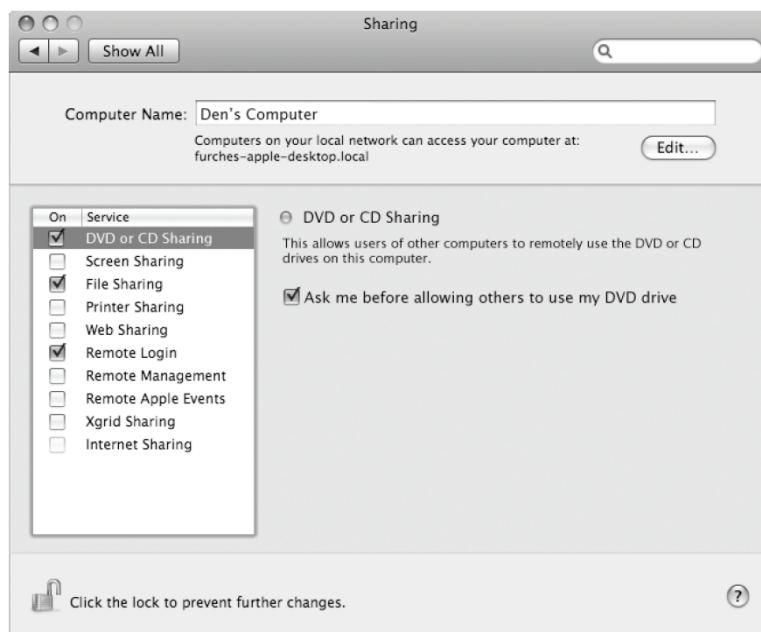

3. In the Sharing panel, select “DVD or CD Sharing” in the Service list. If you want other users to request permission to share a DVD or CD, select “Ask me before allowing others to use my DVD drive.”

To enable Remote Disc, if the other computer is a Windows computer:

1. Make sure the MacBook Air and other computer are on the same wireless or wired network.
2. On the remote computer, open the DVD or CD Sharing control panel.

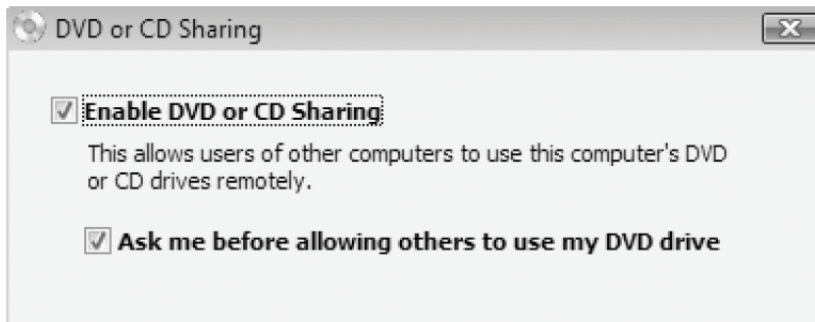

3. Select “Enable DVD or CD Sharing.” If you want other users to request permission to share a DVD or CD, select “Ask me before allowing others to use my DVD drive.”

To use a shared DVD or CD:

1. On the remote computer, insert a DVD or CD into the optical disc drive.
2. On MacBook Air, select the Remote Disc when it appears under Devices in the Finder sidebar. If you see the “Ask to use” button, click it.



3. On the remote computer, when prompted, click Accept to allow the MacBook Air to use the DVD or CD.
4. On the MacBook Air, use the disc as you normally would once it becomes available.

If you try to shut down the remote computer or eject the shared DVD or CD while the MacBook Air is using it, you’ll see a message telling you that the disc is in use. To proceed, click Continue.

Reinstalling software using Remote Install Mac OS X

Use Remote Install Mac OS X on the remote computer whose optical disc drive you want to share when you want to do one of the following tasks on the MacBook Air:

- Reinstall Mac OS X and other software that came with the MacBook Air
- Reset the password
- Use Disk Utility to repair the MacBook Air hard drive

Note: You can also perform these tasks using a MacBook Air SuperDrive. Refer to the next section.

To use Remote Install Mac OS X:

1. Insert the Mac OS X Install Disc 1 into the optical disc drive of the computer you are using with the Remote Disc feature.
2. If the other computer is a Mac, open Applications > Utilities > Remote Install Mac OS X. On Windows, choose "Remote Install Mac OS X" from the Install Assistant.



3. Read the introduction and click Continue.
4. Choose the install disc you want to use, and click Continue.
5. Choose a network connection: AirPort, if you are using an AirPort network, or Ethernet, if the other computer is on an Ethernet network and you have an optional Apple USB Ethernet Adapter connecting the MacBook Air to the same network. Click Continue.
6. Restart the MacBook Air and hold down the Option key as it starts up, until you see a list of available startup disks.
7. Click Continue in Remote Install Mac OS X.
8. If you chose AirPort as the network in step 5, on the MacBook Air choose the AirPort network from the pop-up list. If the network is secure, you are prompted for a password. You can enter a private network name by choosing the ellipsis (...) and typing the name.
9. If you chose AirPort as the network in step 5, when you see the AirPort status icon indicating signal strength, click Continue in Remote Install Mac OS X.
10. You can now reinstall software, reset the password, or run Disk Utility.

Reinstalling software using the MacBook Air SuperDrive

To install Mac OS X and applications that came with the MacBook Air, using a MacBook Air SuperDrive

1. Connect the MacBook Air SuperDrive to the MacBook Air, and insert Mac OS X Install Disc 1.
2. Double-click "Install Mac OS X and Bundled Software."
 - To install just applications, select Install Bundled Software Only.
 - To install iCal, iChat AV, iSync, iTunes, Safari, and the iLife '08 applications, you need to select "Install Mac OS X and Bundled Software."
3. Follow the instructions, selecting the MacBook Air as the destination volume for installation.

Note: To restore Mac OS X on the computer to the original factory settings, click Options in the "Select a Destination" pane of the Installer, and then select "Erase and Install."

To reset the password, using a MacBook Air SuperDrive

1. Connect the MacBook Air SuperDrive to the MacBook Air, and insert Mac OS X Install Disc 1.
2. Restart the MacBook Air and hold down the C key as it starts up.
3. Choose Utilities > Reset Password from the menu bar. Follow the onscreen instructions.

To use Disk Utility from a MacBook Air SuperDrive

1. Connect the MacBook Air SuperDrive to the MacBook Air, and insert Mac OS X Install Disc 1.
2. Restart the MacBook Air and hold down the C key as it starts up.
3. Choose Installer > Open Disk Utility. When Disk Utility opens, follow the instructions in the First Aid pane.

Troubleshooting Tips and Tricks

Resetting the System Management Controller (SMC)

The System Management Controller is an integrated circuit (computer chip) that is on the logic board. As the name implies, it is responsible for power management of the computer. It controls backlighting, hard drive spin down, sleep and wake, some charging aspects, trackpad control, and some input/output as it relates to the computer sleeping.

Over time, the settings in the System Management Controller may become unusable, which can result in operational anomalies with the computer. Examples include not turning on, not waking from sleep, not charging the battery, or not recognizing the AC Adapter, among others.

Don't reset the SMC if the computer is unresponsive. An SMC reset should only be a last resort in cases where a hardware failure of the power management system is suspected. Performing an SMC reset returns the hardware, including NVRAM (Non-Volatile Random Access Memory), to default settings and forces the computer to shut down.

For most situations, a restart is sufficient. If the computer has stopped responding, try each one of these steps, one by one. Test in between steps to see if it has worked. If one step works, don't worry about the next, as you're up and running! Only go on to reset the SMC if you've tried all of the steps listed here and the computer still isn't working.

1. Force Quit (Option-Command-Escape).
2. Force Shut Down (press the power button for 10 seconds).

Reset the SMC as follows only if the above steps did not resolve the situation.

1. If the MacBook Air is on, turn it off.
2. Connect the power adapter to a working power source.
3. Press (left) Shift-Control-Option along with the power button once.

Note: Only use the keys on the left side of the keyboard.

4. Wait 5 seconds and press the power button to start the MacBook Air.

Caution: Reset the SMC only when the MacBook Air has been properly shut down. This prevents file system corruption.

While the power adapter does not need to be connected to reset the SMC, it may be necessary in situations where the battery needs charging, or the MacBook Air has been without power for an extended period of time.

Display off and sleep indicator light on

When the system is running but the video is not illuminated (for example, briefly upon startup, or when energy saver dims the video while the system is still awake), the sleep indicator light remains on. This feedback is to alert the user that the system is not shut down. It is possible, however, that this signal may fail if the system has crashed. As such, you can use the next test to see if power is present in an apparently "off" system.

System powered test using Caps Lock LED

There are situations when the system is giving indications that it is shut down (no sleep light, no hard drive access, screen is dark, no fan, and so on); however, the logic board may still be active. In this case, the logic board is drawing power and generating heat.

Warning: In this situation, if the computer is placed in an enclosed environment like a carrying bag the computer can overheat.

You can potentially verify this situation by pressing the Caps Lock key. If the LED glows, the power manager is actively running on the logic board. If pressing the Caps Lock key or other attempts to wake the machine have failed (including closing the lid to put it to sleep and reopening it to wake it), hold the power button down for six seconds to force a shutdown of the computer. Restart the system to check that it starts up normally.

Note: Given that the keyboard in MacBook Air is a USB device, it may not respond if the operating system has crashed. Thus, despite the fact that the caps lock LED does not light up, the computer may still be drawing power. If in doubt, hold the power button down for six seconds to force a shutdown of the computer.

MacBook Air Firmware Updates

Firmware is software that is written into memory circuits, such as flash memory, that can retain software code indefinitely, even when power is not available to the hardware. Firmware on Intel Mac computers is designed to be updated if necessary through a software update.

EFI and SMC firmware is stored on the MacBook Air logic board. EFI firmware updates address the Boot ROM, and SMC updates address the System Management Controller firmware. The SMC manages fans and other environmental parameters that are independent of the Boot ROM.

Firmware symptoms can be easily mistaken for hardware issues (e.g. overheating issues, fan noise issues, etc.). Always check both EFI and SMC firmware versions, and update if necessary before replacing any hardware components in the MacBook Air.

Please follow the steps outlined in Knowledge Base article 303364 About firmware updates for Intel-based Macs to perform an EFI and/or SMC firmware update.

Information about firmware versions for Intel Macs can be found in Knowledge Base article 303880 Mac OS X: Firmware Updates for Intel-based Macs.

Software Troubleshooting Tips and Tools

Mac OS X 10.5.1 or later only

MacBook Air requires Leopard 10.5.1 [build 9A2324] or later. Make sure all software updates are applied before starting troubleshooting.

Login window and account

Mac OS X requires at least one user account to be established—the Administrator’s account. By default, the Accounts system preference pane has the “Log in automatically [Admin’s name]” checked. This automatic login setting allows the system to boot into the Finder without having a login prompt. However, if this box is not checked, you need a password to get to the Finder, and you need to create a user account after you reinstall system software.

Customer forgot password

If the customer forgot the password for the computer:

1. Insert the MacBook Air Mac OS X Install Disc 1.
2. Restart the computer while holding down the C key on the keyboard.

-
3. When the installer appears, choose Reset Password under the Installer Utilities menu.
 4. Follow the on-screen instructions.

Safe Mode

Safe Boot is a special diagnostic way to start Mac OS X when troubleshooting. Safe Mode is the state Mac OS X is in after a Safe Boot. Starting up in Safe Mode does five things to simplify the startup process and operation of the computer:

- It forces a directory check of the startup (boot) volume. It is identical to using Disk Utility's Repair Disc or the `fsck -fy` terminal command.
- It loads only required kernel extensions (some of the items in `/System/Library/Extensions`).
- It disables all fonts other than those in `/System/Library/Fonts`
- It moves to the Trash all font caches normally stored in `/Library/Caches/com.apple.ATS/(uid)/`, where (uid) is a user ID number such as 501.
- It disables all startup items and any Login Items.

To start up into Safe Mode (to Safe Boot), do this:

1. Be sure the computer is shut down.
2. Press the power button.
3. Immediately after you hear the startup tone, press and hold the Shift key.

Note: The Shift key should be held as soon as possible after the startup tone but not before.

4. Release the Shift key when you see the screen with the gray Apple and progress indicator (looks like a spinning gear). After startup, the words "**Safe Boot**" appear in red letters under the Apple logo on the Mac OS X login screen.

Note: The Safe Boot startup process takes longer than a normal startup. It can be quite long (several minutes) depending on the amount of time it takes to check and repair the directory (if needed).

5. To exit Safe Mode, restart the computer normally, without holding down any keys during startup.

Knowledge Base Articles

These troubleshooting articles can be searched from <http://www.apple.com/support>.

107392 What is Safe Boot, Safe Mode?

107393 Mac OS X: Starting up in Safe Mode

107394 Safe Boot takes longer than normal startup

106692 Mac OS X: Troubleshooting Installation and Software Updates

106693 Mac OS X: Troubleshooting Installation From CD-ROM

106464 Your Mac won't start up in Mac OS X

25398 Mac OS X: How to troubleshoot a software issue

MacBook Air 45W MagSafe Power Adapter Compatibility

The MacBook Air 45W MagSafe Power Adapter is specially designed to work with the MacBook Air. It has a low-profile, right-angled MagSafe connector to fit in the slim area under the bottom case while the unit is resting on a hard, flat surface. Although a 60W or 85W MagSafe adapter from a MacBook or MacBook Pro can provide adequate power to operate and charge MacBook Air, these adapters are not recommended because the connector does not share the same design to stay seated properly in the MacBook Air MagSafe port.

Likewise, don't use the MacBook Air 45W MagSafe Power Adapter to operate or charge existing MacBook and MacBook Pro computers that require the 60W or 85W MagSafe Power Adapter. Always use the proper power adapter intended for use with each product.



Related Knowledge

- [Multi-Touch Trackpad Quickstart Guide](#)
- [MacBook Air: Read Before You Install \(PDF\)](#)
- [KBase article 307300, MacBook Air: Built-in camera may produce jumpy video](#)
- [KBase article 307286, MacBook Air: Using wireless routers with WEP and Mac OS X Remote Install](#)
- [KBase article 303319, Resetting an Apple portable's System Management Controller \(SMC\)](#)
- [KBase article 307294, MacBook Air: Using the trackpad and keyboard](#)
- [KBase article 307239, MacBook Air: Using Apple Hardware Test](#)
- [KBase article 307288, MacBook Air: Use of some older base stations may cause networking issues](#)
- [KBase article 307320, MacBook Air: Troubleshooting DVD or CD Sharing](#)
- [KBase article 307137, Troubleshooting a MacBook Air that won't turn on](#)
- [KBase article 307141, MacBook Air: Sharing Discs with Remote Disc](#)
- [KBase article 307316, MacBook Air: Remote Disc does not play DVD movies or ripped CD media](#)
- [KBase article 307292, MacBook Air: Reinstalling software using the MacBook Air SuperDrive](#)

-
- [KBase article 307242](#), MacBook Air: Reinstalling software using Remote Install Mac OS X
 - [KBase article 307289](#), MacBook Air: Optimizing Airport performance while using Bluetooth
 - [KBase article 307295](#), MacBook Air: Optimize wireless communications when using an external display
 - [KBase article 307314](#), MacBook Air: Migration Tips and Tricks
 - [KBase article 307317](#), MacBook Air: How to Enable Remote Disc on a Mac or Windows-based computer
 - [KBase article 307310](#), MacBook Air: External USB Optical drive required for installing Boot Camp
 - [KBase article 307315](#), MacBook Air: External ports
 - [KBase article 307319](#), MacBook Air: Remote Disc “Ask me before allowing others to use my DVD Drive” feature
 - [KBase article 307299](#), MacBook Air: Bluetooth devices may stop working after waking MacBook Air from sleep
 - [KBase article 307284](#), MacBook Air: About the diagnostic LED
 - [KBase article 307297](#), MacBook Air: 3D graphics applications less responsive when after heavy use
 - [KBase article 307285](#), MacBook Air: Ejecting optical media with Windows and Optical Disk Sharing
 - [KBase article 307322](#), MacBook Air: Headphone jack and third-party audio product compatibility



Troubleshooting Steps

You perform the first few steps of troubleshooting regardless of whether there is a repairable problem or damage.

Gather Information

Gather the normal information about the problem. (If you are not familiar with the normal information to gather, or any of the other steps, see [General Troubleshooting Theory](#).)

Verify the Problem

Verify that the symptom exists as the customer reports it.

Try Quick Fixes

Special quick fixes that apply to this computer include:

- Familiarize yourself with the unit's normal operating temperature (see Knowledge Base document [30612](#))
- Make sure cable connectors are fully seated
- Reset the SMC. (See Knowledge Base document [303319](#)).

For more details, see the Symptom Charts section.

Run Diagnostics

The following diagnostic tools are available for this product:

- Apple Hardware Test
- Apple Service Diagnostic

See Knowledge Base document [112125](#), "Service Diagnostic Matrix," to download the appropriate disc image.

Try Systematic Fault Isolation

There are no special systematic fault isolation techniques for this product.

Research

If you have not located the trouble following the steps thus far, try researching the symptoms.

Research resources include:

- Symptom Charts section of this manual
- GSX
gsx.apple.com
Enter serial number and click Coverage Check
- Service Source
service.info.apple.com
Check Quick Links and/or Technical Resources
Check options under appropriate Product Service pop-up menu
- Product support page
service.info.apple.com
Choose MacBook Support Page from the appropriate Product Service pop-up menu
- Knowledge Base
search.info.apple.com
- Self-paced service training
service.info.apple.com
Choose Service Training from the Product Service pop-up menu

Escalate

Follow the practices and policies of your business or agency.

Repair or Replace

Once you locate the trouble, you will most likely need to repair the unit, or mail it in to an AppleCare Repair Center, depending on the service strategy in your region. Be sure to include the CompTIA code, the troubleshooting steps you performed, and the results in the Service Instructions section of GCRM and/or GSX.

If the symptoms point to a component on the logic board, use the [block diagram](#) at the end of this chapter to help determine whether you need to replace the entire logic board.

Verify the Repair

To verify the repair:

1. Try to recreate the original symptoms. You should not be able to. (If you can, return to the beginning of the troubleshooting flowchart.)
2. Perform the preventive maintenance tasks for this product. For this computer this includes only cleaning the display and case.

Inform the User

Include in the case notes all that you have done. The customer may like a copy of any diagnostic reports.

Important: For any unit you send on to a repair center, include the CompTIA code, symptoms, steps to reproduce, and troubleshooting steps you have completed thus far in the Service Instructions section of GCRM and/or GSX. (Service Instructions are also known as FAI notes.)

Complete Administrative Tasks

There are no particular administrative tasks for this product, other than those required by the internal policies of your business or agency.



Hardware Symptoms

How to Use the Symptom Charts

The Symptom Charts included in this chapter help diagnose specific symptoms related to the MacBook Air.

The steps to solve a symptom are listed sequentially. You might not need to perform every step before the symptom is resolved. Start with the first step, and then test for the symptom. If the symptom persists, replace any modules you removed, go to the next step, and test again. Continue down the list until the symptom is resolved.

Startup

Startup Sequence

If battery and/or AC power is available to the system, pressing the power button activates the startup process.

- At first, the screen remains dark. The sleep indicator light glows for a few seconds.
- Upon startup, the system performs a power-on self test (POST). See [POST Error Codes](#) listed later for failure results.
- If the system is not muted, a startup chime sounds. The display's backlight illuminates the screen, and the sleep indicator light turns off.
- The screen turns gray, the Apple logo appears, and then the spinning gear appears.
- After several seconds, either the Login window or the Finder desktop should appear. This depends on whether automatic login is enabled or not.

No Power, No Video

The computer will not power on (no sleep indicator light, no fan movement, no hard drive spin-up, no Caps Lock LED illumination when pressed, and no display illumination).

Note: After each step, check that the system is not supplying power to the logic board. If you see the sleep indicator light come on or the Caps Lock LED illuminate when the key is pressed, then the system is drawing power. In this case, hold down the power button for six seconds to make sure the system is shut down before working on the system. At this point, the issue is no longer a "No Power, No Video" problem. Move on to the [Power, but No Video](#) troubleshooting section.

Note: Examine the display carefully. An image may be barely present on the screen, but with no backlight clearly illuminating the image. In this case, the system is working properly except for the backlight. Use the [Display: Dim Video](#) troubleshooting section to resolve this issue.

-
1. Remove any connected peripherals.
 2. Unplug the power adapter from the power outlet and from MacBook Air. Wait one minute. Plug it back into the wall first, then to MacBook Air. Make sure the power outlet is working by plugging in another device (such as a lamp). When you plug the adapter back into the computer, the power adapter LEDs should light up green or amber.
 3. Connect a known-good Apple 45W Portable Power Adapter and power cord/plug to a known-good power outlet. With the DC plug properly inserted, the LED should light up; if not, go to the “MagSafe connector” troubleshooting section.
 4. **Note:** Inspect the MagSafe port on the computer for debris, such as metal stuck to the magnet in the port, which might prevent the connector from seating properly. On the adapter side, look at the DC connector for dust or other debris and check whether pins are missing, bent or stuck down. See Knowledge Base article 303083: Use and Cleaning of Power Adapter with MagSafe Connector for instructions on cleaning the adapter.

To perform a soft restart, press the control key, the command key, and the power button simultaneously and hold for three seconds.

5. Reset PRAM. (After restart, hold down the Command-Option-P-R keys until you hear the startup chime at least one additional time after the initial startup chime).
6. Reset the SMC (power manager) as described in “Resetting the System Management Controller (SMC)” under “Troubleshooting Tips and Tricks” in the previous section.
7. Start up the system, and check the sleep indicator LED. If the indicator LED lights up briefly, then the logic board is getting power and completing the boot cycle. Go to the “Power, but No Video” troubleshooting section.
8. Verify that the IPD flex cable is connected properly to the logic board.
9. Disconnect the AirPort/Bluetooth flex cable from the logic board and start up the computer. If it starts, shut it down and check the flex cable connector and the connector on the logic board and replace the damaged parts. If it appears OK, try a known-good AirPort/Bluetooth card.
10. Replace battery with a known-good battery. Make sure the battery cable to the logic board is fully seated.
11. Reseat these flex cables:
 - Hard drive flex cable (boots to flashing folder if not connected or corrupt)
 - Display LVDS cable
12. Inspect flex cable connectors and their terminals on the logic board for damage and replace any damaged parts.
13. Replace the logic board.

Power-On Self Test (POST) Error Codes

The computer automatically performs a power-on self test when it is turned on after being fully shut down (not a restart). This section describes what to do if you hear beeps during startup. When this occurs, the sleep indicator light stays on, occasionally flashing.

MacBook Air relies on a combination of tones and blinking sleep indicator light flashes to display power-on self test (POST) error codes.

If the logic board has a RAM chip issue, the screen remains black and the LED blinks once per second to signal the error.

If the MacBook Air's diagnostic LED displays five flashes upon startup, and the pattern repeats after a brief pause, the computer's battery may require service. If the power adapter is present and connected to a working power source, the MacBook Air will continue to start up normally despite a defective battery.

This 5-flash LED diagnostic may also occur when waking the computer from sleep if the power adapter is connected and the battery requires service. This informs the customer that the battery requires service while accommodating continued operation until it can be diagnosed.

Related Knowledge Base articles:

303363: Intel-based Mac: Startup sequence and error codes, symbols

307284: MacBook Air: About the Diagnostic LEDs

Blue screen appears (a spinning disc cursor may also be visible), Prohibitory Sign appears (a), Kernel Panic dialog box appears (b), or Gray screen during startup

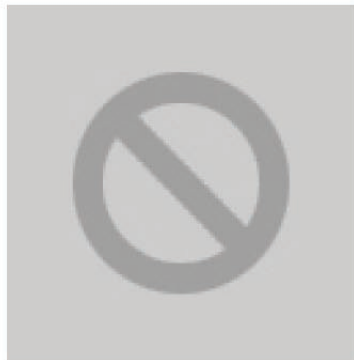

a) Prohibitory sign



b) Kernel panic dialog box

1. Make sure all external devices are disconnected. If the kernel panic goes away, troubleshoot the external device by reconnecting each device until the panic occurs.
2. If experiencing random kernel panics, check for available software or firmware updates.

For assistance in software troubleshooting, go to Knowledge Base article 106464: Mac OS X: Troubleshooting a Startup Issue and article 106805: "Broken folder" icon, prohibitory sign, or kernel panic when computer starts.

Flashing question mark appears on the screen

Note: The system only starts up with the Mac OS X version (or later) that shipped with it. For more information, refer to Knowledge Base article 307333: MacBook Air: About the Mac OS X 10.5 Leopard Installation Media

3. Refer to the General Troubleshooting section regarding “Reinstalling software using Remote Install Mac OS X or Using the MacBook Air SuperDrive.”
4. When the Installer opens, select Disk Utility from the Installer menu under Utilities.
5. When Disk Utility opens, all mounted disk and volumes are listed on the left side. If you don’t see the internal hard drive, the system is not recognizing it. Skip to the next step. Otherwise, select the internal hard drive icon, and follow the instructions under the First Aid tab to verify the hard drive, and repair if needed. Restart the computer.
6. If Disk Utility is unable to repair a persistent directory issue or corrupt file information, consult the following articles for possible solutions:
 - 106214: Using Disk Utility and fsck to resolve startup issues or perform disk maintenance
 - 25505: Directory Issue Verification or Repair Is Not Part of Installation
 - 25770: Handling “overlapped extent allocation” errors reported by Disk Utility or fsck
 - 302411: Disk Utility reports “Underlying task reported failure” when repairing a volume
7. If the hard drive is still not recognized, refer to the “Internal Hard Drive Not Recognized” troubleshooting section.
8. Reinstall the system software. Refer to the sections in the General Troubleshooting chapter regarding “Reinstalling software using Remote Install Mac OS X” or “Reinstalling software using the MacBook Air SuperDrive.”

Note: Don’t forget to install both the Mac OS X system and application software.

For further assistance in software troubleshooting, go to Knowledge Base article:

- 58042: A flashing question mark appears when you start your Mac
- 88410: SMART: A Brief Description

Power, but No Video

The computer begins to power up, the fans and hard drive spin, the Caps Lock key lights up when pressed, but there is no startup chime or video.

Note: Examine the display carefully. An image may be barely present on the screen, but with no backlight clearly illuminating the image. In this case, the system is working properly except for the backlight. Use the “Display: Dim Video” troubleshooting section to resolve this issue.

1. Reset the SMC (power manager) as described in “Resetting the System Management Controller (SMC)” under “Troubleshooting Tips and Tricks” in the previous chapter.
2. Try connecting an external display to check for intact video signal. If external video appears, check the system for any pending software or firmware updates and update accordingly.
3. Verify that the LVDS cable connector is seated properly and the cable is not damaged.

4. Replace the display assembly.
5. Check all cable connections to the logic board. Try restarting.
6. Replace the logic board.

System shuts down intermittently

1. Disconnect all external peripherals.
2. Consult system.log for possible shutdown error codes using Console (in Utilities folder).

Shutdown Code	Potential Indication, Issue and/or Fix
0	Expected normal behavior.. SMC did not initialize sleep
3	Expected normal behavior.. power button pressed for more than four seconds to force shutdown.
5, -5	Expected normal behavior.. regular shutdown or normal sleep
2, -60	Try charging a drained battery.
-70	Replace top case.
-4, -72, -84, -95	1) Reapply thermal paste, 2) replace thermal module.
-74, -103	1) Swap battery for KGB battery, 2) replace battery.
-75	Check power adapter plug and/or cable.
-78, -79, -86	Charger circuit on logic board.. replace logic board.
-82	Check thermal sensors (see step 5 below).

3. Make sure the system is not overheating, the air vents are clear, and the unit was not used on a soft surface.
4. Check that the fan cable is connected and operational.
5. Run Apple Service Diagnostic to determine if any of the thermal sensors are malfunctioning. Replace any failing sensors. See chart below for correlation between error code and part.

Error Code	Part Location
Tc0P, Ts0S	Logic board
Ts0P	Top case (trackpad sensor / IPD board)
Tp0P	Battery

6. Check that the thermal paste between the thermal module and logic board is adequate by unscrewing the logic board screws and gently pulling up on the board to verify resistance. If no resistance, apply new thermal paste (see **Thermal Module** in the take apart chapter).
7. Replace the logic board.

System shuts down almost immediately after startup

1. Disconnect all external peripherals.
2. After charging for a while, if the battery does not seem to charge, or if it is fully charged but quickly discharges, verify with a known-good battery, and replace the faulty battery.
3. Check battery connection to logic board.

-
4. If the sleep indicator light briefly illuminates just before the system shuts down, check the thermal sensor connection to the logic board. It should be fully seated with no damage to the wiring.
 5. Replace the logic board.

System shuts down when USB device is plugged in

Note: The MacBook Air may shut down when a USB device is plugged in if the device is defective or the USB port has shorted out.

Isolate the defective USB device by plugging each in one by one, until you find the device that is causing the issue.

Refer to Knowledge base article 307296: MacBook Air: Plugging in a USB Device causes Macbook Air to shut down.

Application Quits, Kernel Panic or other booting problems

1. If a specific application quits, replace the application. Verify that the application is compatible with OS X.
2. Reset PRAM. (After restart, hold down the Command-Option-P-R keys until you hear the startup chime at least one additional time after the initial startup chime).
3. Run Disk Utility from the Software Install and Restore DVD. Refer to sections in the General Troubleshooting section regarding “Reinstalling software using Remote Install Mac OS X or Reinstalling software using the MacBook Air SuperDrive.”
4. Perform a clean install of the system software using the Software Install and Restore DVD. Refer to sections in the General Troubleshooting section regarding “Reinstalling software using Remote Install Mac OS X or Reinstalling software using the MacBook Air SuperDrive.”

Note: Restore images are available at <http://service.info.apple.com>. Select “Disc Images.”

5. Restart the system.
6. Run Apple Service Diagnostic (ASD) in loop mode (Control-L) for an extended time to test the memory and logic board functions. If the test finds bad memory or other logic board related failure, replace the logic board.

Battery

Warranty Note: If the battery is determined to be the root cause of the customer issue, see Knowledge Base article 500644: Portable Computer Battery Screening Process for Apple Service Providers to determine if the battery can be replaced under the one-year limited warranty.

Before troubleshooting battery-specific issues, make sure to check Software Update in the System Preferences or see the Apple Software Updates web page for battery-related software updates.

The battery won't charge

1. Remove any externally connected peripherals.
2. Connect a known-good Apple 45W Portable Power Adapter and power cord/plug to a known-good power outlet. With the DC plug properly inserted, the LED should light up; if not, go to the "MagSafe connector" troubleshooting section.
1. Reset the SMC (power manager) as described in "Resetting the System Management Controller (SMC)" under "Troubleshooting Tips and Tricks" in the previous chapter.
2. Try a known-good battery.
3. Replace logic board.

Battery won't charge completely

If the battery appears to stop charging between 95 and 99 percent, this is normal operation. Refer to Knowledge Base article 88344: Apple portable computer's battery does not show a full charge in Mac OS X.

Short battery life

There are three categories to consider:

1. There is a system issue (not the battery).
 - If you have the customer's power adapter, plug it into a known-good outlet and verify that it can charge the system. Also make sure it is the correct 45W adapter.
 - If you don't have the customer's power adapter, plug a known-good 45W adapter into a known-good outlet. Verify that the MagSafe adapter can charge the system.
 - Check whether the customer's system is set up for heavy battery power use (AirPort on, optical media always in drive, Energy Savings set to Highest Performance, etc).
 - Use Activity Monitor to check for any runaway applications. Stop any runaway processes.
 - Test the computer with all third-party devices (printers, hubs, third-party keyboard or mouse) removed.
 - Reset the SMC (power manager) as described in "Resetting the System Management Controller (SMC)" under "Troubleshooting Tips and Tricks" in the previous section.
2. The battery needs calibration, or it is nearing the end of its useful life.
 - Calibration should be done when you first use the battery, and every few months after. It allows the battery to properly calculate how much power is left in the battery.
 - The battery is a consumable part. It can be charged and discharged only so many cycles before it becomes depleted and can no longer hold a charge.
 - Check the status of the battery with the Battery Health Monitor, located in Apple System Profiler: Battery Information: Health Information: Battery Health. If the battery health status reads "Good" or "Fair", then re-calibration may improve performance.

Note: The battery calibration procedure is as follows:

- a. Plug in the power adapter and fully charge your battery until the light on the power adapter plug changes to green and the on-screen meter in the menu bar indicates

that the battery is fully charged.

- b. Allow the battery to rest in the fully charged state for two hours or longer. You may use your computer during this time as long as the adapter is plugged in.
- c. Disconnect the power adapter with the computer on and start running it from the battery. You may use your computer during this time. When your battery gets low, the low battery warning dialog appears on the screen.
- d. Keep your computer turned on until it goes to sleep. **Note:** Save work and close all applications when the battery gets low, before the system goes to sleep.
- e. Turn off the computer or allow it to sleep for five hours or longer.
- f. Connect the power adapter until the battery is fully recharged again.

3. The battery has a defect.

Symptoms include, but are not limited to, a relatively new battery that will not charge at all, reports an “X” in the menu bar icon, or reports a ‘Poor’ performance level in the Battery Health Monitor. In the first two cases, the battery may need calibration—try this first. In addition, after troubleshooting at the system level, if the battery is causing abrupt shut-downs or goes to sleep without warning, the battery can be considered severely degraded. If this is the case, replace the battery.

MacBook Air Battery Diagnostic at Startup

If the MacBook Air’s diagnostic LED displays five flashes upon startup, and the pattern repeats after a brief pause, the computer’s battery may require service. If the power adapter is connected to a working power source, the MacBook Air will continue to start up normally; however, the battery should still be serviced.

This 5-flash LED diagnostic may also occur when waking the computer from sleep if the power adapter is connected and the battery requires service. This is intended to indicate a defective battery while still accommodating continued operation until it can be serviced.

Diagnostic Flash Sequence:

- a. Sleep indicator light is solid. This confirms that the unit is receiving power, even though the system has no video.
- b. Sleep indicator light flashes five times to indicate a battery failure.
- c. Sleep indicator light returns to solid status. Again, this indicates that the system is powered, even though video and battery power are not available.

Useful Knowledge Base articles:

- 86440: Apple Portables: Battery Life
- 86284: Calibrating your computer’s battery for best performance
- 304301: MacBook and MacBook Pro: Battery not recognized after being fully drained
- 307284: MacBook Air: About the Diagnostic LEDs

AirPort/Bluetooth Card

AirPort is not recognized

1. In Mac OS X, use Software Update in System Preferences or see the Apple Software Updates web page to make sure the latest version of AirPort Extreme software is installed.
2. Reset PRAM. (After restart, hold down the Command-Option-P-R keys until you hear the startup chime at least one additional time after the initial startup chime).
3. Open AirPort in System Preferences and make sure AirPort is on and Base Station is selected.
4. Reseat the AirPort/Bluetooth card flex cable.
5. Remove and reinstall the AirPort Extreme software.
6. Replace with known-good AirPort/Bluetooth card.
7. Replace the logic board.

AirPort connection is slow

1. Move computer closer to the AirPort Base Station or other AirPort device.
2. Check the number of users trying to use AirPort in the area. Too many users accessing the network at the same time can cause heavy network traffic. To improve network connection speed, add additional AirPort Base Stations.
3. Check for other changes in the environment that may cause interference with the AirPort signal. For more information, consult these Knowledge Base articles: 58543: AirPort: Potential sources of interference, 307289: MacBook Air: Optimizing AirPort Performance while using Bluetooth, and 307296: MacBook Air: Optimize Wireless Communications when using an External Display
4. Use Software Update in System Preferences or see the Apple Software Updates web page to make sure the latest version of AirPort Extreme software is installed.
5. Restart the computer.
6. Check the AirPort Extreme antenna connection to the AirPort Extreme Card. Make sure each connector is securely connected and placed in the proper order.
7. Reseat the AirPort/Bluetooth card flex cable.
8. Replace with known-good AirPort/Bluetooth card.
9. Check antenna wires coming from clutch barrel for nicked insulator or crimped wire. If damaged, replace the display assembly.
10. Replace the logic board.

Bluetooth

Bluetooth system preference pane does not show up under hardware section of System Preferences

1. Check for software/firmware updates on the web.
2. Check the AirPort/Bluetooth flex cable connection to the trackpad flex cable.
3. Check the top case flex cable connection to the logic board.
4. Replace the AirPort/Bluetooth card.
5. Replace the AirPort/Bluetooth card flex cable.
6. Replace the logic board.

AirPort/Bluetooth card not recognized by other devices

1. Open Bluetooth in System Preferences, and make sure that Discoverable is checked under the Settings tab.
2. Make sure the AirPort/Bluetooth antenna is properly installed.
3. Check that the AirPort/Bluetooth antenna is connected to AirPort/Bluetooth card.
4. Replace with known-good AirPort/Bluetooth card.
5. Replace logic board.

Display

When displaying a single color over the screen area, the LCD panel shows one or more pixels that are not properly lit

To determine if the display has an acceptable number of pixel anomalies, follow the steps below:

1. Set the display image to one of the following colors: all-white display, all-red display, all-green display, or all-blue display. Knowledge Base article 112125: Service Diagnostics Matrix, has the LCD Tester Diagnostic Utility that generates these patterns on the screen.
2. Using a jeweler's loupe, pocket microscope, or other magnifying device, identify and count each pixel anomaly:
 - Bright subpixel anomaly = subpixel that is always on
 - Dark subpixel anomaly = subpixel that is always off

Acceptable Number of Subpixel Anomalies

Bright	Up to 3
Dark	Up to 5
Combination	Up to 7

3. If the number of subpixel anomalies exceeds the acceptable number listed in the above chart, replace the display assembly.

Replace

Bright	4 or more
Dark	6 or more
Combination	8 or more

4. If the number of subpixel anomalies is acceptable, explain to the customer that the pixel anomalies are within specifications, and no repair is necessary.

Important: Do not release the specifications to customers. Instead, inform them that a certain number of subpixel anomalies are considered acceptable, and these factors apply to all manufacturers using LCD technology—not just Apple products.

When speaking with customers, please use the following explanation:

Active-matrix LCD technology uses rows and columns of addressable locations (pixels) that render text and images on screen. Each pixel location has three separate subpixels (red, green, and blue) that allow the image to be rendered in full color. Each subpixel has a corresponding transistor responsible for turning the subpixel on or off.

There are typically millions of these subpixels on an LCD display. For example, the LCD panel used in Apple displays is made up of 2.3 million pixels and 6.9 million red, green, and blue subpixels. Occasionally, a transistor does not work perfectly, which may result in the affected subpixel being turned on (bright) or turned off (dark). With the millions of subpixels on a display, it is quite possible to have a low number of faulty transistors on an LCD. Therefore, a certain number of subpixel anomalies are considered acceptable. Rejecting all but perfect LCD panels would significantly increase the retail price for products using LCD displays. These factors apply to all manufacturers using LCD technology—not just Apple products.

Hard Drive

Internal hard drive will not initialize

1. Run Disk Utility from the Software Install and Restore DVD. Refer to sections in the General Troubleshooting chapter regarding **Reinstalling software using Remote Install Mac OS X** or **Reinstalling software using the MacBook Air SuperDrive**.
2. When the Installer opens, from the Installer menu, select Open Disk Utility.
3. If the hard drive is recognized, format it under the Erase tab.

To format a blank hard drive:

- Boot from the Mac OS X Install Disc 1 which came with the system (see step 1 above).
- Select the desired language.
- Select Disk Utility, under the Utilities menu.
- Click the Erase tab.
- Select the hard drive in the Source pane.
- Verify that Mac OS Extended (Journaled) is selected.
- Click Erase.

-
4. Continue using the Mac OS X Install Disc 1 to install the system software.
 5. Restart the computer, and run Software Update to install updates. Continue to run Software Update until no more updates are listed.

Important: If the computer is under warranty and data recovery is required, refer to Knowledge Base article 31077: DriveSavers: Hard Drive Data Recovery & Warranty Implications for important information.

System boots to flashing question mark:

Refer to the previous “Flashing Question Mark” section for tools to troubleshoot this issue.

Internal hard drive not recognized:

1. Boot from the MacBook Air Mac OS X Install Disc 1. Refer to sections in the General Troubleshooting chapter regarding “Reinstalling software using Remote Install Mac OS X” or “Reinstalling software using the MacBook Air SuperDrive.” See Knowledge Base article 307333: MacBook Air: About the Mac OS X 10.5 Leopard Installation Media.
2. If not the primary boot volume, use Apple System Profiler to check under ‘Hardware: Serial-ATA’ option to see if the system recognizes the hard drive hardware.
3. Check the SMART status. If the status is ‘About to Fail’ or ‘Failing,’ replace the hard drive.
4. Reseat the hard drive flex cable.
5. Check the hard drive flex cable for damaged connectors (a connector peeled off the flex cable, for example); if damaged, replace the hard drive flex cable.
6. If still not recognized, replace the hard drive.
7. Replace the logic board.
8. Reinstall the system software. Refer to the sections in the General Troubleshooting chapter regarding “Reinstalling software using Remote Install Mac OS X” or “Reinstalling software using the MacBook Air SuperDrive.”

Note: Don’t forget to install both the Mac OS X system and application software.

Important: If the computer is under warranty and data recovery is required, refer to Knowledge Base article 31077: DriveSavers: Hard drive data recovery and warranty implications for important information.

Apple Remote

Note: To use the Apple Remote with DVD movies or ripped CD media on the MacBook Air, use the MacBook Air SuperDrive. Using the Apple Remote with DVD movies or burned or ripped CD media through the Remote Disc feature is not supported on MacBook Air.

Refer to Knowledge Base article 307316: MacBook Air: Remote Disc does not play DVD movies or ripped CD media

Remote won't communicate with system applications such as iTunes or iPhoto, or with the optical drive.

Make sure of the following when using the (infrared) Apple Remote:

- You are within 30 feet of the front of the computer.
 - You have an unobstructed line-of-sight to the front of the computer.
 - You are pointing the lens end of the Apple Remote directly at the front of the computer.
 - The computer is powered on and awake.
 - The "Disable remote control infrared receiver" check box in the Security pane of System Preferences is NOT checked.
1. Make sure the active application works with Apple Remote. Apple Remote uses Front Row, and from Front Row it can access DVD Player, iPhoto, iTunes, and QuickTime Player.
 2. Make sure the remote is paired with the computer. Access the System Preferences -> Security pane and check "Unpair" if available. Close the Security pane, and re-pair the Apple Remote with the computer. See Knowledge Base article 302545: Pairing your Apple Remote with your computer.
 3. Use a digital camera to test your Apple Remote.

If you have a digital camera or DV camera with an LCD display, you can use it to see if your Apple Remote is emitting a signal. Infrared beams are invisible to the human eye, but most digital cameras and video cameras use Charged-Coupled Device (CCD) chips or image sensors that are sensitive to infrared light.

To use a camera to test your Apple Remote, follow these steps:

- Turn on your digital camera or DV camera and remove any lens cover.
 - Point your Apple Remote toward the display latch button.
 - Press and hold the Menu button on the remote while looking at your camera's LCD display.
 - If you see a faint blinking light coming from the Apple Remote in the camera's LCD, then the remote is working properly.
 - If you don't see any blinking light in the camera's LCD, replace the battery in your Apple Remote and then test it again with your computer.
4. Replace the Apple Remote battery. See Knowledge Base article 302543: How to replace the Apple Remote battery.
 5. Replace the Apple Remote.

Infrared Receiver

Note: Infrared transmission loses strength in daylight. If the remote control is being used near a bright window or outdoors, the system may not respond.

Supported applications do not respond to input from the remote control

1. Make sure "Disable remote control infrared receiver" check box is not checked.
2. If "Unpair" is available in the Security pane of System Preferences, another Apple Remote may

be paired to the computer (pairing allows only one Apple Remote to control the computer). To delete a pairing between the remote and the MacBook Air, click Unpair. (You may have to enter your Administrator password to make changes in the Security preference pane.)

For further instruction, consult Knowledge Base article 302545: Pairing your Apple Remote with your computer.

3. Perform the checks above under “Apple Remote” to verify that the Apple Remote is functioning correctly, and then retest.
4. Verify that the infrared sensor can be seen in Apple System Profiler. Open Apple System Profiler, and check USB section under the Hardware tab to see that IR Receiver appears under the USB Bus tab in the USB Device Tree section.
5. Replace the logic board.
6. Replace the top case.

Built-in Camera

The built-in camera is not recognized

1. Boot the MacBook Air to the desktop and launch iChat. **Note:** You do not need to be connected to a network to use iChat to troubleshoot. Verify that the correct versions of Mac OS X and iChat are installed. Reinstall or update software as needed.
2. Open the iChat preferences and click on the ‘Video’ icon. Verify that the camera is recognized by the iChat software. Is the camera recognized?
3. Check the LVDS cable connection to logic board. Try re-seating the connector.
4. Replace the display assembly.

Camera image quality poor

1. Verify that the lens assembly for the camera is clean. Fingerprints and other contaminants can affect image quality. Clean the lens using a lint-free lens cleaning cloth, being careful not to scratch the lens. Verify that there is sufficient lighting to produce a good-quality image.
2. Lighting comparable to that found in a well-lit office should produce a good-quality image. If possible, avoid having a brightly lit background. Diffused lighting is preferred over direct lighting. Launch iChat and open the iChat preferences. Click on the Video tab. Is the video quality acceptable?

Yes: The camera is functioning normally. The image quality problems may be caused by bandwidth limitations when using iChat over the internet. Instruct the customer to use the iChat connection doctor feature to verify that there is sufficient bandwidth to have a video iChat session without a significant degradation of image quality. Consult Knowledge Base article 306687: Mac OS X 10.5: iChat System Requirements

No: The camera may not be functioning normally. Continue troubleshooting.

3. Replace display assembly and retest.

Camera recognized but no audio

1. Open the System Preferences window and click on Sound.
 - Verify that the built-in internal microphone has been selected as the sound input port.
 - Use the volume level meter to verify that the input volume settings are appropriate.
2. Launch iChat and open the iChat preferences. Click on the Video icon. Speak into the microphone while monitoring the microphone level indicator. If line meter responds, it was a settings problem.
3. Reset PRAM. (After restart, hold down the Command-Option-P-R keys until you hear the startup chime at least one additional time after the initial startup chime).
4. Check that the audio-out cable connector to the port hatch flex extension.
5. Check the microphone cable connection to the logic board.
6. Replace the display assembly.
7. Replace the logic board.

The camera is recognized but the built-in microphone's audio quality is poor

1. Open the System Preferences window and click on Sound.
 - Verify that the internal microphone has been selected as the sound input port.
 - Use the volume level meter to verify that the input volume settings are appropriate.
2. Open iMovie and create a new project. Click the Audio button and record a sound sample. If audio quality is fine, it was a settings problem.
3. Check the microphone cable connection to the logic board.
4. Replace the display assembly.
5. Replace the logic board.

Keyboard

No response from keys on the keyboard

1. Remove any connected peripherals.
2. Go to Apple System Profiler and look under the USB Bus tab in the USB Device Tree section. If you see Apple Internal Keyboard / Trackpad, go to step 6.
3. Attach an external USB keyboard. If the external keyboard doesn't work, go to step 6.
4. Boot from an external system to verify that it is not a software problem.
5. Turn off the computer. Check the keyboard flex cable connection to the IPD board (also check connectors for damage).
6. Replace the top case.
7. Replace the logic board.

No keyboard illumination

1. Go to the Keyboard system preference pane and make sure “Illuminate keyboard in low light conditions” is checked. Cover the ambient light sensor on the display bezel to the left of the camera. **Note:** The keyboard illumination is not bright enough to be seen in most well-lit spaces. In order to view the keys being illuminated, the ambient light needs to be dim.
2. Check the keyboard backlight flex cable connection to the IPD board.
3. Replace the top case.
4. Replace the display assembly.
5. Replace the logic board.

Keyboard is partially illuminated.

1. Check the keyboard backlight flex cable connection to the IPD board.
2. Replace the top case.

Keycap damaged or sticking

If a keycap is damaged, you may be able to replace just a keycap rather than the entire top case. Refer to the Additional Procedures chapter to identify the keyboard on the top case and verify whether or not to replace a keycap.

Microphone

The microphone is not working

1. Check the Sound system preference pane, and verify that the selection under the Input tab is built-in microphone.
2. Check the signal level and level meter, and adjust the gain.
3. Reset PRAM. (After restart, hold down the Command-Option-P-R keys until you hear the startup chime at least one additional time after the initial startup chime).
4. If there is no sound output from the internal speaker nor is the microphone working, verify all cable connections.
5. Check the microphone cable connection to the logic board.
6. Replace the display assembly.
7. Replace the logic board.

Modem (External)

Note: MacBook Air has no built-in modem. Apple offers an optional external USB Modem.

No modem dial tone

1. Check that the correct modem is selected in the Network Port Configuration section of the Network system preferences.
2. Verify known-good analog (not digital) telephone line.
3. Verify known-good RJ-11 telephone cable.
4. Verify customer is using USB Modem and not the Apple USB Ethernet Adapter.
5. Verify RJ-11 telephone cable is firmly installed in the modem port.
6. Inspect RJ-11 connector for pin damage. If damaged, replace modem.
7. Open Apple System Profiler, and look for Apple External Modem in the USB Device Tree under the Hardware tab. If it does not appear, check the modem USB connection.
8. Update the system software.
9. Try a known-good Apple USB modem. If it does not work in the USB port, troubleshoot the port hatch assembly.
10. Replace the logic board.

Modem does not respond (can hear dial tone)

1. Check that the correct modem is selected in the Network Port Configuration section of the Network system preferences.
2. Check that the modem application is properly configured.
3. Open Apple System Profiler, and under the Software tab look at Extensions. Check to see that the MotorolaSM56K and AppleI2SModem Family files are listed and loaded. If not, restart the system and check again. If still not visible, replace system software.
4. Open Apple System Profiler, and look for Apple External Modem in the USB Device Tree under the Hardware tab. If it does not appear, check the modem USB connection.
5. Replace the Apple USB Modem.
6. Replace the port hatch assembly.
7. Replace the logic board.

Modem intermittently disconnects or low performance

1. Verify known-good RJ-11 telephone cable (for example, the retaining clip is not broken off, and check that it is firmly installed when used. If telephone cable is bad, replace it.
2. If the issue happens with only one particular phone line, but not another, the problem may be an issue with that phone line. Under bad line conditions, try setting the modem script to start with a slower connect rate such as "Apple Internal 56K Modem (v.34)."
3. If the customer indicates the system disconnects under very high CPU loads such as burning DVDs and/or working with video editing software such as Final Cut Pro, try connecting the

modem without any application running to see how the modem performs. Use Knowledge Base article 106642: Mac OS X: Using Apple PPP Test Server to test the modem. If OK, suggest to the customer to use the modem with fewer applications running simultaneously.

4. Replace the Apple USB modem.
5. Replace the port hatch assembly.
6. Replace the logic board.

USB Port

USB port does not recognize devices

1. Shut down the computer; then press the power button to start the computer.
2. Use Software Update system preferences to verify that the latest software is installed.
3. Reset PRAM. (After restart, hold down the Command-Option-P-R keys until you hear the startup chime at least one additional time after the initial startup chime).
4. Test the port with a known-good Apple keyboard or mouse.
5. Use Apple System Profiler to verify that the computer is recognizing the bus.
6. Replace the port hatch assembly.
7. Replace the logic board.

USB device not recognized by computer

1. Shut down the computer; then press the power button to start the computer.
2. Eliminate any device chains by plugging in only one peripheral.
3. Verify that the current driver for the device is installed.
4. If the device is a camera, turn on the camera only after initiating the download with the camera application.
5. Test the USB port with a known-good Apple USB keyboard or mouse.
6. Reset PRAM. (After restart, hold down the Command-Option-P-R keys until you hear the startup chime at least one additional time after the initial startup chime).
7. Check the port hatch flex cable connection to the logic board.
8. Replace the logic board.

MagSafe Power Adapter

The power adapter LED does not turn on

1. Confirm the power adapter is connected to a known-good outlet.
2. Try replacing the AC plug or AC power cord. If the adapter works, replace the plug or cord.

-
3. Check if pins are missing or bent. If so, replace the power adapter.
 - Check the pins in the power adapter's DC plug for pins that are stuck down.

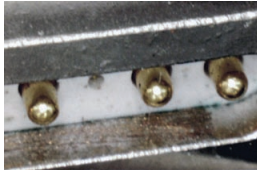

- If pins are stuck down, check for debris blocking one or more pins. Carefully clear the pins with metal tweezers. If necessary, clean the pins as described below.
 - If the pins appear OK, but the LED on the MagSafe connector does not light up, clean the pins as directed in Kbase article 303240: Use and cleaning of power adapter with MagSafe connector.
4. Remove the battery and connect the power adapter. If the adapter turns on and boots the system, replace the logic board.

Sound

No sound is audible but the Speakers section of the Sound system preference pane indicates an external device is plugged in (to the headphone jack or USB port)

1. If no device is connected to the headphone jack or USB port, set the Output tab of the Sound preference pane to Internal Speaker. If that doesn't resolve the issue, try connecting headphones or external speakers. Restart the computer and remove the device.
2. Reset PRAM. (After restart, hold down the Command-Option-P-R keys until you hear the startup chime at least one additional time after the initial startup chime).
3. If the system continues to indicate a phantom device is plugged into the system, replace the port hatch.
4. Replace the speaker assembly.
5. Replace the logic board.

No sound from speaker

1. Use Software Update to verify that the latest audio update has been installed.
2. Press the F10 key (using the fn key as a modifier if necessary) to verify that mute mode is not enabled.
3. Press the F11 or F12 key (using the fn key as a modifier if necessary) to check the volume setting.
4. Verify that no external speakers or headphones are plugged in.
5. Check the speakers tab on the Sound control panel to confirm that the software is correctly detecting that there are no external speakers or headphones connected. If so, use the previous troubleshooting procedure.

-
6. Shut down the computer and restart.
 7. Reset PRAM. (After restart, hold down the Command-Option-P-R keys until you hear the startup chime at least one additional time after the initial startup chime).
 8. Verify that the speaker cable is properly connected to the audio board under its housing.
 9. Check the speaker cable. Verify cable connections.
 10. Verify sound output with known-good headphones or external speakers. If audio is heard, replace the speaker assembly.
 11. Replace the logic board.

Distorted sound from speaker

Note: MacBook Air has a mono speaker. Its slim enclosure also does not have any speaker grilles. Because of this configuration, sound reverberates inside the enclosure and may be distorted at high volumes. If sound isn't distorted at normal volumes, there may not be a hardware failure.

1. Compare the same sound and same settings with two different units to make sure that sound is actually distorted. If abnormal, replace the speaker assembly.
2. Check the speaker cable. If damaged, replace the speaker assembly.
3. Replace the logic board.

Headphone jack

Poor audio (intermittent or “whiny” audio), through only one channel, or no audio at all

1. Plug in a pair of known-good iPod/iPhone headphones and compare sound quality. If audio quality improves, replace the original headphones.
2. If both headphones have poor audio quality, plug the known-good headphones into a second Macintosh and test them using the same or equivalent sound source (iTunes, song file, etc.). If the audio quality improves, the culprit may be the physical plug on the output device displaying symptoms.

Though the headphones or other appear to be fully plugged in, the jack may slightly touch the MacBook Air enclosure. This pressure can be enough to keep the jack from being full seated. The solution is to use an audio extender like the one suggested for iPhone.

Trackpad

Note: The MacBook Air trackpad introduces three new application-specific tracking gestures: pinch, rotate, and swipe. These are in addition to the standard point, scroll, tap, double-tap, and drag gestures. See the “Basics—General Information” section for more information.

The cursor does not move when you are using the trackpad

1. Verify that no USB device is connected.

-
2. Start up from a known-good Mac OS X system, such as the MacBook Air Software Install and Restore DVD, to verify that the issue is not software-related. If the trackpad works, restore the system software.
 3. Reset the SMC (power manager) as described in “Resetting the System Management Controller (SMC)” under “Troubleshooting Tips and Tricks” in the previous chapter.
 4. Check the IPD flex cable connection to the logic board.
 5. Replace the top case.
 6. Replace the logic board.

The cursor intermittently stalls or moves erratically

Note: When running Apple Hardware Test or Apple Service Diagnostic, the trackpad responds in very small movements of the cursor. This behavior is normal.

1. Clean the trackpad surface (with the computer off) using a static-free, soft cloth.
2. Shut down the system, then press the power button to start the computer.
3. Reset the SMC (power manager) as described in “Resetting the System Management Controller (SMC)” under “Troubleshooting Tips and Tricks” in the previous section.
4. Make sure the power adapter is connected to a known-good outlet using the AC power cord, not the adapter plug. If the intermittent behavior goes away, recommend using the AC cord to provide a grounding path for static.
5. Disconnect the power adapter, and run on battery power only. If the symptom goes away, replace the power adapter.
6. Start up from a known-good Mac OS X system, such as the MacBook Air Software Install and Restore DVD. Check the cursor movement, to see if the issue is software-related.
7. Check the IPD flex cable connection to the logic board.
8. Replace the top case.
9. Replace the logic board.

Video

No video, but computer appears to operate correctly

See section under the Startup section at the beginning of this chapter.

Dim display, but computer appears to operate correctly

1. Remove any connected peripherals.
2. Make sure the F1 key is not stuck down.
3. Press the F2 key (with the fn key pressed and not pressed) to increase the screen brightness.

-
4. Open Display system preference panel and check the brightness. If you can change the brightness setting using software, check the keyboard for keys that are stuck down. If a keycap is damaged, you may be able to replace just a keycap rather than the entire top case. Refer to the Additional Procedures chapter to identify the keyboard on the top case and verify whether or not to replace a keycap.
 5. If the keyboard is malfunctioning beyond just keycap damage, replace the top case.
 6. Reset PRAM. (After restart, hold down the Command-Option-P-R keys until you hear the startup chime at least one additional time after the initial startup chime).
 7. Try connecting an external display to check for intact video signal. If no external video appears, skip to step 9 below. Otherwise proceed to next step.
 8. Verify that the LVDS cable connector is seated properly and the cable is not damaged.
 9. Replace logic board.
 10. Replace the display assembly.

Computer appears to work, but there is no video on an external device connected to the Micro DVI to Video Adapter

1. The device must be connected to the Micro DVI port while the MacBook Air is sleeping or off for the device to be recognized.
2. Verify that the test monitor being used is a known-good device supported by this computer.
3. Try a different Micro DVI-to-Video Adapter.
4. Check port hatch flex cable connection to the logic board.
5. Replace the port hatch assembly.
6. Replace the logic board.

Display has repetitive patterns or shifting color pattern

1. Check for the latest system software update.
2. Check that the LVDS connection is fully seated on the logic board.
3. Connect an external display. If the external video displays the mirrored image correctly, replace the display assembly.
4. Replace the logic board.

Display has permanent vertical or horizontal lines.

1. Check for the latest System software update.
2. Connect an external display. If the external video displays the mirrored image correctly, replace the display assembly.
3. Check that the LVDS connection is fully seated on the logic board.
4. Replace the logic board.

Miscellaneous Symptoms

The Date and Time settings reset repeatedly

Note: Resetting the SMC and/or PRAM resets the date and time. The MacBook Air does NOT have a backup battery.

Replace the logic board.

Feet came off the bottom case

Replace the bottom case.

Sleep Indicator Light does not come on when display is closed

1. Put the computer to sleep using the menu option. If the sleep indicator light goes on, the computer is not detecting a closed display.
2. Replace the logic board.
3. Replace the top case.
4. Replace the display.

Unit unusually hot

The normal operating temperature is well within national and international safety standards. Still, customers may be concerned about the unit overheating. To prevent an unneeded repair, you can compare a customer's computer to a running model, if available, at your repair site.

1. Verify that the customer uses the computer while it is placed on a flat, hard surface.
2. Verify that the computer is hotter than expected for normal operation. If possible, compare how hot the computer case feels with how hot the case of a running display model feels.
3. If the computer is running at a temperature comparable to the test model, refer the customer Knowledge Base article 30612: Apple Notebooks: Operating Temperature
4. Use Activity Monitor to check for runaway applications.
5. Check the processor speed. The operating system automatically reduces the processor speed if the computer gets too hot.
6. Listen for the fan running. If the unit feels too hot and you do not hear a fan running or cannot feel the air venting over the top of the keyboard or under the bottom case, the fan may have failed. Proceed to the Take Apart procedure for replacing the thermal module.
7. Check for misplaced or inadequate thermal paste. See the "Thermal Module" section of the Take Apart chapter for complete details.

For more information on the operating temperature of Apple portable computers, see Knowledge Base article 30612: Apple Notebooks: Operating Temperature.

Software Sluggish Due to Excessive Warmth

Software (especially video games or other graphics-intensive software) may operate sluggishly when the MacBook Air is very warm.

This is expected behavior. MacBook Air uses built-in graphics circuitry to provide video output to the built-in and/or external displays. The operating system automatically reduces the processor speed if the computer starts to get too hot. This will correspondingly reduce the graphics performance of all running applications.

Refer to Knowledge Base article 307297: MacBook Air: 3D Graphics applications less responsive when CPU is hot



Block Diagram

A simplified block diagram of the North Bridge, South Bridge, and buses that connect them:

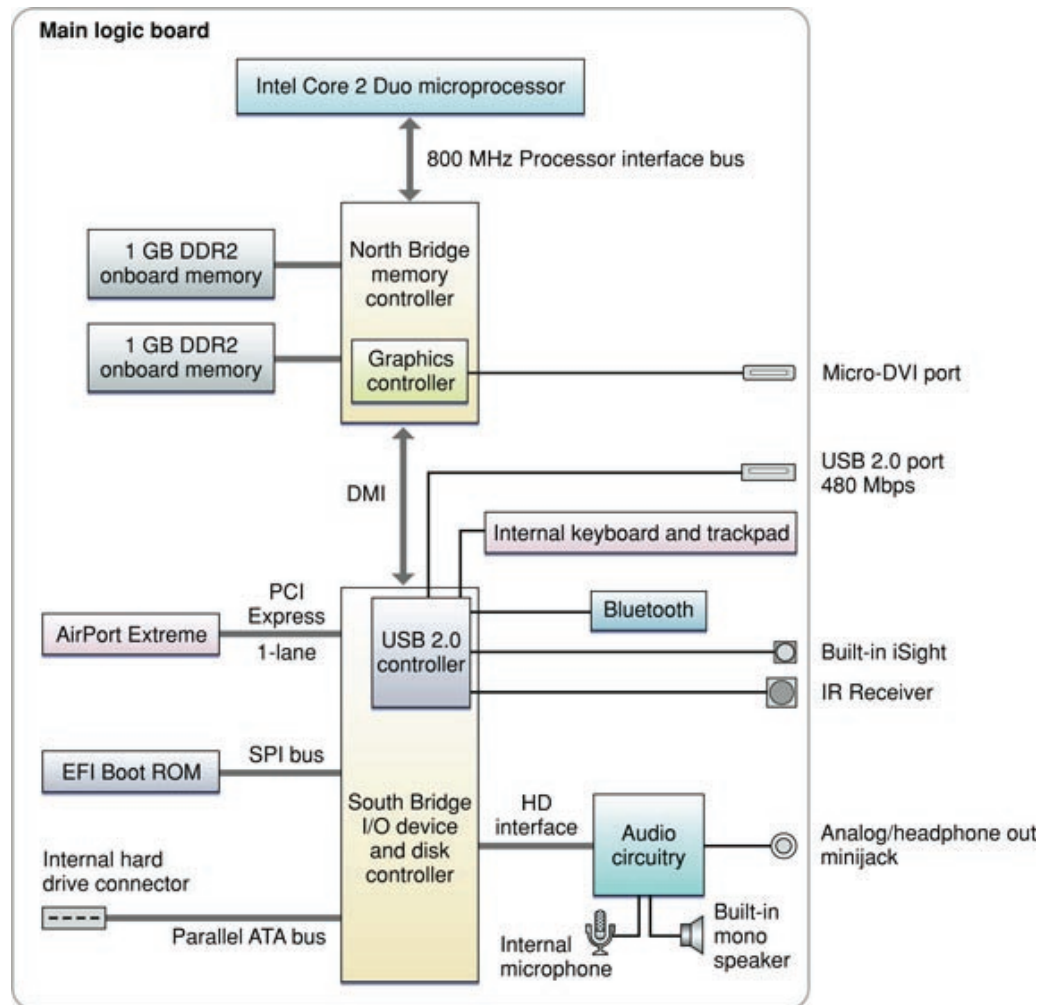

The architecture of the MacBook Air is based on the Intel Core 2 Duo microprocessor and two ICs, the North Bridge memory controller and the South Bridge I/O controller, connected to each other by a Direct Media Interface (DMI) bus. The North Bridge provides the bridging functionality among the processor, the memory system, and the DMI.

The South Bridge supports these components:

- Parallel ATA (PATA) bus for the hard drive or the optional solid state drive
- 1-lane PCI Express link for the AirPort Extreme module

-
- SPI bus, direct memory access bus to the boot ROM
 - USB 2.0 controller, which in turn supports the Bluetooth 2.1 + EDR module, built-in iSight camera, built-in trackpad and keyboard, and one external, high-powered USB 2.0 port
 - Channel to the audio subsystem

A DMA controller internal to the South Bridge supports LPC DMA (low pin count direct memory access). The DMA controller has registers that are fixed in the lower 64 KB of I/O space. The DMA controller is configured using registers in the PCI configuration space.

Using the block diagram to help with troubleshooting

Study the block diagram to understand...

- which I/O controllers have a direct connection to their external ports
- which I/O controllers have an I/O device controller between them and external ports

For example, let's say that you are troubleshooting an AirPort connectivity symptom. Input to the Airport/Bluetooth Card comes from the logic board. Power and addressing to the card are necessary for its operation.

Microwave data output signal to the antenna is also necessary for the card's operation. Therefore, you have three components to check to discover faulty AirPort operation—logic board, Airport/Bluetooth Card, and antenna.

If installing a known-good Airport/Bluetooth Card restores operation, you need to focus on the original card. If the known-good card does not restore operation, you need to focus on the logic board or the original antenna cable assembly.

Observing the block diagram, you can see that the Airport Extreme signal is on a PCI Express bus. System Profiler is a good tool to verify I/O. If you can see both the known-good Airport/Bluetooth Card and original Airport/Bluetooth Card in System Profiler, suspect the antenna.

For more information

See the MacBook Air Developer Notes for more information: http://developer.apple.com/documentation/HardwareDrivers/Conceptual/MacBookAir_0801/Introduction/Introduction.html.

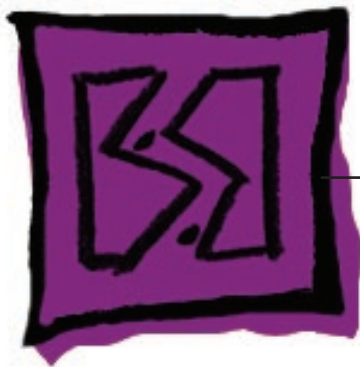

Views

MacBook Air



Exploded Views

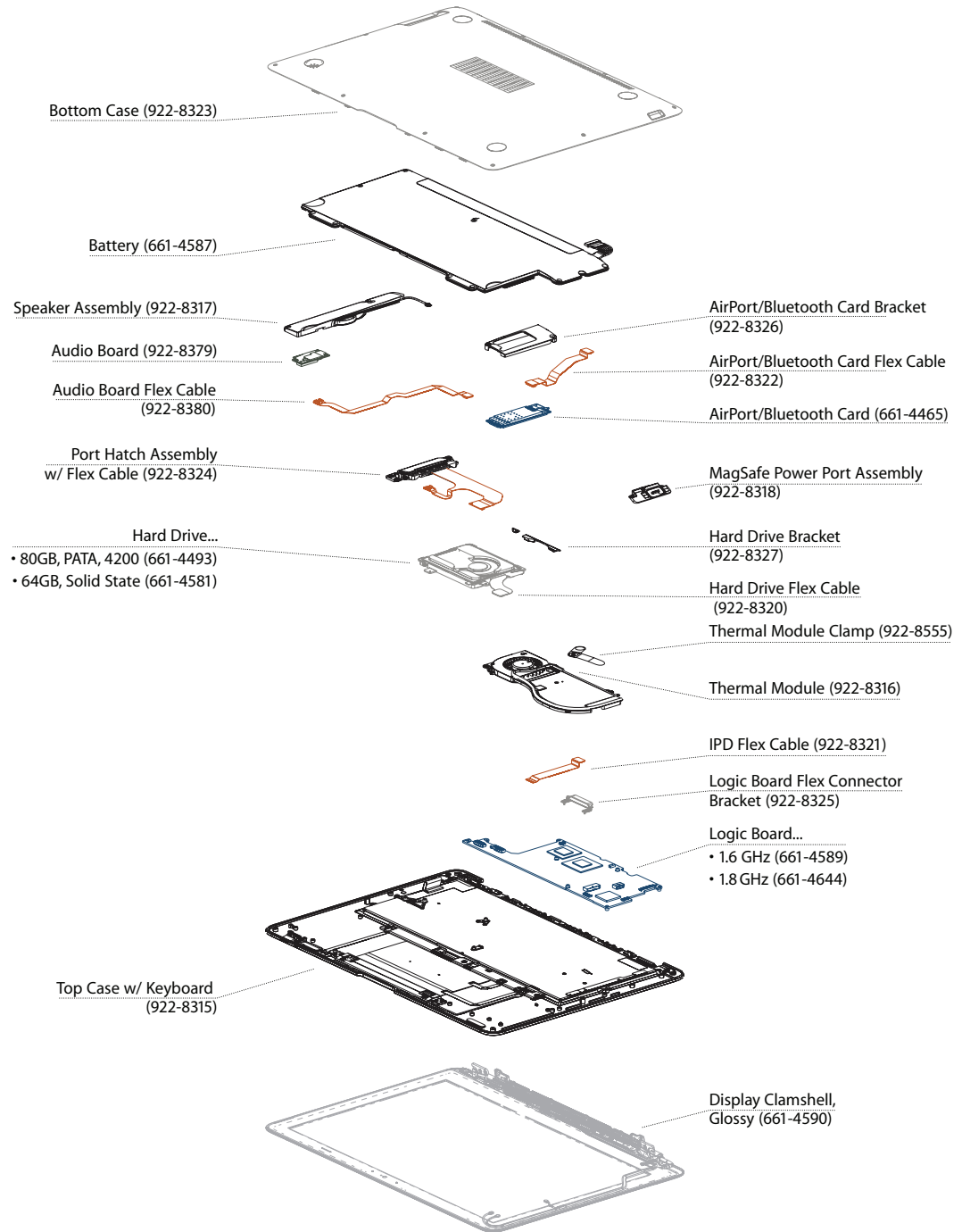



Screw Maps

Because of the MacBook Air's contoured shape, many components use screws of multiple size and length. Replacing even identically-sized screws in their original locations, especially on the bottom case, ensures the easiest and most intact reassembly.

The screw maps on the following pages (thumbnails below) can be printed on magnetic-backed inkjet paper to allow for precise screw storage and reference during take-apart procedures. (All screws in the MacBook Air contain ferrous material and should adhere to magnetic material.)

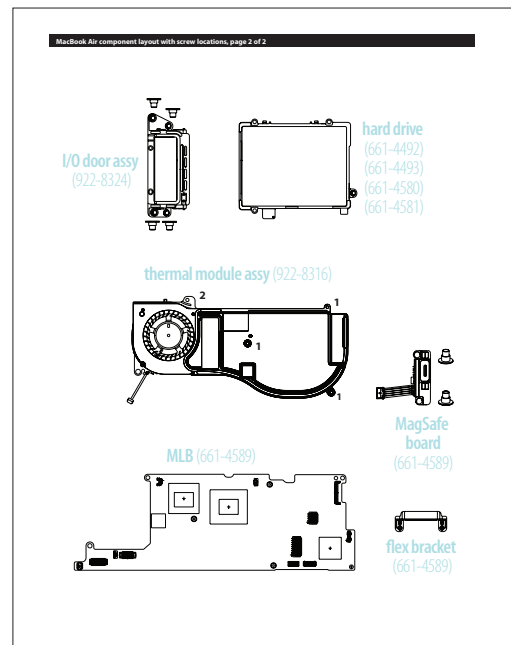
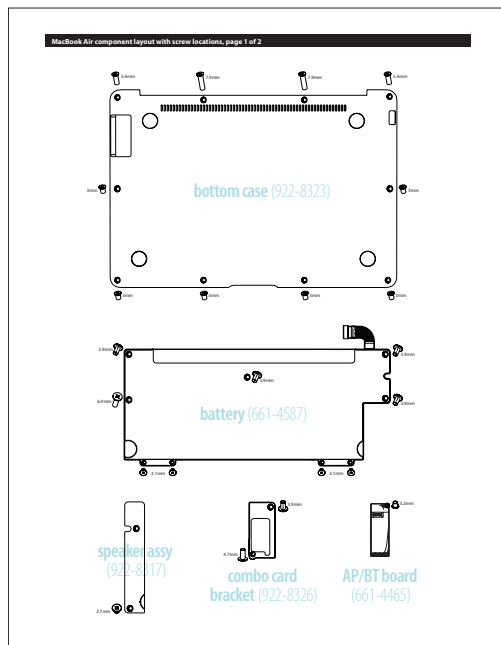

Note that because the polarity of the magnetic material faces away from the printed surface, you will need to place two sheets back to back to provide adequate attraction for the screws. However, only the top surface needs the printed image. During disassembly, be sure to lay the sheets in a protected area on a flat surface.

Click on the following link for an example of a product which works for this purpose:

<http://www.staples.com/webapp/wcs/stores/servlet/StaplesProductDisplay?&langId=-1&storeId=10001&catalogId=10051&productId=141359&cmArea=SEARCH>

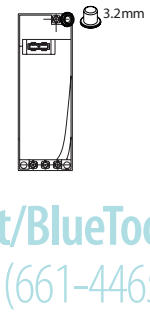
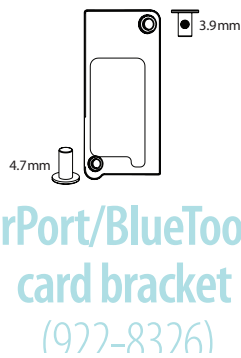
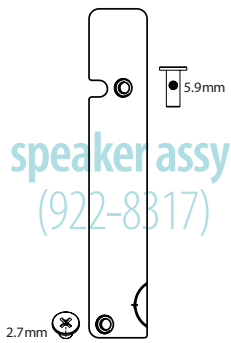
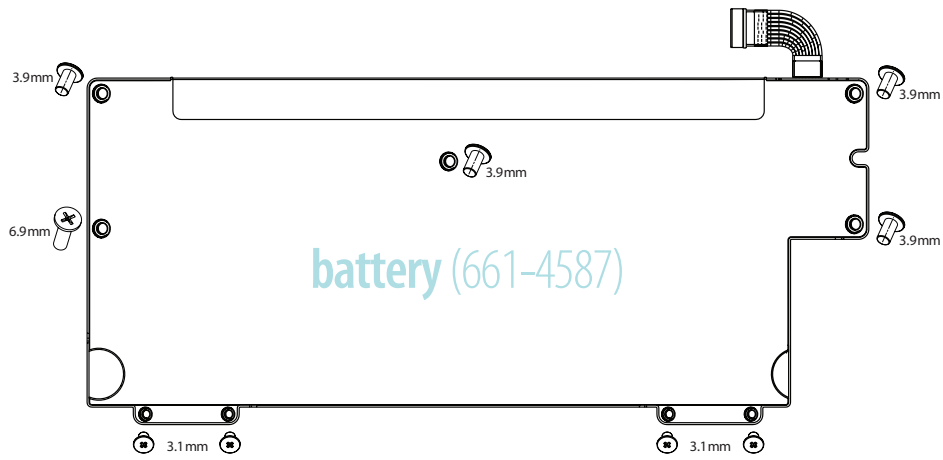
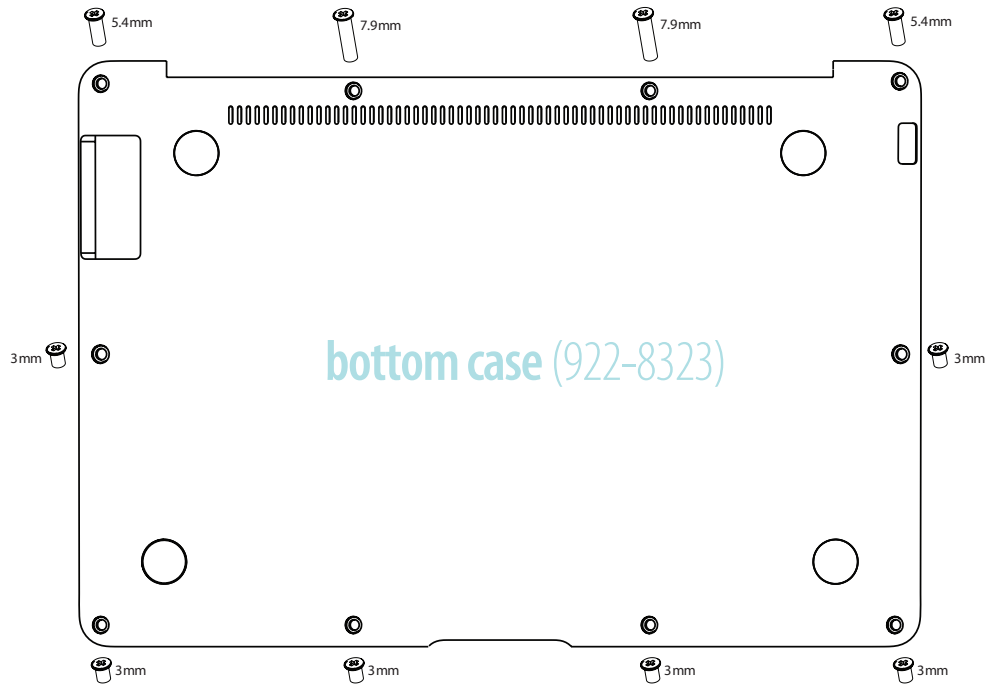

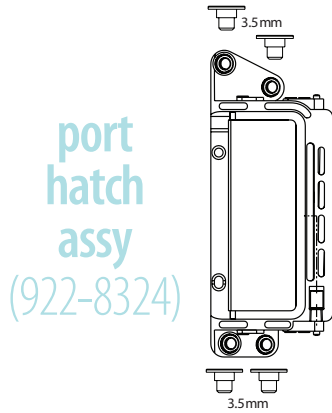

port hatch
assy
(922-8324)

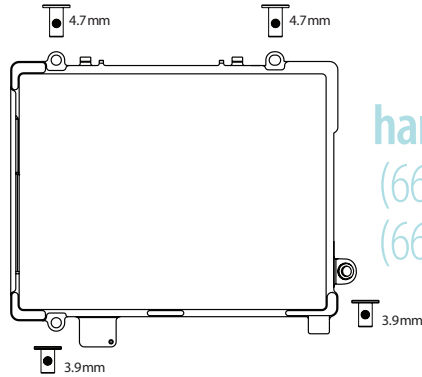

hard drive
(661-4493)
(661-4581)

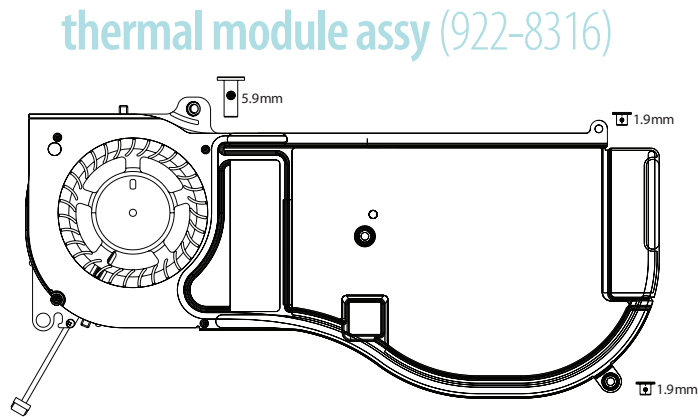

thermal module assy (922-8316)

thermal module clamp
(boomerang, 922-8316)

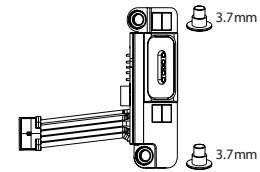
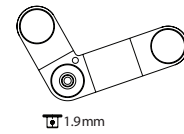

MagSafe
assembly
(922-8318)

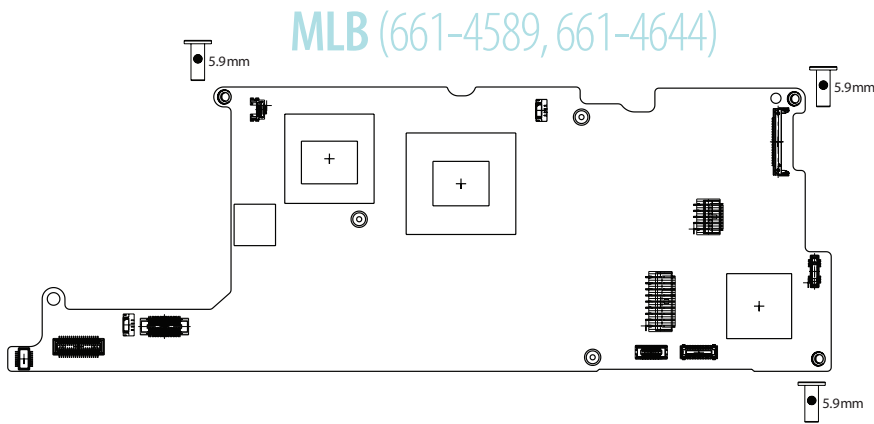

MLB (661-4589, 661-4644)

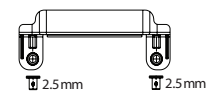

flex bracket
(922-8325)