

Apple Service Source

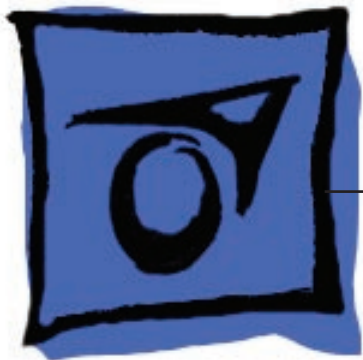

Mac Pro

Updated: 4 March 2008

Mac Pro

Contents

Basics

Overview 6

Serial Number Location 7

Take Apart

General Information 9

Opening the Computer 10

Hard Drives 12

Optical Drive Carrier and Optical Drives 15

Memory (FB-DIMMs) and Memory Riser Cards 19

PCI Express/Graphics Card 23

Power Supply 29

Power Supply Fan 38

AirPort Extreme Card 47

Bluetooth Card 50

Battery 52

Processor Heatsink Cover 54

Front Fan Assembly 59

Mac Pro RAID Card & Battery 62

Processor Heatsinks 68

Memory Cage with Rear Fan 73

Processors 76

Speaker Assembly	83
USB Cable	87
Logic Board	90
Front Panel Board	100
Power Button	105
AirPort Antenna Board with Cables	110
Optical Drive Power Cable	114
Optical Drive Data (Ribbon) Cable	117
Ambient Board	120
Ambient Board Cable	122
Bluetooth Antenna Board and Cable	124
Hard Drive Cable Harness	127
Hard Drive Temperature Sensor Cable	130
Hard Drive Temperature Sensor	133
Power Cable Harness	136

Troubleshooting

General Information	140
Memory	140
PCI Express Cards	141
Internal Cabling Matrix	141
Thermal Calibration	143
Block Diagram	144
Resetting the Logic Board	145
Power-On Self Test: RAM and Processor Verification	146
Diagnostic LEDs	147
Power Supply Verification	152
Mac Pro Firmware Updates	152
Symptom Charts	154
How to Use the Symptom Charts	154
Startup Failures	154
Fans	157
Other Failures	158

Upgrades

AirPort Extreme Card 162

Bluetooth Card 165

PCI Express/Graphics Card 167

Views

Exploded View 172

External Views 174

Screw Matrix 176

Service Source



Basics

Mac Pro



Overview

The Mac Pro form factor is similar to that of earlier Power Mac G5 models. However, the Mac Pro includes several new hardware features, including:

- Two dual-core Intel processors
All Mac Pro models have two dual-core Intel Xeon processors, effectively making them quad processor computers.
- FB-DIMM memory supporting ECC and up to 16 GB of RAM
Higher performance memory with support for error correction and greater capacity means more room to grow when using high-performance computing applications.
- Four internal hard drives
Mac Pro supports up to four serial ATA (SATA) hard drives in easy-to-install drive carriers.
- Two optical drives
Mac Pro offers support for two cable-select optical drives

In addition to the features above, Mac Pro includes logic board diagnostic LEDs that help you better diagnose hardware issues.





Serial Number Location

To identify a particular Mac Pro computer, check the computer's serial number. You can find the serial number within the model's configuration label, which is located on the computer's back panel directly below the video ports.



Apple Service Source



Take Apart
Mac Pro



General Information

Orientation

For most take-apart procedures, it is recommended that you lay the computer on its side before removing or installing the part. For proper operation, however, Apple recommends that the unit be run in the upright position. The computer should never be operated on its side with the access panel facing down.

Tools

The following tools are required to service all configurations of the computer:

- Long-handled magnetized Phillips #1 screwdriver
- Long-handled magnetized 3 mm flathead hex screwdriver
- Short-handled, magnetized 2.5 mm hex wrench
- Flat-blade screwdriver
- Magnetized jewelers Phillips #1 screwdriver
- Magnetized jeweler's Phillips #0 screwdriver
- Jeweler's flat-blade screwdriver
- Socket wrench
- Apple Mac Pro wrench (part number 922-8025)
- Needlenose pliers
- Scissors or wire cutters
- Xacto knife
- Nylon probe tool (black stick)
- Tape (for temporarily holding cables out of the way)
- Small mirror (for seeing small boards inside the enclosure)
- Soft cloth (for protecting the enclosure from scratches)

Parts Requiring Enclosure Replacement

The following are not separate, orderable parts. To replace them, you must replace the enclosure.

- Media shelf
- Rear panel latch



Opening the Computer

Tools

No tools are required for this procedure.

Preliminary Steps

1. Shut down the computer.
Warning: Always shut down the computer before opening it to avoid damaging its internal components or the components you are installing. Do not open the computer or attempt to install items inside it while it is on.
2. Wait 5 to 10 minutes to allow the computer's internal components to cool.
Warning: After you shut down the system, the internal components can be very hot. You must let the computer cool down before continuing.
3. Unplug all external cables from the computer except the power cord.
4. Touch the metal PCI access covers on the back of the computer to discharge any static electricity from your body.
Important: Always discharge static before you touch any parts or install any components inside the computer. To avoid generating static electricity, do not walk around the room until you have finished working and closed the computer.
5. Unplug the power cord.
Warning: To avoid damaging its internal components or the components you want to install, always unplug the computer before attempting any take-apart procedure.
6. Put on an ESD wrist strap.

Procedure

1. Hold the side access panel and lift the latch on the back of the computer.
Warning: The edges of the access panel and the enclosure can be sharp. Be very careful when handling them.
2. Remove the access panel and place it on a flat surface covered by a soft, clean cloth.
Replacement Note: Make sure the latch is in the up position before replacing the access panel. If the latch is down, the access panel will not seat correctly in the enclosure.

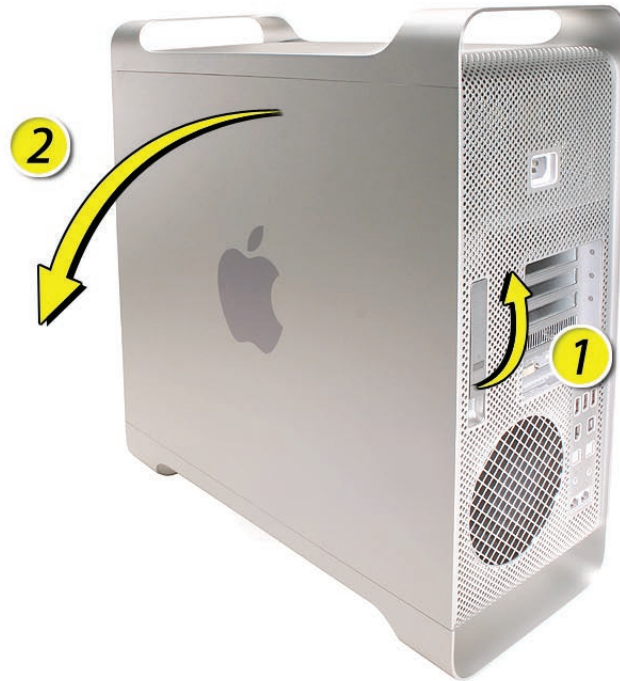



Hard Drives

The Mac Pro computer can accommodate four serial ATA (SATA) 3 Gbps hard drives in its four internal hard drive bays. In most configurations, a single hard drive occupies the far left bay (bay 1).

The hard drives must meet the following specifications:

- Type: SATA 3 Gbps
- Width: 3.9 inches (102 mm)
- Depth: 5.7 inches (147 mm)
- Height: 1.0 inch

Tools

The only tool required for this procedure is a Phillips #1 screwdriver.

Preliminary Steps

Before you begin, open the computer, and lay it on its side with the access side facing up.

Important: Make sure the latch on the back panel is in the up position. When the latch is down, the hard drives and carriers are locked in place and you will not be able to remove them.

Part Location

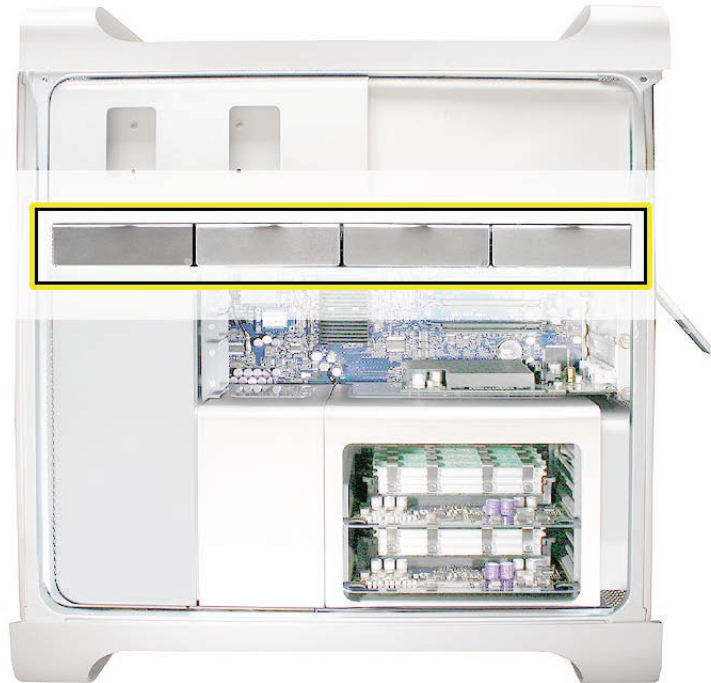

Procedure

1. Make sure the latch on the back panel is up, so that the drives and carriers are unlocked.
2. Pull the hard drive out of the drive bay.

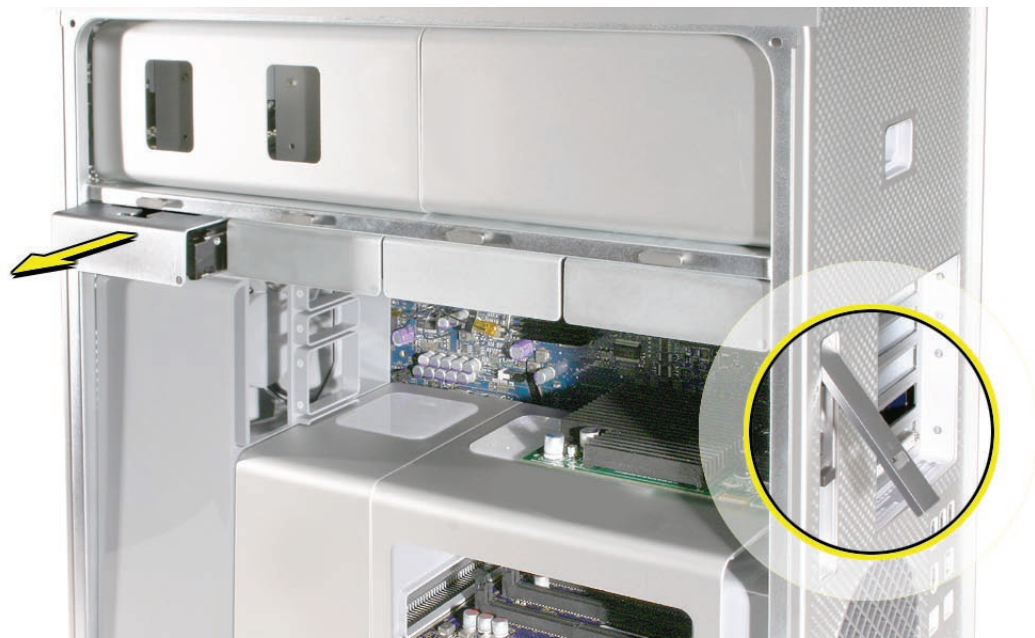

-
3. If you are replacing the hard drive with a new drive, remove the four screws that mount the drive to the carrier and mount the new drive in the carrier.

Important: Hold the drive by its sides. Be careful not to touch the printed circuit board on the bottom of the drive.



Replacement Note: Slide the carrier and drive over the guides and into the drive bay, until you feel the drive snap into place.

Note: If you install a new (replacement) drive, format it by following these steps:

1. Open Disk Utility and select the drive in the list to the left.
Note: If you are formatting the primary drive, use the Disk Utility program on the Install Disk.
2. Click on the Partition tab.
3. Click on “Options” and verify GUID is selected if this is a bootable drive.
4. Apply the change by clicking on the “Partition” button.



Optical Drive Carrier and Optical Drives

The Mac Pro computer can accommodate two optical drives in the optical drive bay. If the computer has only one optical drive, it is installed in the top position.

Note: To eject the drives, use the following:

- Top drive: Press the Eject key.
- Bottom drive: Press the Option and Eject keys.

Tools

The only tool required for this procedure is a Phillips #1 screwdriver.

Preliminary Steps

Before you begin, open the computer, and lay it on its side with the access side facing up.

Important: Make sure the latch on the back panel is in the up position. When the latch is down, the optical drives and carrier are locked in place and you will not be able to remove them.

Part Location

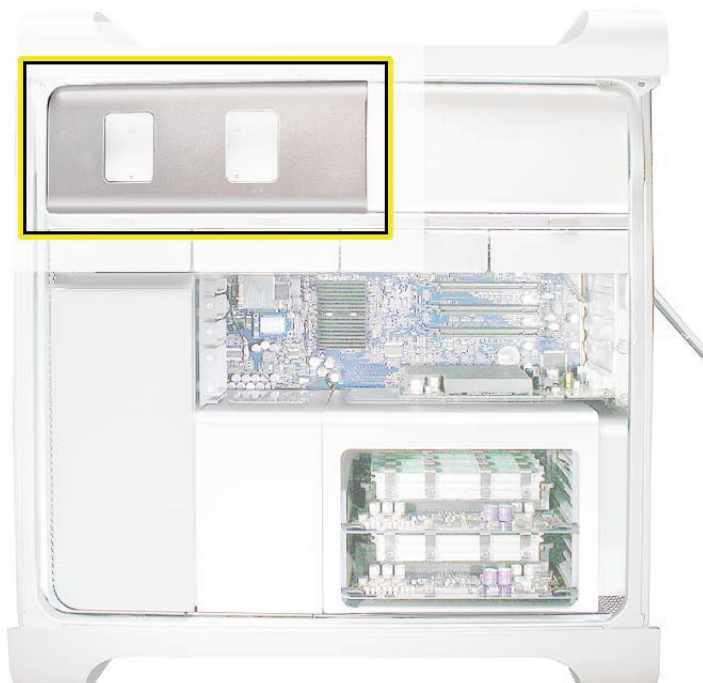

Procedure

Removing the Optical Drive Carrier and Optical Drives

1. Make sure the latch on the back panel is up, so that the drives and carriers are unlocked.

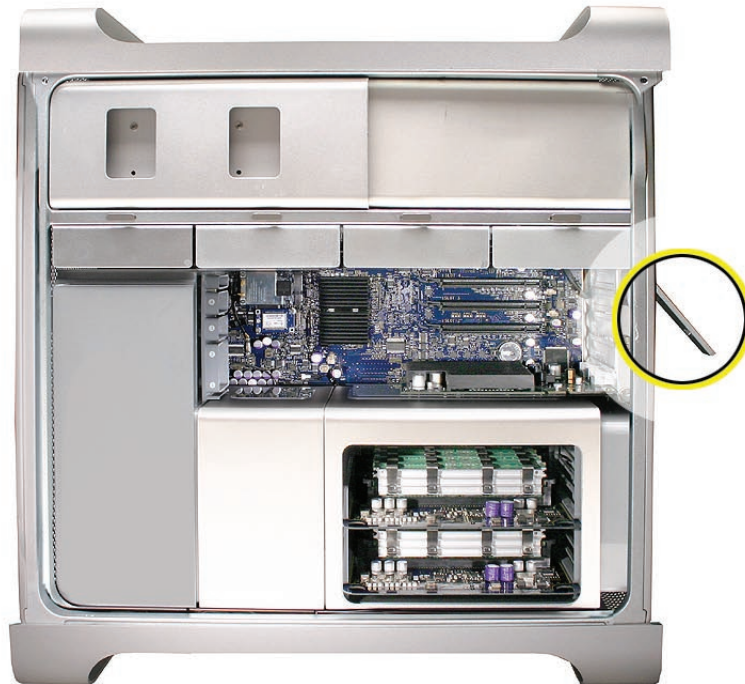

2. Pull the optical drive carrier part way out of the computer.



3. Disconnect the power and ribbon cables from the optical drive(s) and remove the carrier.

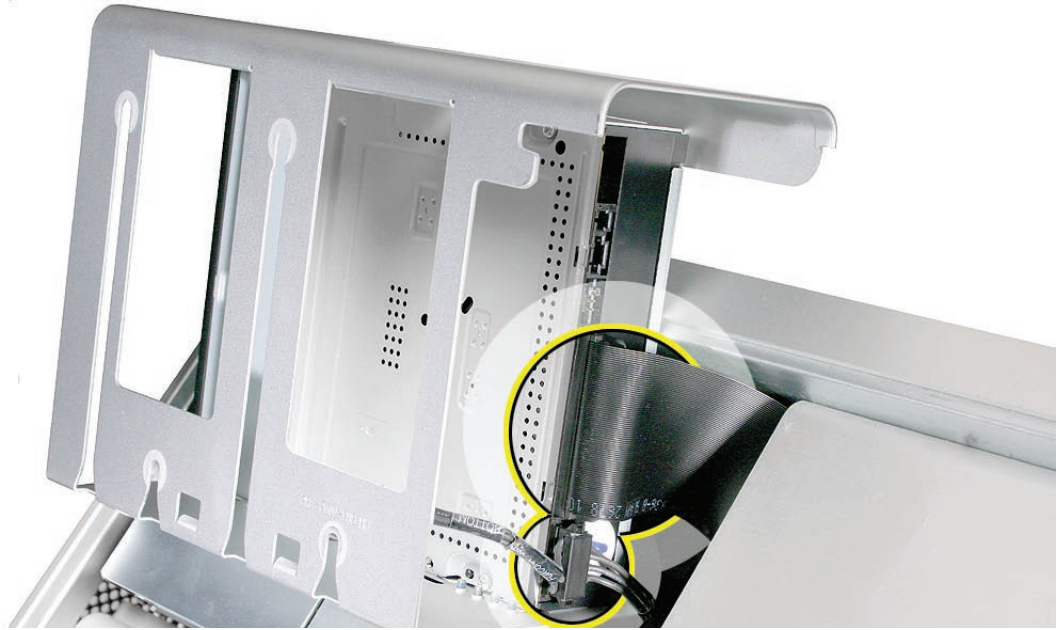

4. If you are replacing the optical drive with a new optical drive, do the following:
 - Remove the four mounting screws and remove the optical drive from the carrier.
 - Use the four screws to mount the replacement drive in the carrier.

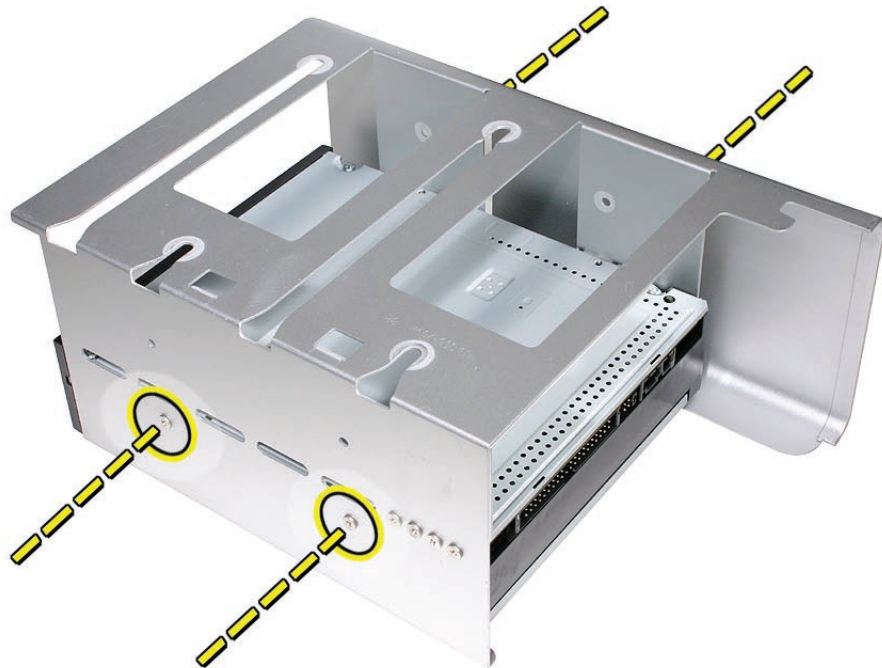

Note: If you are adding a second drive to the carrier, use the four screws stored on the back of the drive carrier to secure the drive to the carrier.

Replacing the Optical Drive Carrier and Optical Drives

Important: Use the original Apple cables that came with the computer when you install or replace the optical drives. If just one optical drive is installed, tuck the cables for the second drive out of the way.

1. Attach the power and ribbon cables to the back of the drive(s).

Important: Attach the connector on the end of the optical drive ribbon cable and the connector in the middle of the optical drive power cable to the top drive. If there is a second drive in the carrier, attach the remaining optical drive ribbon and power connectors to the bottom drive.



2. Slide the optical drive carrier over the guides and into place in the optical drive bay.



Memory (FB-DIMMs) and Memory Riser Cards

The Mac Pro computer has two memory riser cards with a total of 8 memory slots. On each card, the slots are arranged as two banks of two slots each. The computer comes with a minimum of 1 GB of memory, installed as a pair of 512 MB fully buffered, dual inline memory modules (FB-DIMMs) in two of the DIMM slots. Additional DIMMs can be installed in the open DIMM slots, as illustrated below.

Note: DIMMs must be installed in pairs of equal size from the same vendor. In the illustration below, DIMMs in one colored pair do not need to match DIMMs in a different colored pair.

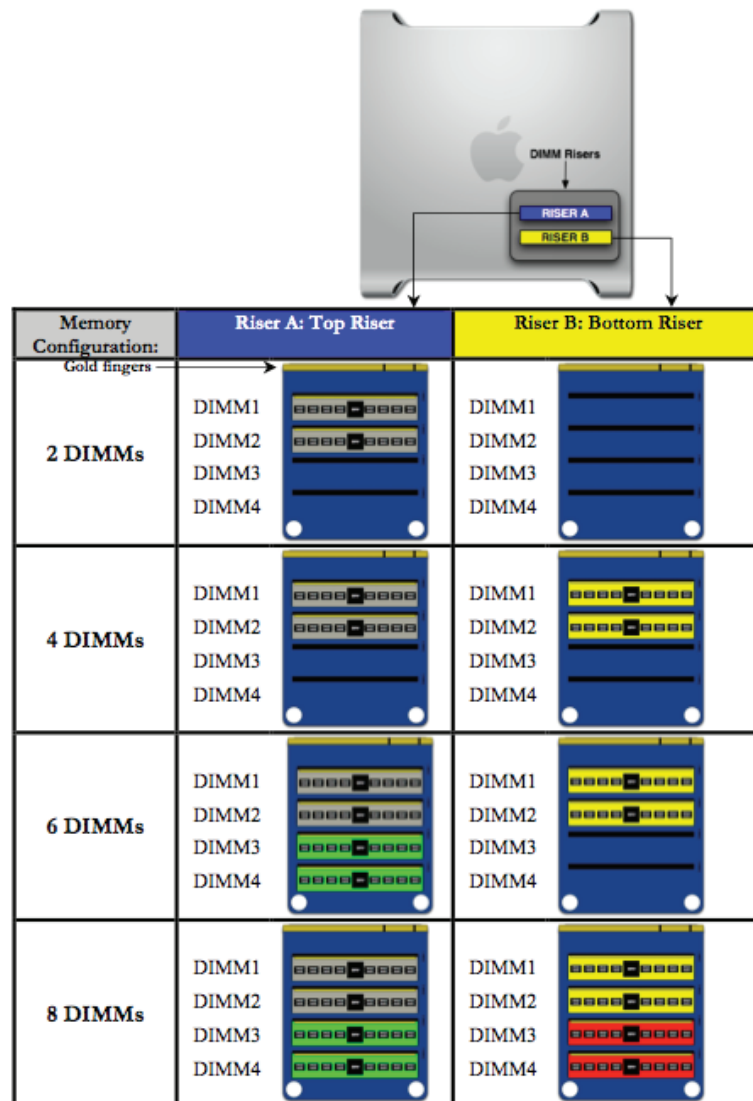

DIMMs for Mac Pro must fit these specifications:

- 667 MHz, FB-DIMMs
- 72-bit wide, 240-pin modules
- 36 devices maximum per DIMM
- Error-correcting code (ECC)

Memory from older Macintosh computers is not compatible with Mac Pro.

Important: For proper operation of Mac Pro computers, Apple recommends using only Apple-approved Mac Pro FB-DIMMs. Refer to GSX for Apple FB-DIMMs service part numbers.

Tools

No tools are required for this procedure.

Preliminary Steps

Before you begin, open the computer, and lay it on its side with the access side facing up.

Warning: Always wait 5–10 minutes for the computer to cool down before you remove or install memory. The DIMMs may be very hot.

Part Location

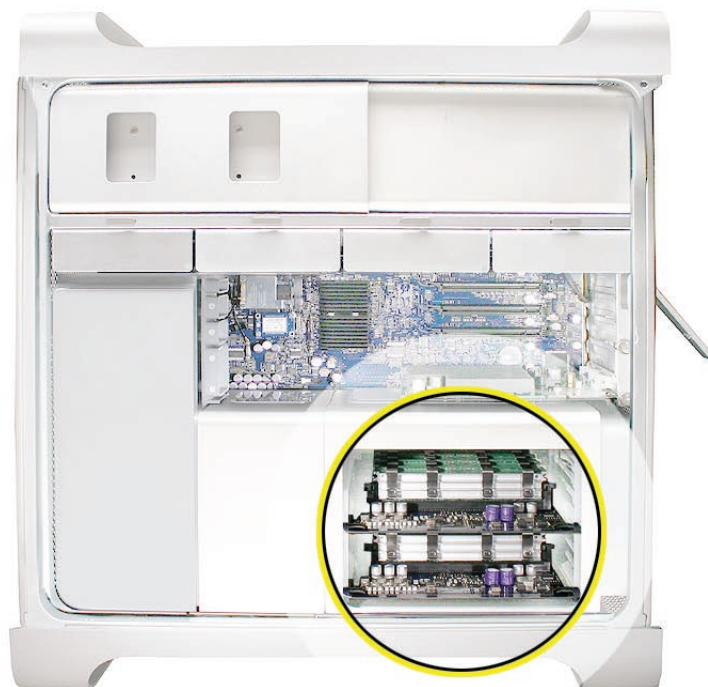

Procedure

1. Holding the memory riser card by the two finger holes, pull it out of the memory cage and place the card DIMM side up on a soft, clean cloth.

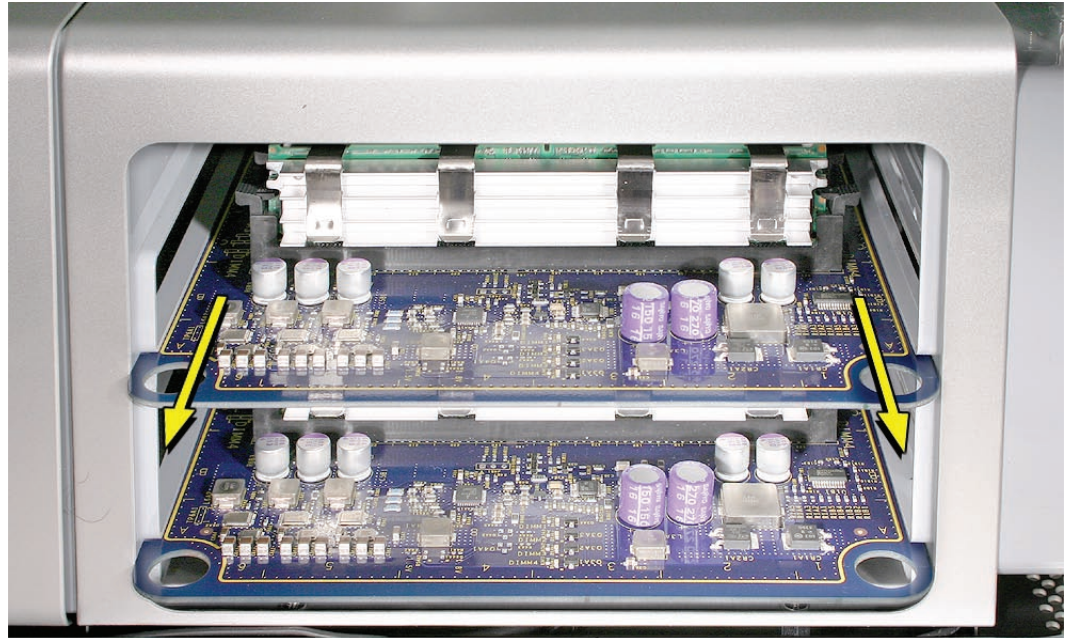

2. Open the ejectors on the DIMM slot by pushing them out to the sides, and remove the DIMM from the riser card.

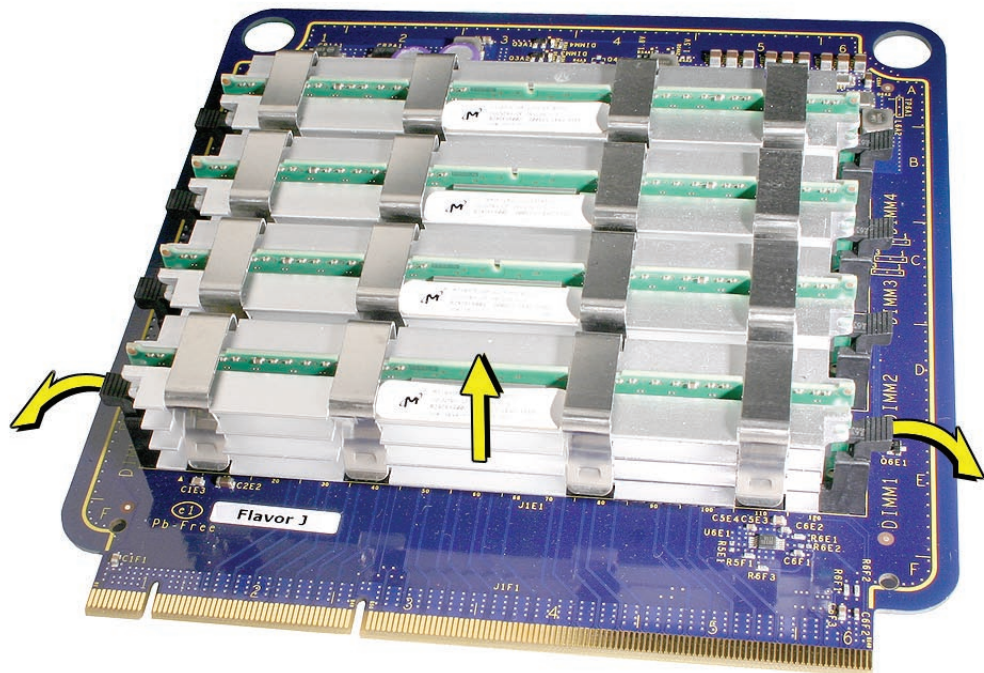

Replacement Note: Align the DIMM in the slot on the riser card and push both ends of the DIMM down until the ejectors snap back up into place.

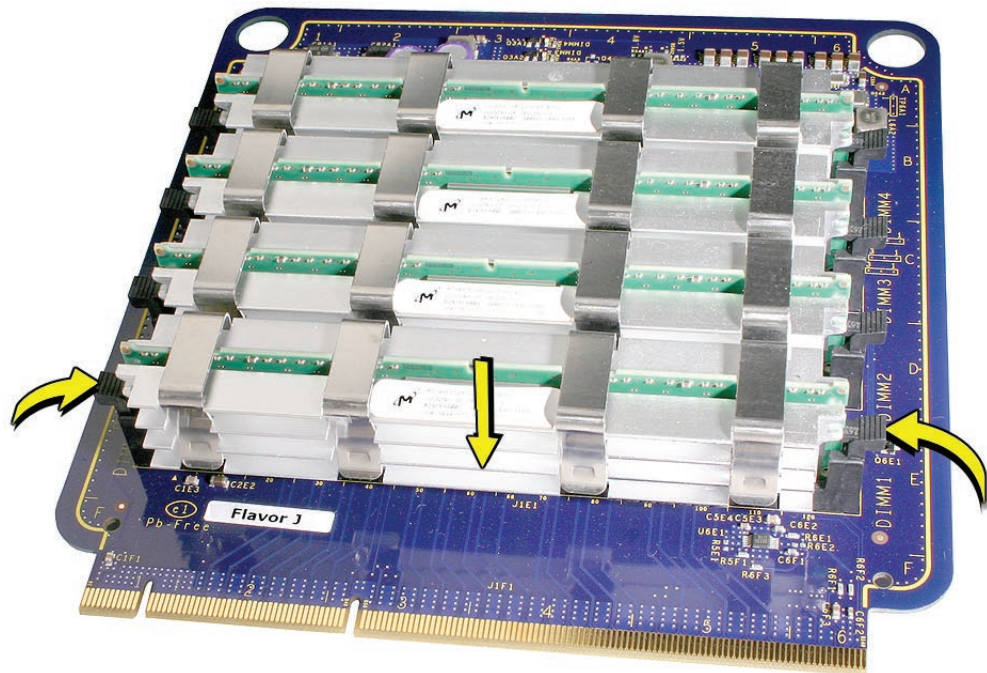

Warning: FB-DIMMs carry heatsinks on either side of the DIMM. Never attempt to remove the heatsinks from the DIMMs. Doing so could damage the DIMM.

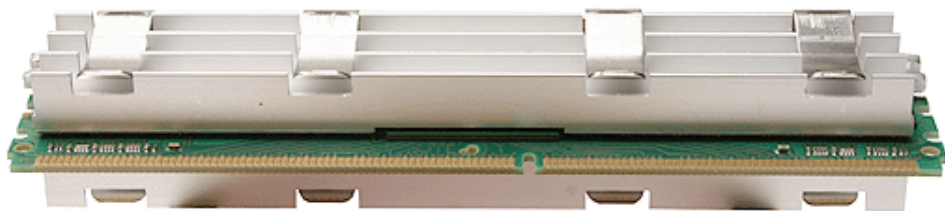



PCI Express/Graphics Card

The Mac Pro logic board includes one double-wide PCI Express graphics slot and three PCI Express expansion slots, for a total of four slots. The computer comes with a graphics card installed in slot 1. You can install additional PCI Express graphics and expansion cards in the remaining three PCI Express expansion slots.

Important: Graphics cards from previous Power Mac G5 models are not compatible with Mac Pro models. In addition, Mac Pro graphics cards are not compatible with Power Mac G5 models.

Important: Combined maximum power consumption for all four PCI Express slots must not exceed 300 W.

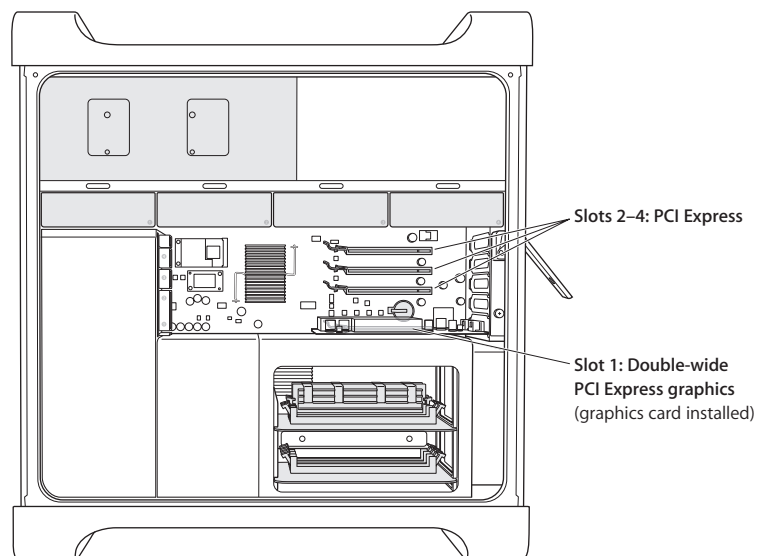

Note: Port 2 of the ATI Radeon X1900 XT graphics card is compatible with the Apple DVI-to-video adapter. See [KnowledgeBase article 304910](#).

Tools

The only tool required for this procedure is a Phillips #1 screwdriver.

Preliminary Steps

Before you begin, open the computer, and lay it on its side with the access side facing up.

Note: You may also find it helpful to remove the [hard drives and carriers](#) and any adjacent PCI Express cards before beginning this procedure.

Part Location

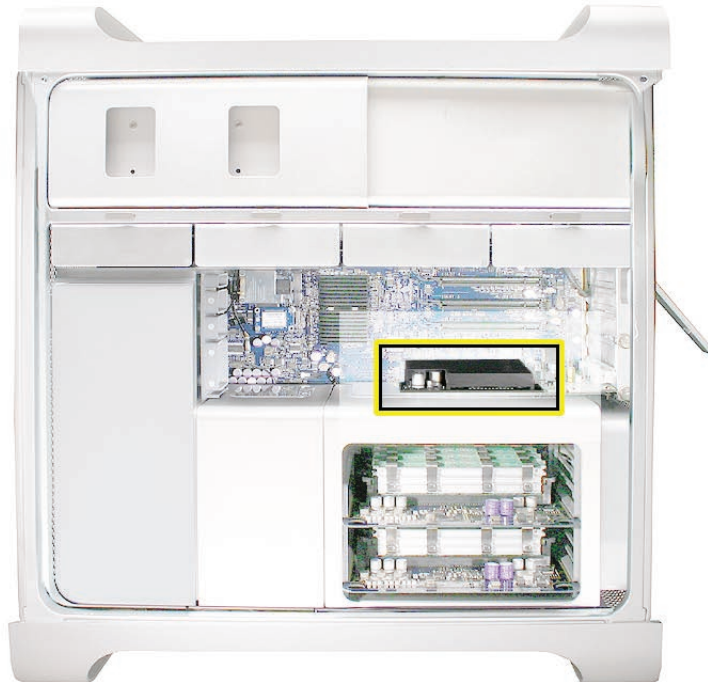

Procedure

This procedure explains how to remove a standard card and a card that includes a booster cable. Before you can remove either type of card, however, you must first loosen the two captive screws that secure the PCI bracket to the enclosure and remove the bracket.

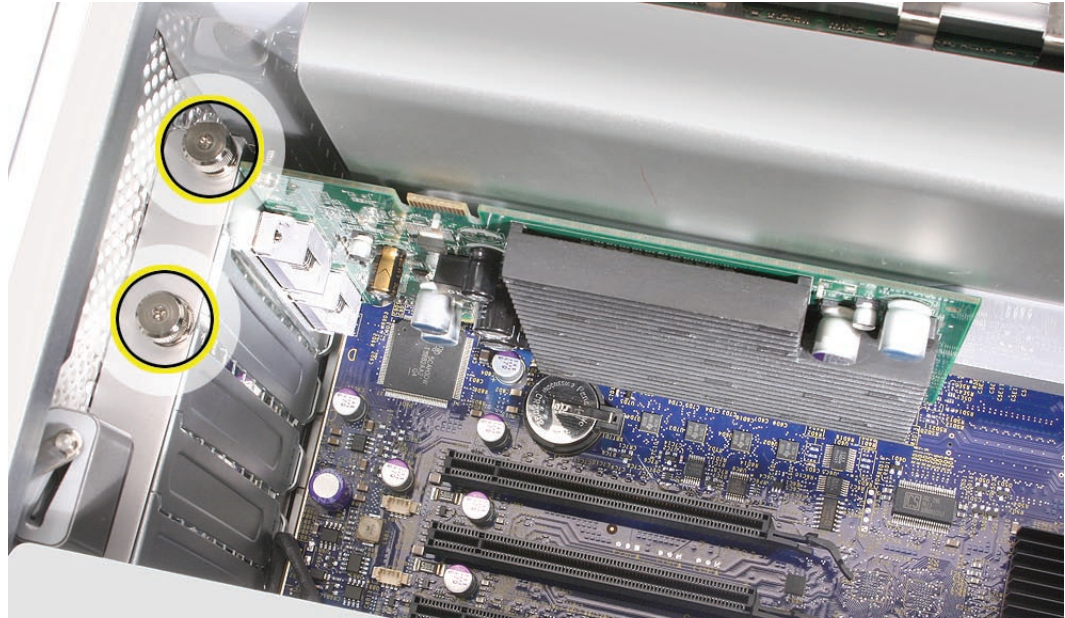

Warning: When removing or installing a card, handle it only by the edges. Do not touch its connectors or any of the components on the card. Lift the card straight out from the connector to remove it, and insert it straight into the connector to install it. Do not rock the card from side to side and don't force the card into the slot. Once the replacement card is installed, pull on it gently to check that it is properly connected.

Standard Card

1. Release the small locking clip at the front of the card's logic board connector by pushing the clip up toward the media shelf.
2. Holding the card by the top corners, pull up the card and remove it from its expansion slot.

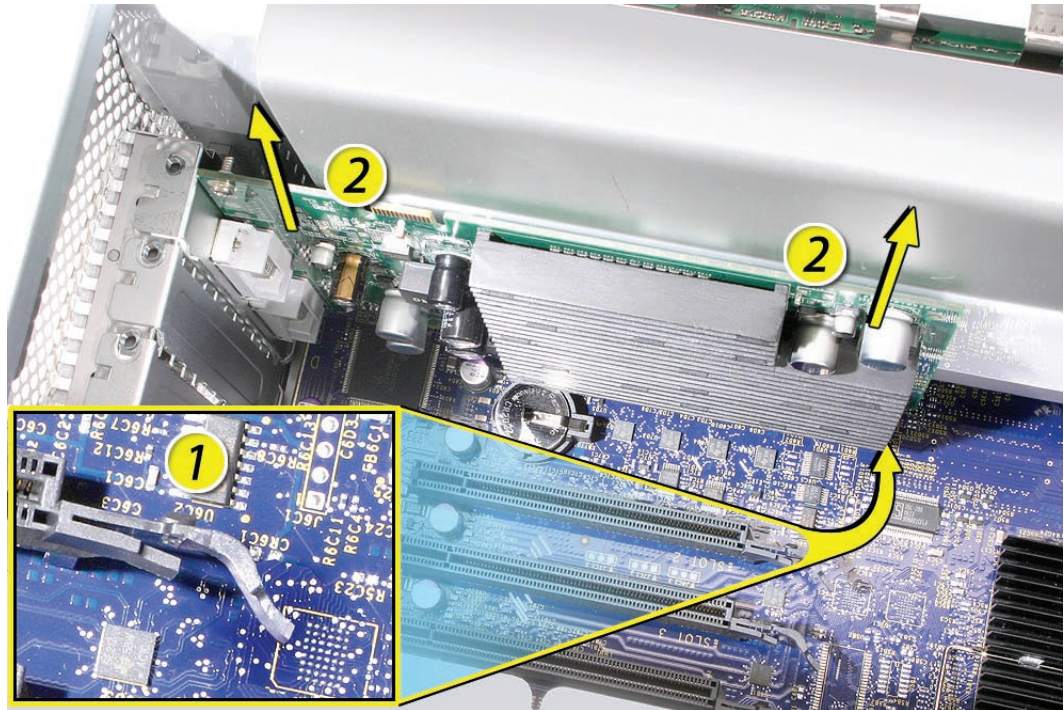

Replacement Note: Align the card's connector with the expansion slot and press until the connector is inserted all the way into the slot. If you're installing a 12-inch card, make sure the card engages the appropriate slot in the PCI card guide.

- Don't rock the card from side to side; instead, press the card straight into the slot.
- Don't force the card. If you meet a lot of resistance, pull the card out. Check the connector and the slot for damage or obstructions, then try inserting the card again.
- Pull the card gently to see if it is properly connected. If it resists and stays in place and its gold connectors are barely visible, the card is connected.

Card with Booster Cable

1. Disconnect the booster cable from the logic board.
2. Release the small locking clip at the front of the card's logic board connector by pushing the clip up toward the media shelf.
3. Holding the card by the top corners, gently pull up the card and remove it from its expansion slot.

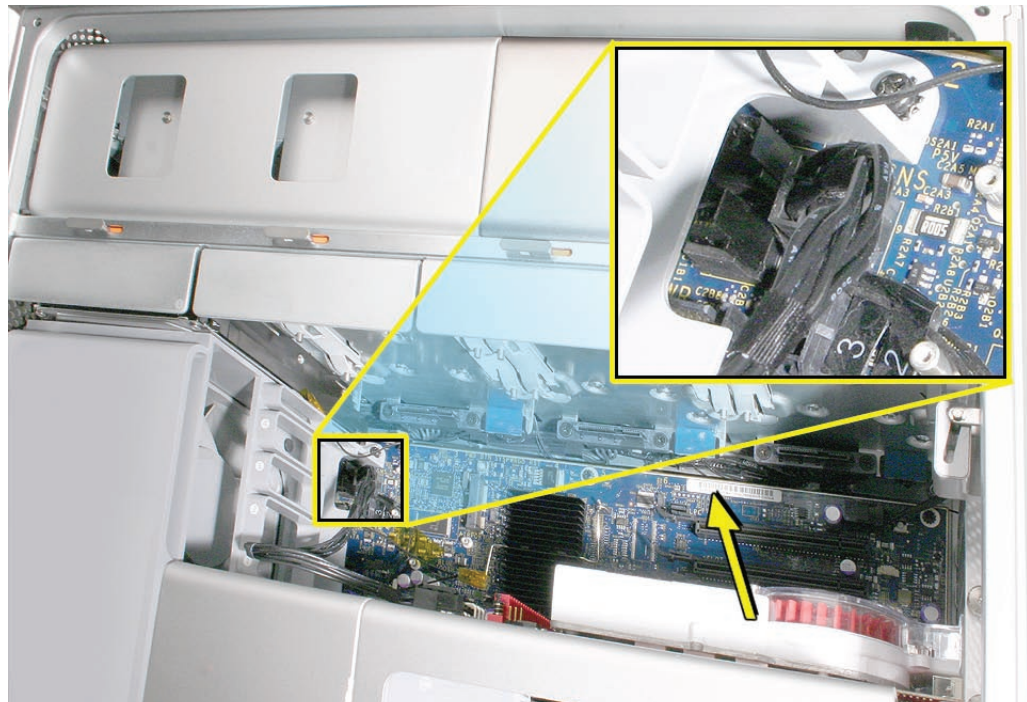

4. If you are replacing the booster cable with a new booster cable, disconnect the cable from the card.

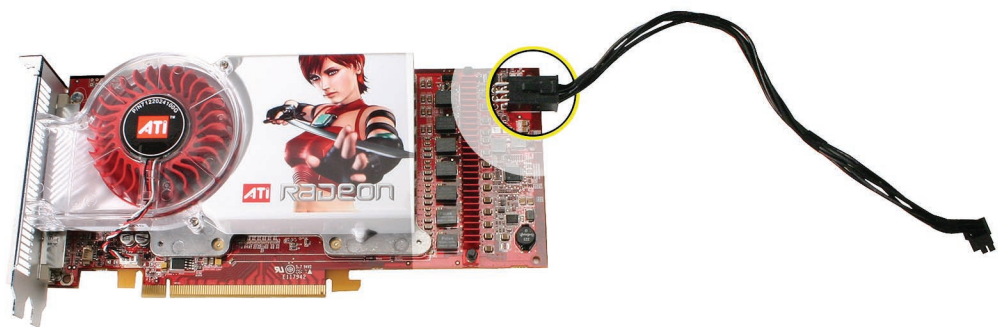

Replacement Note: There are two logic board connectors for booster cables. Connect the booster cable for a card in PCI slot 1 to the lower connector. Connect the booster cable for a card in PCI slot 2 to the upper connector.

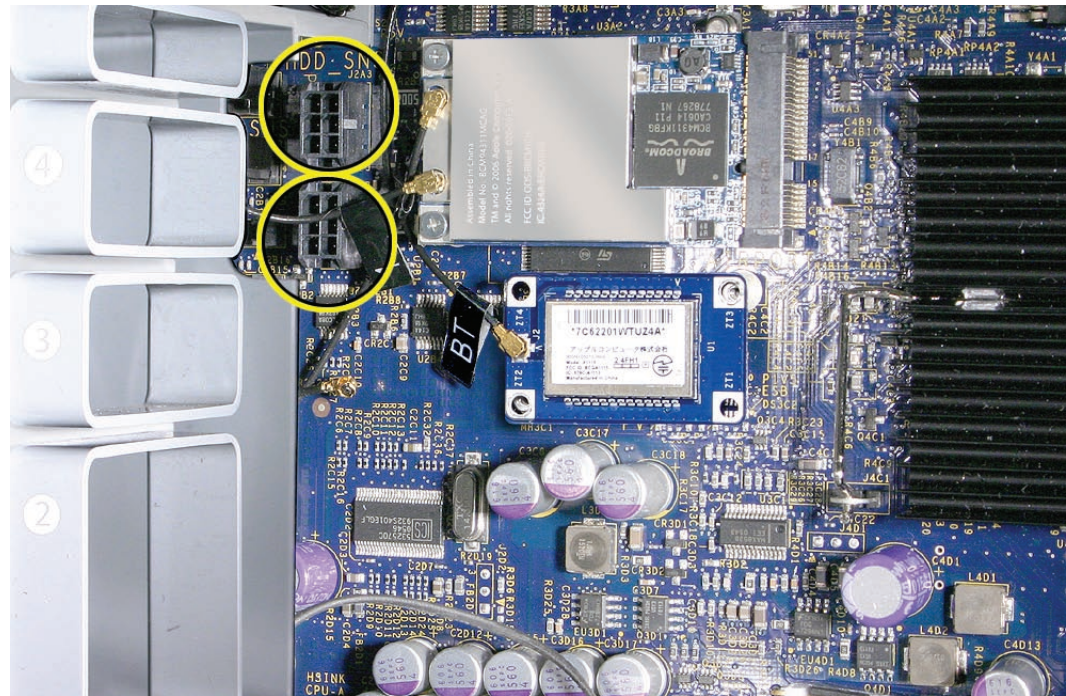



Power Supply

Tools

The only tool required for this procedure is a magnetized 2.5 mm hex wrench. You may also find a flat-blade screwdriver helpful in releasing some cable connectors.

Preliminary Steps

Before you begin, open the computer, lay it on its side with the access side facing up, and remove the following:

- [Hard drives and hard drive carriers in drive bays 3 and 4](#)
- [Optical drive carrier and optical drives](#)
- [Any PCI Express cards that block access to the power supply mounting screws](#)

Part Location



Procedure

Removing the Power Supply

1. Using a magnetized 2.5 mm hex wrench remove the four power supply mounting screws from the bottom of the media shelf.

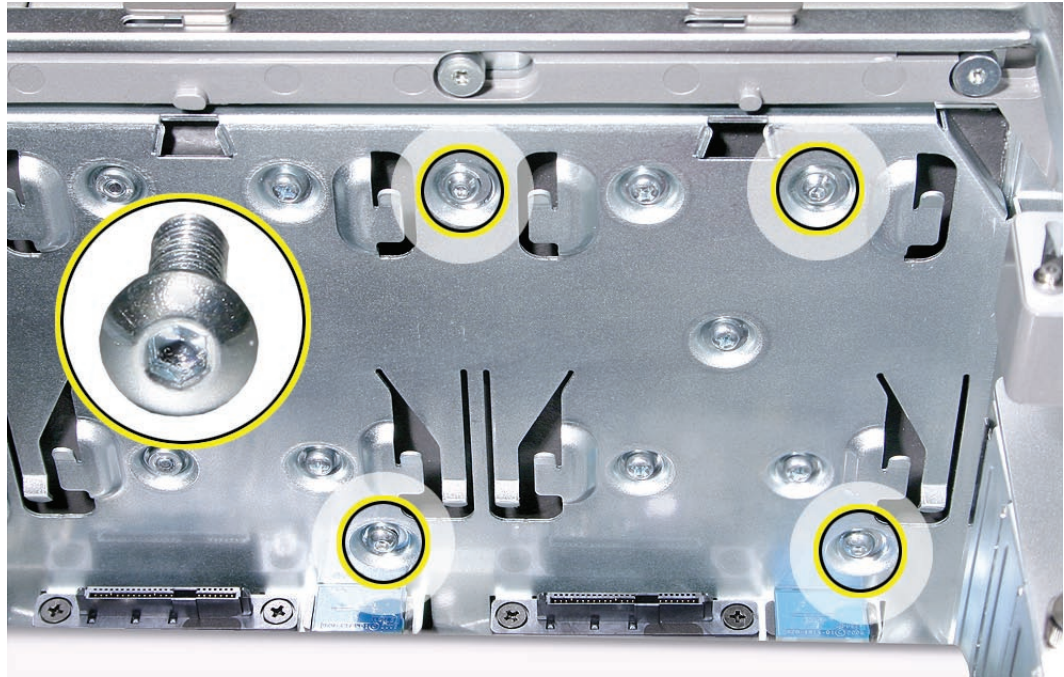

2. Depress the upper right corner of the power supply and slide the power supply toward the front of the computer.

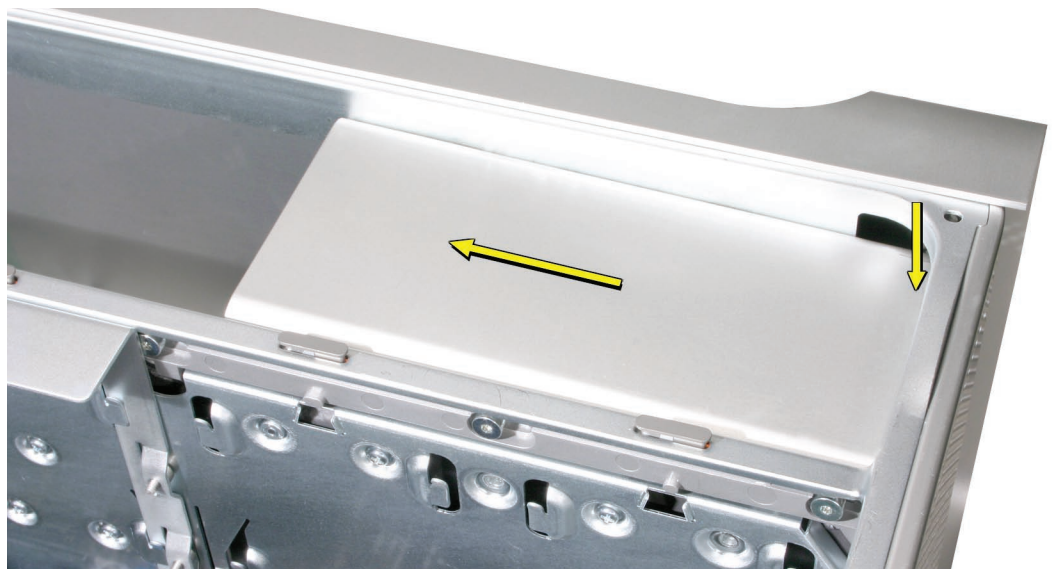

Note: Before beginning the next step, place a soft cloth over the edge of the enclosure to prevent scratches from the power supply.

3. Lift the power supply a short distance and rest it on the edge of the enclosure.



Note: The power supply is still connected to the enclosure by its cable. To remove the power supply entirely from the enclosure, you must disconnect the power supply cable's four connectors, which mate with four power harness connectors threaded through openings in the media shelf's vertical divider.

4. Starting with the top connector and working down, disconnect the four connectors on the power supply cable from the four connectors on the power harness cable.



Note: You must release the locking latch on each power supply cable connector before detaching the connector.

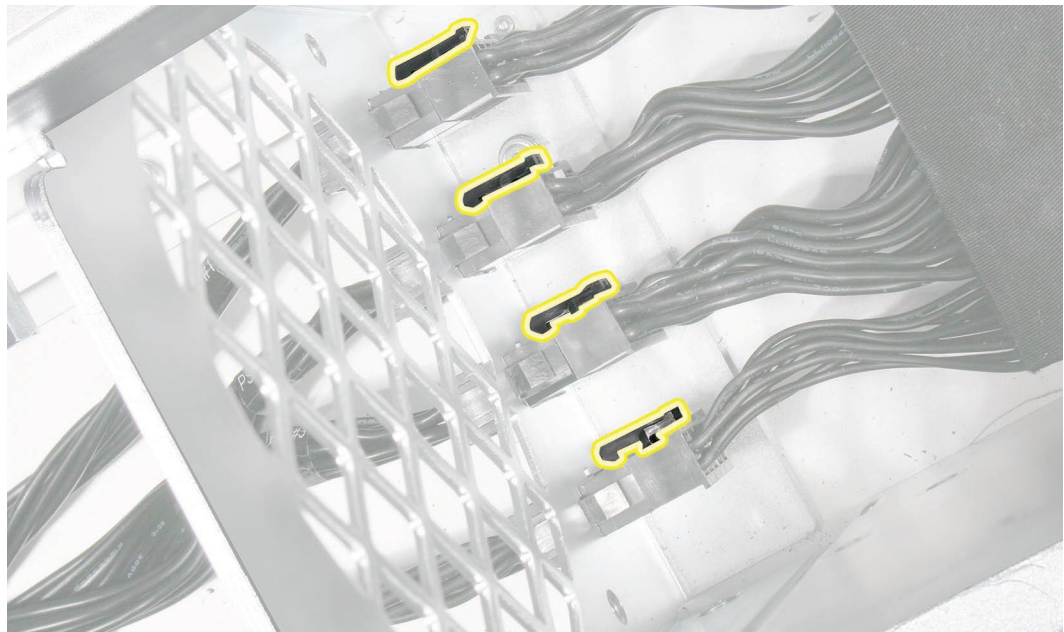

5. Remove the power supply from the enclosure.

Replacing the Power Supply

Note: To protect against scratches, make sure a soft cloth covers the edge of the enclosure next to the power supply bay.

1. Rest the power supply on the edge of the enclosure so that its cable can reach the media shelf divider.



Note: The following four steps explain how to reconnect the power supply cable connectors with the power harness connectors. When the power harness connectors are in their original position in the media shelf divider, it is not possible to see where they mate with the power supply cable connectors. Therefore, the next step shows how to temporarily remove the power harness connectors from the divider for a better line of sight.

2. Starting with the top connector and working down, release the four power harness cable connectors from their openings in the media shelf divider.

Note: Each connector has two locking latches that hold it to the divider. To release the connector, depress the bottom latch first and then the top latch. You may find a flat-blade screwdriver useful in depressing the latches.

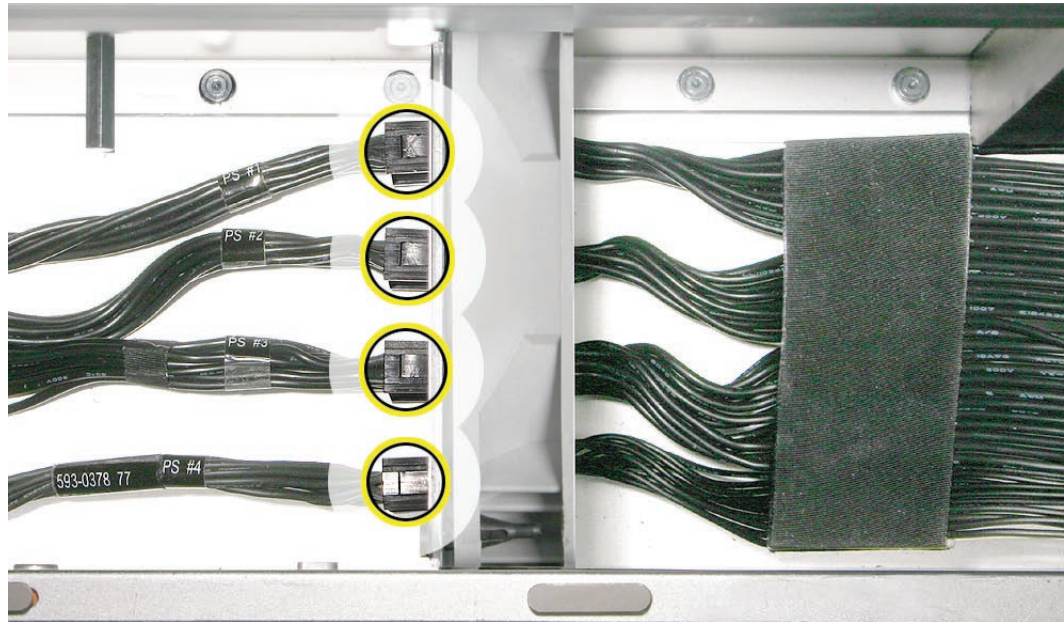

3. Placing a hand on either side of the media shelf divider, thread the J1 connector on the power supply cable through the top connector opening in the media shelf divider and connect it to the PS1 connector on the power harness.



Repeat for the other three power supply cable connectors.

4. **Important:** The first three connectors on the power supply cable are marked J1, J2, and J3; the fourth connector is not marked. The four connectors on the power harness cable are marked PS1, PS2, PS3, and PS4. You must connect J1 to PS1, J2 to PS2, etc.



5. Starting at the bottom connector and working up, depress the locking latches on each power harness connector and reinsert it into its opening in the media shelf divider.



Important: Test that all power supply cable connectors and power harness connectors are fully seated by tugging on the cables on both sides of each of the four paired connectors.

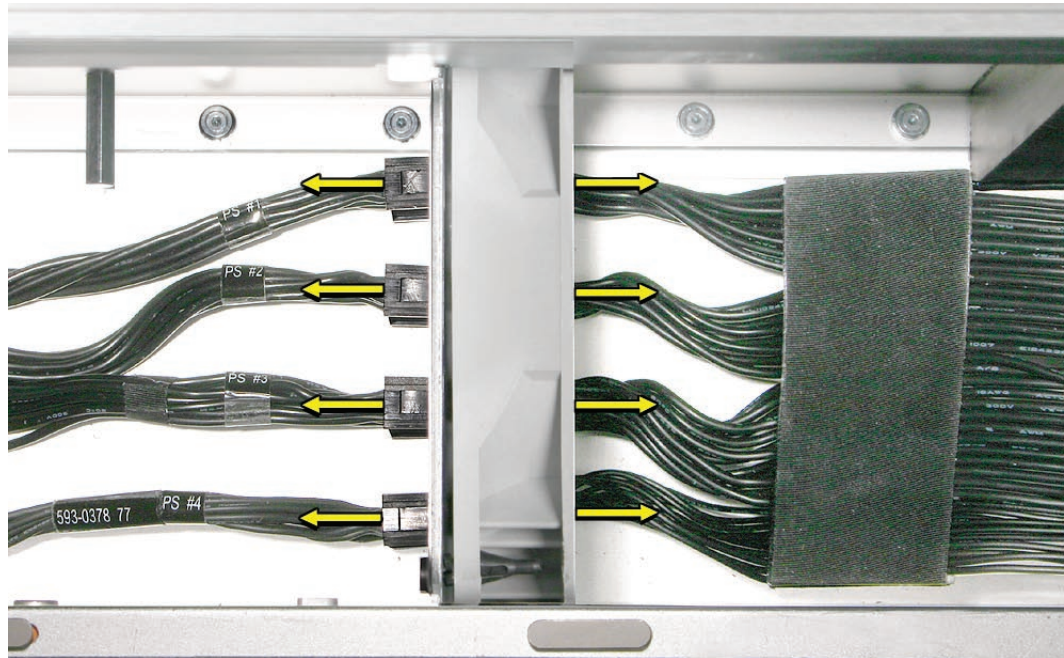

6. Fold the power supply cable on the bottom of the power supply bay.
7. Lift the power supply and remove the soft cloth from the edge of the enclosure.
8. Holding the power supply at an angle, as illustrated, lower it into the enclosure until its upper right corner slides under the corner lip of the enclosure.

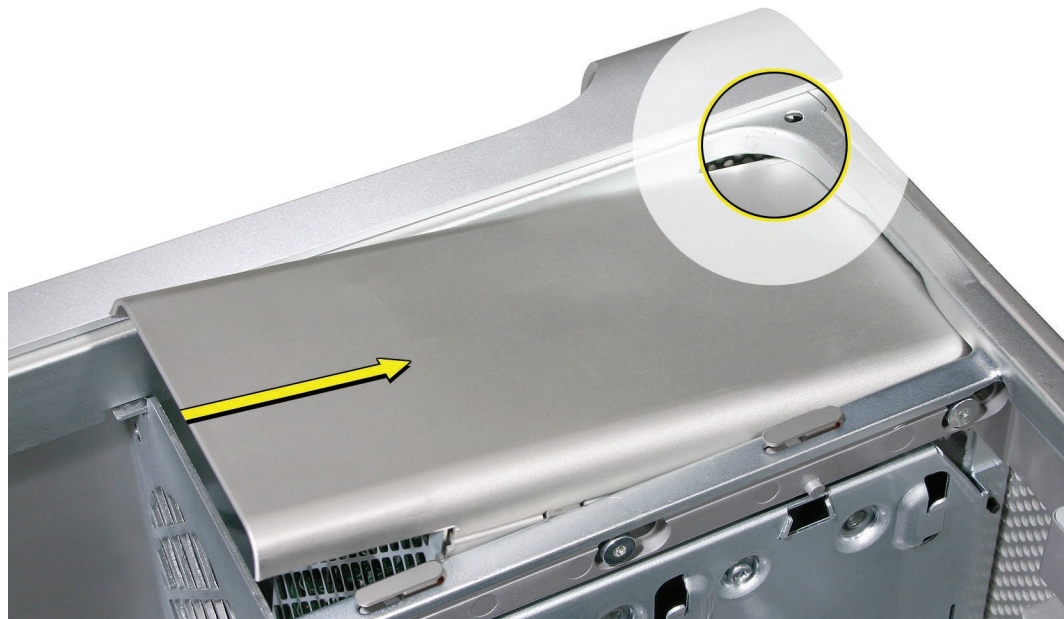

- Slide the power supply toward the back of the computer as far as possible.



- Make sure the power receptacle aligns with the opening in the enclosure's back panel and the four screw holes in the power supply align with the screw holes in the media shelf.
- Replace the four power supply mounting screws.

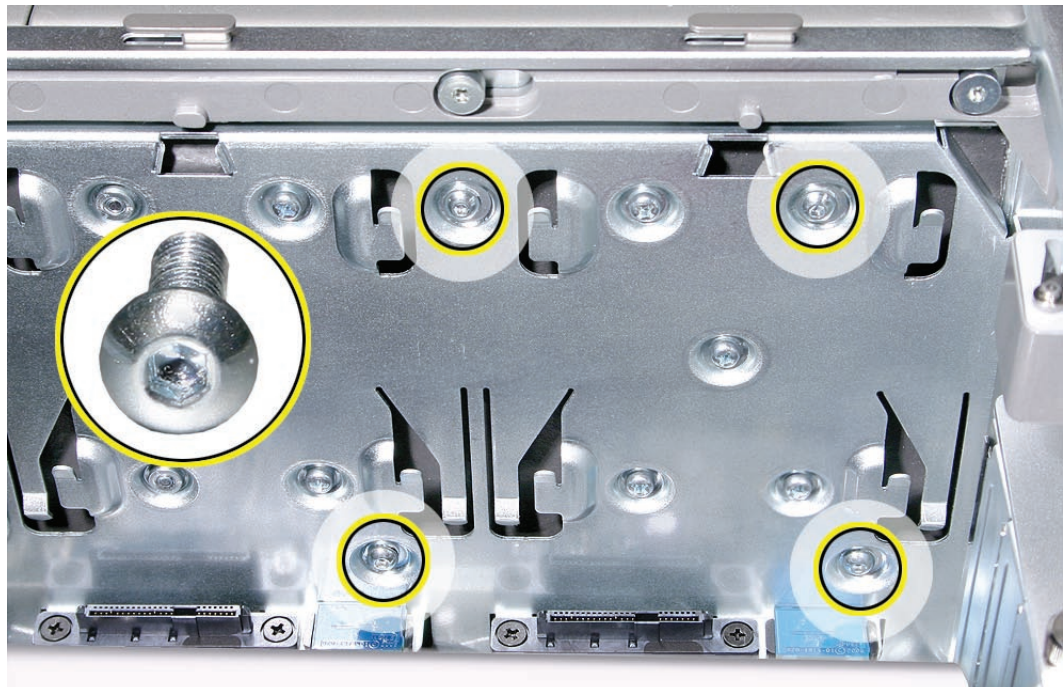



Power Supply Fan

Tools

The only tools required for this procedure are a magnetized 2.5 mm hex wrench and needlenose pliers. You may also find scissors or wire cutters helpful.

Preliminary Steps

Before you begin, open the computer, lay it on its side with the access side facing up, and remove the following:

- [Hard drives and hard drive carriers in drive bays 3 and 4](#)
- [Optical drive carrier and optical drives](#)
- [Any PCI Express cards that block access to the power supply mounting screws](#)

Part Location



Procedure

Note: To remove the power supply fan, you must first move the power supply out of the way; you do not, however, have to remove the power supply entirely from the enclosure.

1. Using a magnetized 2.5 mm hex wrench, remove the four power supply mounting screws from the bottom of the media shelf.

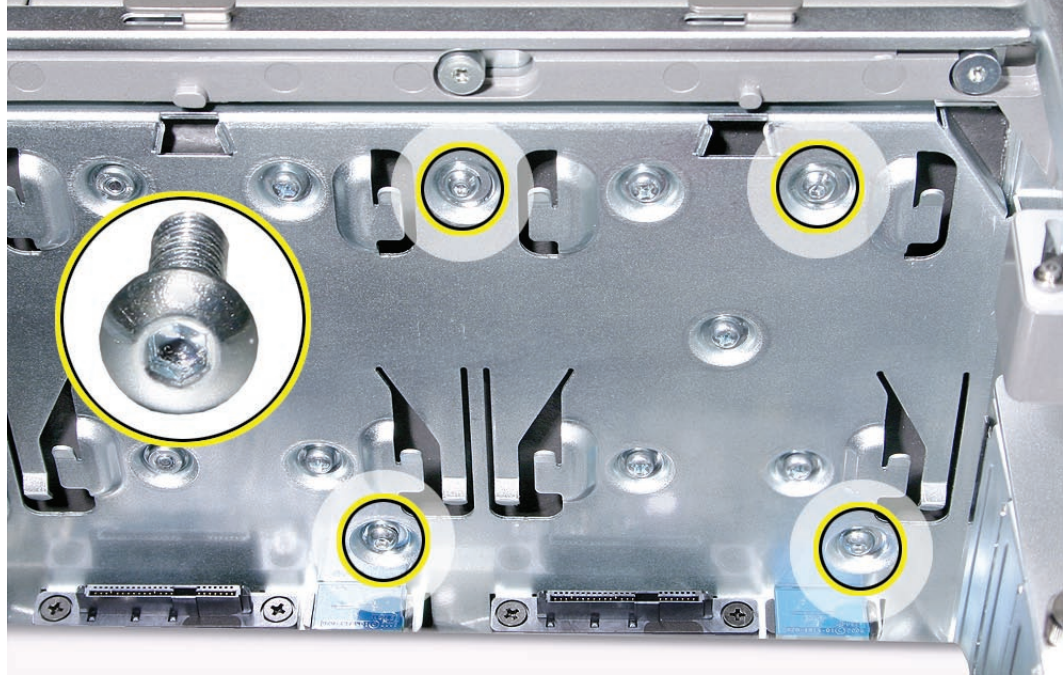

2. Depress the upper right corner of the power supply and slide the power supply toward the front of the computer.

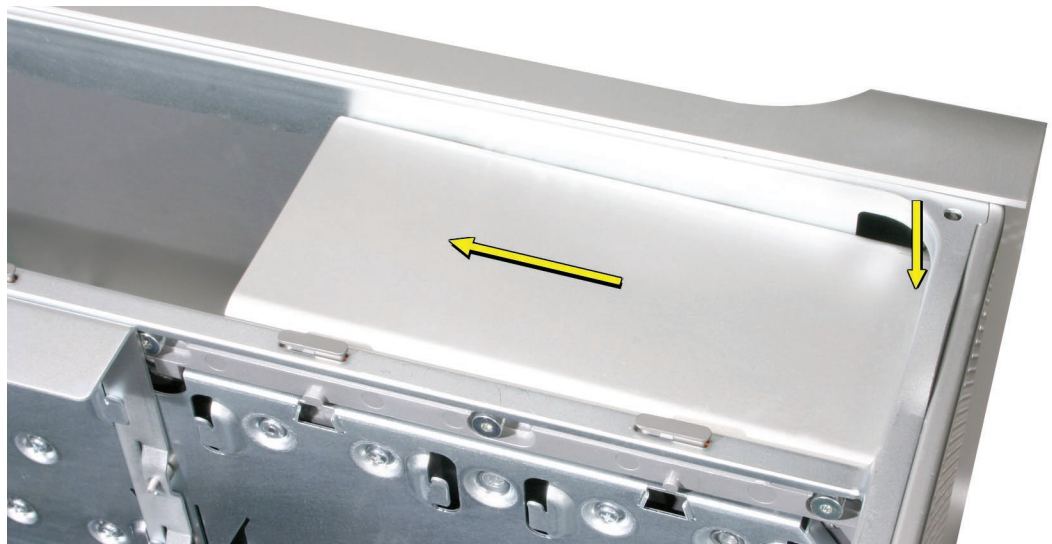

Note: Before beginning the next step, place a soft cloth over the edge of the enclosure to prevent scratches from the power supply.

3. Lift the power supply a short distance and rest it on the edge of the enclosure.



Note: The power supply is still connected to the enclosure by its cable. When moving the power supply to the edge of the enclosure, be careful not to put too much tension on the cable.

4. Disconnect the power supply fan cable from the logic board and thread the cable through the opening in the media shelf.

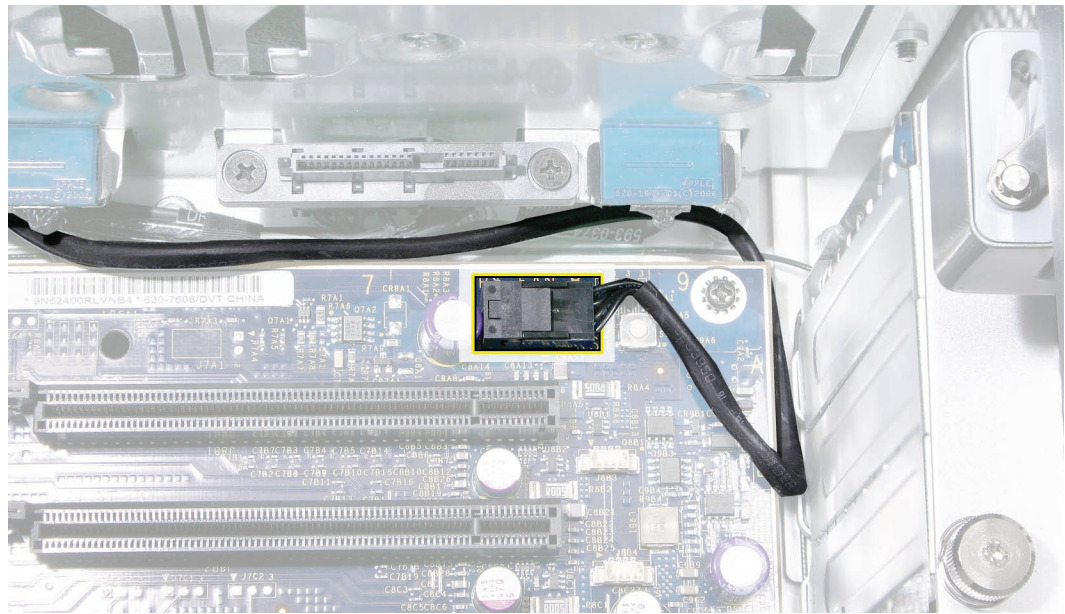

5. Using needlenose pliers, pull out the four grommets that mount the power supply fan to the media shelf divider.

Note: You may find scissors or wire cutters useful in snipping off the grommet heads.

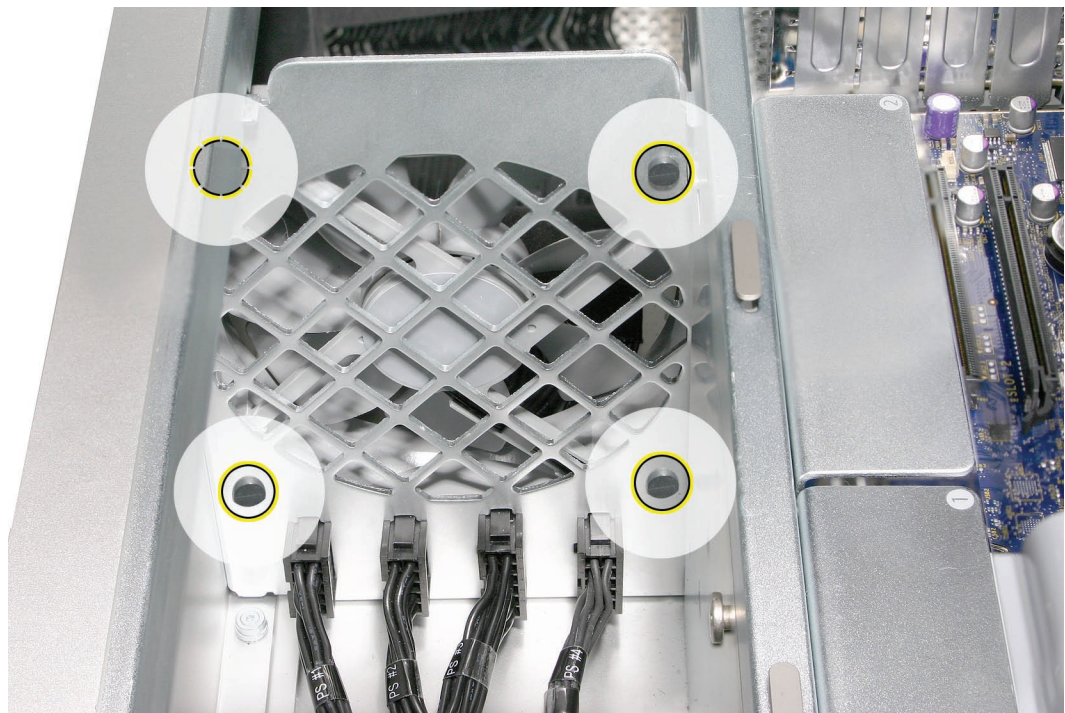

6. Rotate the fan and remove it from the enclosure.



Replacing the Power Supply Fan

1. Place the power supply fan in the media shelf and thread the fan's cable through the opening in the shelf.
2. Connect the cable to the logic board.
3. Rotate the fan into place flush against the media shelf divider. Make sure the back of the fan faces the divider, as illustrated.



Note: To secure the power supply fan to the divider, use the long-tailed grommets enclosed with the replacement fan.

4. Thread the first grommet, tail first, through one of the four grommet holes in the divider and on through the corresponding grommet hole in the fan bracket. Then pull to secure the grommet and detach the excess threading tail. (The tail is notched to break off at the correct place.)
5. Repeat for the other three grommets.



6. Fold the power supply cable on the bottom of the power supply bay.
7. Holding the power supply at an angle, as illustrated, lower it into the enclosure until its upper right corner slides under the corner lip of the enclosure.



8. Slide the power supply toward the back of the computer as far as possible.

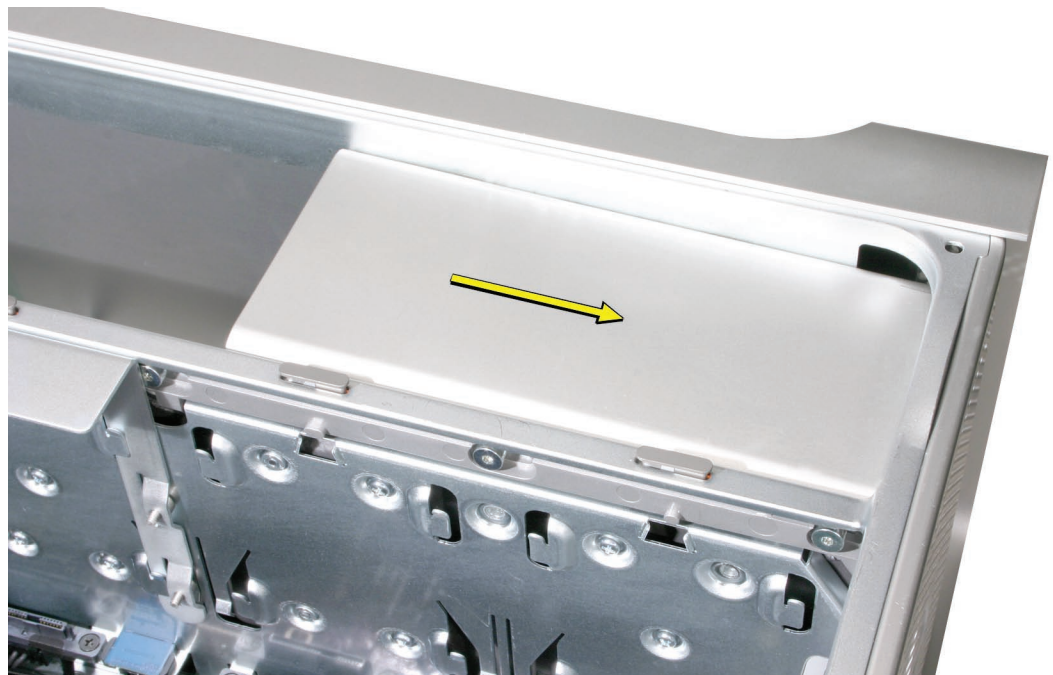

9. Make sure the power receptacle aligns with the opening in the enclosure's back panel and the four screw holes in the power supply align with the screw holes in the media shelf.
10. Replace the four power supply mounting screws.

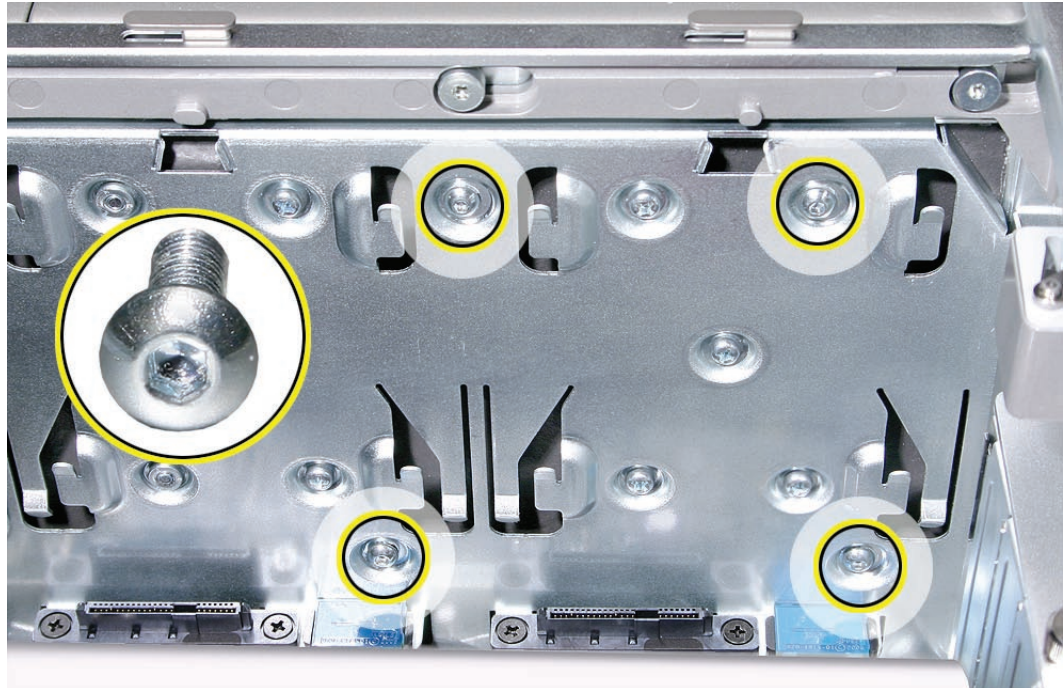



AirPort Extreme Card

Important: The computer enclosure includes AirPort antenna wires and a Bluetooth antenna wire. The Bluetooth antenna wire looks similar to the AirPort antenna wires, except that it includes a “BT” label. For proper operation, be careful not to connect the Bluetooth antenna wire to the AirPort card or any AirPort antenna wire to the Bluetooth card.

Note: You may connect the AirPort antenna wires to either AirPort card connector.

Tools

The only tool required for this procedure is a magnetized jewelers Phillips #1 screwdriver.

Preliminary Steps

Before you begin, open the computer, and lay it on its side with the access side facing up.

Part Location

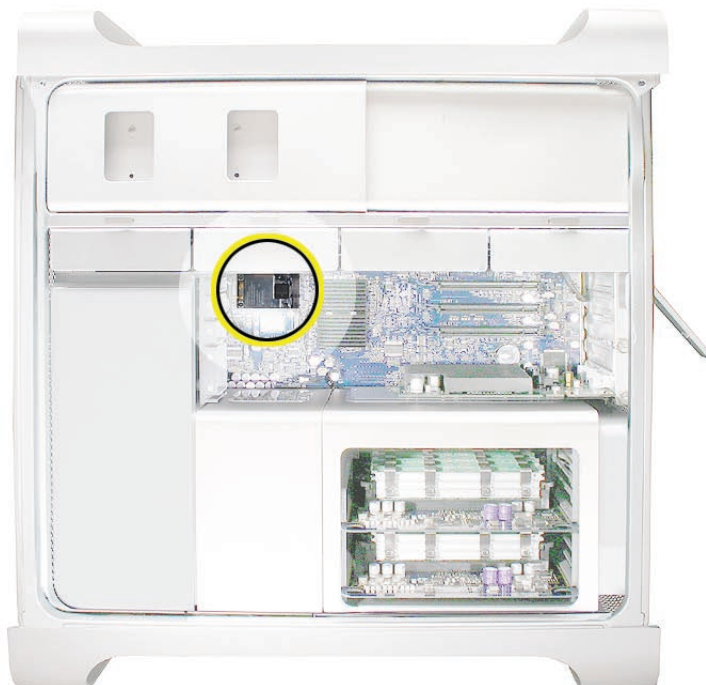

Procedure

1. Remove the two AirPort Extreme card mounting screws.

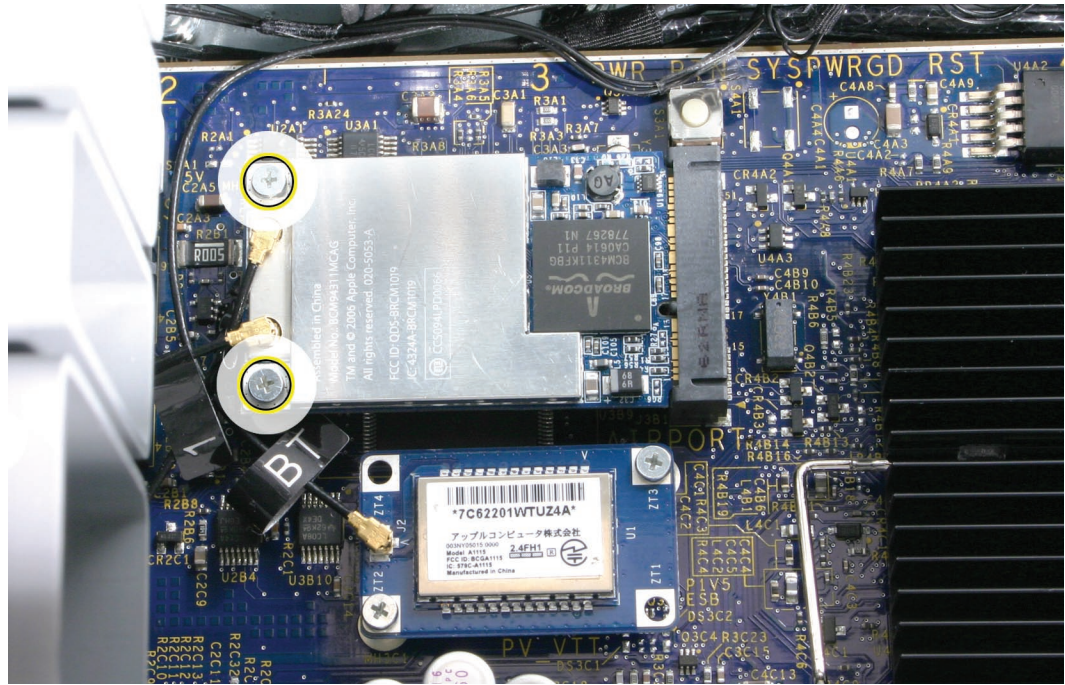

2. Lift the AirPort Extreme card a short distance from the logic board.
3. Disconnect the AirPort antenna wires from the card.

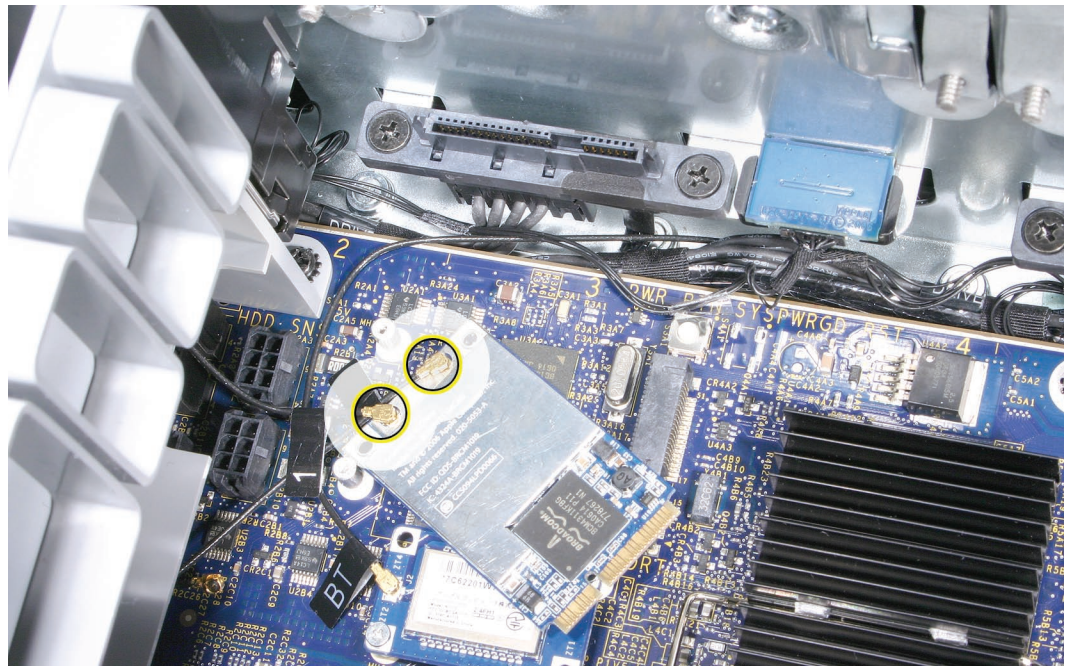

4. Remove the card from the enclosure.

Replacement Note: To replace the AirPort Extreme card, do the following:

- Connect the antenna wires to the card.
Important: Be sure to connect the wires that are marked 1 and 3 to the card; the antenna wire that is marked 2 should be taped out of the way.
- Insert the card into its logic board connector at an angle, as illustrated.
- Lower the screw end of the card down to the standoffs on the logic board and replace the two mounting screws.

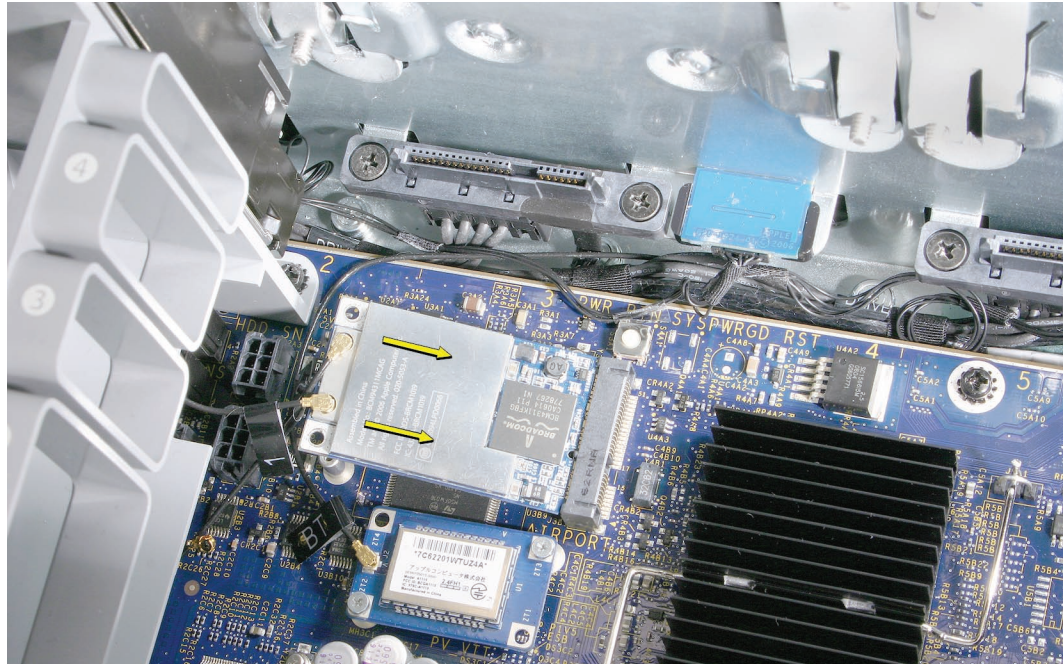

Note: If you are not replacing the AirPort card, cover the connectors on the AirPort antenna wires with Kapton or other non-conductive tape to prevent them from shorting out components on the logic board.



Bluetooth Card

Important: The computer enclosure includes one Bluetooth antenna wire, which looks similar to the AirPort antenna wires, except that it includes a “BT” label. For proper operation, be careful not to connect the Bluetooth antenna wire to the AirPort card or any AirPort antenna wire to the Bluetooth card.

Tools

The only tool required for this procedure is a magnetized jewelers Phillips #1 screwdriver.

Preliminary Steps

Before you begin, open the computer, and lay it on its side with the access side facing up.

Part Location

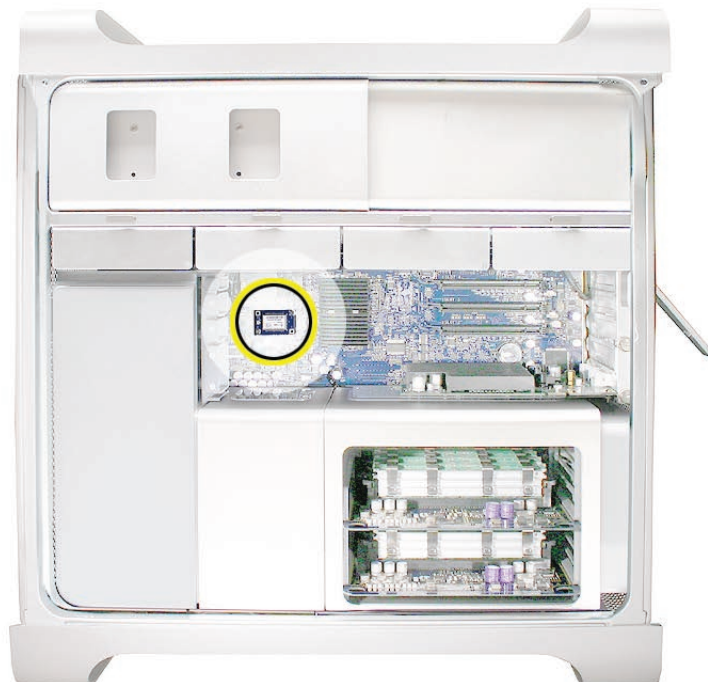

Procedure

1. Remove the two Bluetooth card mounting screws.

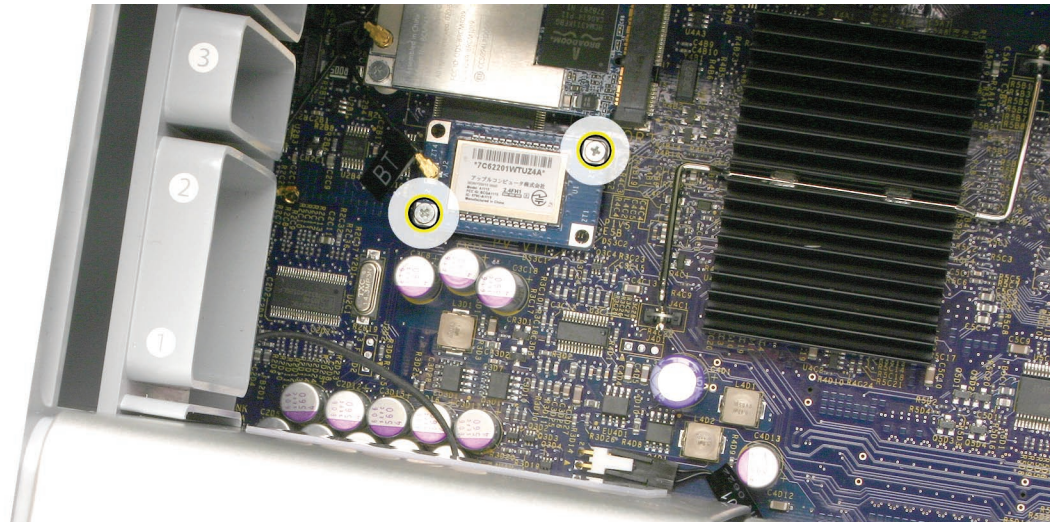

2. Lift the Bluetooth card a short distance from the logic board.
3. Disconnect the Bluetooth antenna wire from the card.
4. Remove the card from the enclosure.

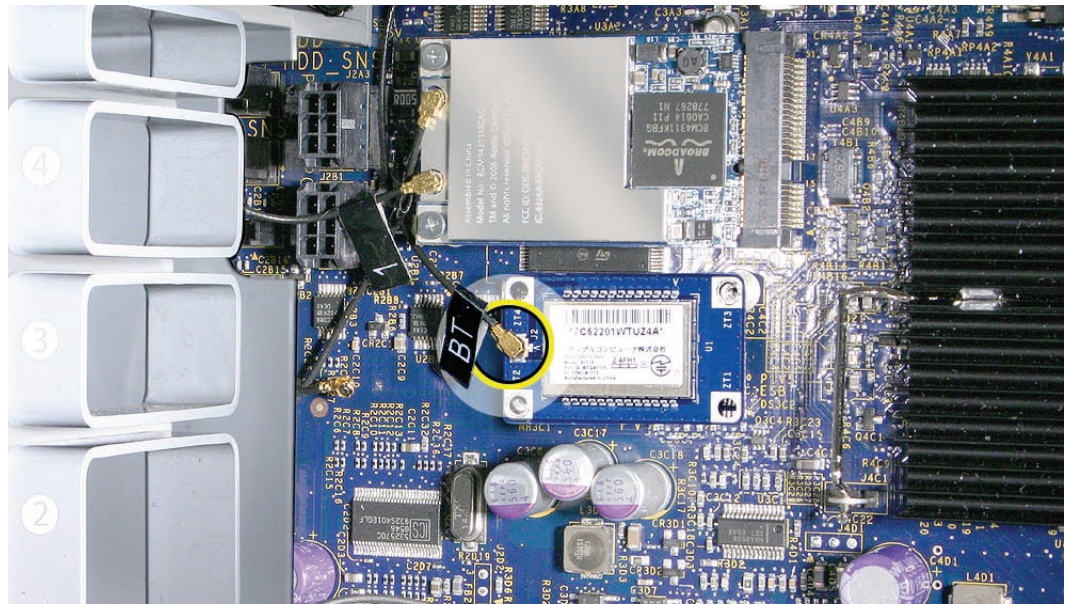

Note: If you are not replacing the Bluetooth card, cover the connector on the Bluetooth antenna wire with Kapton or other non-conductive tape to prevent it from shorting out components on the logic board.



Battery

Tools

No tools are required for this procedure. You may, however, find a flat-blade screwdriver useful in removing the battery from its holder.

Preliminary Steps

Before you begin, open the computer, lay it on its side with the access side facing up, and remove any [PCI Express cards](#) that block access to the battery.

Part Location



Procedure

1. Slide the battery out from underneath the battery holder's metal clip.
2. Remove the battery from its holder.

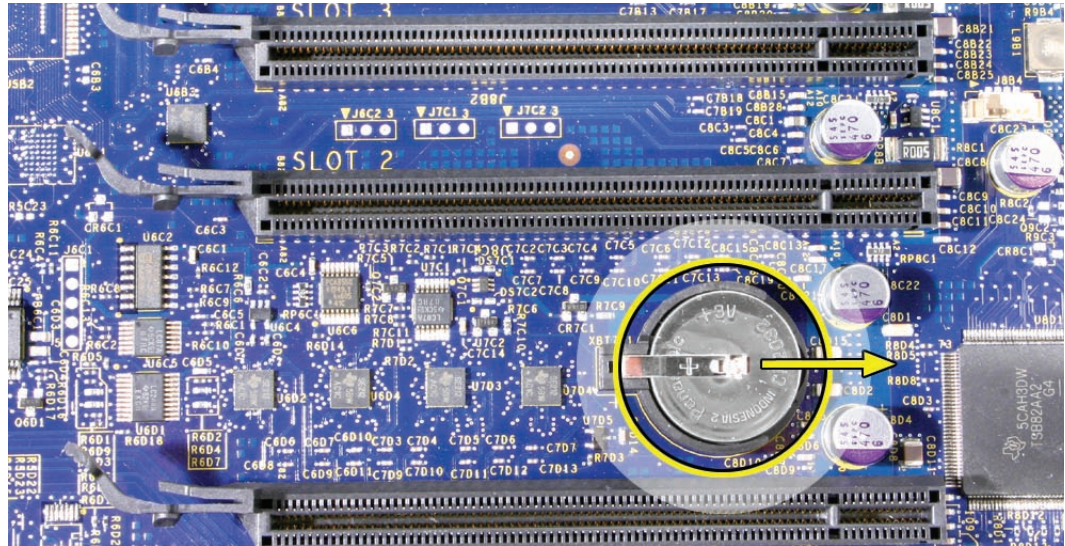

Replacement Note: Insert the new battery into the holder, making sure the battery's positive symbol (+) faces up.

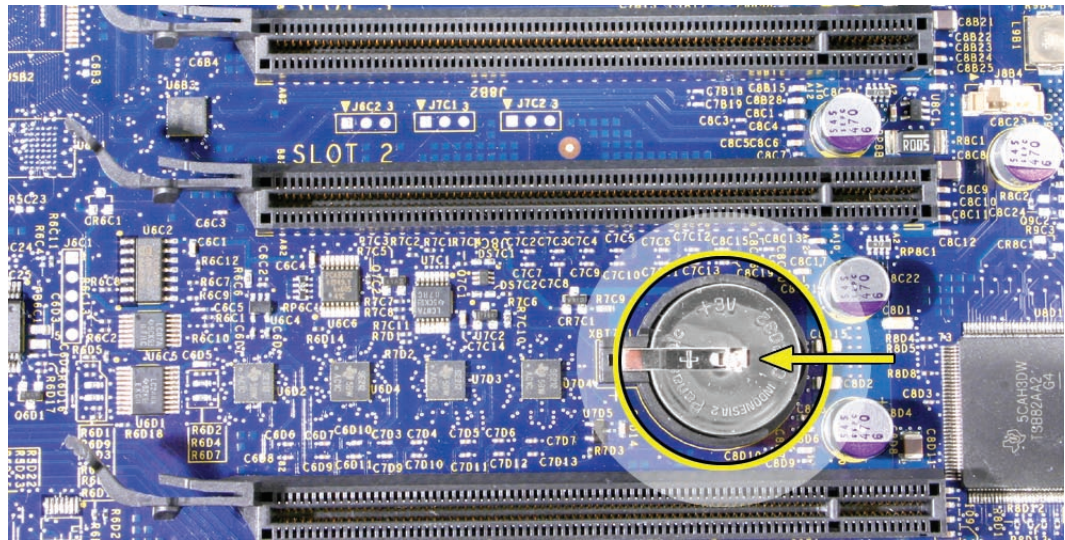

Warning: Installing the battery incorrectly may cause an explosion. Be sure the battery's positive and negative sides are correctly oriented in the holder. Use only the same type of battery or an equivalent recommended by the manufacturer of the original.

Important: Batteries contain chemicals, some of which may be harmful to the environment. Please dispose of used batteries according to your local environmental laws and guidelines.



Processor Heatsink Cover

Tools

The only tools required for this procedure are the following:

- Long-handled, magnetized #1 Phillips screwdriver
- Short-handled, magnetized jeweler's #1 Phillips screwdriver or right-angle, magnetized #1 Phillips screwdriver
- Apple Mac Pro wrench (part number 922-8025)
- Flat-blade screwdriver

Preliminary Steps

Before you begin, open the computer, lay it on its side with the access side facing up, and remove the following:

- [PCI Express card installed in slot 1](#)
- [Top and bottom memory cards](#)

Part Location

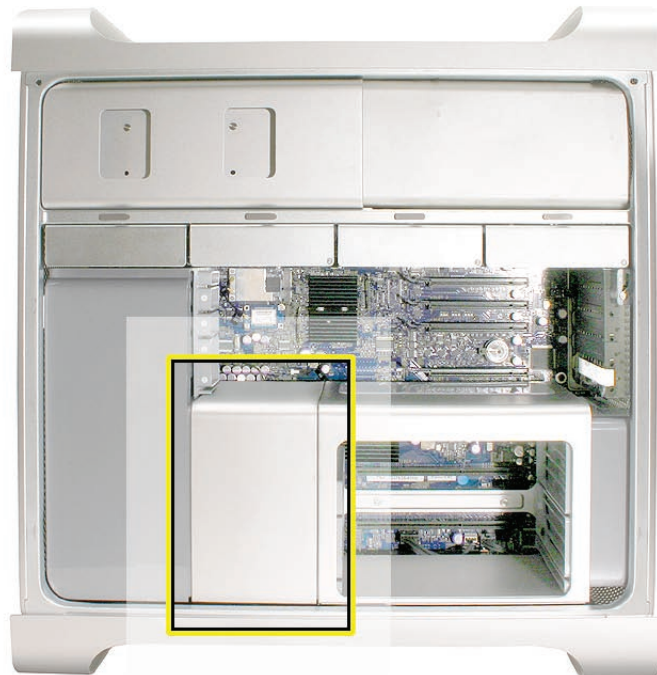

Procedure

Note: To remove the heatsink cover, you must first slide the memory cage toward the back panel.

1. Using a long-handled, magnetized #1 Phillips screwdriver, remove the two long screws that mount the memory cage to the logic board.
2. Using a short-handled, magnetized jeweler's #1 Phillips screwdriver or right-angle, magnetized #1 Phillips screwdriver, carefully remove the two short screws that mount the memory cage to the bottom panel of the enclosure.



Important: As you start to unscrew each short screw, look directly below the cage for the screw's standoff. If the standoff starts to turn as you turn the screwdriver, use the Apple Mac Pro wrench (part number 922-8025) to hold the standoff in place while you turn the screw.



If either of the two short mounting screws for the memory cage strip while you are attempting to remove it, the screw will stay attached to its hex standoff located below the cage and you will be unable to remove the screw. In this case, do the following.

Note: To avoid scratching the enclosure in the following step, place a piece of sticky note paper or removable masking tape over the enclosure edge where you insert the wrench.

- Insert the Apple Mac Pro wrench (part number 922-8025) around the hex standoff located directly below the stripped screw, as illustrated. Turn the wrench to separate the hex standoff from the enclosure. If both screws are stripped, alternate turning the wrench between the two standoffs so that the memory cage rises evenly.

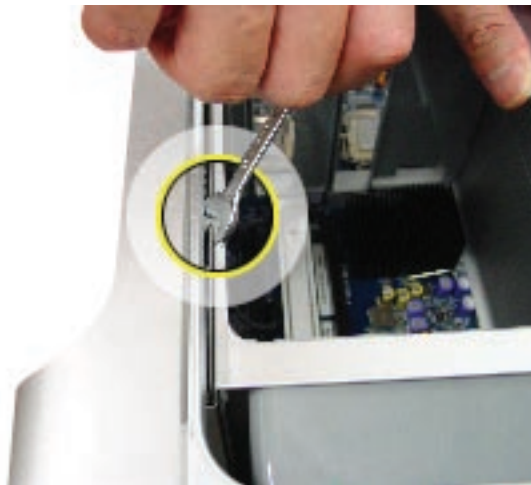

- Using a flat-blade screwdriver, lift the cage over both standoffs and slide the cage as described in step 3.



See also the [replacement note for cages with stripped screws in “Memory Cage with Rear Fan.”](#) In addition, order screw 922-7703 to replace any stripped, short screws used in securing the memory cage.

3. Slide the memory cage toward the rear panel of the computer.

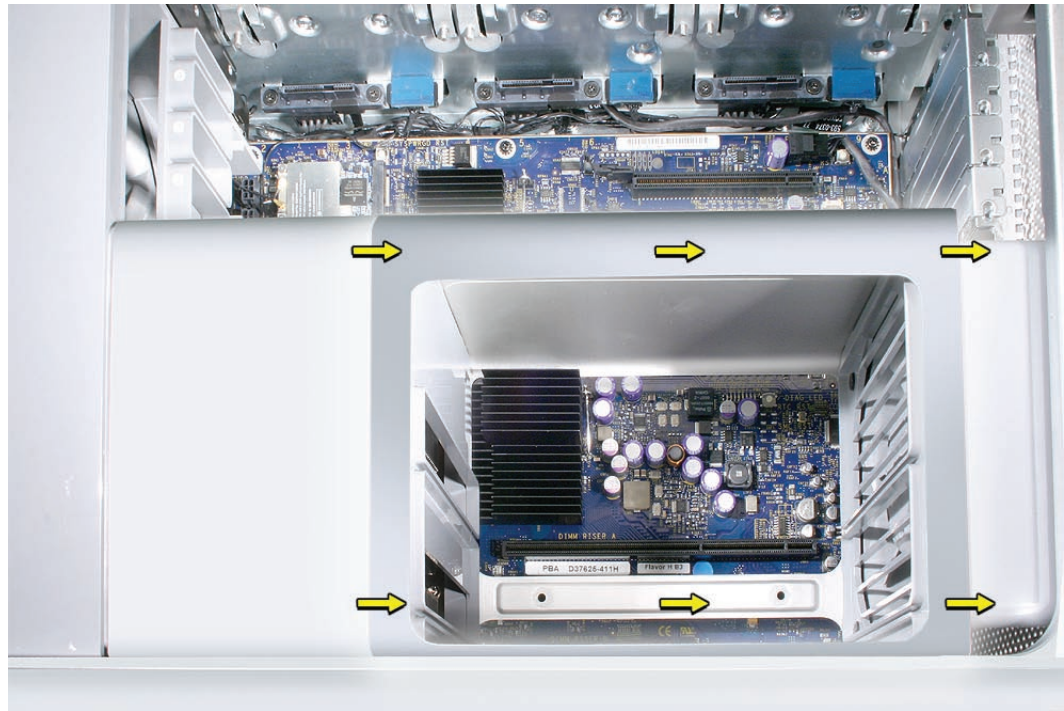

Lift the heatsink cover slightly, rotate it as illustrated, and remove the cover from the enclosure.



Replacement Note: When reinstalling the processor heatsink cover, do the following:

- Make sure the heatsink cover slides below slot #1 on the PCI card guide, which is attached to the front fan assembly.

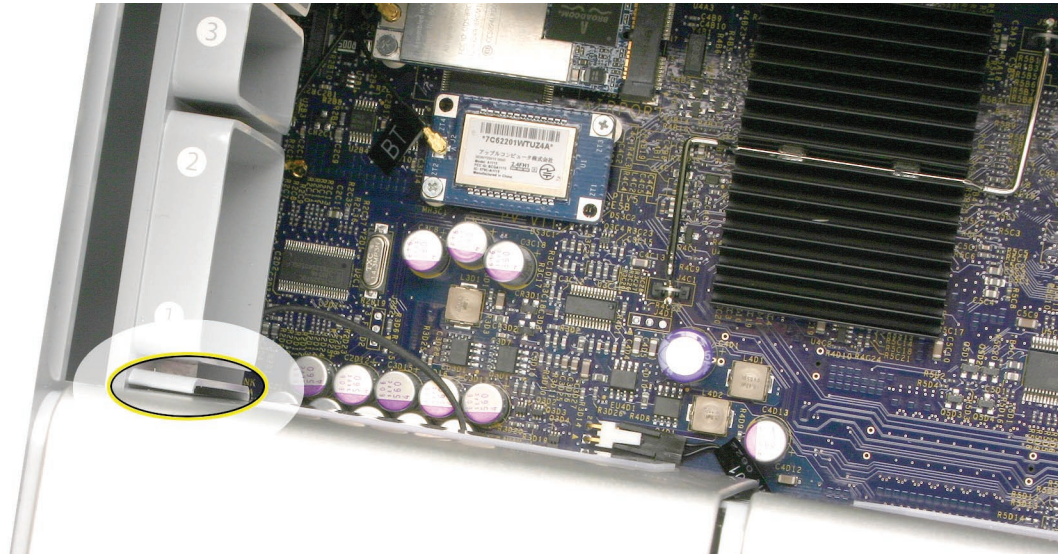

- Align the four slots on the underside of the heatsink cover's left edge with the four tabs on the front fan before snapping the heatsink cover into place. (The slots on the underside of the cover's right edge should automatically align with the tabs on the memory cage, once you slide the cage back into its original position.)



- Slide the memory cage back into place and secure it with the four mounting screws, making sure you do not over-torque the screws.



Front Fan Assembly

Tools

The only tools required for this procedure are a long-handled, magnetized #1 Phillips screwdriver and the cover from a PCI Express card slot.

Preliminary Steps

Before you begin, open the computer, lay it on its side with the access side facing up, and remove the following:

- [Hard drives and hard drive carriers in drive bays 1 and 2](#)
- [PCI Express card installed in slot 1](#)
- [Any 12-inch PCI Express cards](#)
- [Top and bottom memory cards](#)
- [Processor heatsink cover](#)

Part Location



Procedure

1. Using a long-handled, magnetized #1 Phillips screwdriver, remove the front fan assembly mounting screw.

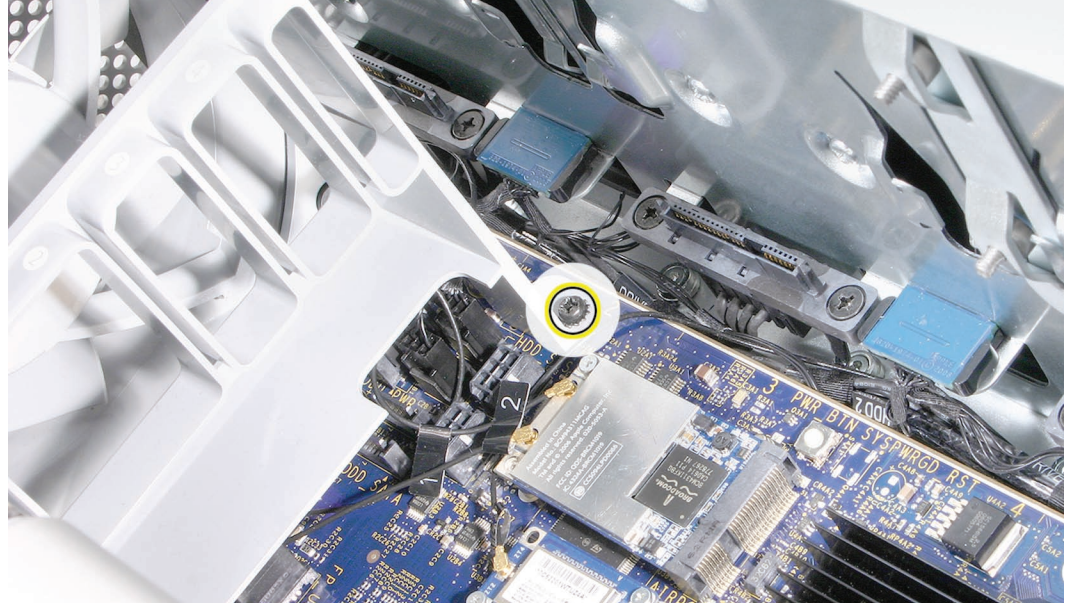

2. Insert the right-angle end of a cover for one of the PCI Express card slots between the enclosure and the lower left edge of the front fan, and using force, lift straight up. Then gripping the front fan by the upper right edge and the lower left edge, lift straight up and remove the fan from the enclosure.

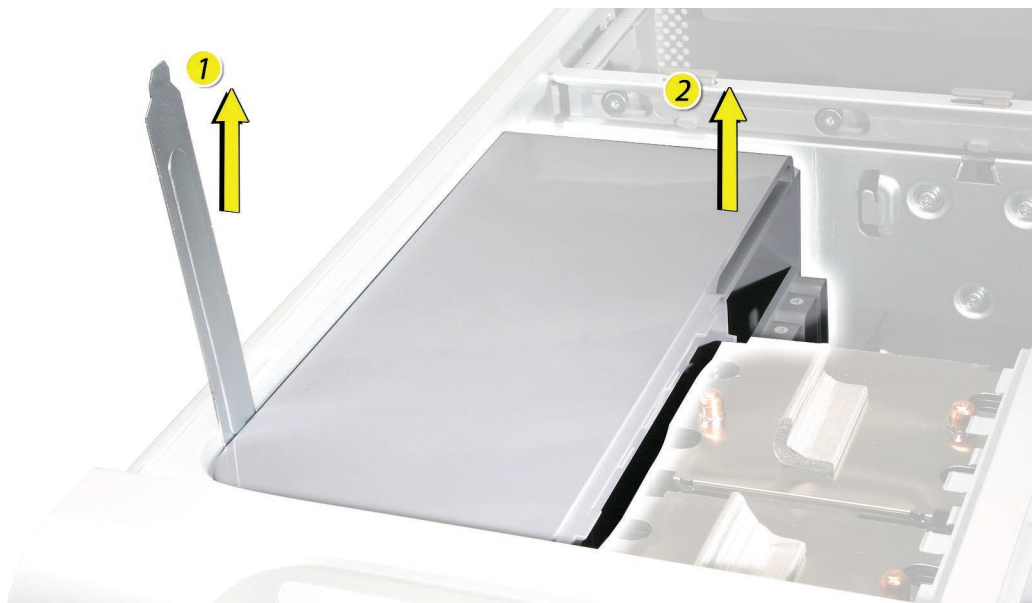

Note: You may have to use some force when lifting the fan assembly from the enclosure.

Replacement Note: When lowering the front fan into the enclosure, slide the guide on the base of the fan assembly into the channel on the speaker assembly.



Also make sure the latch on the inside top left edge of the fan assembly engages with the slot on the inside lip of the enclosure. Then press down until you hear the fan click into place in the connector on the logic board



Replacement Note: Be careful not to crimp any AirPort or Bluetooth antenna wires under the fan assembly. Also make sure that the fan cables are routed in the fan channel.



Mac Pro RAID Card & Battery

Note: If a Mac Pro RAID Card is installed in a Mac Pro, the standard iPass cable routing has been changed so that the cable connects to the card, rather than to the logic board.

Tools

The only tool required for this procedure is a Phillips #1 screwdriver. You might also find a small flat-blade screwdriver helpful in releasing the iPass cable connector.

Preliminary Steps

Before you begin, open the computer, lay it on its side with the access side facing up, and remove the following:

- [All hard drives and hard drive carriers](#)
- [PCI Express card installed in slot 1 and any 12-inch PCI Express cards](#)
- [Top and bottom memory cards](#)
- [Processor heatsink cover](#)
- [Front fan assembly](#)

Part Location

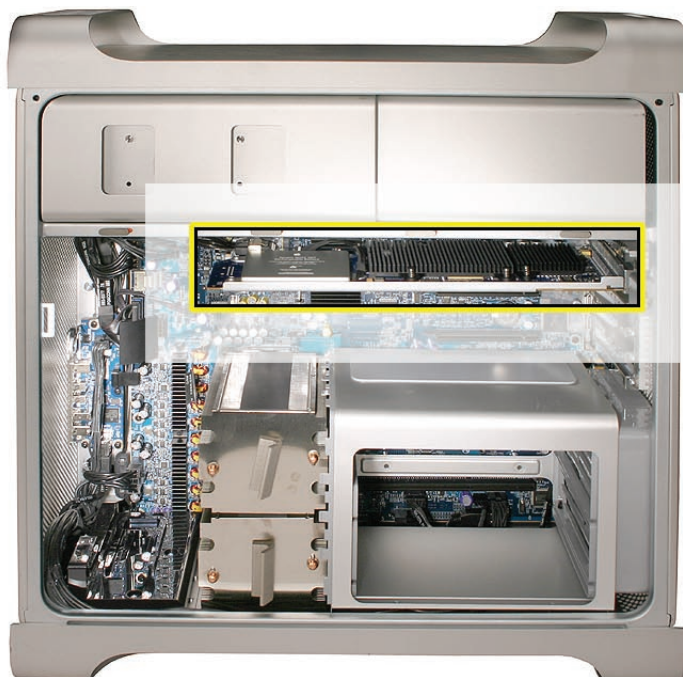

Procedure

1. If you have not already done so, loosen the two captive screws that secure the PCI bracket to the enclosure and remove the bracket.

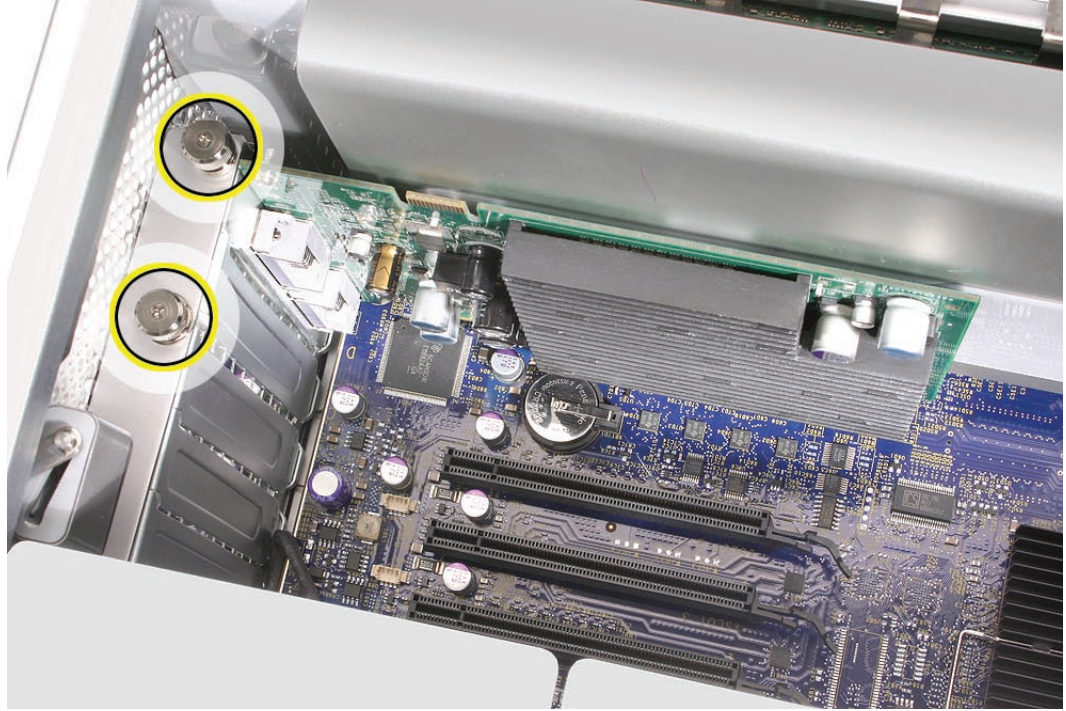

Warning: When removing or installing a card, handle it only by the edges. Do not touch its connectors or any of the components on the card. Lift the card straight out from the connector to remove it, and insert it straight into the connector to install it. Do not rock the card from side to side and don't force the card into the slot. Once the replacement card is installed, pull on it gently to check that it is properly connected.

2. Release the small locking clip at the front of the card's logic board connector by pushing the clip up toward the media shelf.
3. Holding the card by the top corners, gently pull up the card and remove it from its expansion slot.

Note: The Mac Pro RAID Card must always be installed in slot 4.

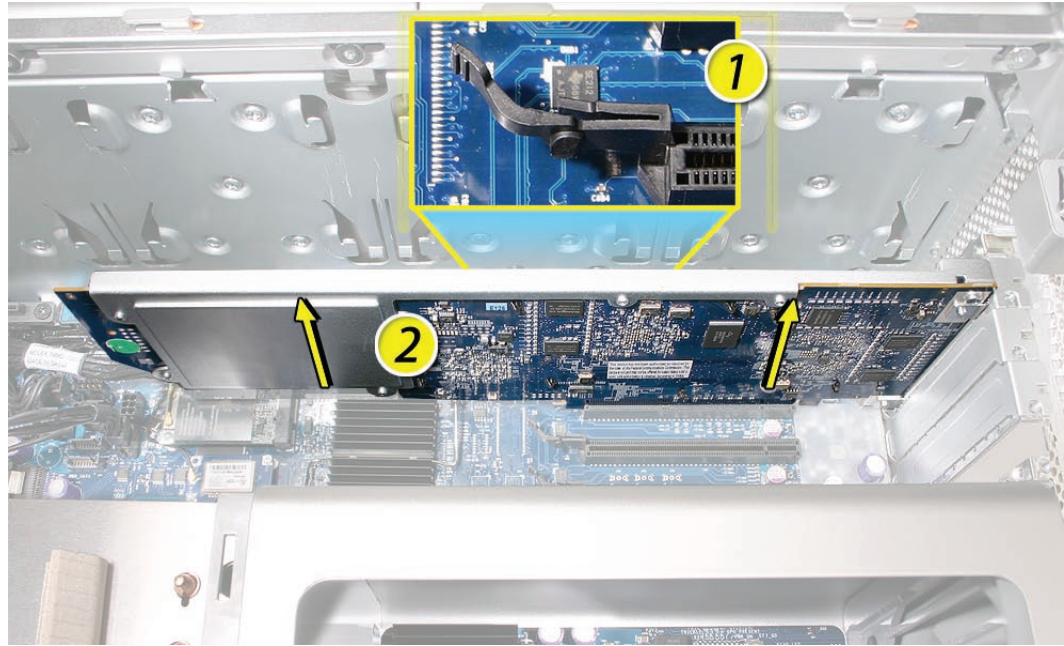

4. Disconnect iPass cable from the Mac Pro RAID Card.

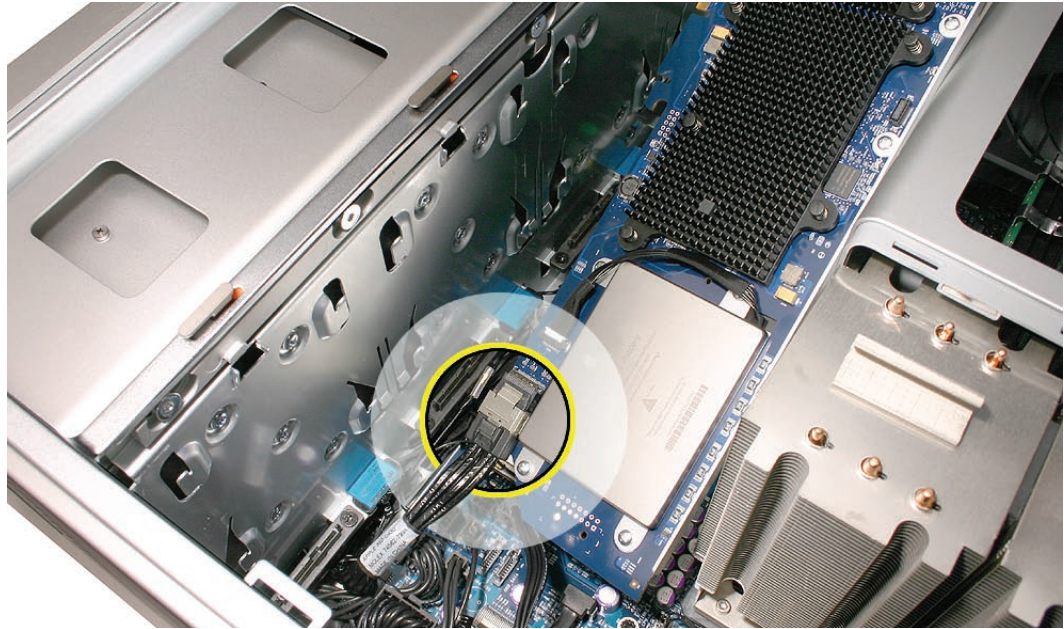

Note: You may find it helpful to use a small, flat-blade screwdriver to release the cable connector. Depress the rear edge of the silver-colored latch on top of the connector.

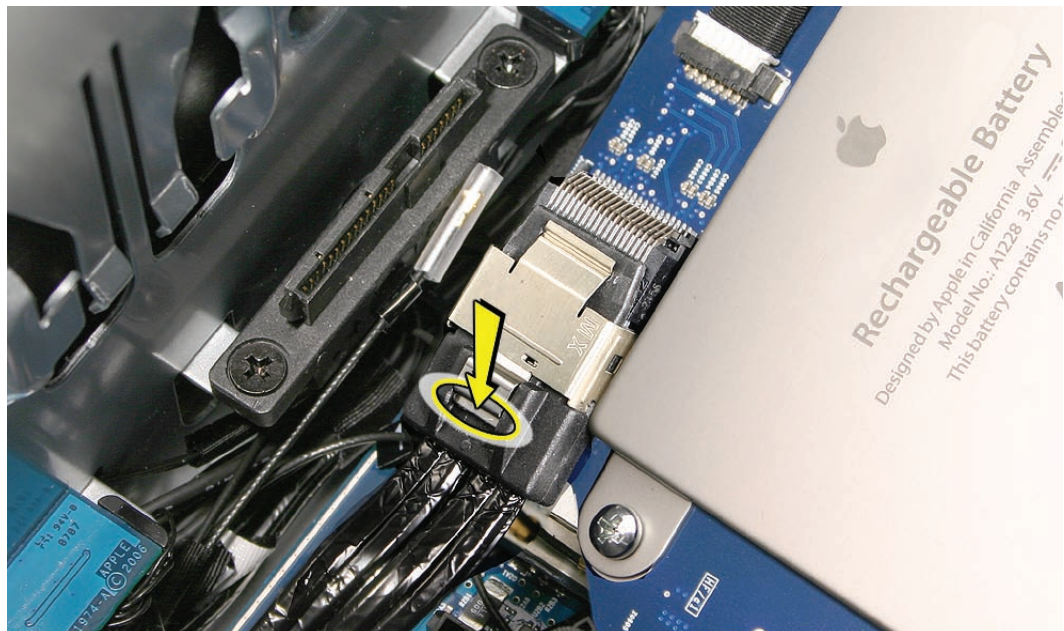

5. Remove the card from the enclosure.

6. The Mac Pro RAID Card includes its own battery.

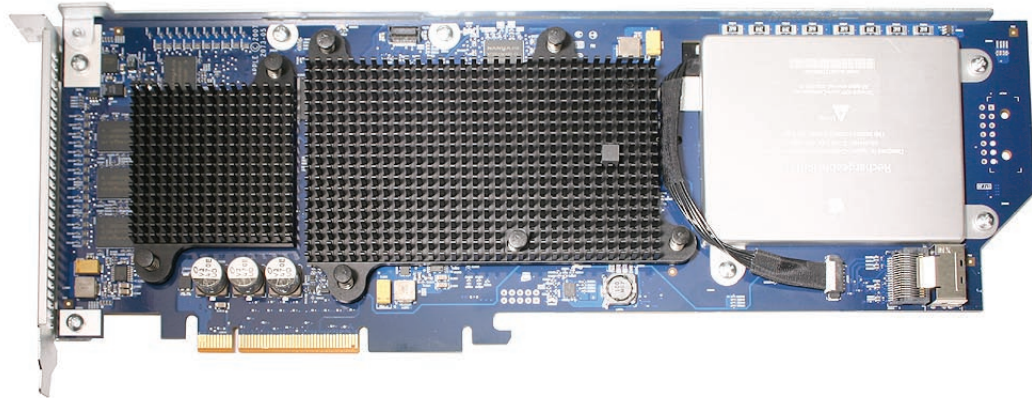

If you are replacing the battery on the card, do the following:

- Disconnect the battery cable from the card.
- Remove the four mounting screws and lift the battery from the card.



Important: Do not drop, disassemble, crush, incinerate, or expose the battery to temperatures above 212° F (100° C). Stop using the battery if it appears damaged in any way. Replace the battery only with an Apple-authorized battery for this product. Dispose of used batteries promptly according to your local environmental guidelines.

Replacing the Mac Pro RAID Card

1. Connect the iPass cable to the Mac Pro RAID Card.
2. Align the card's connector with expansion slot 4 and press until the connector is inserted all the way into the slot. Make sure the card also engages slot 4 in the PCI card guide.

Note:

- Don't rock the card from side to side; instead, press the card straight into the slot.
- Don't force the card. If you meet a lot of resistance, pull the card out. Check the connector and the slot for damage or obstructions, then try inserting the card again.
- Pull the card gently to see if it is properly connected. If it resists and stays in place and its gold connectors are barely visible, the card is connected.

Note: System Profiler does not display the serial number for the Mac Pro RAID Card. You can find the serial number by checking the serial number sticker on the back of the card.



Processor Heatsinks

Note: The processor heatsink requires thermal grease for proper operation. Every time you remove the processor heatsink, you must replace the thermal grease. New grease and alcohol wipes for cleaning off the previous grease are included with replacement processors and logic boards. Instructions for applying the grease are included with this procedure. Note that replacement processor heatsinks come with the grease already applied.

Tools

The only tool required for this procedure is a long-handled, magnetized 3 mm flathead hex screwdriver.

Preliminary Steps

Before you begin, open the computer, lay it on its side with the access side facing up, and remove the following:

- [Hard drives and hard drive carriers in drive bays 1 and 2](#)
- [PCI Express card installed in slot 1](#)
- [Any 12-inch PCI Express cards](#)
- [Top and bottom memory cards](#)
- [Processor heatsink cover](#)
- [Front fan assembly](#)

Part Location

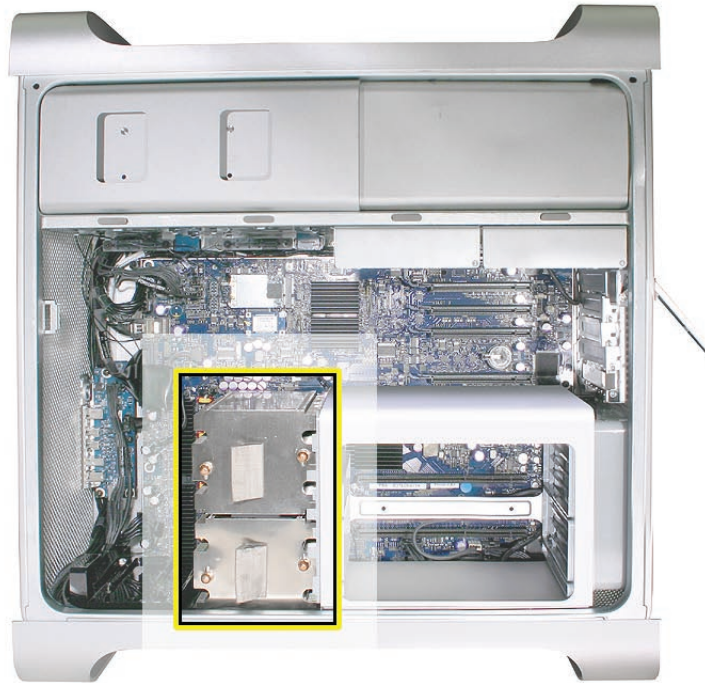

Procedure

1. Disconnect the 2-pin cable for the upper processor (CPU A) heatsink from the logic board.

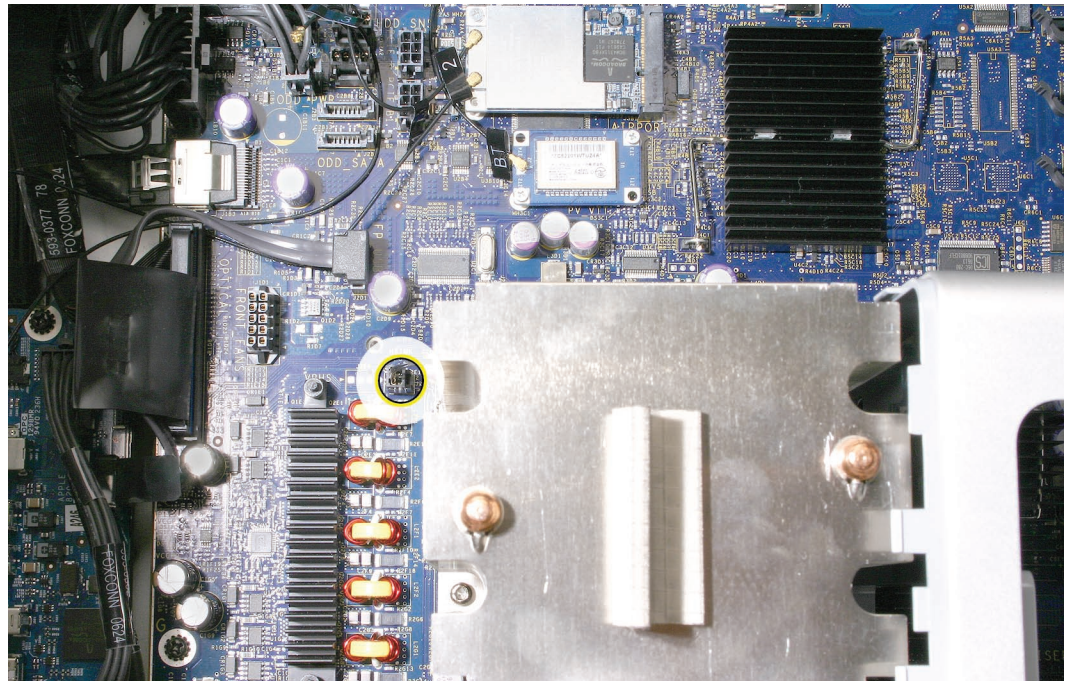

- Using a long-handled, magnetized 3 mm flathead hex screwdriver, loosen the four captive mounting screws for the upper processor heatsink in the order indicated below.

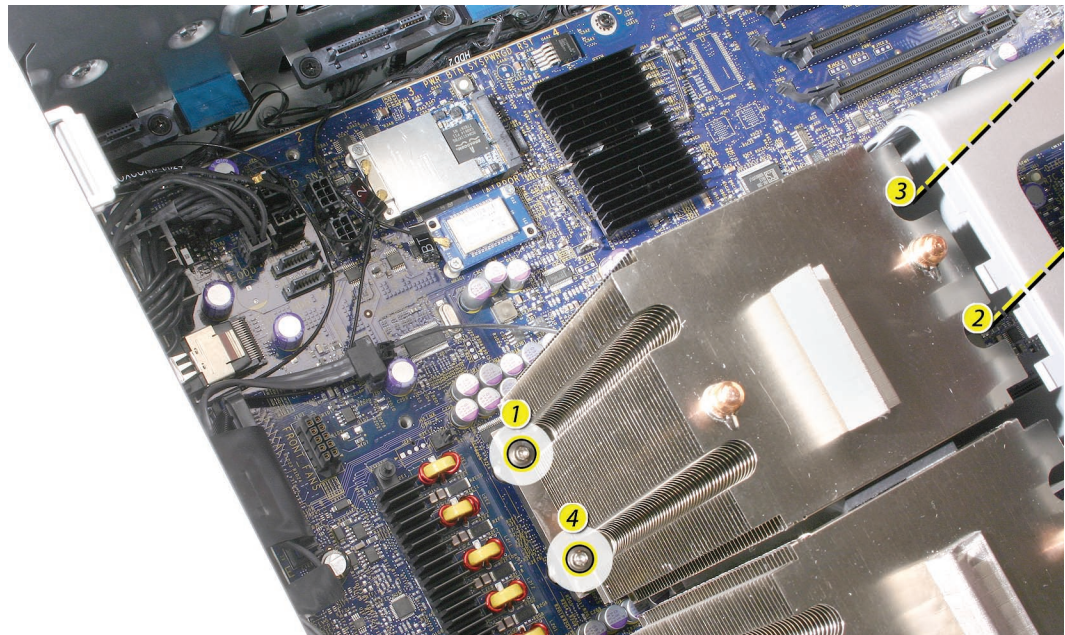

- Lift the heatsink straight up and out of the enclosure.
- Move the memory cage out of the way so that you can locate the cable connector for the lower processor heatsink.
- Disconnect the cable.

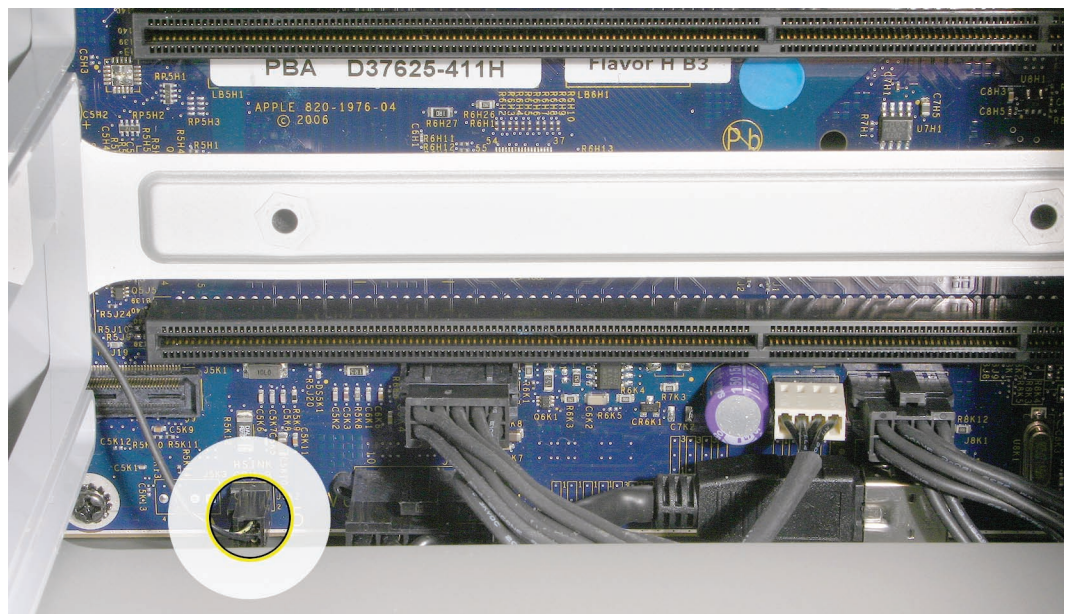

- Repeat steps 2 and 3 for the lower processor (CPU B) heatsink.

Replacement Note: Before reinstalling an existing processor heatsink, follow these directions for applying new thermal grease to the underside of the heatsink.

- Using the alcohol pad included with the logic board or processor replacement part, clean off any used thermal grease from the processor and the bottom of the heatsink.
- Using the thermal grease included with the logic board or processor replacement part, apply one dot of fresh grease to the raised square area on the bottom of the heatsink.
- Spread the grease evenly across the square to a thickness of approximately 1 mm.

Warning: Do not apply more grease than recommended. The grease must not overflow the heatsink and come in contact with the processor connector.

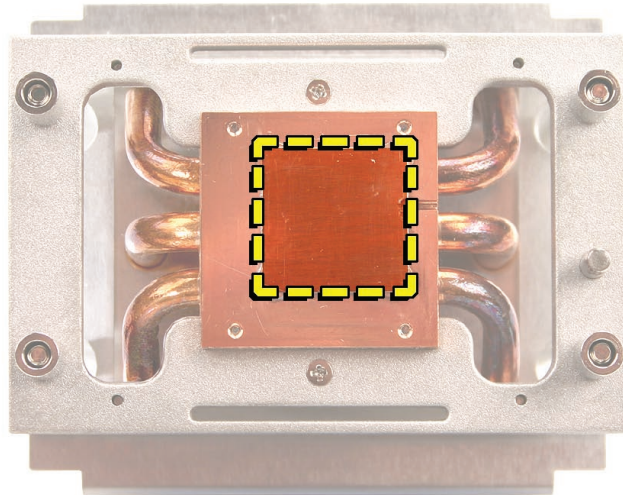

- Carefully align the posts on the heatsink with the mounting holes in the logic board, and lower the heatsink straight down onto the processor.
- To ensure the grease spreads evenly over the processor, lightly tighten the heatsink mounting screws in the order indicated below.

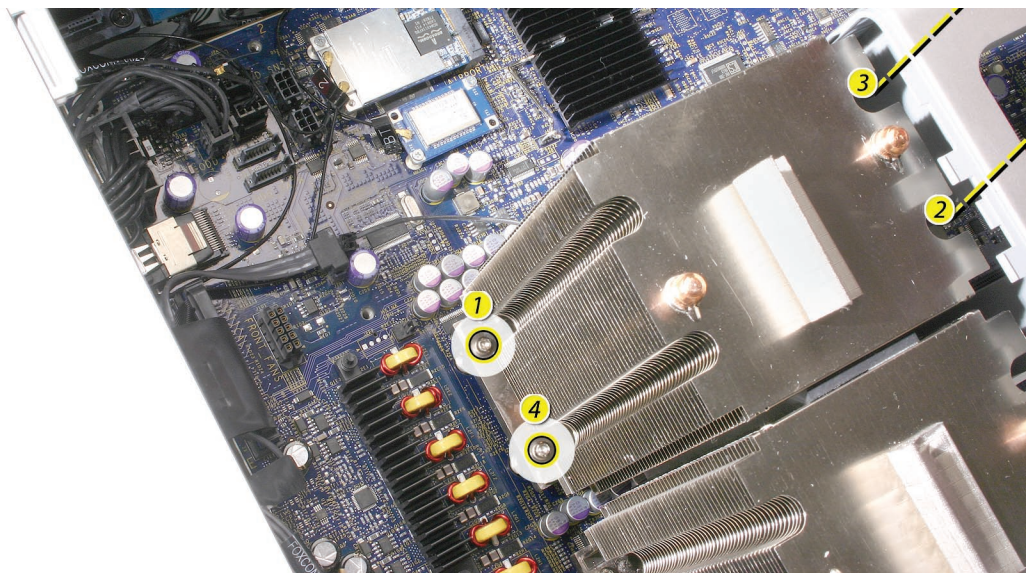

- To affix the heatsink to the processor, again tighten the screws in the order indicated.

Note: If you are replacing a processor heatsink with a new heatsink, do not reapply thermal grease. The new heatsink comes with thermal grease already in place, covered by a cap over the bottom of the heatsink. Before installing the heatsink, remove the cap.

Replacement Note: If you are replacing either the upper or lower processor heatsink with a new heatsink, apply the enclosed gasket to the top of the heatsink, as illustrated below.



Replacement Note: If you are replacing the lower processor (CPU B) heatsink with a new heatsink, install the enclosed bumpers on either side of the heatsink, as illustrated below. Do not add bumpers to the heatsink for the upper processor (CPU A).

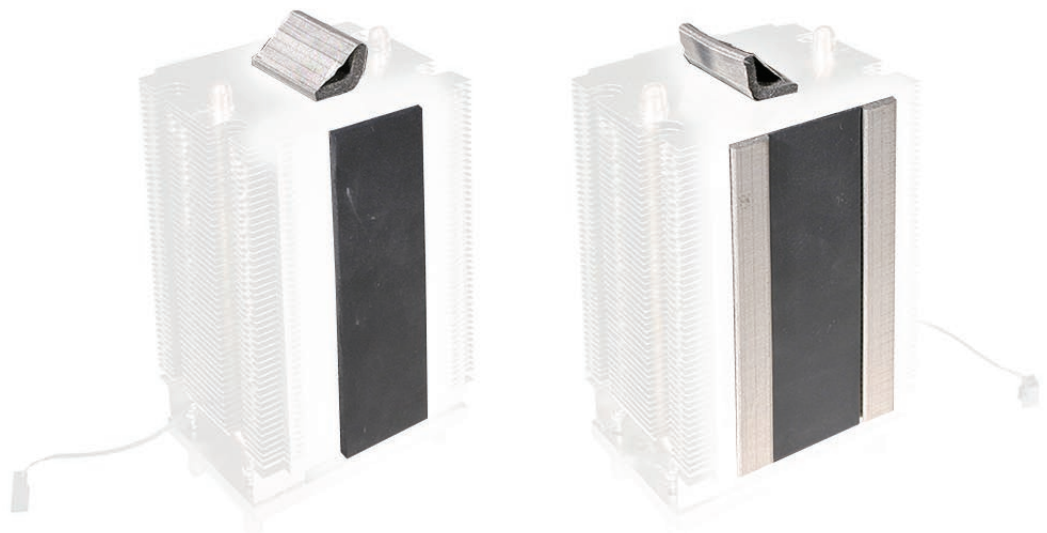



Memory Cage with Rear Fan

The rear fan is part of the memory cage assembly. If you need to replace the rear fan, you must replace the entire memory cage assembly.

Note: Every time you remove the memory cage, you must replace the thermal grease on the processor heatsinks. New grease and alcohol wipes for removing the previous grease are available as a separate kit (part number 076-1225). Instructions for applying the grease are included with the processor heatsinks procedure.

Tools

The only tools required for this procedure are pliers, wirecutters, and a socket wrench.

Preliminary Steps

Before you begin, open the computer, lay it on its side with the access side facing up, and remove the following:

- [Hard drives and hard drive carriers in drive bays 1 and 2](#)
- [PCI Express card installed in slot 1](#)
- [Any 12-inch PCI Express cards](#)
- [Top and bottom memory cards](#)
- [Processor heatsink cover](#)
- [Front fan assembly](#)
- [Processor heatsinks](#)

Part Location



Procedure

1. Disconnect the rear fan cable from the logic board.
2. Lift the memory cage out of the enclosure.

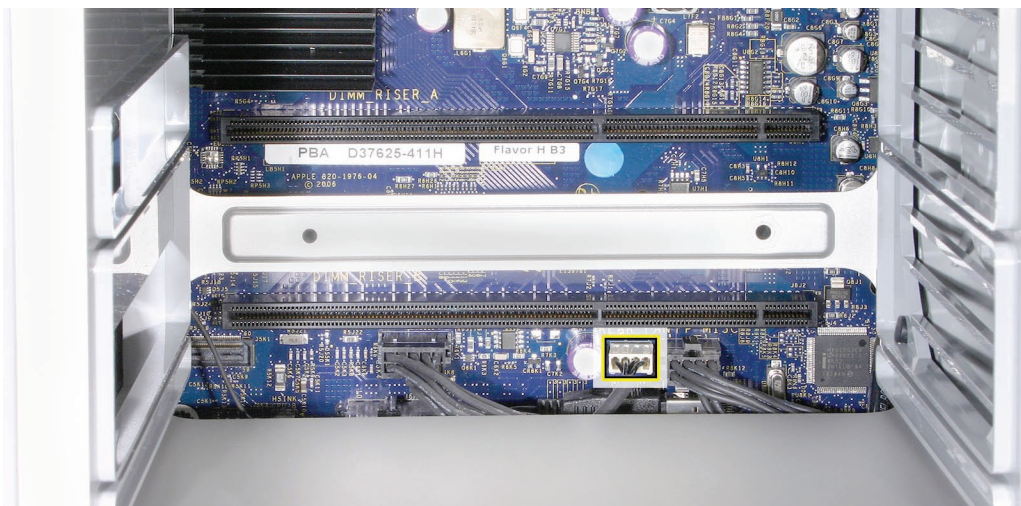

Replacement Note: When installing the memory cage, make sure all cables are out of the way so that the cage sits properly and the cable harness below it is not pinched or damaged when you tighten the screws.

Replacement Note for Cages with Stripped Screws: If either of the two short mounting screws for the memory cage stripped while you were attempting to take out the heatsink cover (see [step 2 in “Processor Heatsink Cover,”](#) the screw and hex standoff will stay attached to the memory cage when you remove it. In this case, before replacing the memory cage in the enclosure, do the following.

- Using pliers and a socket wrench, separate the hex standoff from the mounting screw.



- Replace the hex standoff in the enclosure.

Note: To avoid future problems, make sure both standoffs are securely fastened before you reinstall the memory cage.



Note: Order screw 922-7703 to replace any stripped, short screws used in securing the memory cage..



Processors

This procedure illustrates how to remove the lower processor (CPU B). The instructions are the same for removing the upper processor (CPU A). You may, however, want to use a flat-blade screwdriver to release the latch on the upper processor.

Note: Every time you remove a processor, you must replace the thermal grease on the processor heatsink. New grease and alcohol wipes for removing the previous grease are included with replacement processors. Instructions for applying the grease are included with the processor heatsinks procedure.

Identifying Version 1 and Version 2 Processors

There are two versions of the processor, Version 1 and Version 2, which must be replaced like-for-like. **In addition, both processors in a dual configuration must be the same version, either Version 1 or Version 2.** Different versions in the same computer could cause a system failure.

Note: You may still replace a single processor, but you must replace it like for like. There is no performance advantage to either version of the processor.

To identify the correct processor for the computer you are repairing, please check its configuration code (the last three alphanumeric characters in the serial number for the computer). The following table lists the configuration codes that use Version 2 processors; all other configuration codes use Version 1 processors. If you do not have the correct processor, please order it from GSX.

Configuration Code	Version 2 Processor
OKW, 0L0, 0L5, 0L7, 0LD, 0LE, 0LH, 0GP	2.0 GHz (661-4612)
OKT, 0GN, 0KY, 0KZ, 0L1, 0L2, 0L4, 0L6, 0L9, 0LA, 0LC, 0GP	2.66 GHz (661-4613)
OKV, 0KU, 0HA, 0KX, 0L3, 0L8, 0LB, 0LL, 0LM, 0LP, 0GP	3.0 GHz (661-4614)

Tools

No tools are required for this procedure. However, you may find a flat-blade screwdriver helpful in releasing the processor holder latch.

Preliminary Steps

Before you begin, open the computer, lay it on its side with the access side facing up, and remove the following:

- [Hard drives and hard drive carriers in drive bays 1 and 2](#)
- [PCI Express card installed in slot 1](#)
- [Any 12-inch PCI Express cards](#)
- [Top and bottom memory cards](#)
- [Processor heatsink cover](#)
- [Front fan assembly](#)
- [Processor heatsinks](#)
- [Memory cage](#)

Part Location

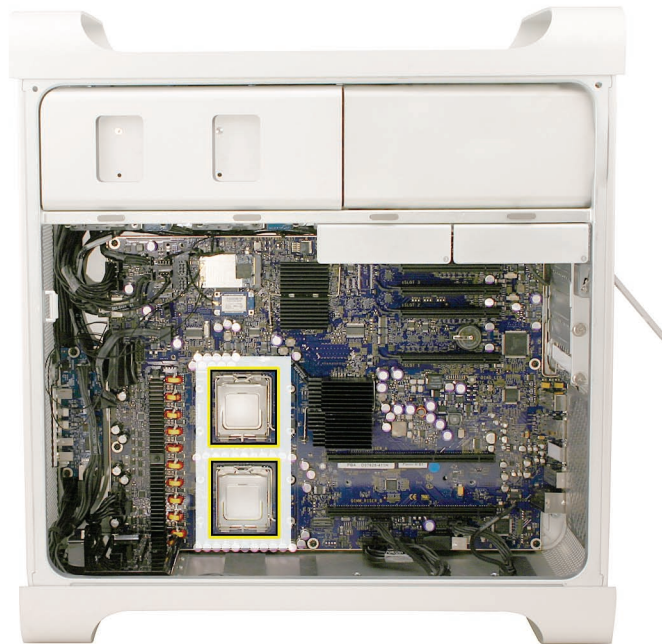

Procedure

1. Release the latch on the metal processor holder.

Note: You may want to use a flat-blade screwdriver to release the latch on the upper processor.



2. Rotate the top of the holder to the open position.

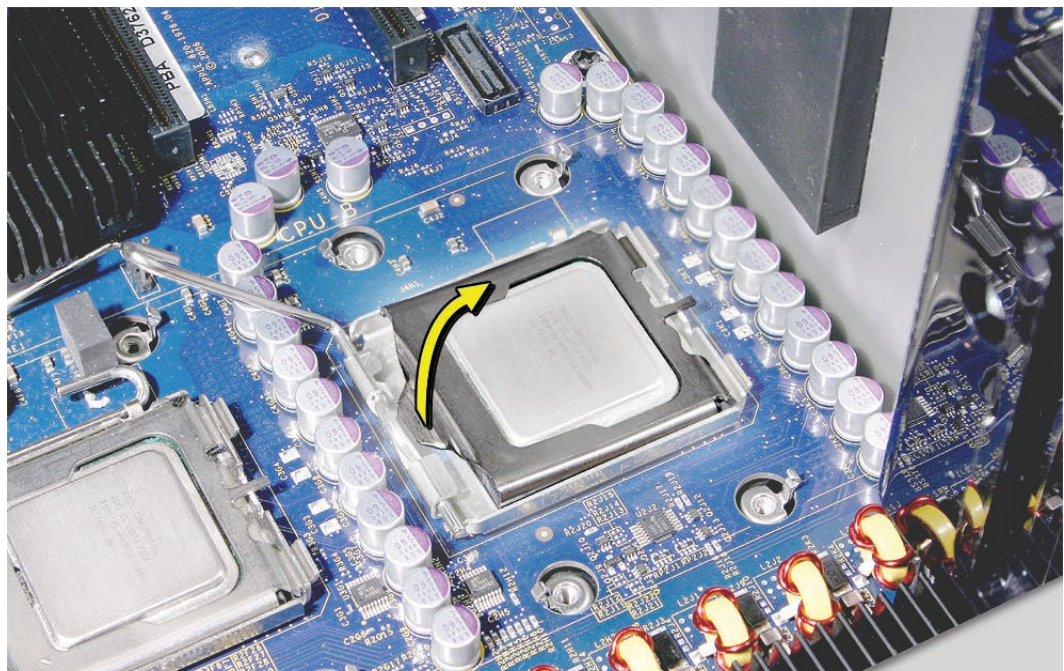

3. Lift the processor out of the holder.

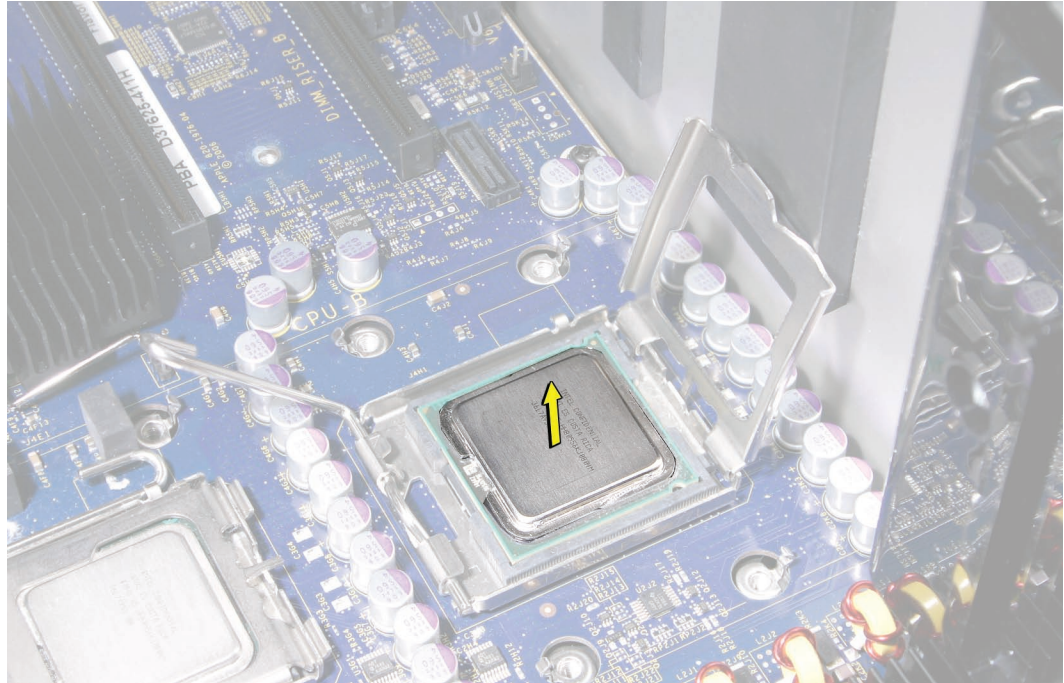

Important: When removing or installing a processor, always hold the processor by the edges. Be extremely careful not to touch the gold pins on the bottom of the processor, as this type of connector is very sensitive to contamination. Also be careful not to touch the gold pins in the processor socket on the logic board.

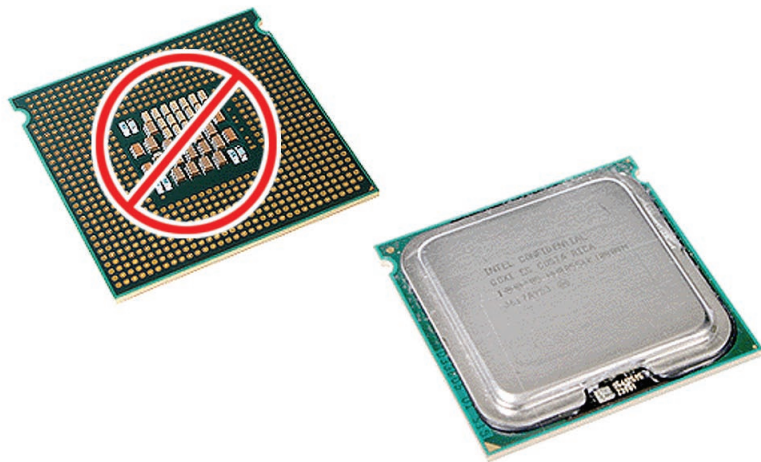

Note: You can identify the processor by the speed etched on the processor can, as illustrated below. You must clean off the thermal grease from installed processors to see the speed.



Replacement Note: Before installing a replacement processor, remove the protective cap covering the new processor's connector.



Replacement Note: When installing the processor on the logic board, align the processor notch with the tab on the processor holder, as illustrated. Then lower the processor straight down onto the socket.

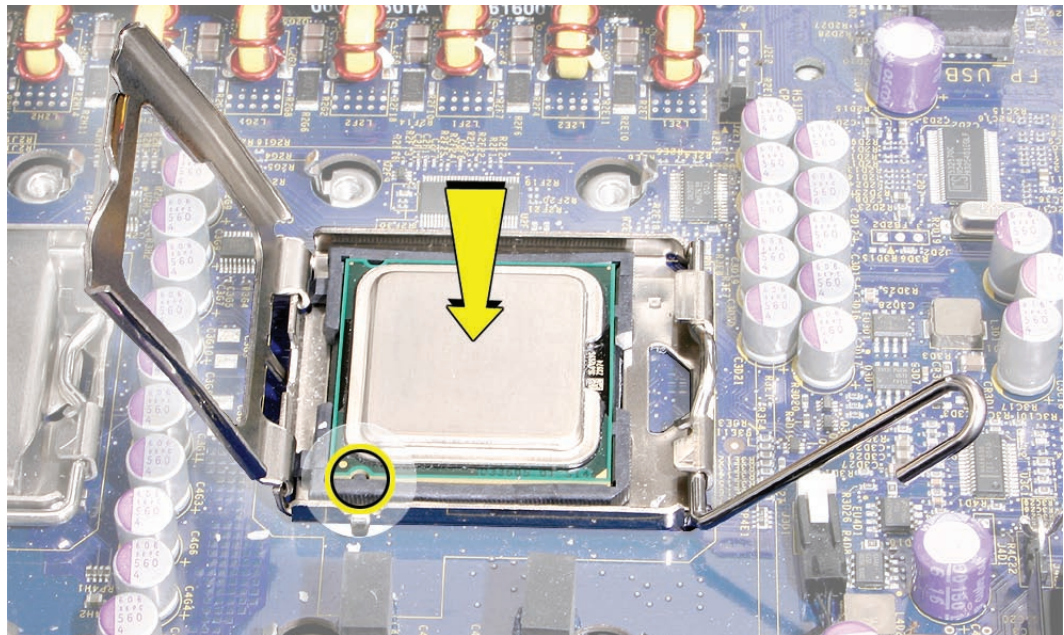

Replacement Note: Make sure the two logic board bumpers by the upper processor are in place before you reinstall the heatsinks.

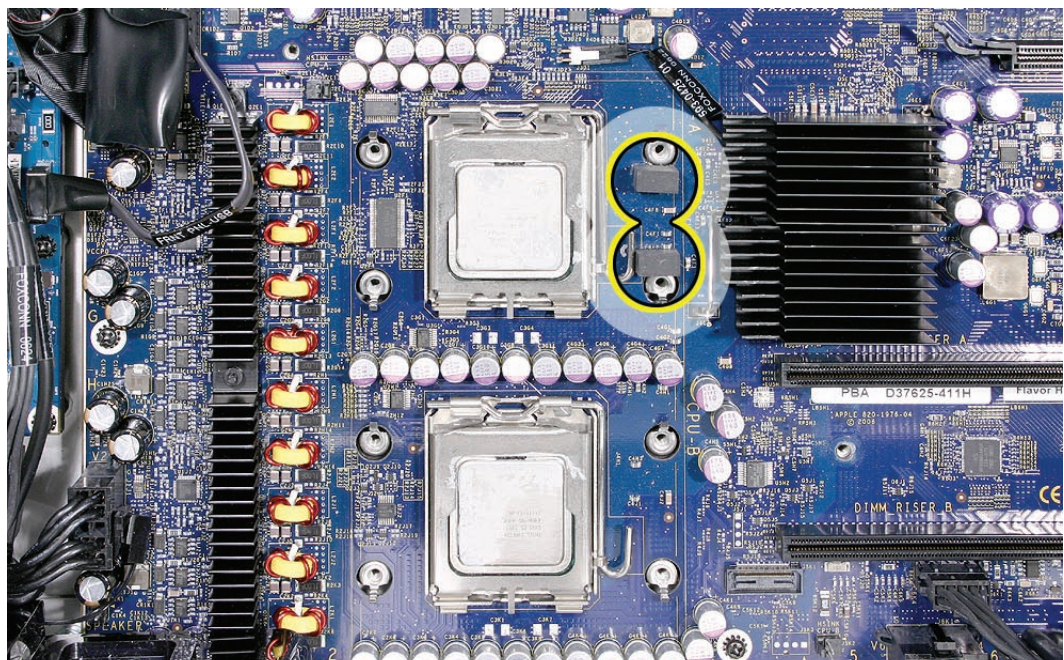

Note: Unlike in earlier Power Mac G5 computers, replacing a processor in Mac Pro does not require running Apple Service Diagnostic for thermal calibration..

Important: For the new processor to perform properly, the logic board must be upgraded to the latest version of the BootROM. You can download the latest version from the Apple support web site: <http://www.apple.com/support/downloads/>

Specifically, see [KnowledgeBase article 303880, "Firmware Updates for Intel-based Macs."](#)



Speaker Assembly

Tools

The only tools required for this procedure are a magnetized #1 Phillips screwdriver and a magnetized jeweler's #0 Phillips screwdriver.

Preliminary Steps

Before you begin, open the computer, lay it on its side with the access side facing up, and remove the following:

- [Hard drives and hard drive carriers in drive bays 1 and 2](#)
- [PCI Express card installed in slot 1](#)
- [Any 12-inch PCI Express cards](#)
- [Top and bottom memory cards](#)
- [Processor heatsink cover](#)
- [Front fan assembly](#)

Part Location

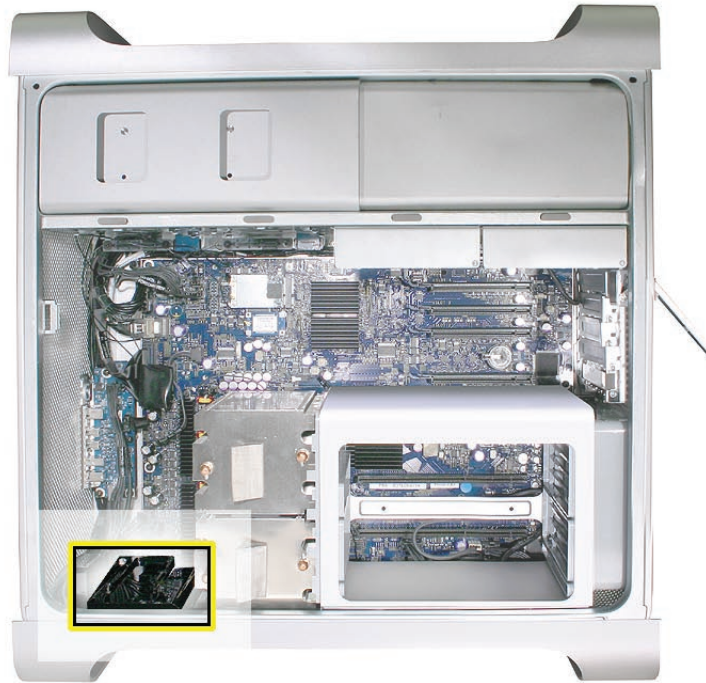

Procedure

1. Remove the three speaker assembly mounting screws.
2. Carefully pivot the speaker assembly a short distance away from the enclosure.



3. Disconnect the speaker assembly cable from the logic board.

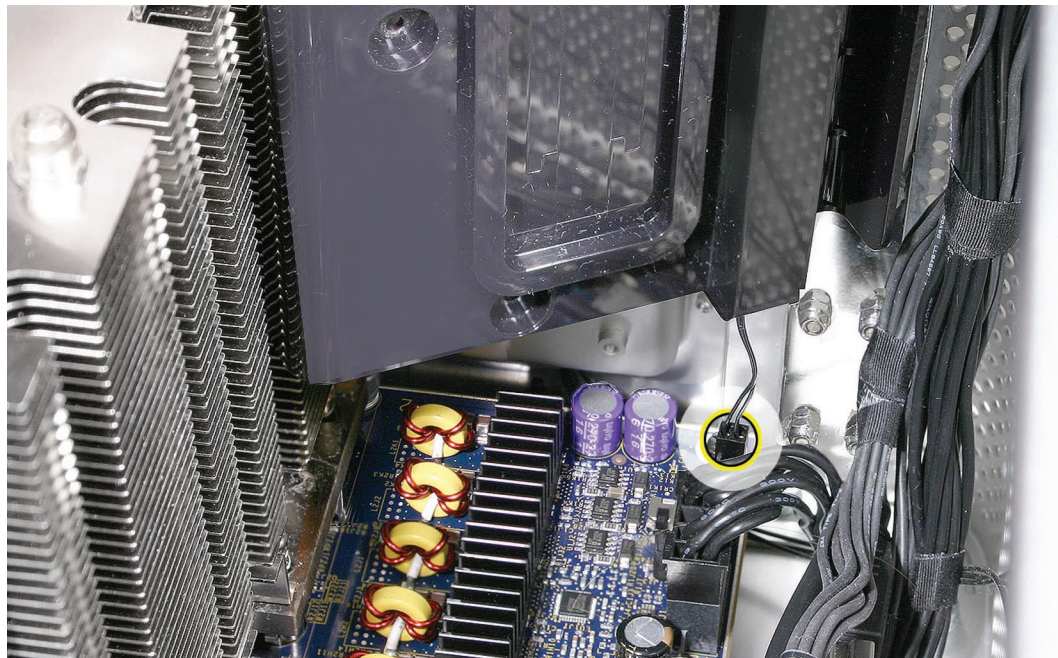

4. Remove the speaker assembly from the computer.

-
5. If you are replacing the speaker in the assembly bracket, do the following:
 - Slide the speaker cable through the opening in the speaker bracket.
 - Using a magnetized jeweler's #0 Phillips screwdriver, remove the four mounting screws.

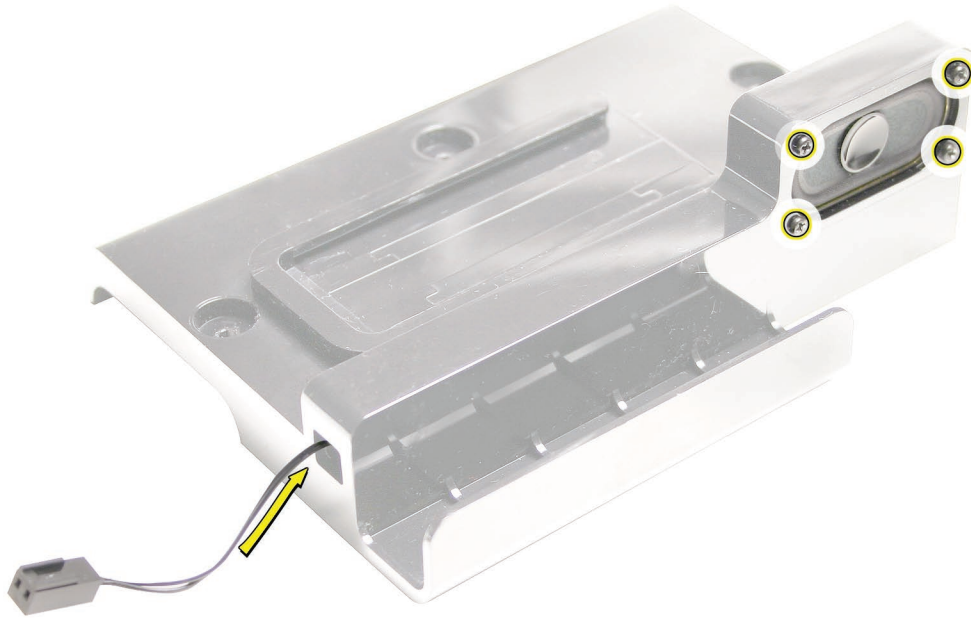

6. Remove the speaker and cable from the bracket.



USB Cable

Tools

No tools are required for this procedure.

Preliminary Steps

Before you begin, open the computer, lay it on its side with the access side facing up, and remove the following:

- [Hard drives and hard drive carriers in drive bays 1 and 2](#)
- [PCI Express card installed in slot 1](#)
- [Any 12-inch PCI Express cards](#)
- [Top and bottom memory cards](#)
- [Processor heatsink cover](#)
- [Front fan assembly](#)

Part Location

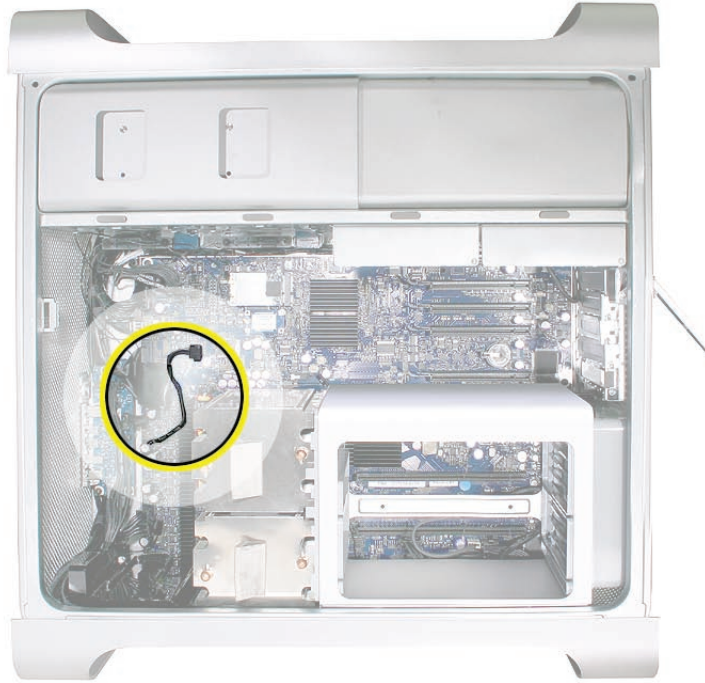

Procedure

1. Disconnect the USB cable from connector J201 on the front panel board.
2. Disconnect the USB cable from connector J2D1 on the logic board.

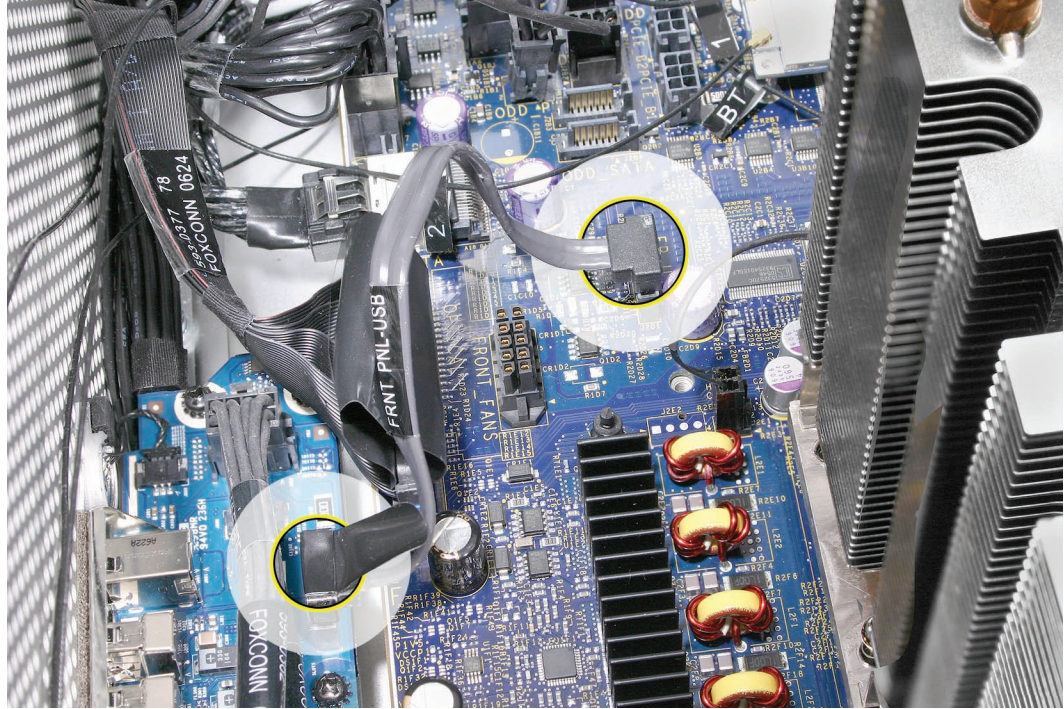

3. Remove the cable from the enclosure.



Logic Board

Note: Every time you remove the logic board, you must replace the thermal grease on the processor heatsinks. New grease and alcohol wipes for removing the previous grease are included with replacement logic boards. Instructions for applying the grease are included with the processor heatsinks procedure.

Tools

The only tool required for this procedure is a magnetized Phillips #1 screwdriver.

Preliminary Steps

Before you begin, open the computer, lay it on its side with the access side facing up, and remove the following:

- [All hard drives and hard drive carriers](#)
- [All PCI Express cards](#)
- [Top and bottom memory cards](#)
- [Processor heatsink cover](#)
- [Front fan assembly](#)
- [Processor heatsinks](#)
- [Memory cage](#)
- [Speaker assembly](#)
- [USB cable](#)
- [AirPort Extreme card \(if installed\)](#)
- [Bluetooth card \(if installed\)](#)

Part Location



Procedure

1. To keep them out of the way, temporarily tape the antenna cables to the bottom of the media shelf.

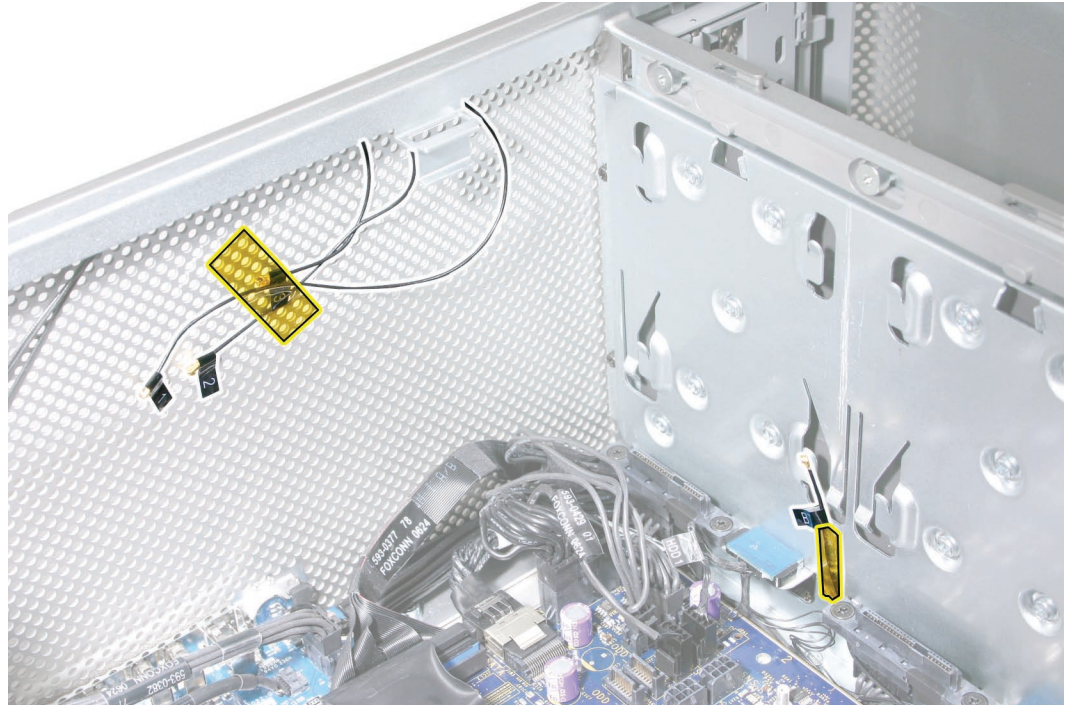

Important: Be sure to disconnect all cables from the logic board before you remove the logic board mounting screws.

2. Starting at the back panel side of the logic board and working clockwise around the board, disconnect all cables from the logic board.

Note: There are 14 cables you will be disconnecting from the logic board.

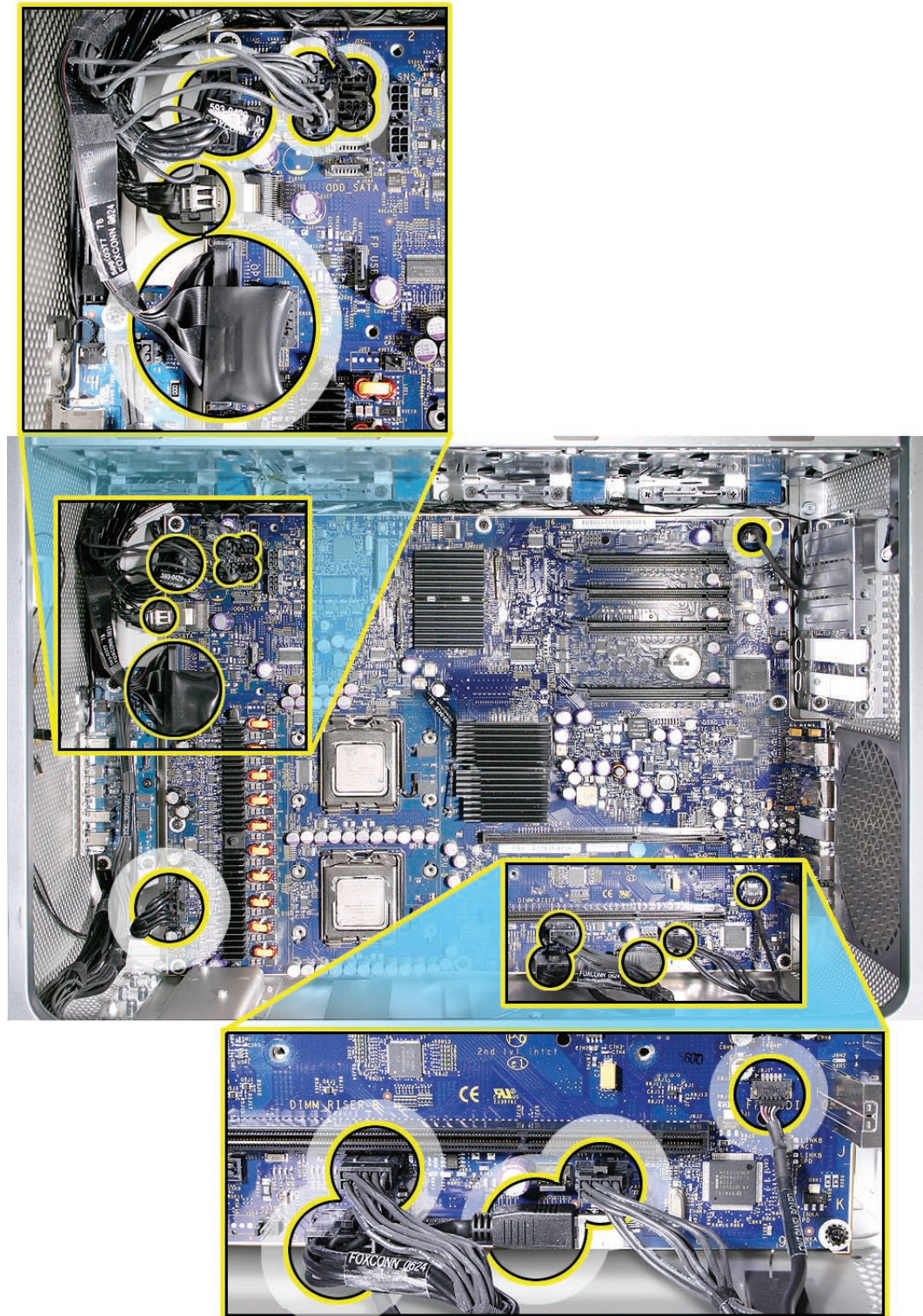

- Using a magnetized #1 Phillips screwdriver, remove the eight black logic board mounting screws.

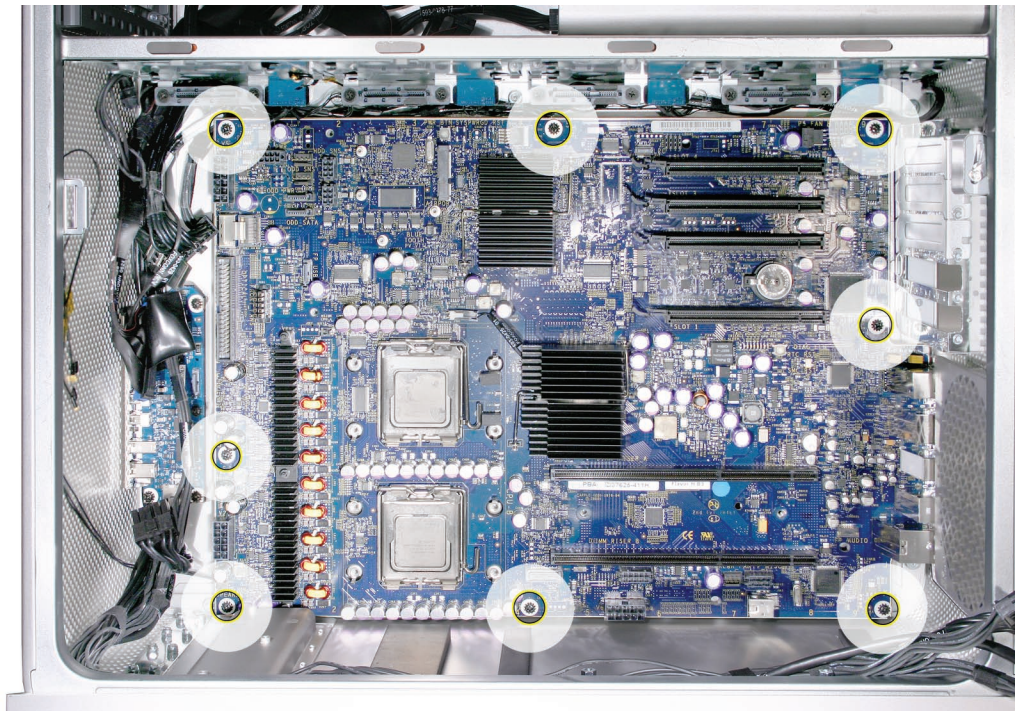

-
4. Slide the logic board back a short distance from the port openings in the back panel. Make sure the ports clear the openings.
 5. Tilt the top edge of the logic board up and maneuver the board out of the enclosure.



Replacement Note: Before replacing the logic board, check the underside of the board to be sure that all bumpers are in place. Replace any missing bumpers.

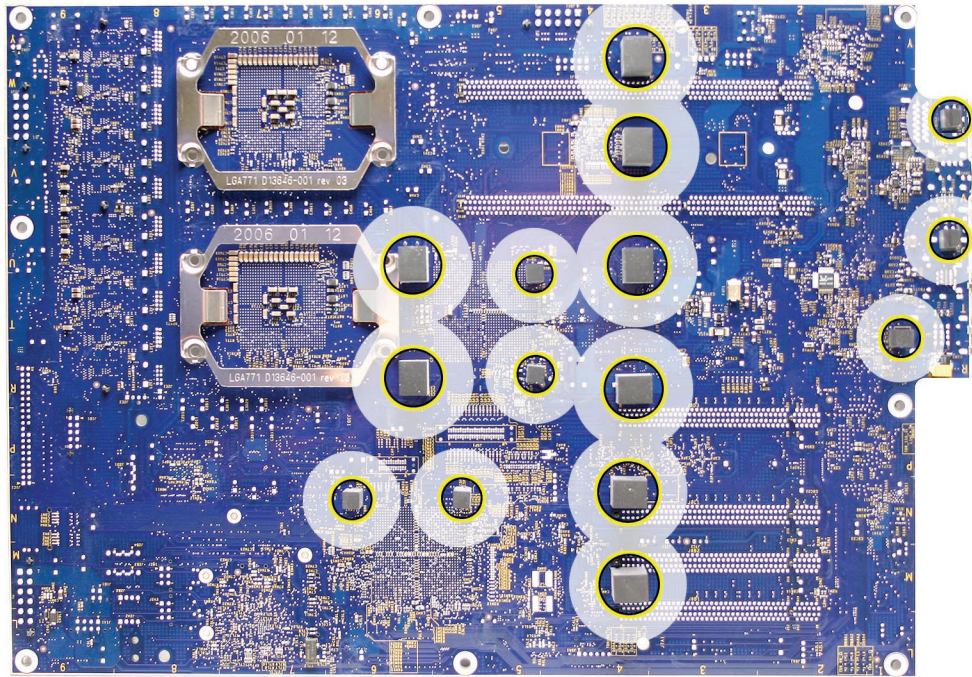

Replacement Note: Also check that the two bumpers are in place by the upper processor on the top side of the logic board. Replace any missing bumpers.

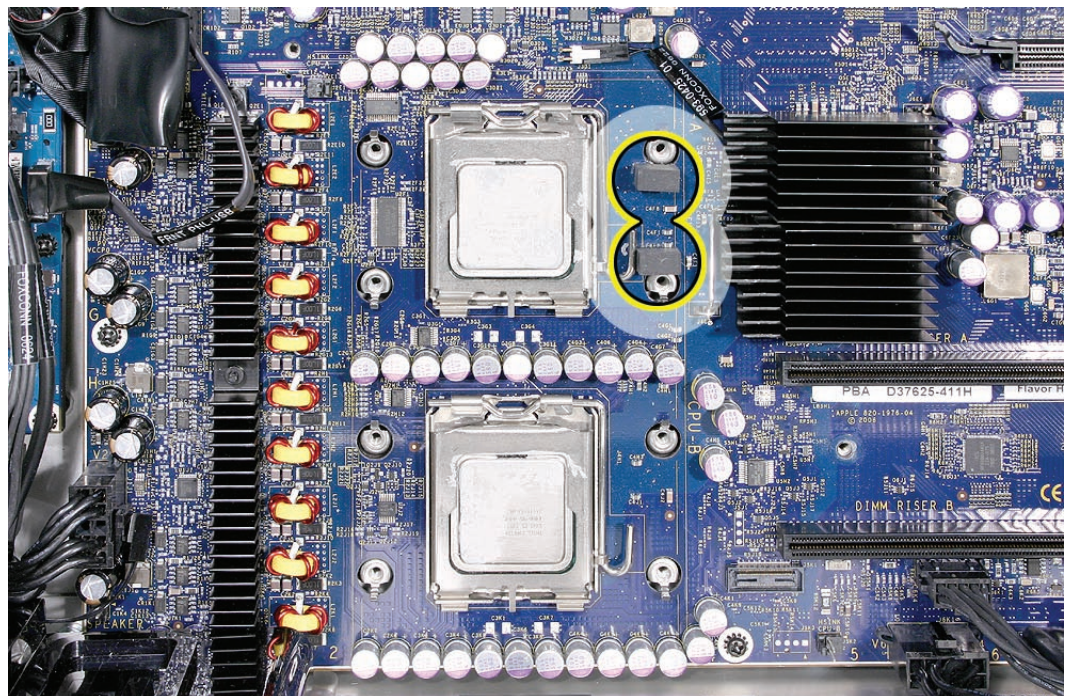

Replacement Note: If you are replacing the logic board with a new logic board, do the following:

- Remove the protective caps from the new logic board's processor holders and transfer the caps to the original logic board's processor holders. Note that logic boards returned to Apple without the protective caps may be rejected.

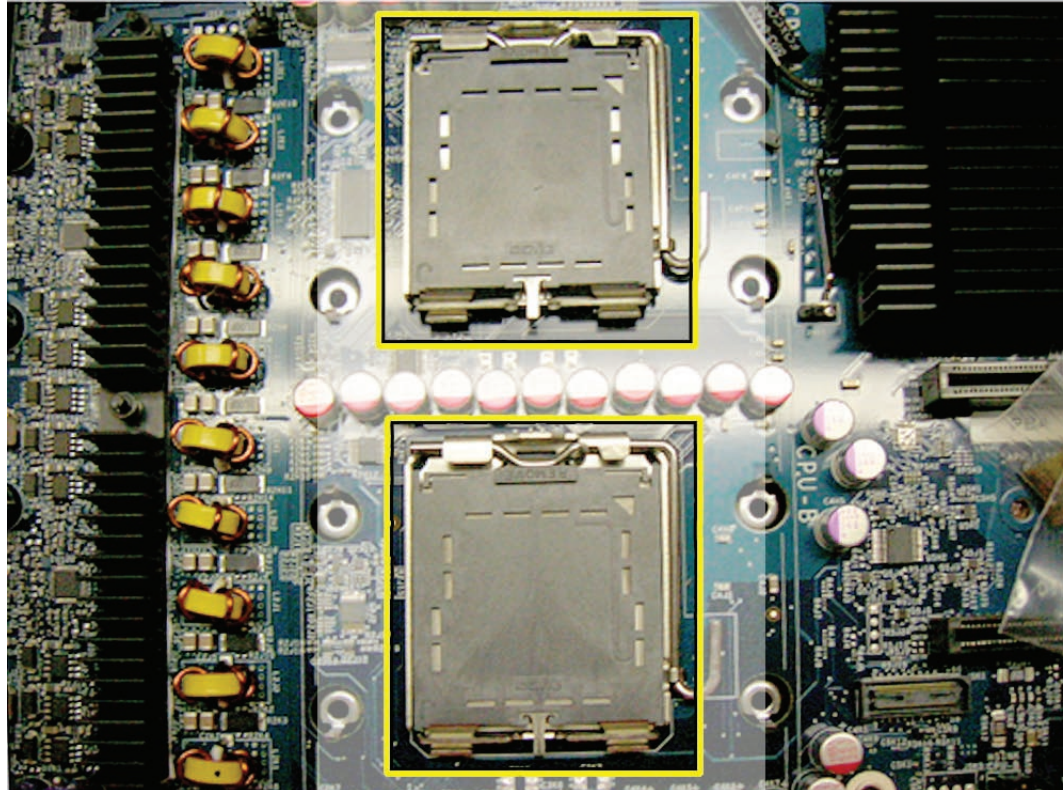

Warning: Be careful not to touch the gold pins in the processor socket on the logic board.

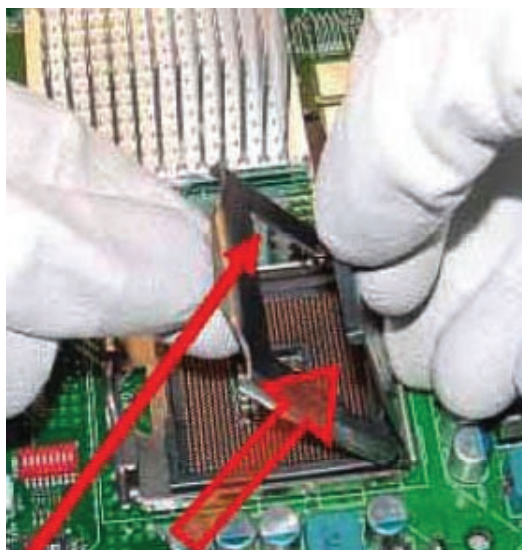

- Transfer the following to the new board:
 - Processors
 - DIMMs
 - PCI Express/graphics cards
 - AirPort Extreme card (if installed)
 - Bluetooth card (if installed)
- You must also transfer the back ports EMI shield to the new board.

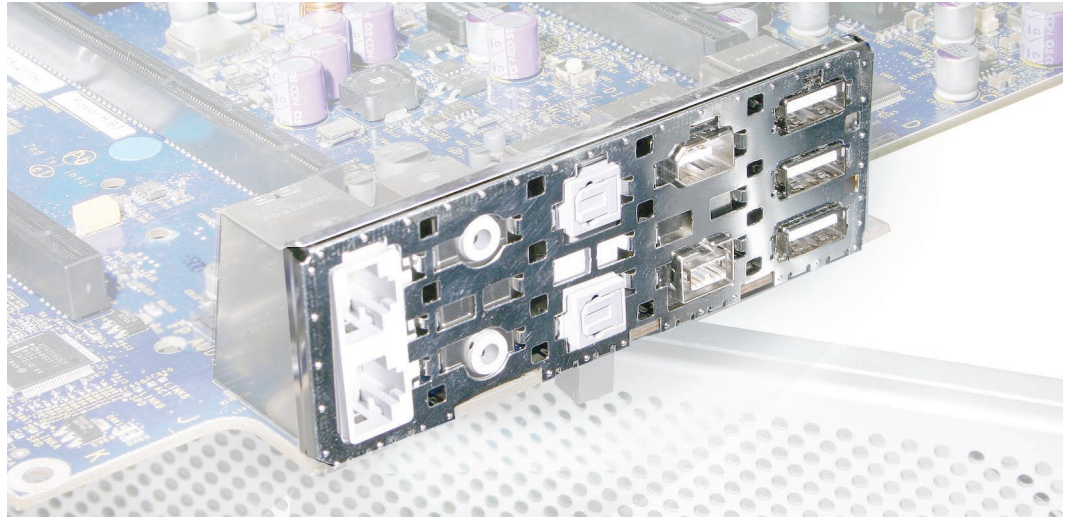

Replacement Note: To replace the logic board, tilt the board as illustrated and lower it into the enclosure.



Note: Unlike in earlier Power Mac G5 computers, replacing a logic board in Mac Pro does not require running Apple Service Diagnostic for thermal calibration.

Important: For proper performance, all logic boards in Intel-based desktop computers and servers must be upgraded to the latest version of the BootROM. You can download the latest version from the Apple support web site:

<http://www.apple.com/support/downloads/>



Front Panel Board

Tools

The only tool required for this procedure is a long-handled, magnetized Phillips #1 screwdriver.

Preliminary Steps

Before you begin, open the computer, lay it on its side with the access side facing up, and remove the following:

- [Hard drives and hard drive carriers in drive bays 1 and 2](#)
- [PCI Express card installed in slot 1](#)
- [Any 12-inch PCI Express cards](#)
- [Top and bottom memory cards](#)
- [Processor heatsink cover](#)
- [Front fan assembly](#)

Part Location



Procedure

1. Disconnect the optical drive ribbon cable from the logic board and move the cable out of the way.

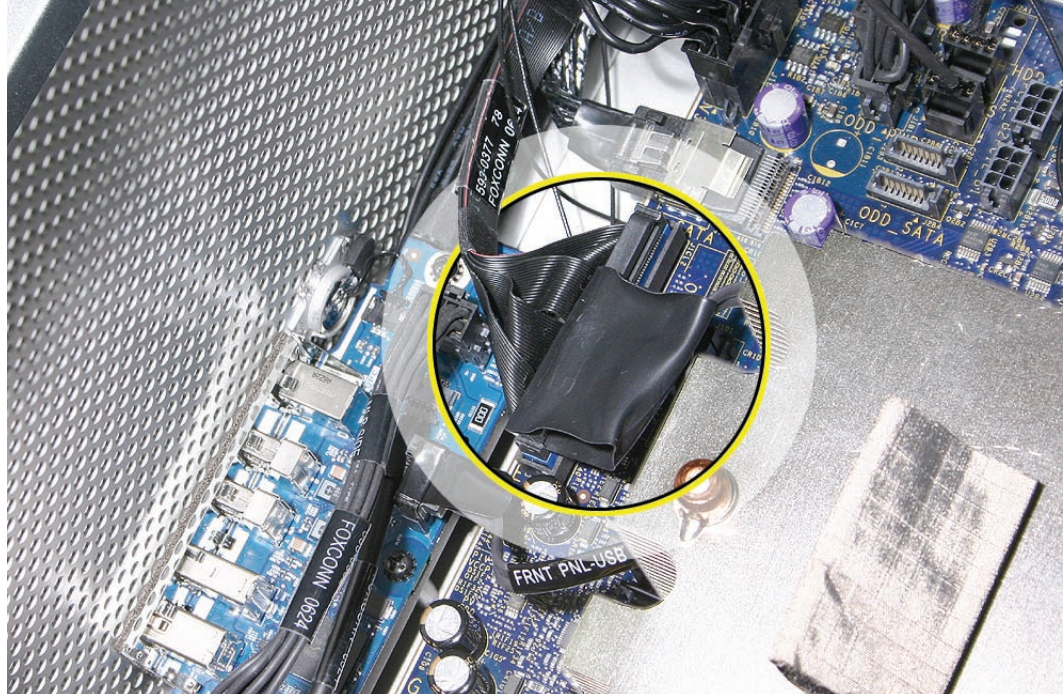

2. Disconnect the following five cables from the front panel board:
 - FireWire 800 cable from connector J200
 - USB cable from connector J201
 - Front panel board power cable from connector J202
 - Front panel board audio cable from connector J600
 - Power button cable from connector J800

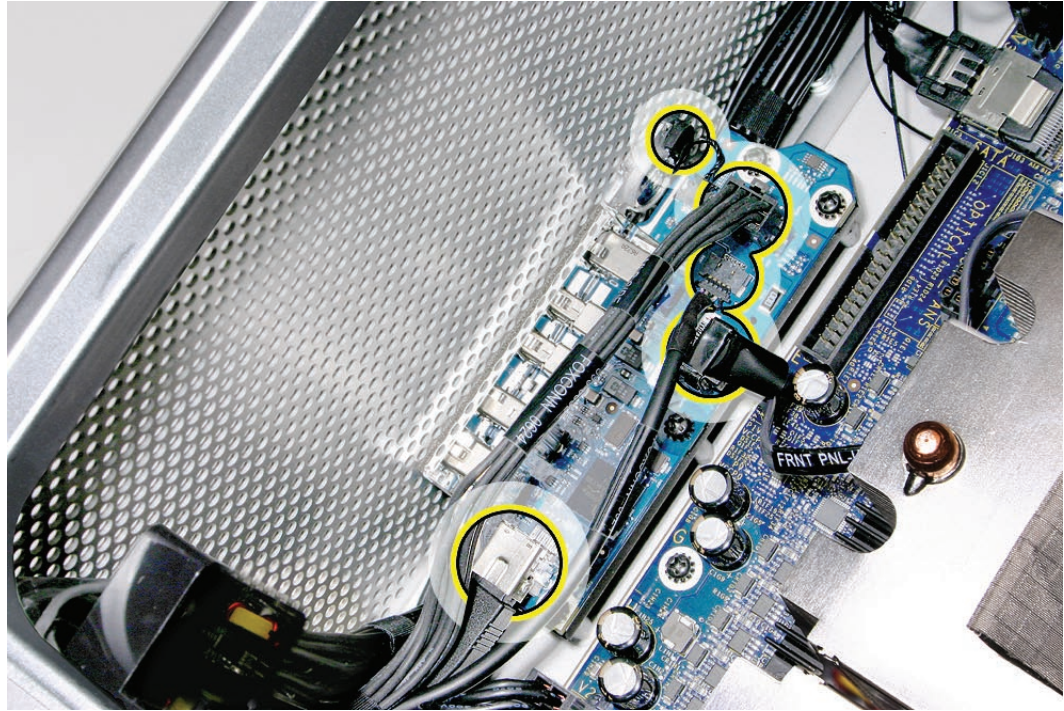

- Using a magnetized #1 Phillips screwdriver, remove the five front panel board mounting screws.

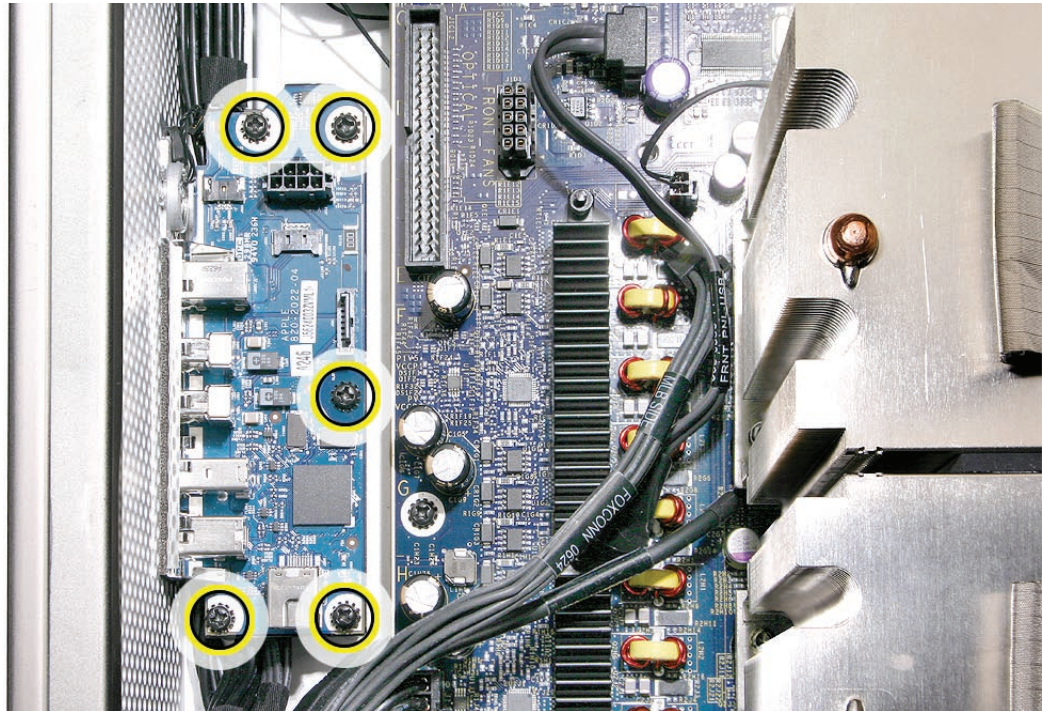

- Lift the front panel board out of the computer.

Note: If you are replacing the front panel board with a new front panel board, separate the EMI shield from the back of the board and transfer it to the new front panel board.





Power Button

Tools

The only tool required for this procedure is a jeweler's flat-blade screwdriver.

Preliminary Steps

Before you begin, open the computer, lay it on its side with the access side facing up, and remove the following:

- [Hard drives and hard drive carriers in drive bays 1 and 2](#)
- [PCI Express card installed in slot 1](#)
- [Any 12-inch PCI Express cards](#)
- [Top and bottom memory cards](#)
- [Processor heatsink cover](#)
- [Front fan assembly](#)

Part Location



Procedure

1. Disconnect the optical drive ribbon cable from the logic board and move the cable out of the way.
2. Disconnect the front panel board power cable from the front panel board and move it out of the way.
3. Disconnect the power button cable from the front panel board.

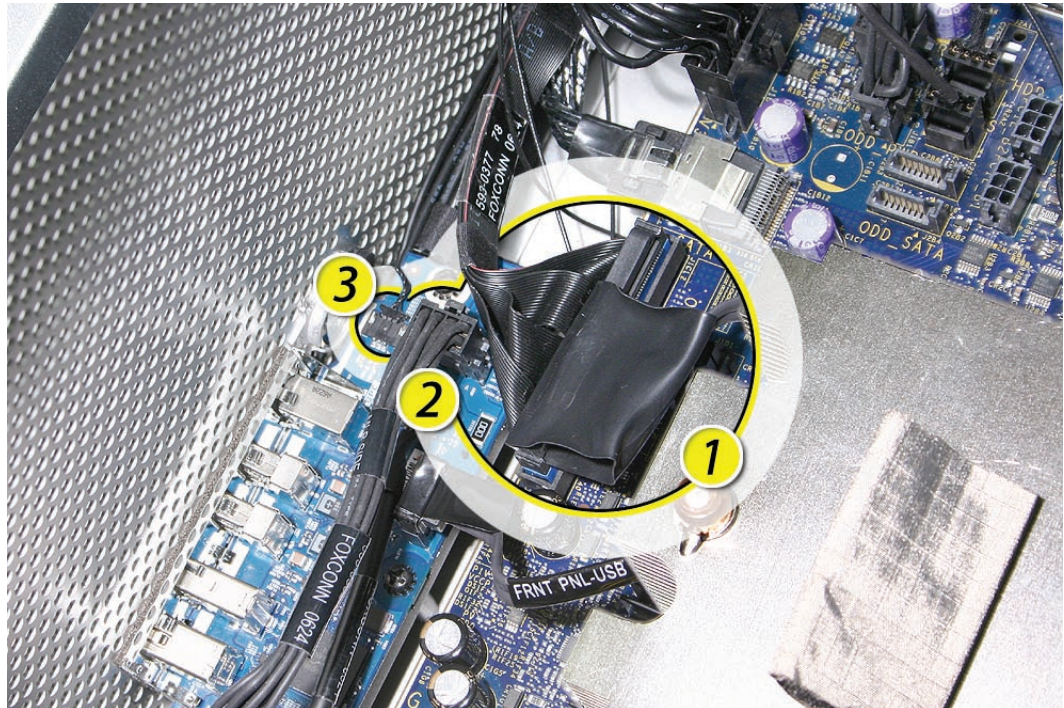

4. Lay the computer so that the front panel is facing down.

5. Remove the black rubber cap that covers the power button LED.
6. Using a jeweler's flat-blade screwdriver, pry up the metal C-ring that secures the power button board.

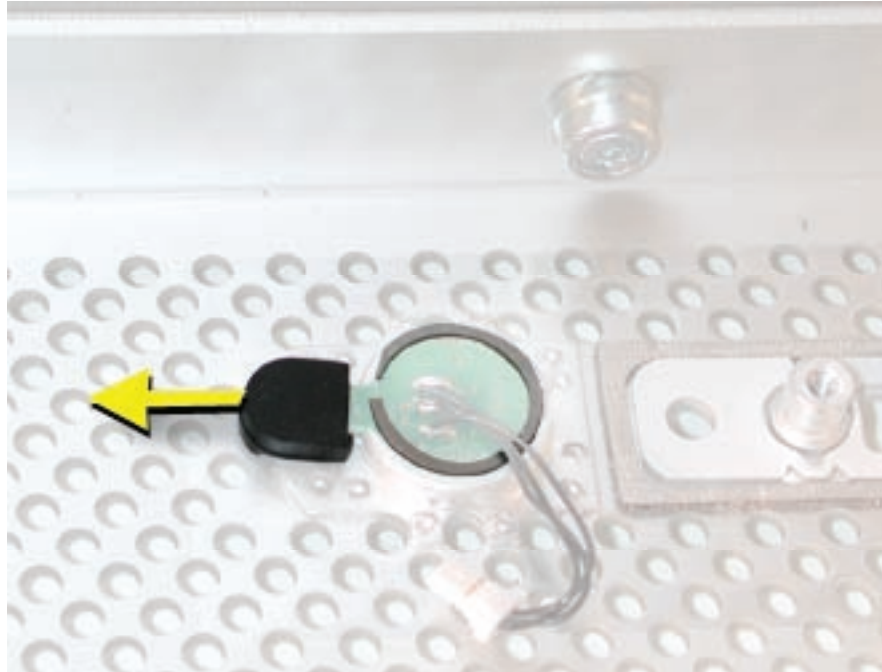

7. Lift up and remove the power button board.

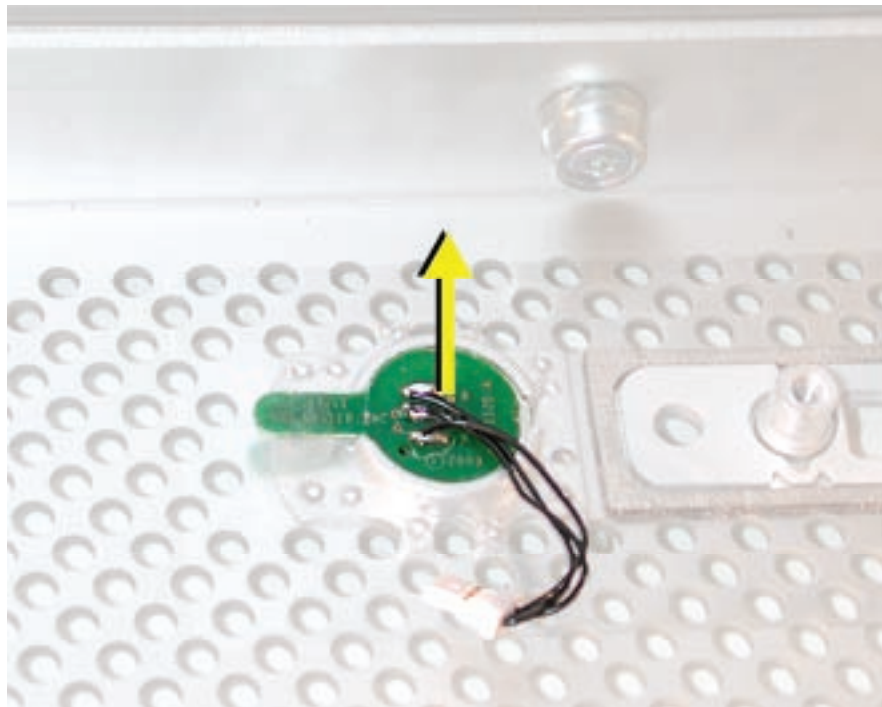

-
8. Remove the metal activation ring that lies below the power button board.

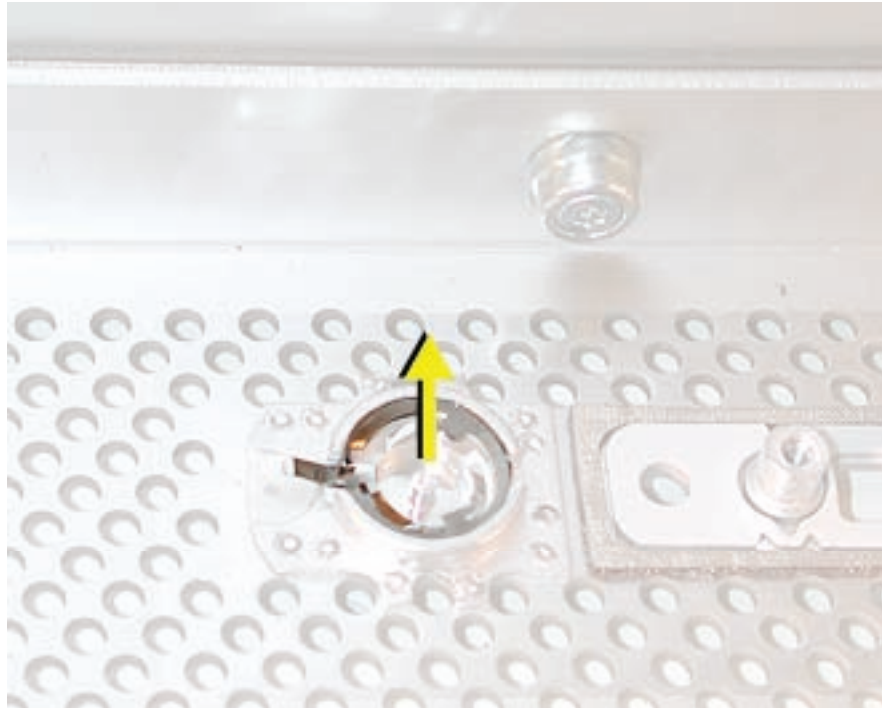

9. Remove the power button from the enclosure.

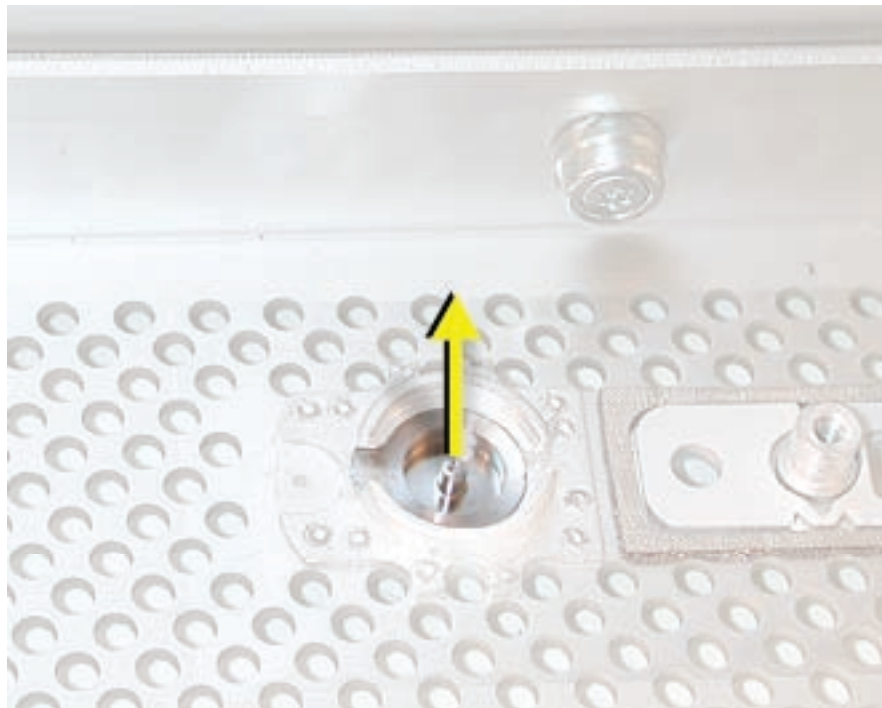



AirPort Antenna Board with Cables

The AirPort Extreme antenna cables are part of the AirPort antenna board assembly. To remove or replace the cables, you must replace the antenna board assembly.

Tools

The only tools required for this procedure are a jeweler's flat-blade screwdriver and a magnetized jeweler's Phillips #0 screwdriver.

Preliminary Steps

Before you begin, open the computer, lay it on its side with the access side facing up, and remove the following:

- [All hard drives and hard drive carriers](#)
- [All PCI Express cards](#)
- [Top and bottom memory cards](#)
- [Processor heatsink cover](#)
- [Front fan assembly](#)
- [Processor heatsinks](#)
- [Memory cage](#)
- [Speaker assembly](#)
- [USB cable](#)
- [AirPort Extreme card \(if installed\)](#)
- [Bluetooth card \(if installed\)](#)
- [Logic board](#)

Part Location

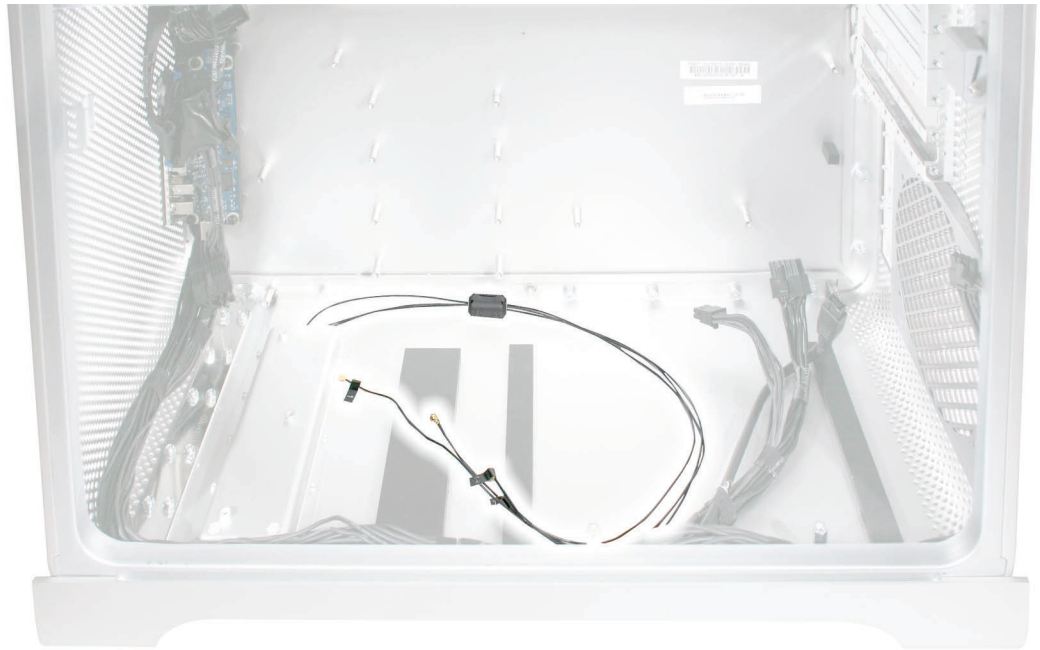

Procedure

1. Place the computer so that the bottom panel is facing you.
2. Using a jeweler's flat-blade screwdriver, pry open the two latches on the antenna wire ferrite bead and remove the bead from the wires.



- Using the jeweler's flat-blade screwdriver, carefully pry up the rectangular plastic plate on the bottom panel.



- Using a jeweler's #0 Phillips screwdriver, remove the four antenna board mounting screws.

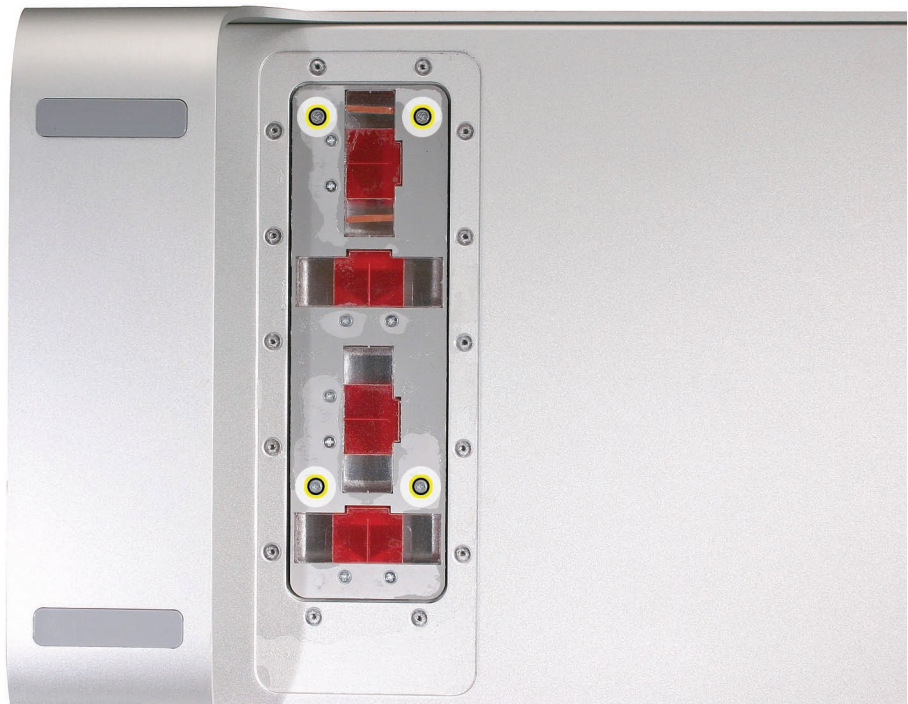

-
5. Tilt the antenna board away from the back panel a short distance.
 6. Feed each antenna wire separately out through the small opening in the bottom panel.

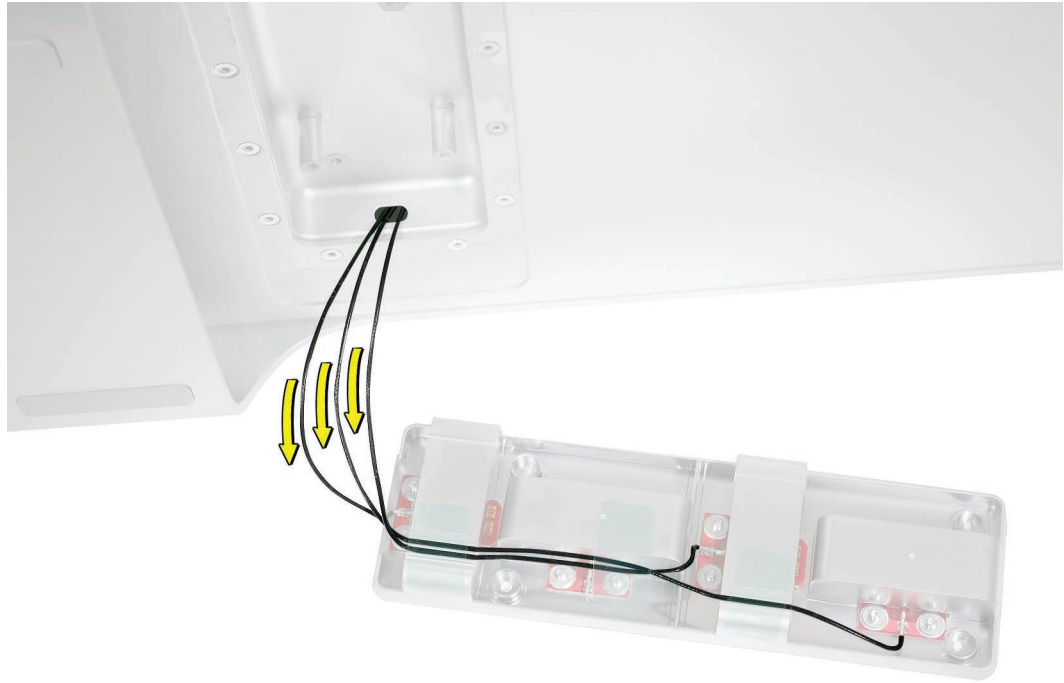

7. Remove the antenna board and cables from the enclosure.



Optical Drive Power Cable

Tools

The only tool required for this procedure is a magnetized #1 Phillips screwdriver.

Preliminary Steps

Before you begin, open the computer, lay it on its side with the access side facing up, and remove the following:

- [Optical drive carrier and optical drives](#)
- [Hard drives and hard drive carriers in drive bays 1 and 2](#)
- [PCI Express card installed in slot 1](#)
- [Any 12-inch PCI Express cards](#)
- [Top and bottom memory cards](#)
- [Processor heatsink cover](#)
- [Front fan assembly](#)

Part Location



Procedure

1. Using a magnetized #1 Phillips screwdriver, remove the two mounting screws on the hard drive connector for drive bay 1 and move the connector out of the way.

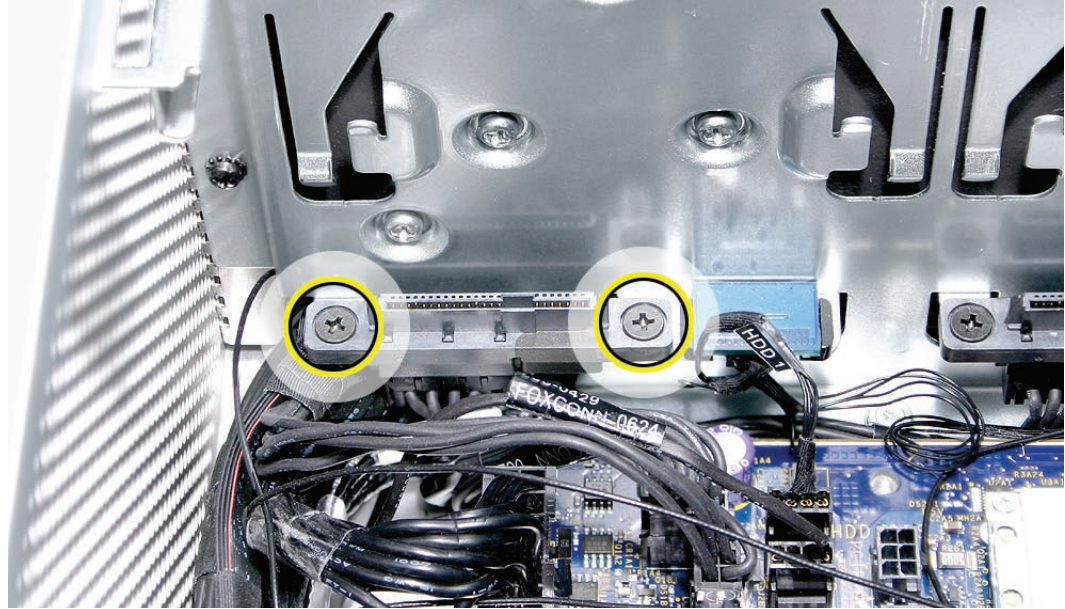

2. Unwind the tape that holds the optical drive data cable to the optical drive power cable.
3. Disconnect the optical drive power cable from the logic board.
4. Insert the logic board end of the power cable into the opening in the media shelf at hard drive bay 1 and remove the cable from the enclosure.

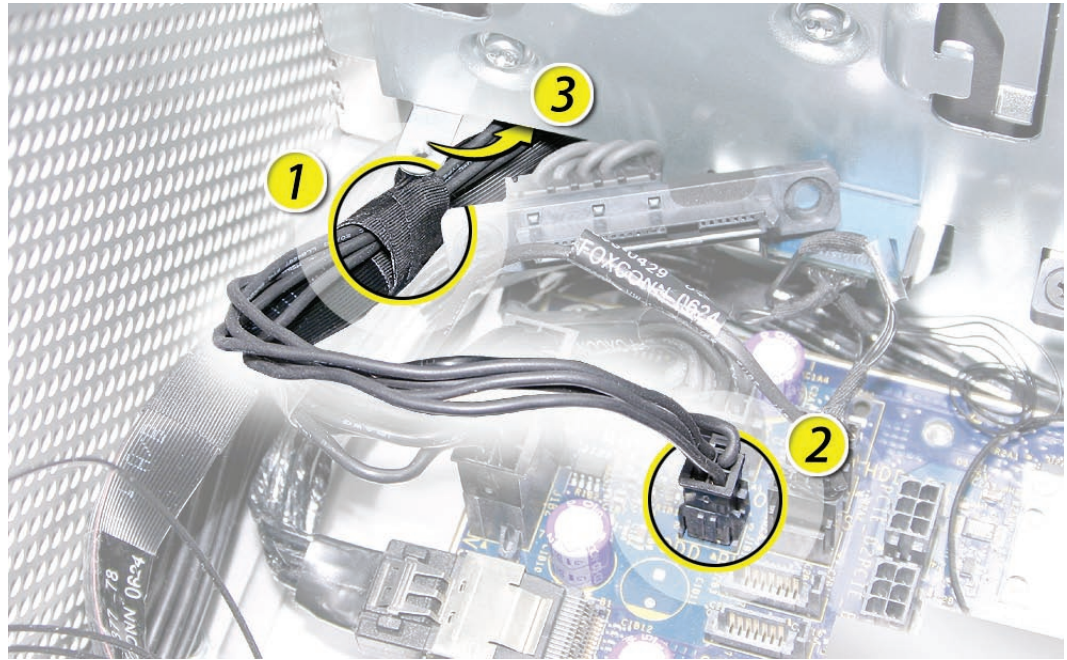



Optical Drive Data (Ribbon) Cable

Tools

The only tool required for this procedure is a magnetized #1 Phillips screwdriver.

Preliminary Steps

Before you begin, open the computer, lay it on its side with the access side facing up, and remove the following:

- [Optical drive carrier and optical drives](#)
- [Hard drives and hard drive carriers in drive bays 1 and 2](#)
- [PCI Express card installed in slot 1](#)
- [Any 12-inch PCI Express cards](#)
- [Top and bottom memory cards](#)
- [Processor heatsink cover](#)
- [Front fan assembly](#)

Part Location



Procedure

1. Using a magnetized #1 Phillips screwdriver, remove the two mounting screws on the hard drive connector for drive bay 1 and move the connector out of the way.

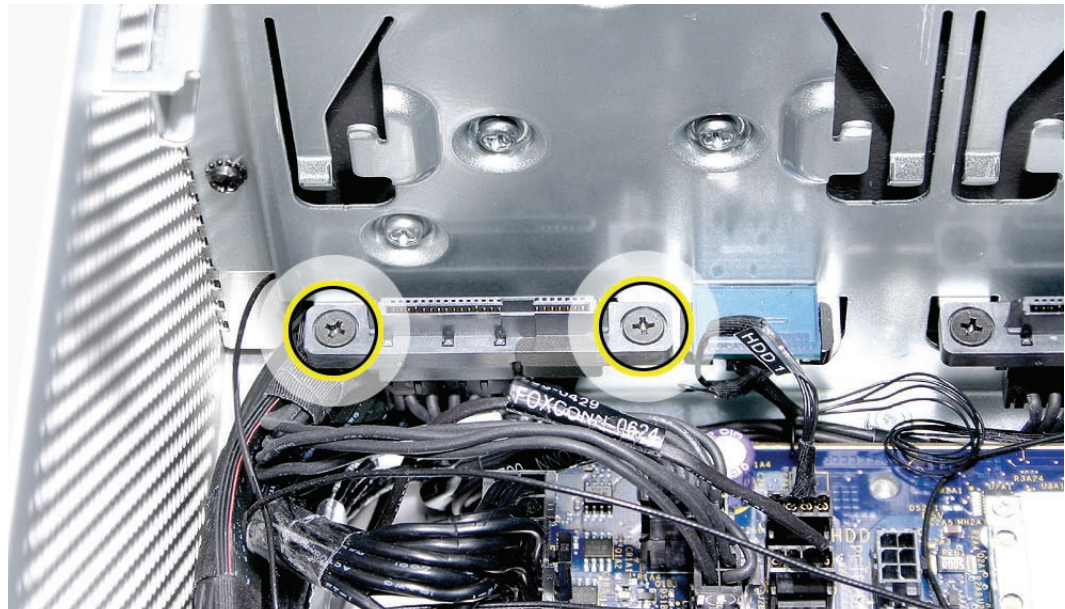

2. Unwind the tape that holds the optical drive data cable to the optical drive power cable.
3. Disconnect the optical drive data cable from the logic board.
4. Insert the cable into the opening in the media shelf at hard drive bay 1 and remove the cable from the enclosure.

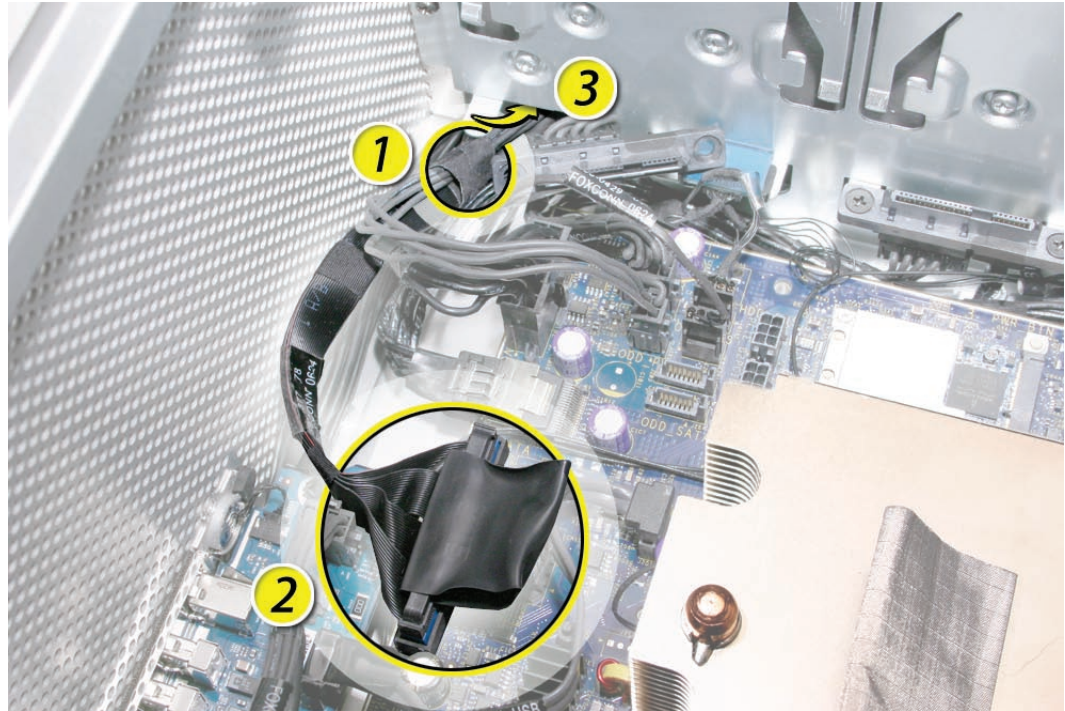



Ambient Board

Note: The ambient board is attached to the enclosure with adhesive. Once you remove the ambient board, you may have to apply new adhesive before reattaching the same ambient board. Replacement ambient boards come with adhesive already in place.

Tools

The only tools required for this procedure are a jeweler's flat-blade screwdriver.

Preliminary Steps

Before you begin, open the computer, lay it on its side with the access side facing up, and remove the [optical drive carrier and optical drives](#).

Part Location

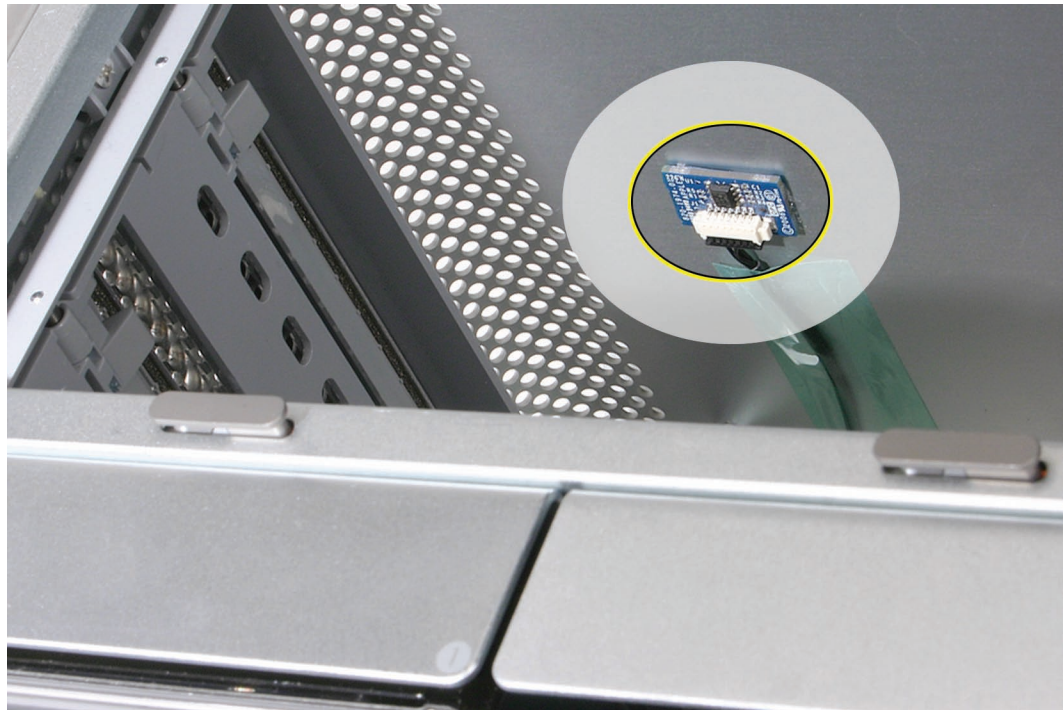

Procedure

1. Locate the ambient board on the inside left corner of the top panel, above the optical drive carrier.



2. Disconnect the ambient board cable from the ambient board.
3. Using a jeweler's flat-blade screwdriver, carefully pry the board from the enclosure.



Important: After you replace the ambient board, you must reset the System Management Controller. Refer to [“Resetting the Logic Board”](#) in the Troubleshooting chapter.



Ambient Board Cable

Tools

The only tool required for this procedure is a magnetized #1 Phillips screwdriver.

Preliminary Steps

Before you begin, open the computer, lay it on its side with the access side facing up, and remove the following:

- [Optical drive carrier and optical drives](#)
- [Hard drives and hard drive carriers in drive bays 1 and 2](#)
- [PCI Express card installed in slot 1](#)
- [Any 12-inch PCI Express cards](#)
- [Top and bottom memory cards](#)
- [Processor heatsink cover](#)
- [Front fan assembly](#)

Part Location

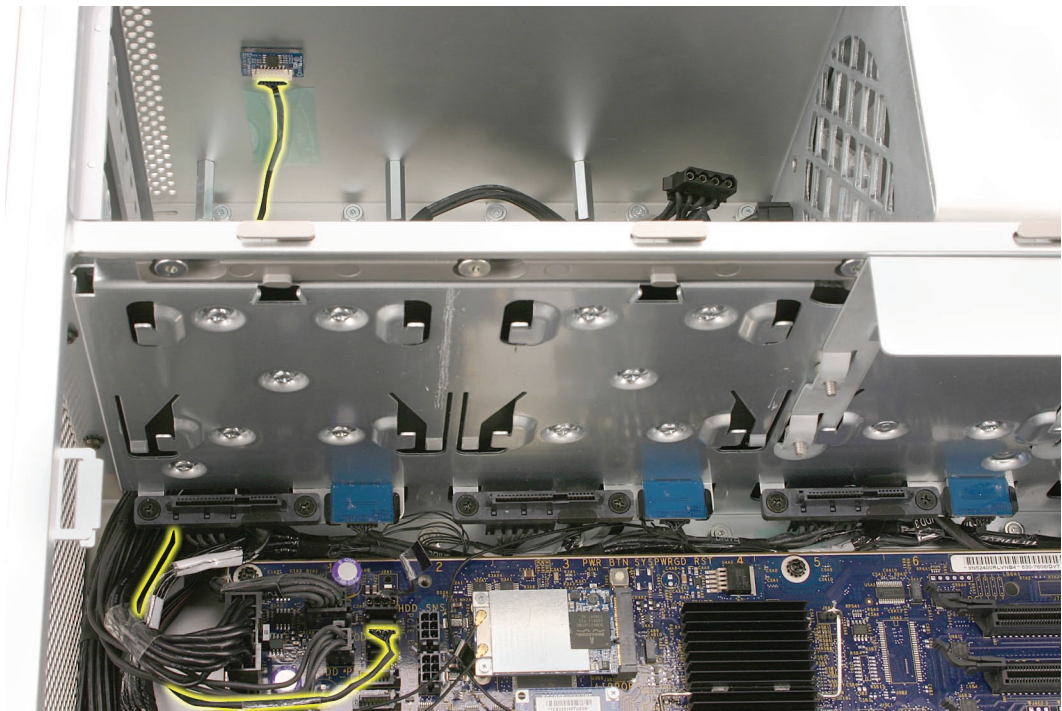

Procedure

1. Remove any tape holding the ambient board cable to the enclosure.
2. Disconnect the ambient board cable from the ambient board and logic board.

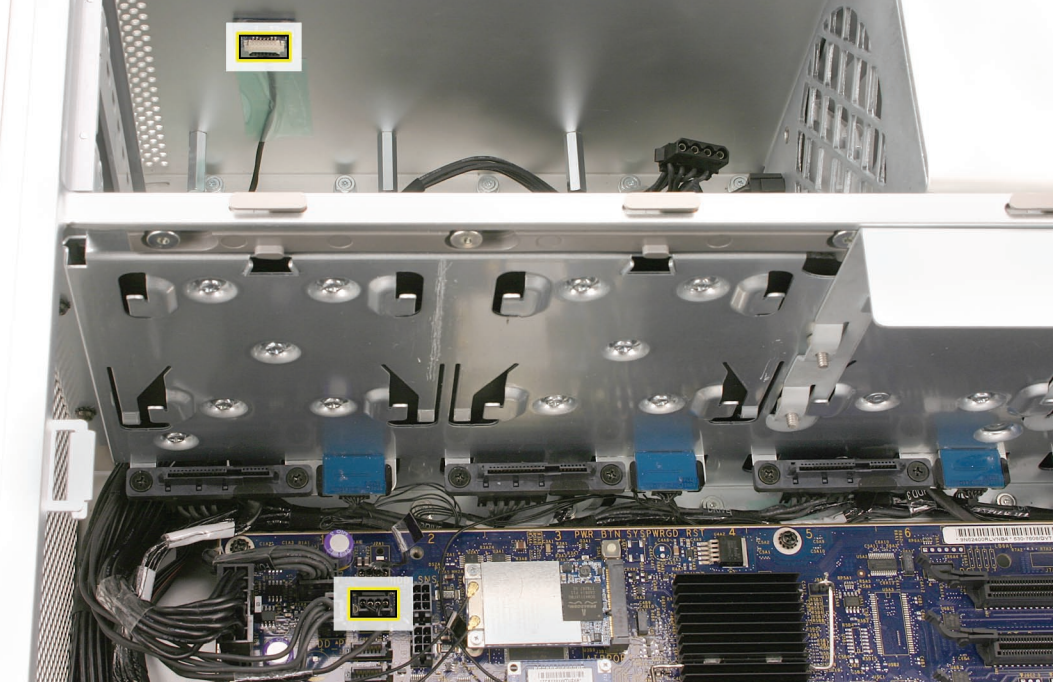

3. Using a magnetized #1 Phillips screwdriver, remove the two mounting screws on the hard drive connector for drive bay 1 and move the connector out of the way.

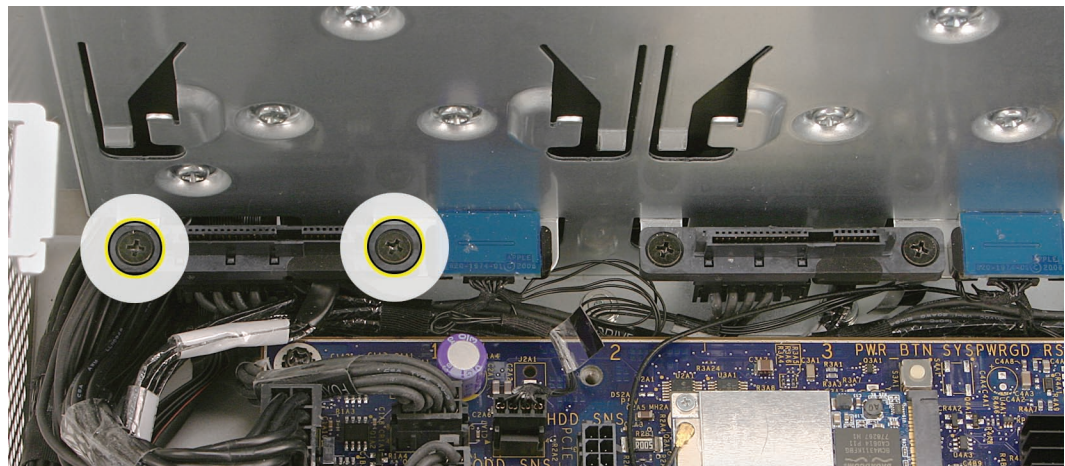

4. Route the ambient board cable out through the opening in the media shelf and remove the cable from the enclosure.

Important: After you replace the ambient board cable, you must reset the System Management Controller. Refer to [Resetting the Logic Board](#) in the Troubleshooting chapter.



Bluetooth Antenna Board and Cable

The Bluetooth antenna cable is part of the Bluetooth antenna board assembly. To remove or replace the cable, you must replace the antenna board assembly.

Tools

The only tool required for this procedure is a jeweler's flat-blade screwdriver.

Preliminary Steps

Before you begin, open the computer, lay it on its side with the access side facing up, and remove the following:

- [Hard drives and hard drive carriers in drive bays 1 and 2](#)
- [PCI Express card installed in slot 1](#)
- [Any 12-inch PCI Express cards](#)
- [Top and bottom memory cards](#)
- [Processor heatsink cover](#)
- [Front fan assembly](#)
- [Bluetooth card](#)
- [Processor heatsinks](#)
- [Memory cage](#)

Part Location

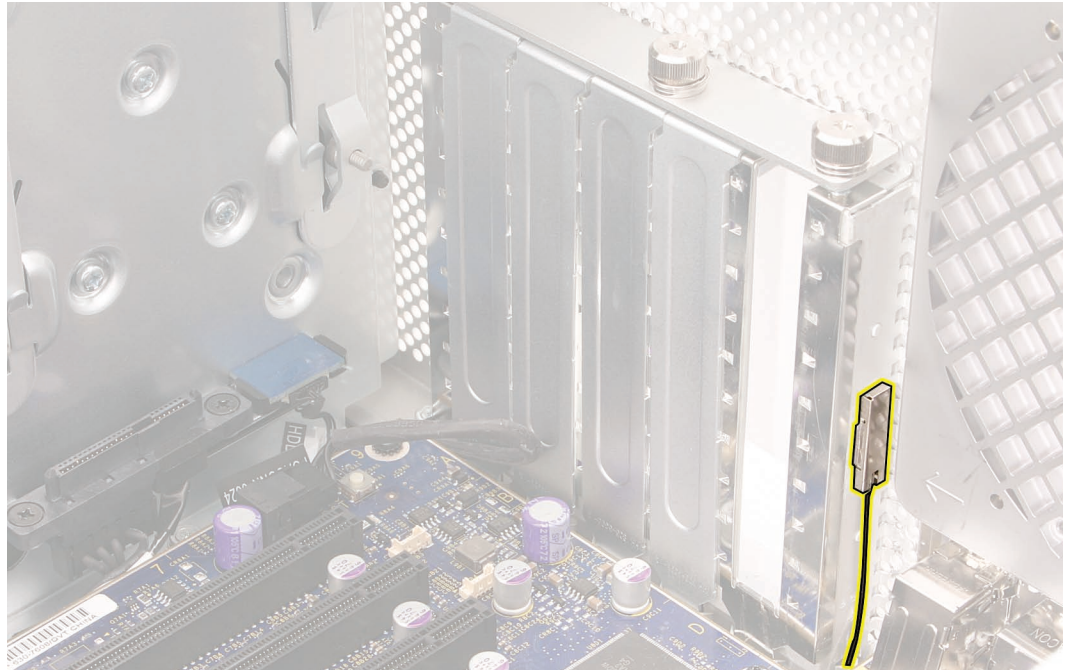

Procedure

1. Insert a jeweler's flat-blade screwdriver into the notch on either side of the Bluetooth antenna cage and carefully pry up the cage from the enclosure.

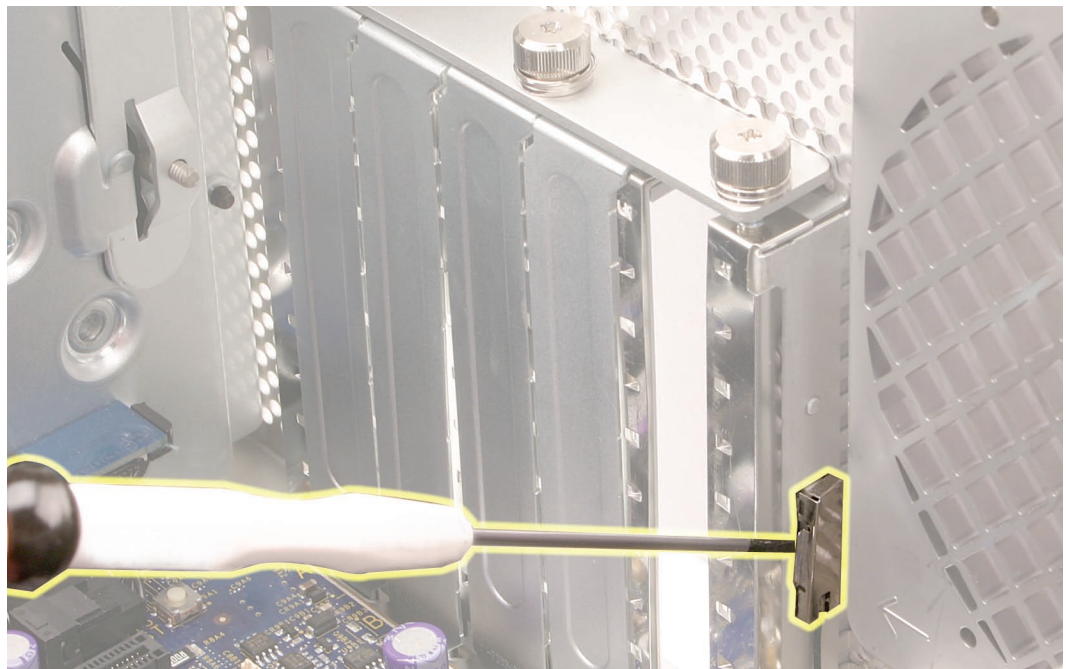

2. Remove the Bluetooth antenna from its routing under the PCI port cage.

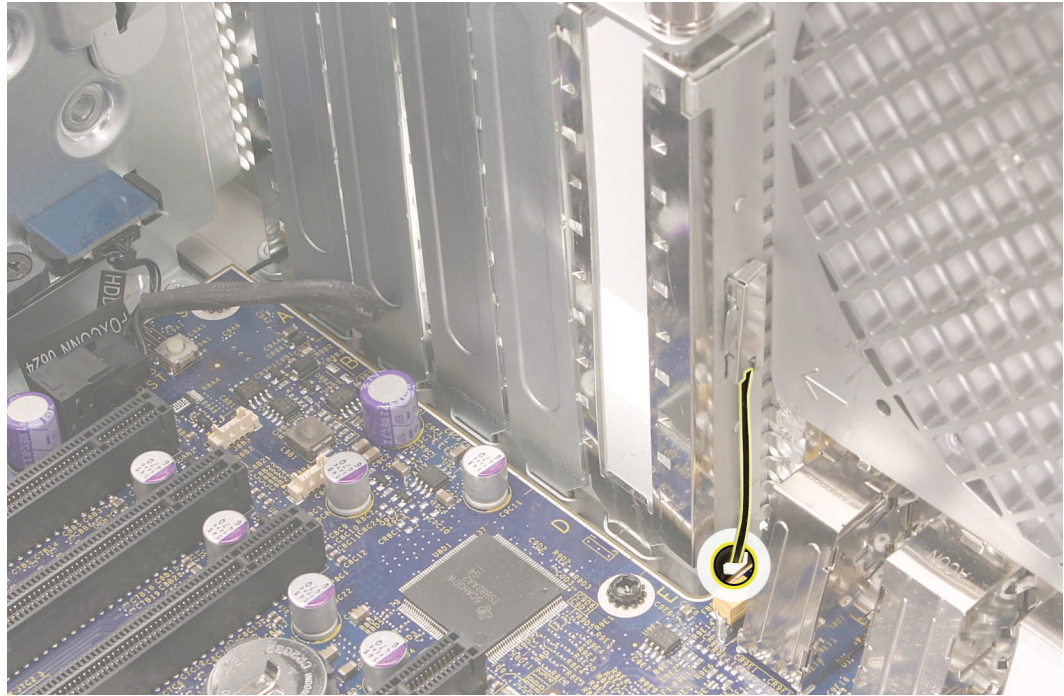

3. Remove the Bluetooth antenna from its guide on the far side of the PCI port cage.

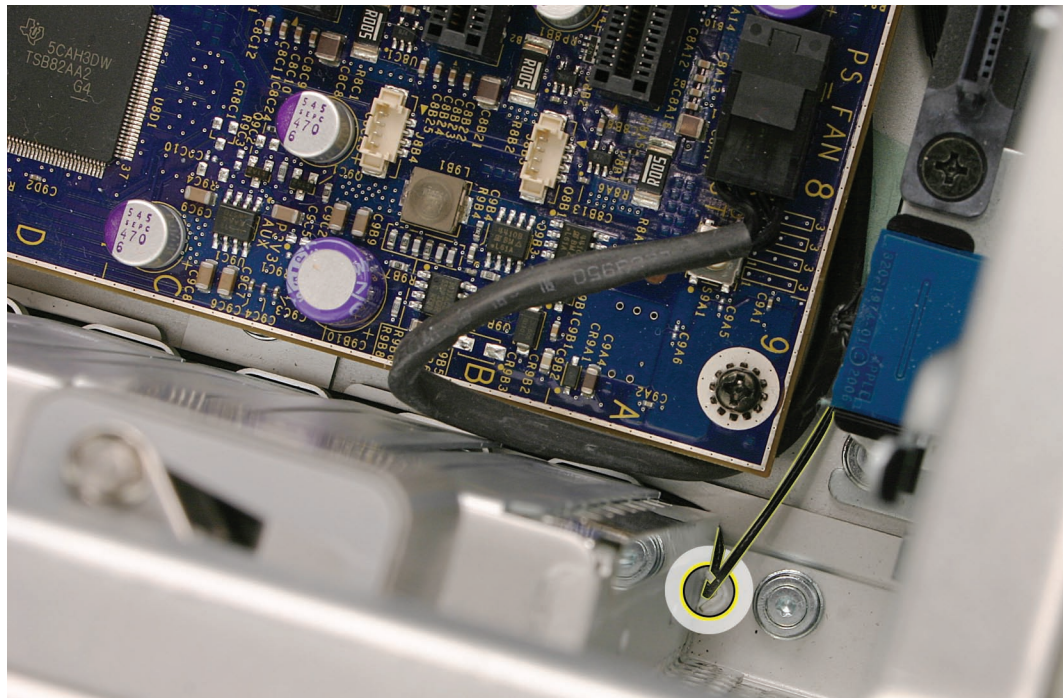

4. Remove the antenna board and antenna from the enclosure.



Hard Drive Cable Harness

The hard drive cable harness consists of the hard drive data cable and the hard drive power cable taped together. The cables are not available as separate service parts.

Tools

The only tools required for this procedure are a long-handled, magnetized #1 Phillips screwdriver.

Preliminary Steps

Before you begin, open the computer, lay it on its side with the access side facing up, and remove the following:

- [Hard drives and hard drive carriers in drive bays 1 and 2](#)
- [PCI Express card installed in slot 1](#)
- [Any 12-inch PCI Express cards](#)
- [Top and bottom memory cards](#)
- [Processor heatsink cover](#)
- [Front fan assembly](#)

Part Location



Procedure

1. Disconnect the hard drive data and power cable connectors from the logic board.

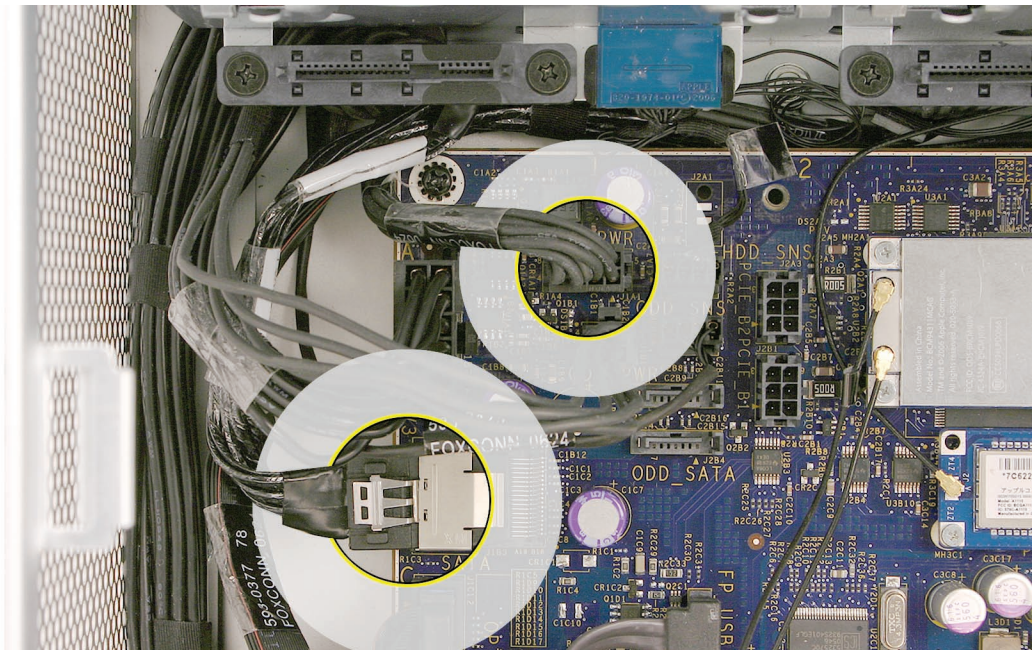

-
- Using a long-handled, magnetized #1 Phillips screwdriver, remove the two screws holding the hard drive cable harness connector to the bracket below hard drive bay 1.
 - Remove the connector from the bracket.
 - Repeat for the other three connectors below hard drive bays 2, 3, and 4.

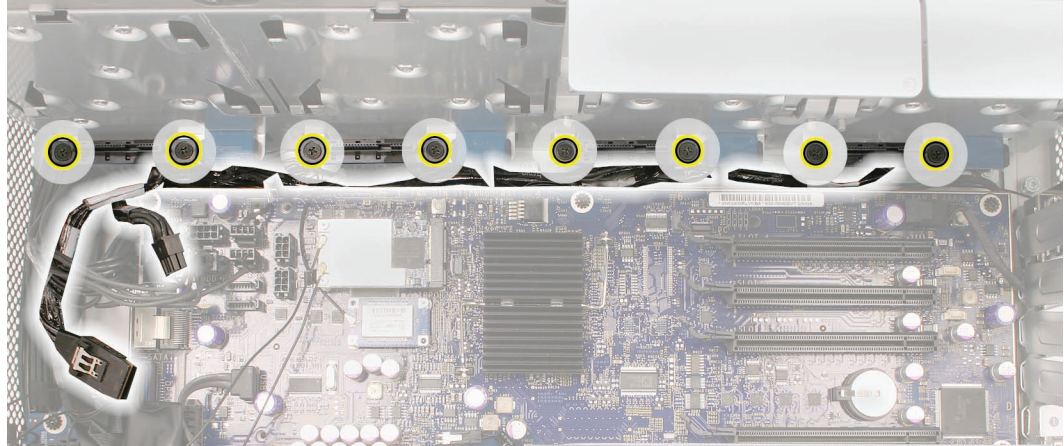

- Remove the hard drive cable harness from the enclosure.



Hard Drive Temperature Sensor Cable

The hard drive temperature sensor cable is a wire harness with four connectors, one for each hard drive temperature sensor. Be careful not to catch or damage any of the wires when removing the harness from the enclosure.

Tools

No tools are required for this procedure.

Preliminary Steps

Before you begin, open the computer, lay it on its side with the access side facing up, and remove the following:

- [Hard drives and hard drive carriers in drive bays 1 and 2](#)
- [PCI Express card installed in slot 1](#)
- [Any 12-inch PCI Express cards](#)
- [Top and bottom memory cards](#)
- [Processor heatsink cover](#)
- [Front fan assembly](#)

Part Location

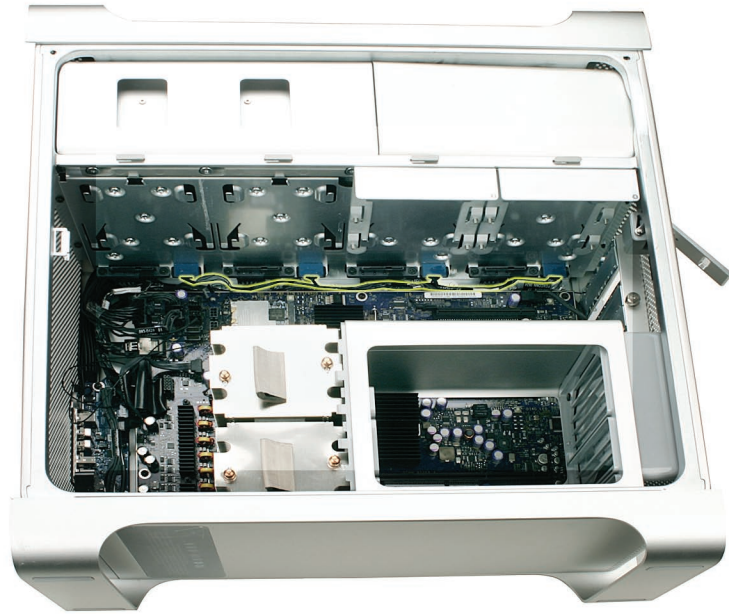

Procedure

1. Disconnect the hard drive temperature sensor cable from the logic board.
2. Disconnect the four connectors on the hard drive temperature sensor cable from the four hard drive temperature sensors.

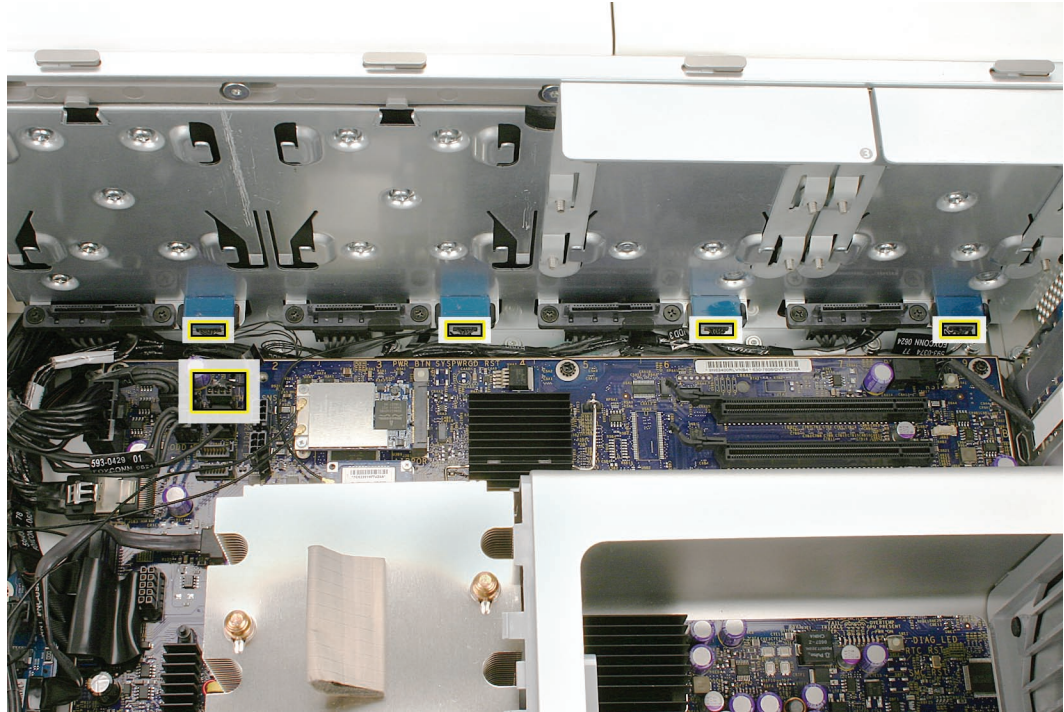

3. Remove the hard drive temperature sensor cable from the enclosure.

Replacement Note: The connectors on the hard drive temperature sensor cable are labeled with HDD1, HDD2, HDD3, and HDD4 to indicate the connector that belongs to each temperature sensor.



Hard Drive Temperature Sensor

There are four hard drive temperature sensors, one for each hard drive. This procedure explains how to remove the sensor for the hard drive in drive bay 1. The procedure for removing the other three sensors is similar, except that the only part you need to remove before beginning the procedure is the hard drive directly over the sensor.

Tools

The only tools required for this procedure are a mirror and a black stick or a flat-blade screwdriver.

Preliminary Steps

Before you begin, open the computer, lay it on its side with the access side facing up, and remove the following:

- [Hard drives and hard drive carriers in drive bays 1 and 2](#)
- [PCI Express card installed in slot 1](#)
- [Any 12-inch PCI Express cards](#)
- [Top and bottom memory cards](#)
- [Processor heatsink cover](#)
- [Front fan assembly](#)

Part Location

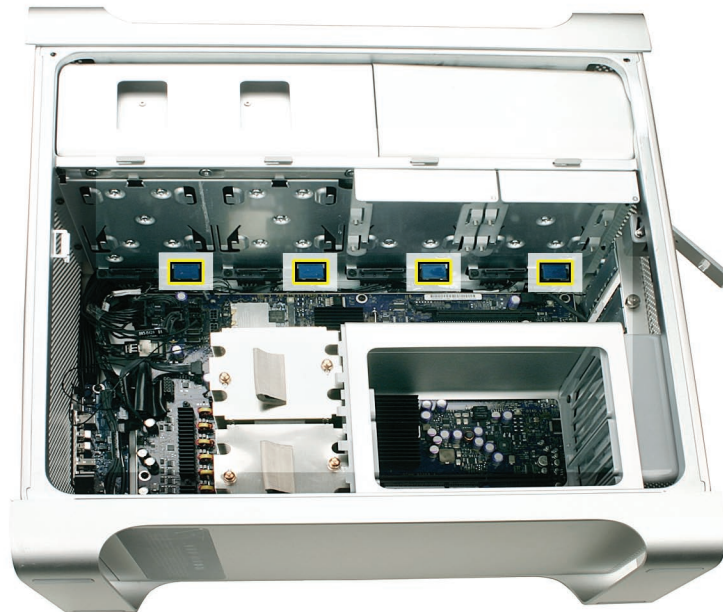

Procedure

1. Disconnect the sensor cable for the hard drive in bay 1 and move the cable out of the way.

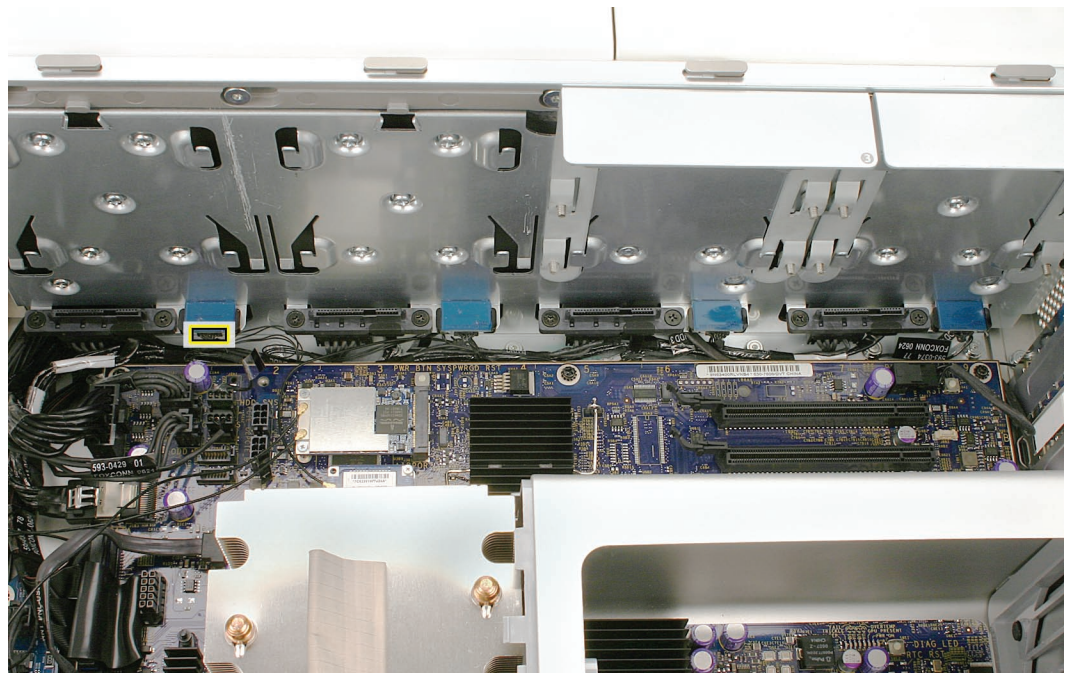

2. Using a mirror, locate the two round black nubs on the bottom of the hard drive sensor below hard drive bay 1.
3. Using a black stick or a flat-blade screwdriver, press up on the nubs and remove the sensor from the enclosure.

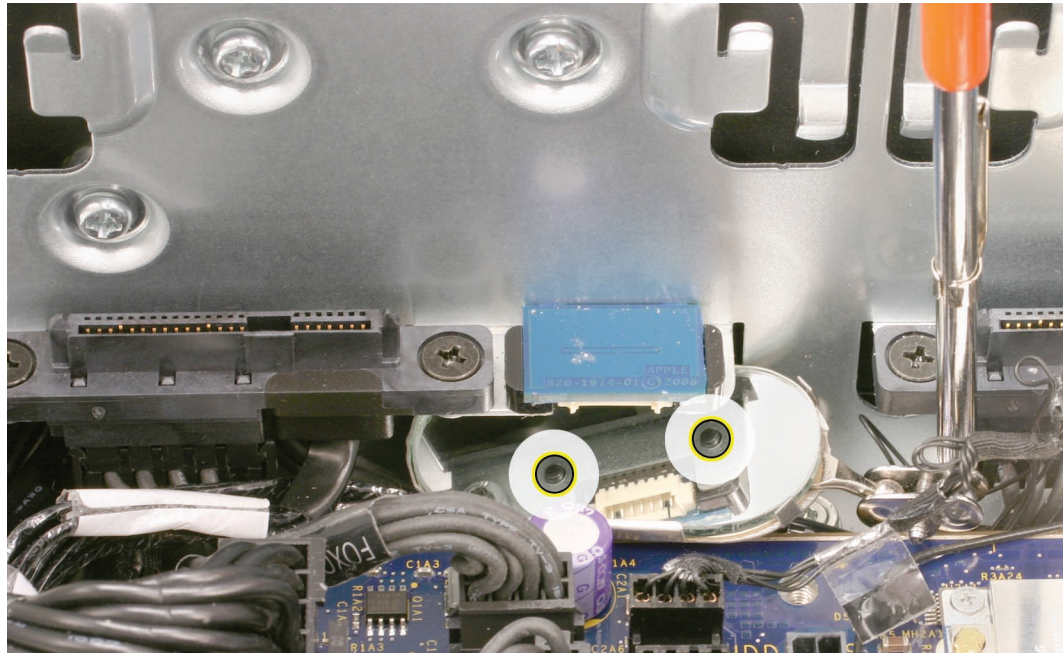



Power Cable Harness

The power cable harness consists of the following cables:

- Power supply PS1 cable
- Power supply PS2 cable
- Power supply PS3 cable
- Power supply PS4 control cable
- Front panel board power cable
- Front panel board audio cable
- Front panel board FireWire 800 cable

Tools

No tools are required for this procedure.

Preliminary Steps

Before you begin, open the computer, lay it on its side with the access side facing up, and remove the following:

- [All hard drives and hard drive carriers](#)
- [All PCI Express cards](#)
- [Top and bottom memory cards](#)
- [Processor heatsink cover](#)
- [Front fan assembly](#)
- [Processor heatsinks](#)
- [Memory cage](#)
- [Optical drive power cable](#)
- [Optical drive data cable](#)
- [Front panel board](#)
- [Optical drive carrier and optical drives](#)
- [Power supply](#)

Part Location

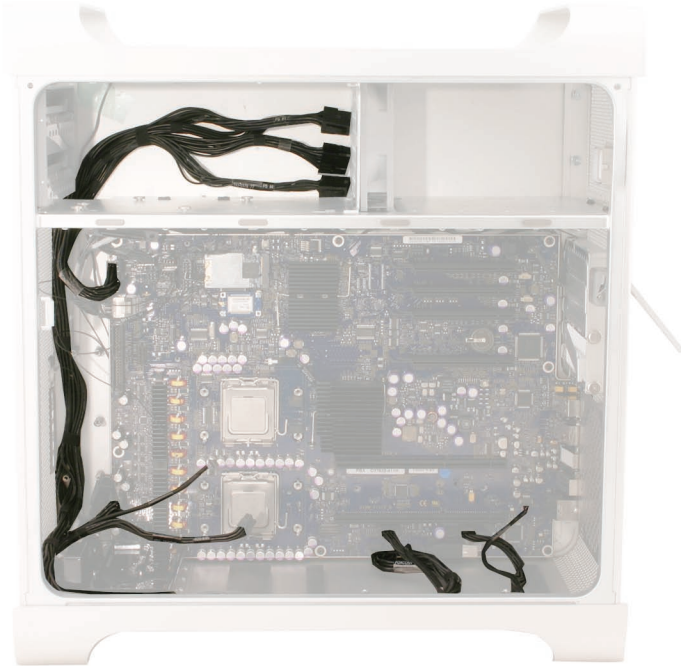

Procedure

1. Disconnect the power cable harness connectors from the logic board.

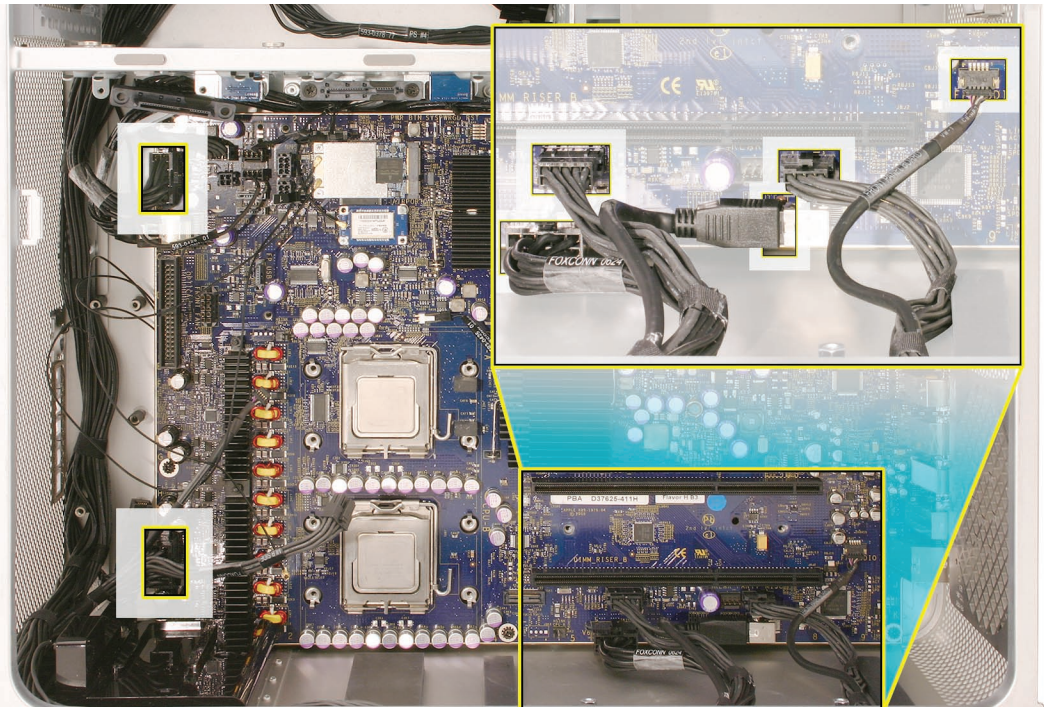

2. Slip the four connectors out through the opening in the media shelf, removing them one at a time.



3. Remove the power harness cable from its routing along the edge of the logic board, over the speaker assembly, and along the bottom lip of the enclosure.



4. Remove the power harness cable from the enclosure.

Apple Service Source



Troubleshooting
Mac Pro



General Information

Memory

The Mac Pro computer has two memory cards with a total of 8 memory slots. On each card, the slots are arranged as two banks of two slots each. The computer comes with a minimum of 1 GB of memory, installed as a pair of 512 MB fully buffered, dual inline memory modules (FB-DIMMs) in two of the DIMM slots. Additional DIMMs can be installed in the open DIMM slots, as illustrated below.

Note: DIMMs must be installed in pairs of equal size from the same vendor. In the following illustration, DIMMs in one colored pair do not need to match DIMMs in a different colored pair.

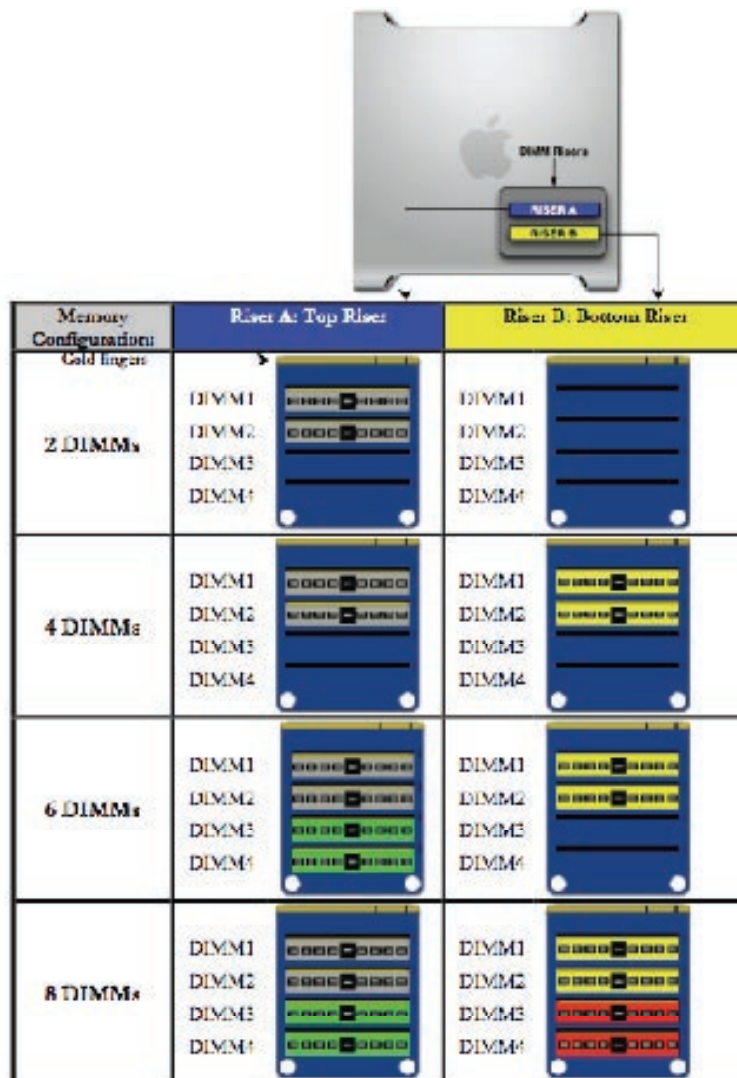

DIMMs for Mac Pro must fit these specifications:

- 667 MHz, FB-DIMMs
- 72-bit wide, 240-pin modules
- 36 devices maximum per DIMM
- Error-correcting code (ECC)

Important: For proper operation of Mac Pro computers, Apple recommends using only Apple-approved Mac Pro FB-DIMMs. Refer to GSX for Apple FB-DIMMs service part numbers.

PCI Express Cards

The Mac Pro logic board includes one double-wide PCI Express graphics slot and three PCI Express expansion slots, for a total of four slots. The computer comes with a graphics card installed in slot 1. You can install additional PCI Express graphics and expansion cards in the remaining three PCI Express expansion slots.

Important: Combined maximum power consumption for all four PCI Express slots must not exceed 300 W.

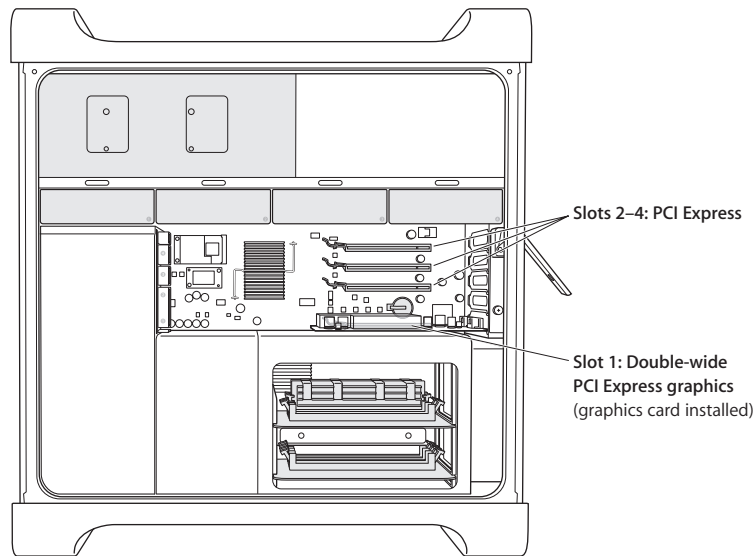

Note: Port 2 of the ATI Radeon X1900 XT graphics card is compatible with the Apple DVI-to-video adapter. See [KnowledgeBase article 304910](#).

Internal Cabling Matrix

The table on the next page lists all Mac Pro internal cables that connect to the logic board and are not part of a larger subassembly. Following the table is a map of the logic board connector locations, which are listed in column 5 of the table.

Cable, Connector and Signal Matrix											
CABLE DESCRIPTION	Service PN	LENGT H (mm)	LENGT H (in)	MLB CONN LOCATION	MLB CONN LABEL	MLB CONN DESCRIPTION	CONNECTOR 2 DESCRIPTION	CONNECTOR 3 DESCRIPTION	CONNECTOR 4 DESCRIPTION	CONNECTOR 5 DESCRIPTION	POWER / SIGNALS CARRIED
HDD Power	Part of 922-7682	442	17.4	A-1	HDD_PWR	8-pin (2X4)	15-pin flat to HDD 1	15-pin flat to HDD 2	15-pin flat to HDD 3	15-pin flat to HDD 4	DC power to all four HDDs from main logic board
HDD Thermal Sensor	922-7730	610	24.0	A-2	HDD_SNS	4-pin flat (4X1)	7-pin flat to sensor bd underneath HDD 1	7-pin flat to sensor bd underneath HDD 2	7-pin flat to sensor bd underneath HDD 3	7-pin flat to sensor bd underneath HDD 4	Thermal sensor signals from sensors in all HDD bays to main logic board
Optical Drive Power	922-7684	559	22.0	B-1	ODD_PWR	4-pin square (2X2)	standard 4-pin (4x1) to upper ODD	standard 4-pin (4x1) to lower ODD			DC power to both optical drives from main logic board
Optical Drive IDE	922-7686	586	23.1	D-1	OPTICAL	40-pin standard IDE (20X2)	Standard 40-pin IDE for lower ODD	Standard 40-pin IDE for upper ODD			IDE signals to/from all optical drives and main logic board
Power Supply PS#1	922-7687	1170	46.1	K-6	none	Large 10-pin (5X2)	Large 10-pin (5X2) from PS labeled PS#1				DC power to main logic board from power supply
Power Supply PS#2	922-7688	605	23.8	J-1	none	Large 10-pin (5X2)	Large 10-pin (5X2) from PS labeled PS#2				DC power to main logic board from power supply
Power Supply PS#3	922-7689	370	14.6	B-1	none	Large 12-pin (6X2)	Large 12-pin (6X2) from PS labeled PS#3				DC power to main logic board from power supply
Power Supply Control PS#4	922-7685	1160	45.7	K-6	none	Medium 10-pin (5X2)	Large 10-pin (5X2) from PS labeled PS#4				Power supply control signals to/from main logic board
Front Panel Board Power	922-7690	860	33.9	K-7	FP_MISC	Medium 8-pin (4X2)	Medium 8-pin (4X2) on top of FP bd				Power, power LED, power button, and control signals to the front panel board from the main logic board
Front Panel Board Audio	922-7692	865	34.1	J-9	FP_AUDIO	Small sideways 5-pin (5X1)	Small sideways 5-pin on top of FP bd				Audio signals to the front panel board from the main logic board
Front Panel Board FireWire-800	922-7691	695	27.4	K-7	FP_FWB	9-pin sideways standard FW800 bd	9-pin sideways standard FW800 bd on bottom of FP bd				Standard FW800 9-pin to 9-pin cable to front panel board from main logic board
Front Panel Board USB	922-7693	150	5.9	C-2	FP_USB	Small 7-pin rt angle (7X1)	Small 7-pin rt angle in middle of FP bd				USB 2.0 power and data to front panel board from main logic board
Intake Ambient Temperature Sensor	922-7731	400	15.7	B-2	ODD_SNS	Small 4-pin (4X1)	Small 7-pin on thermal sensor bd inside top of ODD bay				Thermal sensor signals from ODD bay ambient temp sensor to main logic board

Cable Connector Locations

Use the diagram below to find the location of the internal cable connectors on the logic board.

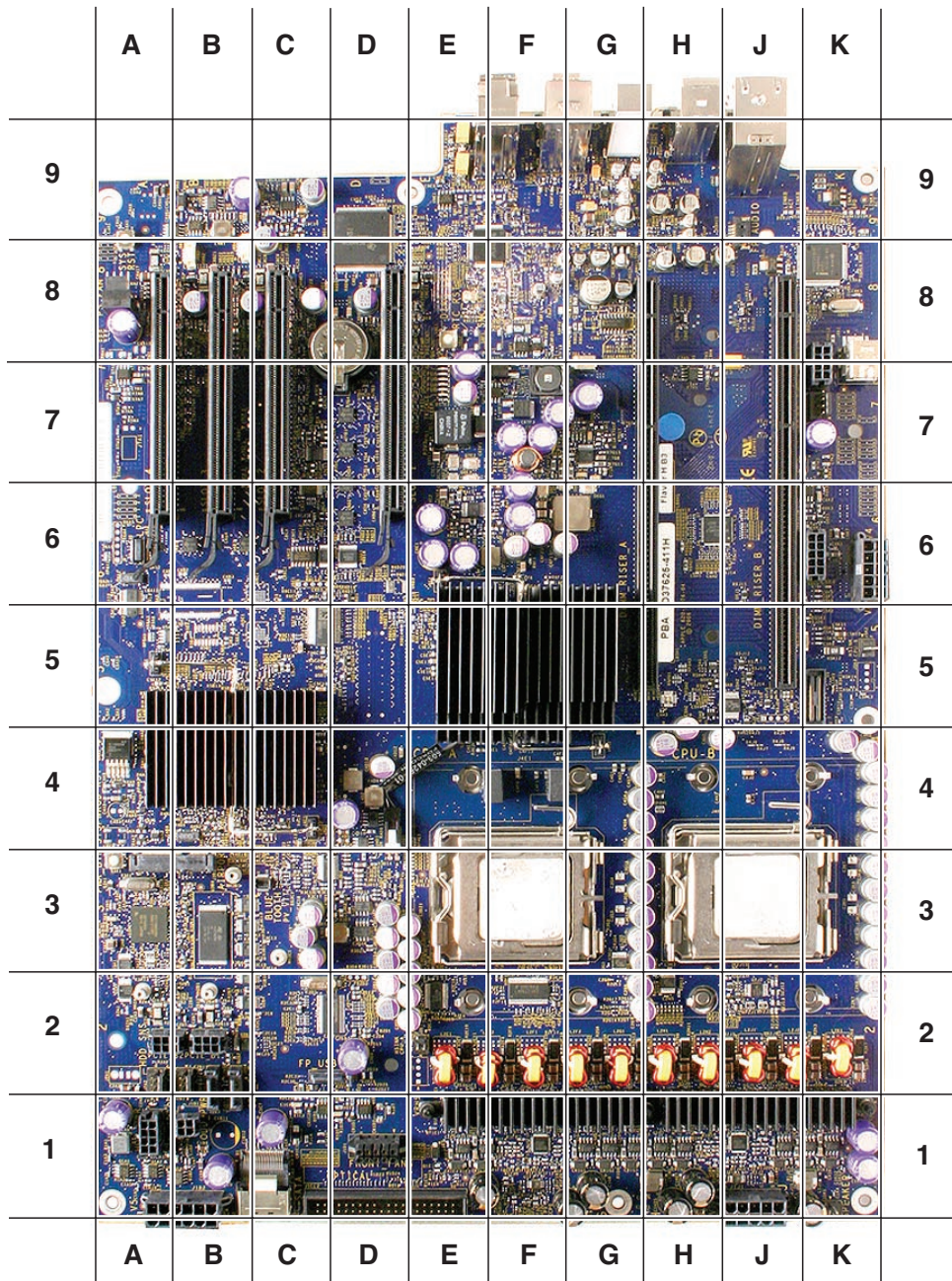

Thermal Calibration

Unlike in earlier Power Mac G5 computers, replacing a processor in a Mac Pro computer does not require running Apple Service Diagnostic for thermal calibration.

Block Diagram

The architecture of the Mac Pro is based on two dual-core Intel Xeon processors, the North Bridge memory controller and the South Bridge I/O controller, as shown in the simplified block diagram below.

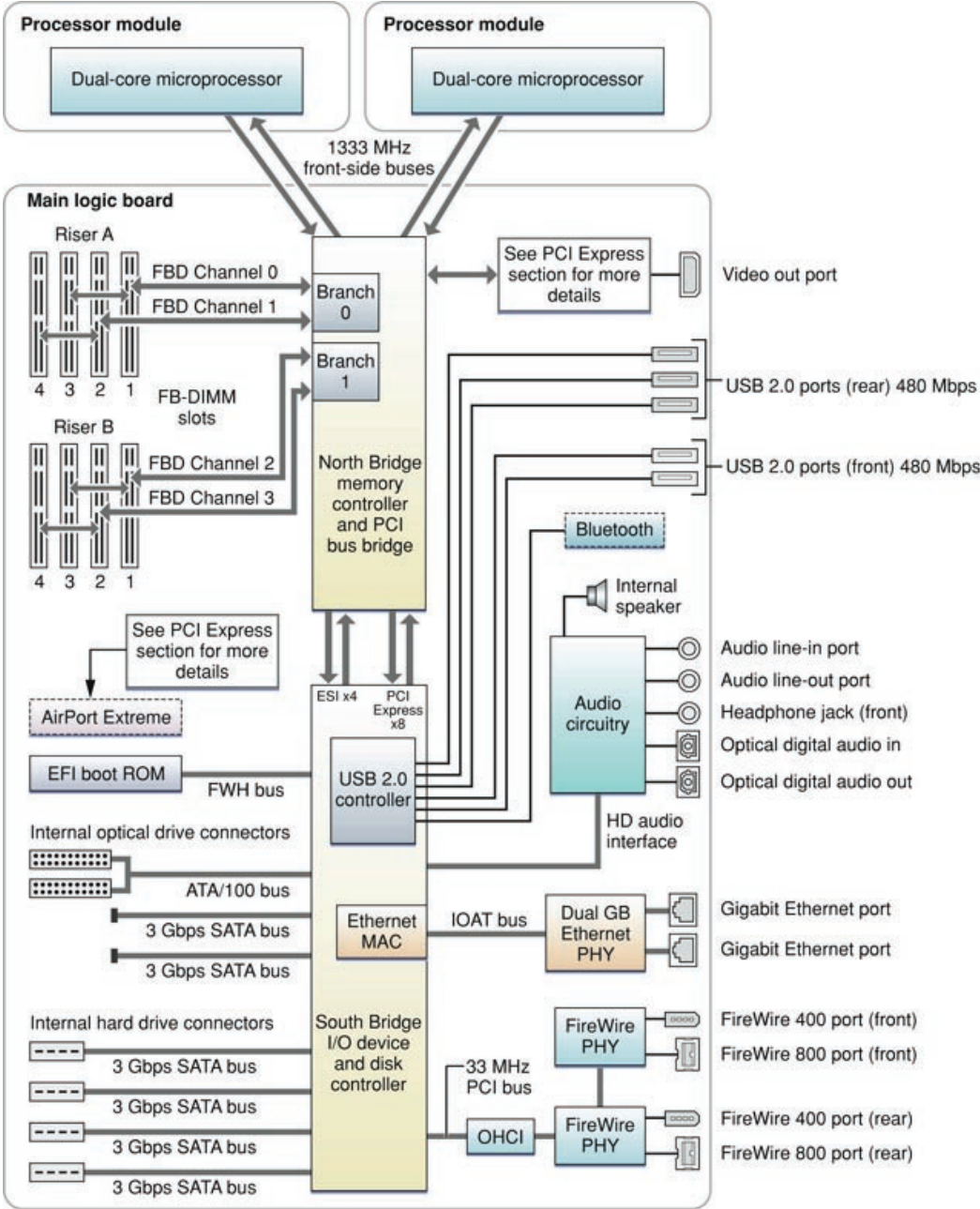

Resetting the Logic Board

System Management Controller (SMC) Reset

The System Management Controller (SMC) is a chip on the logic board that controls all power functions for the computer. If the computer is experiencing any power issue, resetting the SMC may resolve it. The SMC controls several functions, including:

- Telling the computer when to turn on, turn off, sleep, wake, idle, and so forth
- Handling system resets from various commands
- Controlling the fans

It is also recommended that the SMC be reset after a logic board, ambient board, or ambient board cable is replaced as part of a repair.

Note that resetting the SMC does not reset the PRAM. Resetting the SMC will not resolve issues in which the computer is unresponsive—in these situations, restarting the computer will generally suffice. If the computer isn't responding, perform these steps one at a time, in the following order, until the issue has been resolved:

1. Force Quit (Option-Command-Escape)
2. Restart (Control-Command-Power)
3. Force Shut Down (press the power button for 10 seconds)

Resetting the SMC can resolve some computer issues such as not starting up, not displaying video, sleep issues, fan noise issues, and so forth. If the computer still exhibits these types of issues after you've restarted the computer, try resetting the SMC. There are two ways to reset the SMC on Mac Pro.

You can use the SMC reset switch:

1. From the Apple menu, choose Shut Down (or if the computer is not responding, hold the power button until it turns off).
2. Press the SMC_RST switch, which is located to the right and slightly below the row of diagnostic LEDs. (See the [LED diagram](#) in the following "Diagnostic LEDs" section.) To press the switch, use the nylon probe tool (Apple part number 922-5065).
3. Press the power button to start up the computer.

Or, you can reset the SMC by removing AC power:

1. From the Apple menu, choose Shut Down (or if the computer is not responding, hold the power button until it turns off).
2. Unplug the AC power cord.
3. Wait at least 15 seconds.
4. Plug the power cord back in, making sure the power button is not being pressed at the time.
5. Press the power button to start up the computer.

Real Time Clock (RTC) Reset

The Real Time Clock (RTC) is a chip on the logic board that controls the date and time functions of the computer. If the computer is experiencing an issue booting, resetting the RTC may resolve it. Follow these steps to reset the RTC:

1. From the Apple menu, choose Shut Down (or if the computer is not responding, hold the power button until it turns off).
2. Unplug the AC power cord.
3. Remove the battery for at least 20 seconds. You may need to remove a PCI Express card to have access to the battery.

System Reset

Mac Pro has a system reset switch on the logic board that may be used to restart the system while it is powered up. This switch can be used to determine if a computer that won't consistently boot from a cold start has power supply issues. Follow these steps to reset the system:

1. With the computer powered up, press the SYS_RST switch located in the upper right-hand corner of the logic board. To press the switch, use the nylon probe tool (Apple part number 922-5065).
2. If the computer boots after you press the SYS_RST switch, try shutting the computer off and restarting by pressing the front power button. If the computer restarts when you press the SYS_RST switch but not from a cold start, the power supply may need to be replaced.

Power-On Self Test: RAM and Processor Verification

A power-on self test in the computer's ROM automatically runs whenever the computer is started up after being fully shut down (the test does not run if the computer is only restarted). If the test detects a problem, the status LED located above the power button on the front of the computer will flash in the following ways*:

- 1 Flash: No RAM is installed or detected. Or, the quick memory test failed. An LED will light up on the DIMM riser card next to the affected DIMM or empty DIMM slot.
- 3 Flashes: A RAM bank failed extended memory testing. An LED will light up on the memory riser card next to the affected DIMM.

Troubleshooting: Try reseating the memory DIMMs. Check memory installation instructions for proper installation order. Swap affected DIMM with known good DIMM.

***Note:** The status LED lights up when the power button is depressed at startup. Do not count this light as one of the diagnostic flashes. The memory riser card diagnostic LEDs will also flash briefly when the computer is started up or shut down and when it goes in and out of sleep mode. This is normal behavior.

Diagnostic LEDs

The Mac Pro logic board includes a set of LEDs to help service providers troubleshoot the computer. The LEDs are located toward the rear of the logic board, under the memory cage, next to PCI card slot 1. You can view these LEDs by removing the computer's side access panel and looking through the memory cage to the logic board below. LEDs 2, 3, 4, and 5 are normally off and will automatically illuminate if an error occurs. To read LEDs 1, 6, 7, and 8, you must press the DIAG_LED button, which is adjacent to the LEDs. To press the DIAG_LED button, use the nylon probe tool (Apple part number 922-5065).

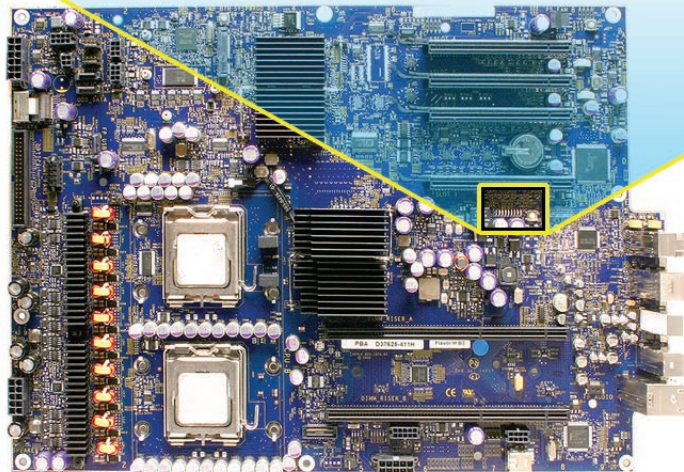
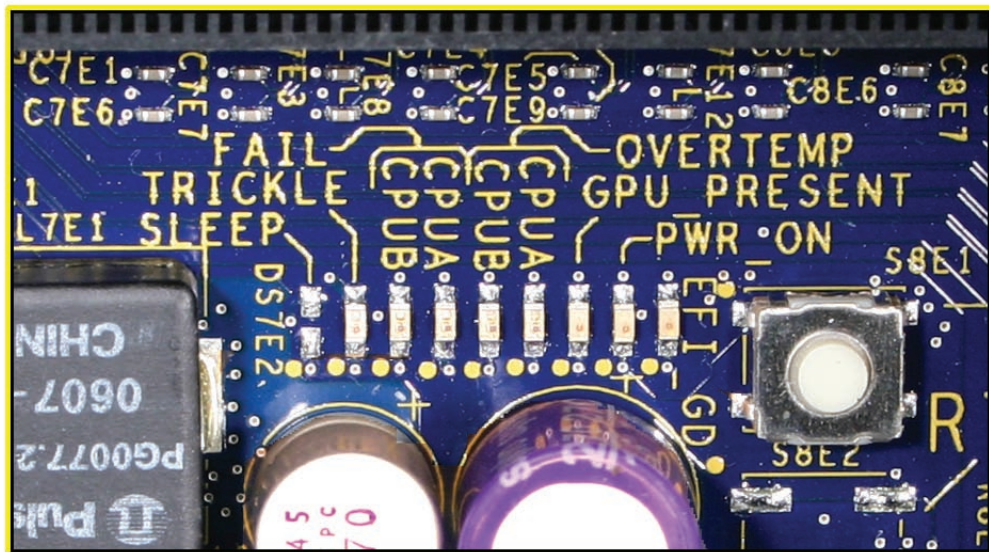

Use the following table to interpret the LEDs.

Location	Name	Color	Nominal	Press DIAG_LED button to display	Indicates
Led 1	Trickle Pwr	Yellow	On	Yes	Power supply is providing trickle power
Led 2	CPU B Error	Red	Off	No	CPU B halts on an IERR (instruction error)
Led 3	CPU A Error	Red	Off	No	CPU A halts on an IERR (instruction error)
Led 4	CPU B OT	Red	Off	No	CPU B is over temperature
Led 5	CPU A OT	Red	Off	No	CPU A is over temperature
Led 6	GPU Present	Green	On	Yes	EFI has configured the graphics card
Led 7	Power On	Green	On	Yes	All power rails are functioning
Led 8	EFI Done	Green	On	Yes	EFI is done loading

Note: There is a position on the logic board next to LED 1 for a SLEEP LED that does not have any LED installed. This is normal; the LED was used only in development. To determine if a Mac Pro computer is in sleep mode, watch the power LED on the front of the computer. It will slowly change brightness levels if the computer is sleeping.

LED 1 Trickle Power

Normally on when DIAG_LED button is pressed.

If LED 1 is not on, the symptom would be that the computer won't power on.

Troubleshooting:

- Check AC cord is connected to a working AC wall outlet.
- Reseat AC Plug.
- Check connections of power supply cables to the logic board.
- Check power supply cable connections at power supply.
- Replace power supply.

LED 2 CPU B (Lower Processor) Error

LED 3 CPU A (Upper Processor) Error

Normally off. These LEDs come on if an error occurs or if the BootROM is corrupted. They do not depend on the DIAG_LED button being pressed.

Related symptoms include no video or the computer is hung up. If the BootROM is corrupted, the optical drive tray should eject, prompting for the insertion of a recovery disc to restore the BootROM.

Troubleshooting:

- With the computer booted, up press the SYS_RST switch. If this clears the CPU Error LED, check for incompatible device driver software that may have been installed for added hardware.
- If the Error LED is still on, power down the computer and try pressing the SMC_RST switch. Restart the computer.
- Reset the power supply by unplugging the AC cord for 10 seconds.
- Unplug AC cord and remove any added DIMMs and PCI Express cards. If this causes the LED to go off, repopulate the DIMMs and/or PCI Express cards to find the combination that caused the LED to come on. Overheated memory could be a possible cause for this CPU error LED to come on. Check fan operation.
- Unplug the AC cord and remove the battery for 10 seconds. You may need to remove a PCI Express card to get to the battery. Reinstall the battery and restart the computer.
- Try swapping CPU A and CPU B locations. If the CPU Error LED follows the CPU, replace that CPU.
- Try replacing the logic board.

LED 4 CPU B (Lower Processor) Overtemp

LED 5 CPU A (Upper Processor) Overtemp

Normally off. These LEDs come on if an error occurs. They do not depend on the DIAG_LED button being pressed.

These two LEDs can operate in two different modes; they will either flash or stay on. If either LED is flashing, it may indicate an initial processor over-temperature condition. If either LED is solidly on, it may indicate a chronic processor over-temperature condition. Initial processor over-temperature can cause symptoms such as sluggish computer performance. Chronic processor over-temperature can cause the computer to hang completely. If both LEDs are solidly on at power up, the power supply cables may be improperly seated.

Troubleshooting:

- Verify proper heat sink installation.
- Verify all thermal sensors are properly connected.
- Verify all fans are operating properly, especially the front intake fan.
- Verify power supply cables are properly seated
- If both overtemp LEDs come on immediately when the computer is turned on, a faulty power supply could be one cause of this behavior. Replace power supply.

-
- Replace the processor associated with the corresponding LED.

LED 6 GPU Present

Normally on when DIAG_LED button is pressed.

If this LED is on, it indicates there is a graphics card installed and recognized by the computer. It does not indicate that the graphics card is fully functional. Some graphics cards require additional power to function, which is available from connectors on the logic board. For these cards, if the auxiliary booster power cable is not connected between the logic board and the graphics card, an error message reminding about this additional power connection will be displayed as Mac OS X starts up.

Troubleshooting:

- Check that the graphics card is seated correctly in its PCI slot.
- Check that the card's auxiliary booster power cable is connected properly (if the card requires one).
- Verify power supply cables are properly seated.
- Try the graphics card in a different PCI slot.
- Try a different graphics card.
- If an error message about graphic card booster power connection is displayed, check that the appropriate booster power cable is firmly connected between the logic board and the graphics card.
- Replace the logic board.

LED 7 Power On

Normally on when DIAG_LED button is pressed.

If this LED is on, it indicates the power supply is functioning.

Troubleshooting:

- Check that the power cables to the logic board are properly attached.
- Check the cable connections at the power supply.
- Check for any signs of an obvious electrical short, e.g. metal screws or PCI card slot cover loose inside computer touching the logic board.

LED 8 EFI Good

Normally on when DIAG_LED button is pressed. Takes approximately 5 seconds after power up.

If this LED is on, it indicates that the computer has completed the on board Extensible Firmware Interface (EFI) operations and the operating system is now in control.

Troubleshooting:

- Check that LED 7 Power On LED is on.
- Check that LEDs 2, 3, 4, and 5 are off.
- Try removing any added hardware.
- Try removing any added DIMMs.

Memory Riser Card Diagnostic LEDs

Both of the memory riser cards include diagnostic LEDs for each DIMM. Each of the LEDs will light if it detects an issue with the corresponding installed DIMM. These LEDs will also flash briefly when the computer is started up or shut down and when it goes in and out of sleep mode. This is normal behavior.

Troubleshooting:

- Shutdown and restart the computer.
- Try reseating the DIMMs.
- Check memory installation instructions for proper installation order.
- Swap affected DIMM with known good DIMM.
- Try moving DIMM to another slot (within the same bank of two) to see if the failure LED follows the DIMM. If so, replace DIMM with known good DIMM.

Video Card Diagnostic LEDs

The Radeon X1900 XT video card also has diagnostic LEDs. These LEDs will also flash briefly when the computer is started up or shut down and when it goes in and out of sleep mode. This is normal behavior

T_Fault LED

Normally off, this LED lights up if the graphics chip gets too hot.

Troubleshooting:

- Check that the front fan is working.
- Try re-seating the card in the PCI Slot.
- Make sure the card's auxiliary booster power cable is connected (if there is one).
- Re-boot the computer.
- Try a different video card.
- Replace the video card.

Ext_Power LED

Normally off, this LED lights up if the auxiliary power isn't being supplied.

Troubleshooting:

- Make sure the card's auxiliary booster power cable is connected (if there is one).
- Check connections from the power supply to the logic board.
- Try a different auxiliary power cable.
- Try a different video card.
- Replace the video card.

Power Supply Verification

To power on, the computer's logic board requires "trickle" power. If the system fails to power on, first reset the SMC as described in this chapter. If the computer still doesn't power on, follow the procedure outlined below to determine whether the issue is related to the power supply.

Verify trickle power

Diagnostic LED 1 indicates the presence of trickle power required by the logic board to begin the startup process.

LED 1 should be yellow when the DIAG_ LED button is pressed, indicating that trickle voltage is present.

Verify Power Supply Is Providing Power

Diagnostic LED 7 indicates that the main power is OK and within regulation.

Plug in AC power cord, and press the power-on button on the front panel.

LED 7 should be green when the DIAG_ LED button is pressed, indicating that the main power is OK and within regulation.

If diagnostic LED 4 and LED 5 are both solidly illuminated at power up, improperly seated power supply cables could be one cause of this behavior. Check all power supply cable connections to ensure they are properly seated.

Mac Pro Firmware Updates

Firmware is the name given to software that is written into memory circuits, such as flash memory, that will hold the software code indefinitely, even when power is removed from the hardware. Firmware on Intel Mac computers is designed to be updated if necessary through a software update.

EFI and SMC firmware is stored on the Mac Pro's logic board. EFI firmware updates update the Boot ROM, and SMC updates update the System Management Controller firmware. The SMC manages fans and other environmental parameters that are independent of the Boot ROM.

Firmware symptoms can be easily mistaken for hardware issues (e.g., overheating issues, fan noise issues, etc.). Always check both EFI and SMC firmware versions and update if necessary before replacing any hardware components in the Mac Pro.

The following lists describe the type of symptoms that may be resolved by updating the EFI and SMC firmware in the Mac Pro.

Symptoms that may be resolved by updating EFI firmware:

- Cannot eject media (various conditions)
- No video on start up

-
- Blue system failure screens in Windows XP/Vista
 - Not waking or sleeping when expected
 - Bad media taking too long to eject (including holding mouse button down at startup taking minutes to eject)

Symptoms that may be resolved by updating SMC firmware:

- Fan related behavior (excessive speed or noise)
- Loud audible clicking from some fans
- Thermal shut down or warnings
- Diagnostics reporting failures
- Sleep/wake issues
- Intermittent shut down
- SMC causes bad/missing ambient sensor to cause the computer to go to sleep
- Hangs, black screen on restart from Windows
- Quick power cycle causes Memory Riser Card Diagnostic LEDs & CPU Overtemp LEDs to illuminate solidly
- Unit does not restart after changing configuration in Expansion Slot Utility

Please follow the steps outlined in KnowledgeBase article 303364, "About Firmware Updates for Intel-based Macs," to perform an EFI and/or SMC firmware update. Information about firmware versions for Intel Macs can be found in KnowledgeBase article 303880, "Mac OS X: Firmware Updates for Intel-based Macs."



Symptom Charts

How to Use the Symptom Charts

The Symptom Charts included in this chapter will help you diagnose specific symptoms related to the product. Because cures are listed on the charts in the order of most likely solution, try the cures in the order presented. Verify whether or not the product continues to exhibit the symptom. If the symptom persists, try the next cure.

Note: If a cure instructs you to replace a module, reinstall the original module before you proceed to the next cure.

Important: The only way to shut off power completely to the computer and display is to disconnect their power plugs from the power source. Make sure the power cords to the computer and display are within easy reach.

Startup Failures

When testing a computer for the following symptoms, remove the side access panel so you can better observe or listen for fan movement.

Note: Be sure to check the [“Memory”](#) and [“Power-On Self Test”](#) topics in the General Information section of this chapter. Incorrect installation of DIMMs or incompatible memory will not allow the system to start up correctly. For information on how to correctly install DIMMs, see the [“Memory \(DIMMs\)”](#) topic in the Take Apart chapter.

Important: For troubleshooting purposes, Mac Pro computers may be started up and diagnosed with a single processor installed in either the upper (CPU A) or lower (CPU B) position.

Power-on LED does not illuminate when power button is pressed, fans do not spin, and there is no boot tone or video

1. Verify power outlet is good.
2. Check that diagnostic LED 1 is on when the power cord is connected.
3. Replace power cord.
4. Check that diagnostic LED 1 is on when the power cord is connected.
5. Reset the logic board. Refer to “Resetting the Logic Board” in this chapter.
6. Verify power supply cables are properly seated.
7. Verify that processors are properly seated. Check diagnostic LED 2 and/or LED 3.

-
8. Verify that processors' mounting clamps are properly tightened.
 9. Test whether the front panel board or power button is at fault. Remove the installed front panel board and test with a known-good front panel board.
 10. Replace front panel board.
 11. Replace power button.
 12. Replace power supply.
 13. Replace logic board.

Power-on LED illuminates when pressed in, but goes out when button is released, there is no boot tone or video, but you can hear a small click

1. Check diagnostic LED 1 for trickle voltage from the power supply. Refer to "[Power Supply Verification](#)" in this chapter. If verification fails, replace power supply.
2. Verify that the processors are properly seated. Check diagnostic LED 2 and/or LED 3.
3. Verify that the processor mounting clamps are properly tightened.
4. Verify power supply cables are properly seated.
5. Replace the power supply.

Power-on LED illuminates when power button is pressed but fans do not spin (or spin only momentarily) and there is no boot tone or video

1. Reseat video card. (Make sure video card is fully inserted in connector and end of card is secured by the connector latch.) For video cards that require power cables, check that they are connected.
2. Reset logic board. Refer to "[Resetting the Logic Board](#)" in this chapter.
3. Verify power supply cables are properly seated.
4. Check diagnostic LED 2 and/or LED 3 for processor connection.
5. Reseat processors and check for bent pins.
6. Check diagnostic LED 1 for trickle voltage from the power supply. Refer to "[Power Supply Verification](#)" in this chapter. If verification fails, replace power supply.
7. Replace logic board.
8. Replace processor.

Power-on LED illuminates when power button is pressed and fans spin continuously but there is no boot tone or video

1. Reseat video card. (Make sure video card is fully inserted in connector and end of card is secured by the connector latch.) For video cards that require power cables, check that they are connected.
2. Verify speaker cable is fully seated.

-
3. Reset logic board. Refer to "[Resetting the Logic Board](#)" in this chapter.
 4. Verify power supply cables are properly seated.
 5. Check diagnostic LED 2 and/or LED 3 for processor connection
 6. If only one of the CPU Error LEDs (LED 2 or 3) comes on, try swapping the processors. If the Error LED follows the processor to the other processor location, replace that processor.
 7. Replace logic board

Power-on LED illuminates when power button is pressed, fans spin, and boot tone chimes, but there is no video

1. Verify display is properly connected and powered on.
2. Check video card connector and display cable for any bent pins.
3. Reseat video card. (Make sure video card is fully inserted in connector and end of card is secured by the connector latch.) For video cards that require power cables, check that they are connected.
4. Reset PRAM (restart computer while holding down Command-Option-P-R keys until second boot tone chimes)
5. Reset logic board. Refer to "[Resetting the Logic Board](#)" in this chapter.
6. Verify power supply cables are properly seated.
7. Replace video card
8. Replace logic board

Power-on LED does not illuminate when power button is pressed, but fans spin, boot tone chimes, and there is video

1. Verify power supply cables are properly seated.
2. Reseat front panel board
3. Replace front panel board
4. Replace logic board
5. Replace power supply

Power-on LED illuminates, fans spin up, no boot tone, and the system shuts down within a few minutes

1. Open the side access panel and observe all diagnostic LEDs. Refer to "[Diagnostic LEDs](#)" in this chapter for more information on how to locate and interpret these LEDs. Troubleshoot further if any LEDs indicate any failure.
2. Verify power supply cables are properly seated.
3. Reseat the processors and check for bent pins

-
4. Replace the processors
 5. Replace the logic board
 6. Replace the power supply

Fans

Individual fan failure

1. Verify fan is properly connected.
2. Verify all other fans are working properly. If all fans seem to have failed, the problem is most likely not the fans. Reset the logic board to see if this resolves this problem.
3. Replace fan
4. Replace logic board

Fans run at high speed (computer may shut down or may just hang and not shut down as a result)

1. Check for proper ventilation around the exterior of the computer.
2. Remove the computer's side access panel and observe the diagnostic LEDs, specifically LED 4 and LED 5 (the CPU A and B Overtemp LEDs). Refer to "[Diagnostic LEDs](#)" in this chapter for more information on how to locate and interpret these LEDs. If either LED is flashing, it may indicate an initial processor over-temperature condition. If either LED is solidly on, it may indicate a chronic processor over temperature condition.
3. Verify proper processor heat sink installation (see the take apart section for more information on heat sink installation).
4. Verify all thermal sensors and their cables are properly connected, especially the ambient temperature sensor board.
5. Verify all fans are operating properly and are unobstructed, especially the front intake fan.
6. Verify that the proper type of memory is installed. (See "[Memory](#)" in the Take Apart chapter for more information.)
7. Replace power supply.

Computer performance seems sluggish or slow, or computer is completely hung

1. Start up the computer from a known-good volume, such as its Installation disc, or an external hard drive, to isolate the issue to software or hardware. If the computer seems to perform adequately when booted in this way, troubleshoot as a software issue. If the computer continues to perform sluggishly when booted this way, continue following the steps below.
2. Run Apple Service Diagnostic to verify hardware is functional. Address any diagnostic failures as necessary.
3. Check for proper ventilation around the exterior of the computer.

-
4. Remove the computer's side access panel and observe the diagnostic LEDs, specifically LED 4 and LED 5 (the CPU A and B Overtemp LEDs). Refer to "[Diagnostic LEDs](#)" in this chapter for more information on how to locate and interpret these LEDs. If either of these LEDs is flashing, this may indicate an initial processor over temperature condition. If either of these LEDs is solidly on, this may indicate a chronic processor over temperature condition. Initial processor over-temperature can cause symptoms such as sluggish computer performance. A chronic processor over-temperature condition can cause the computer to hang completely.
 5. Verify proper processor heat sink installation. (Refer to "[Processor Heatsinks](#)" in the Take Apart chapter for more information.)
 6. Verify all thermal sensors and their cables are properly connected, especially the ambient temperature sensor board.
 7. Verify all fans are operating properly and are unobstructed, especially the front intake fan.

Other Failures

Optical drive

1. Try different optical media.
2. If two drives are installed, check the Master/Slave or Cable Select jumpers on both optical drives (this will depend on drive vendor). Both drives should be set to 'Cable Select' mode for proper operation.
3. If two drives are installed, test one optical drive at a time by disconnecting one of the drives to see if the other one works.
4. Replace optical drive cable
5. Replace optical drive
6. Replace logic board

Front Panel FireWire port

1. Reseat front panel board cables
2. Replace front panel board cables
3. Reseat front panel board
4. Replace front panel board
5. Replace logic board

Rear FireWire port

Replace logic board

Front Panel USB 2.0 port

1. Reseat front panel board cables
2. Replace front panel board cables
3. Reseat front panel board
4. Replace front panel board
5. Replace logic board

Rear Panel USB 2.0 port

Replace logic board

Internal speaker

1. Check speaker cable connection
2. Replace speaker
3. Replace logic board

AirPort Extreme Card

1. Start up the computer from a known-good volume (such as an external hard drive) with AirPort driver software installed, to isolate the issue to software or hardware. If the computer seems to perform adequately when booted in this way, troubleshoot as a software issue. If the computer continues to exhibit the issue, follow the steps below.
2. Reseat antenna cables connected to card
3. Replace card
4. Replace logic board

Bluetooth Card

1. Start up the computer from a known-good volume (such as an external hard drive) with Bluetooth driver software installed, to isolate the issue to software or hardware. If the computer seems to perform adequately when booted in this way, troubleshoot as a software issue. If the computer continues to exhibit the issue, follow the steps below.
2. Reseat antenna cable connected to card.
3. Replace card.
4. Replace logic board.

Audio IO (front headphones)

1. Start up the computer from a known-good volume (such as its Installation disc or an external hard drive), to isolate the issue to software or hardware. If the computer seems to perform adequately when booted in this way, troubleshoot as a software issue. If the computer continues to exhibit the issue, follow the steps below.

-
2. Reseat front panel board
 3. Replace front panel board
 4. Replace logic board

Audio IO (rear audio line in; rear audio line out)

1. Start up the computer from a known-good volume (such as its Installation disc or an external hard drive), to isolate the issue to software or hardware. If the computer seems to perform adequately when booted in this way, troubleshoot as a software issue. If the computer continues to exhibit the issue, follow the steps below.
2. Check Sound settings in System Preferences
3. Replace logic board

Service Source

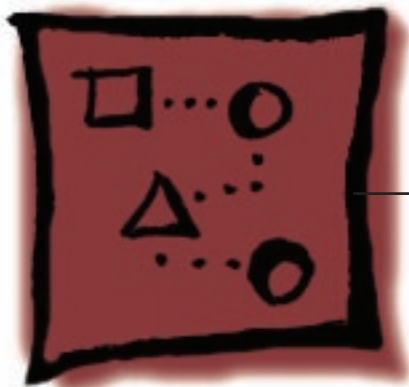

Upgrades

Mac Pro



AirPort Extreme Card

Important: The computer enclosure includes AirPort antenna wires and a Bluetooth antenna wire. The Bluetooth antenna wire looks similar to the AirPort antenna wires, except that it includes a “BT” label. For proper operation, be careful not to connect the Bluetooth antenna wire to the AirPort card or any AirPort antenna wire to the Bluetooth card.

Note: You may connect the AirPort antenna wires to either AirPort card connector.

Tools

The only tool required for this procedure is a magnetized jewelers Phillips #1 screwdriver.

Preliminary Steps

Before you begin, open the computer, and lay it on its side with the access side facing up.

Part Location



Procedure

1. Connect the AirPort antenna wires to the connectors on the card.
Important: Be sure to connect the wires that are marked 1 and 3 to the card; the antenna wire that is marked 2 should be taped out of the way.



2. Insert the AirPort Extreme card into its logic board connector at an angle, as illustrated. Then lower the screw end of the card down to the standoffs on the logic board.

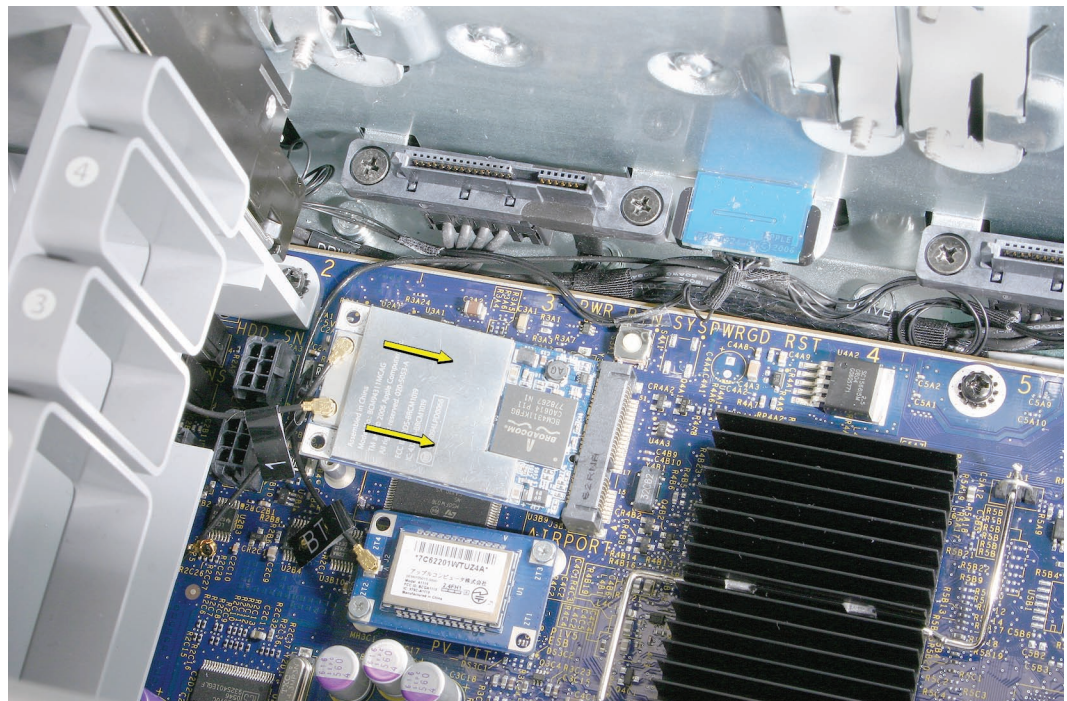

3. Install the two AirPort Extreme card mounting screws.

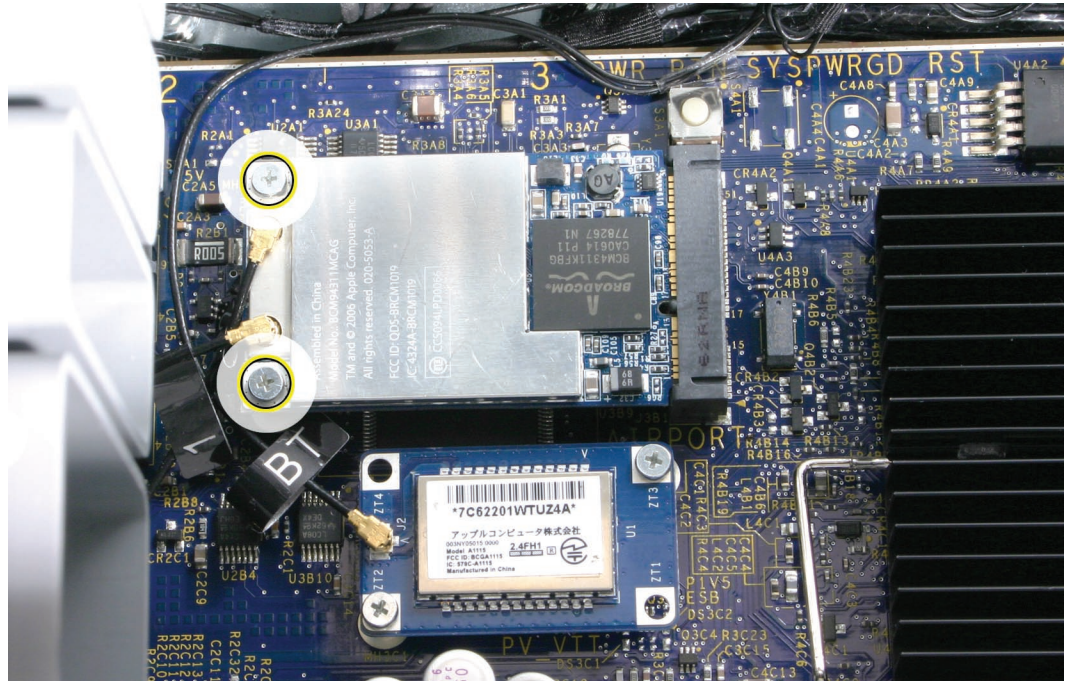



Bluetooth Card

Important: The computer enclosure includes one Bluetooth antenna wire, which looks similar to the AirPort antenna wires, except that it includes a “BT” label. For proper operation, be careful not to connect the Bluetooth antenna wire to the AirPort card or any AirPort antenna wire to the Bluetooth card.

Tools

The only tool required for this procedure is a magnetized jewelers Phillips #1 screwdriver.

Preliminary Steps

Before you begin, open the computer, and lay it on its side with the access side facing up.

Part Location

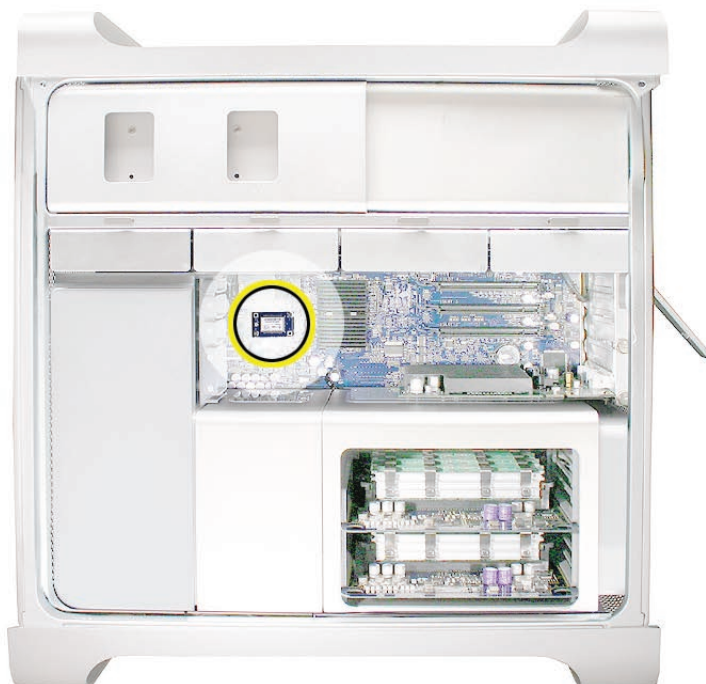

Procedure

1. Connect the Bluetooth antenna wire to the connector on the Bluetooth card.



2. Lower the card onto the Bluetooth connector on the logic board.
3. Install the two Bluetooth card mounting screws.

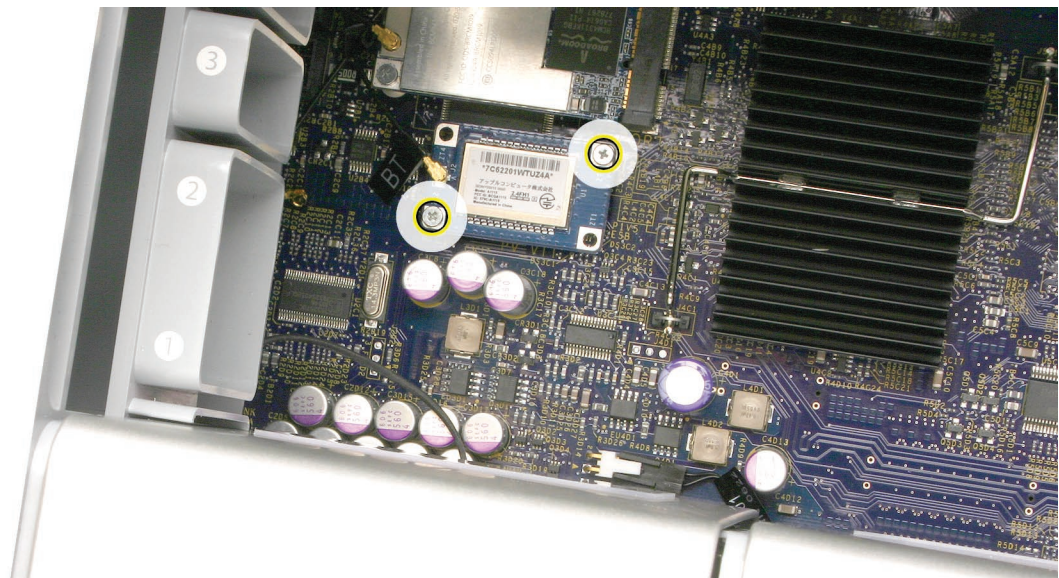



PCI Express/Graphics Card

The Mac Pro logic board includes one double-wide PCI Express graphics slot and three PCI Express expansion slots, for a total of four slots. The computer comes with a graphics card installed in slot 1. You can install additional PCI Express graphics and expansion cards in the remaining three PCI Express expansion slots.

Important: Combined maximum power consumption for all four PCI Express slots must not exceed 300 W.

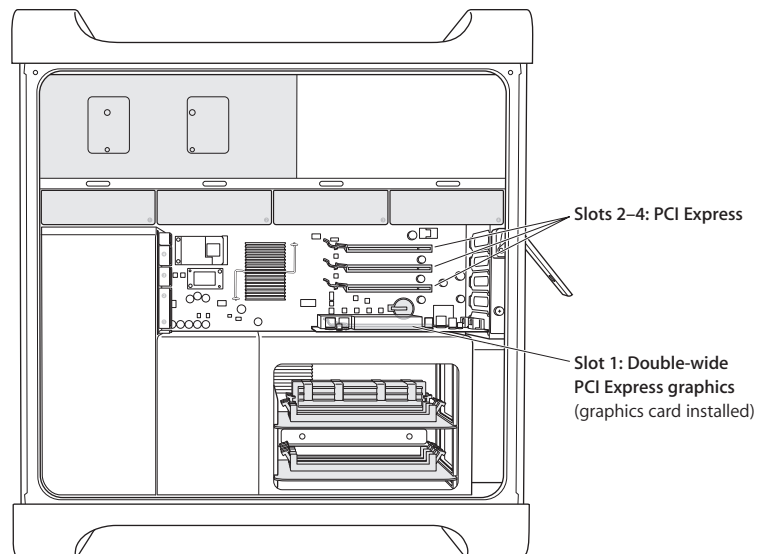

Tools

The only tool required for this procedure is a Phillips #1 screwdriver.

Preliminary Steps

Before you begin, open the computer, and lay it on its side with the access side facing up.

Note: You may also find it helpful to remove the hard drives and carriers and any adjacent PCI Express cards before beginning this procedure.

Part Location



Procedure

This procedure explains how to install a standard card and a card that includes a booster cable. Before you can install either type of card, however, you must first loosen the two captive screws that secure the PCI bracket to the enclosure and remove the bracket. You must also remove the port cover for the PCI slot where you are installing the new card.

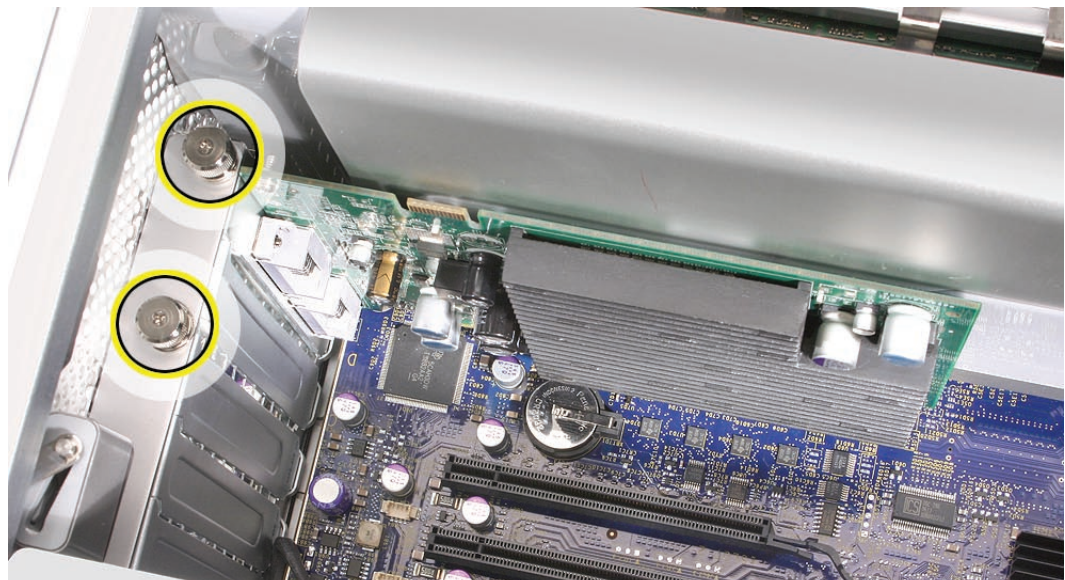

Warning: When installing or removing a card, handle it only by the edges. Do not touch its connectors or any of the components on the card.

Standard Card

1. Align the card's connector with the expansion slot and press until the connector is inserted all the way into the slot. If you're installing a 12-inch card, make sure the card engages the appropriate slot in the PCI card guide.
 - Don't rock the card from side to side; instead, press the card straight down into the slot.
 - Don't force the card. If you meet a lot of resistance, pull the card out. Check the connector and the slot for damage or obstructions, then try inserting the card again.
 - Pull the card gently to see if it is properly connected. If it resists and stays in place and its gold connectors are barely visible, the card is connected.

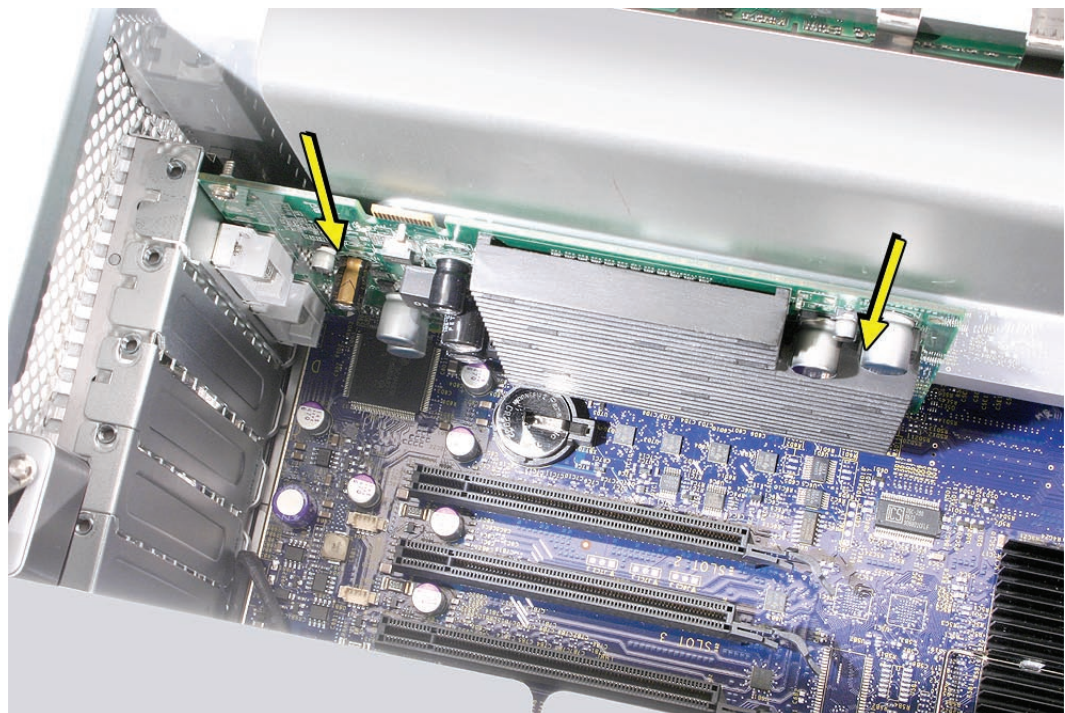

2. Replace the PCI bracket and tighten the two screws that secure it to the enclosure.

Card with Booster Cable

1. Connect the booster cable to the card.

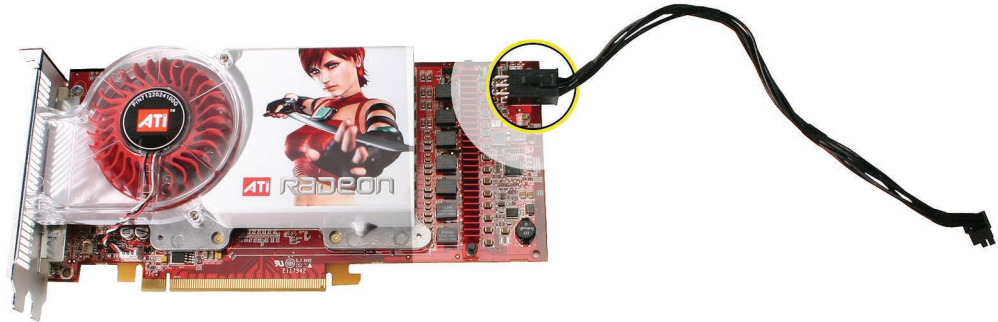

2. Holding the card by the top corners, insert it straight down into its expansion slot.

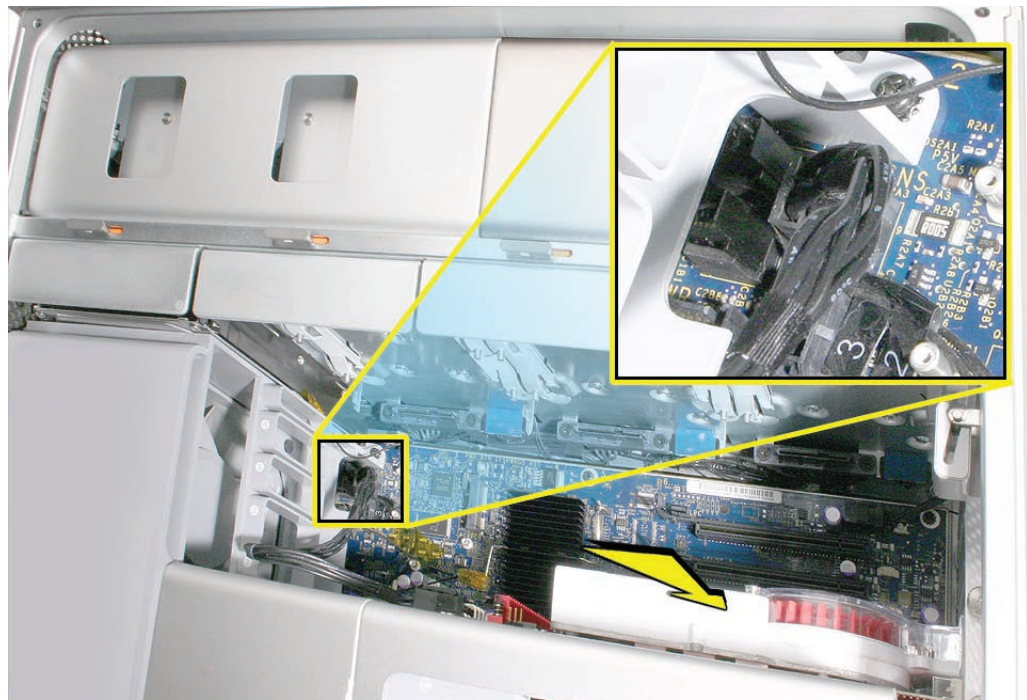

3. Connect the booster cable to the logic board.

Note: There are two logic board connectors for booster cables. Connect the booster cable for a card in PCI slot 1 to the connector that is closest to the heatsink cover. Connect the booster cable for a card in PCI slot 2 to the connector closest to the media shelf.

Service Source



Views

Mac Pro



Exploded View

Exploded View 1

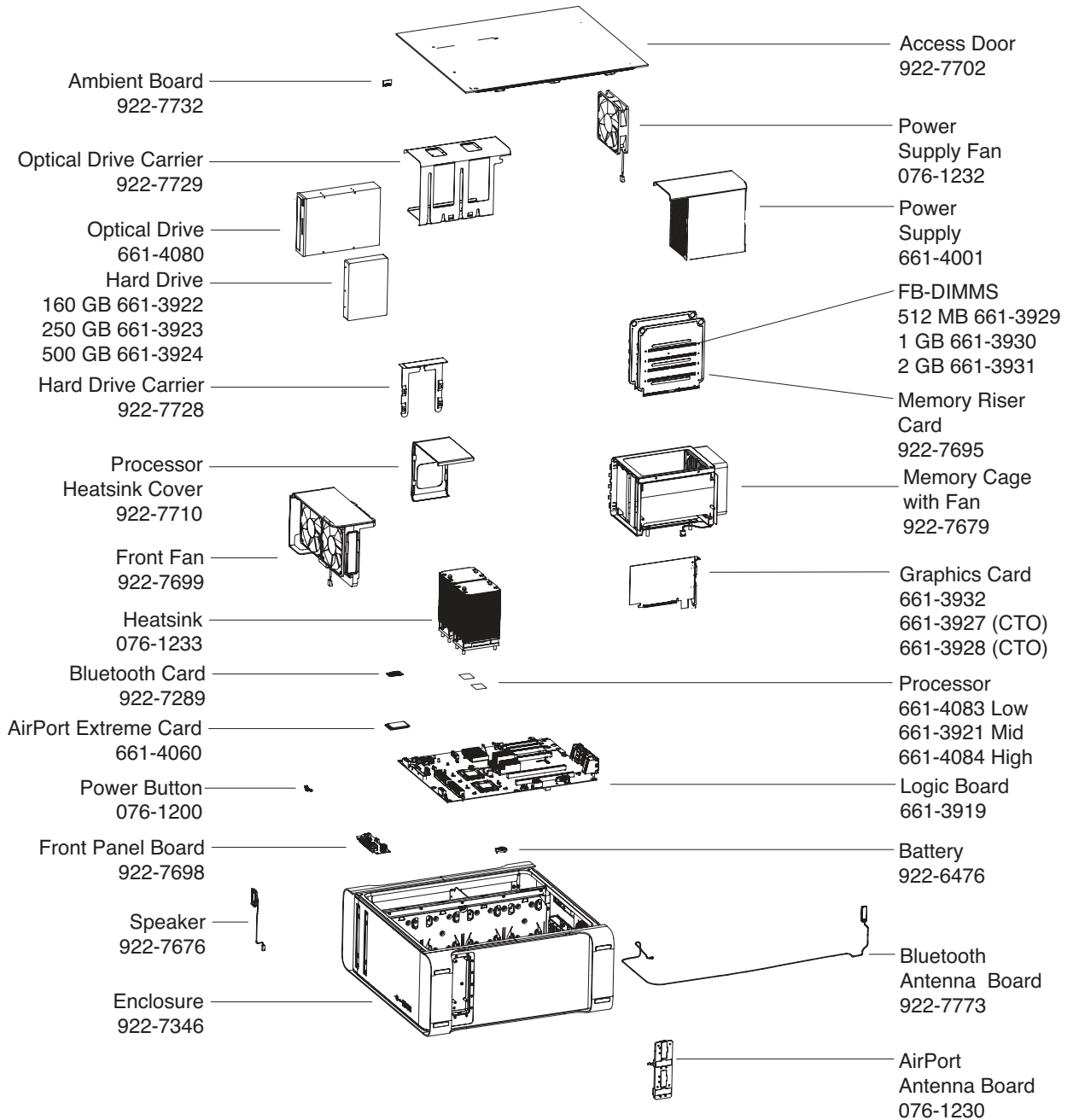

Exploded View 2

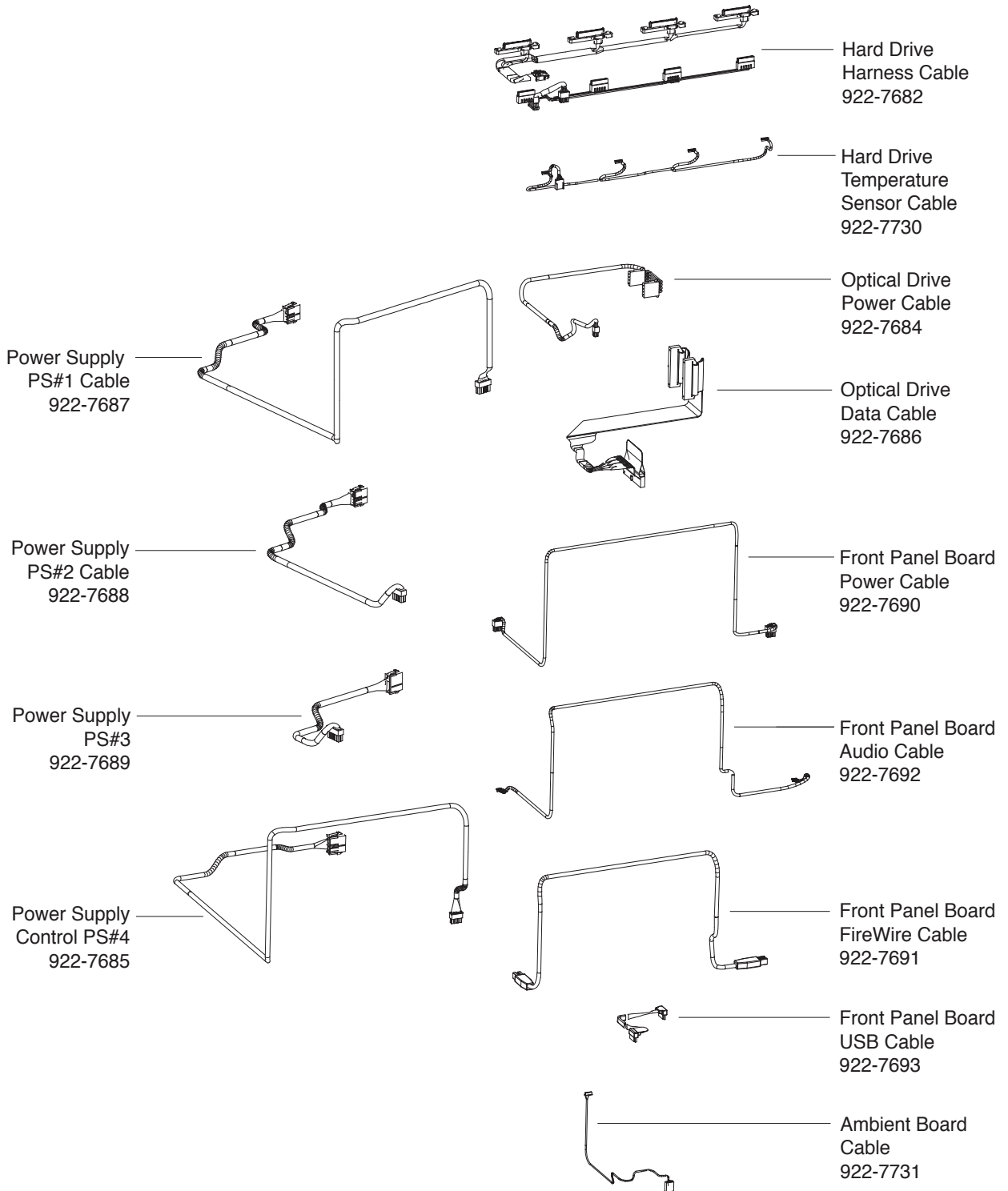



External Views

Front View

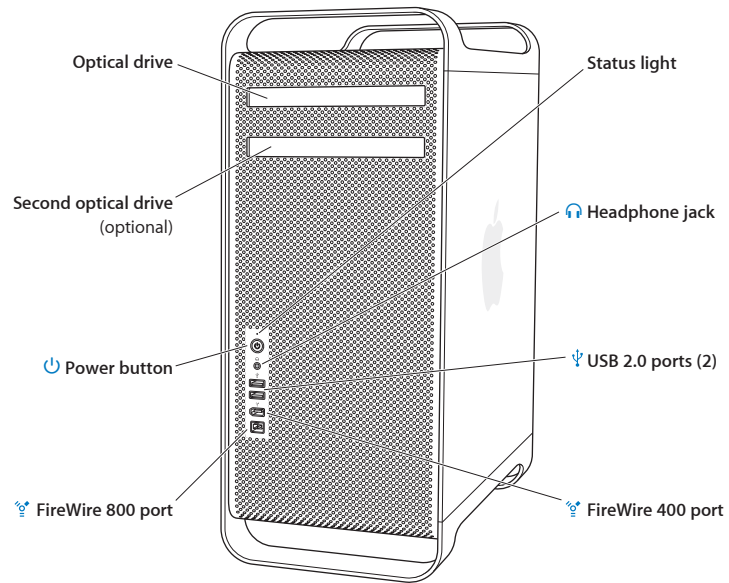

Rear Views

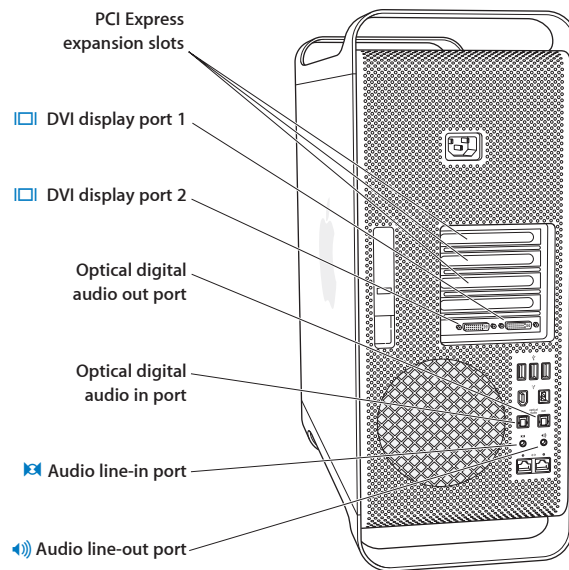
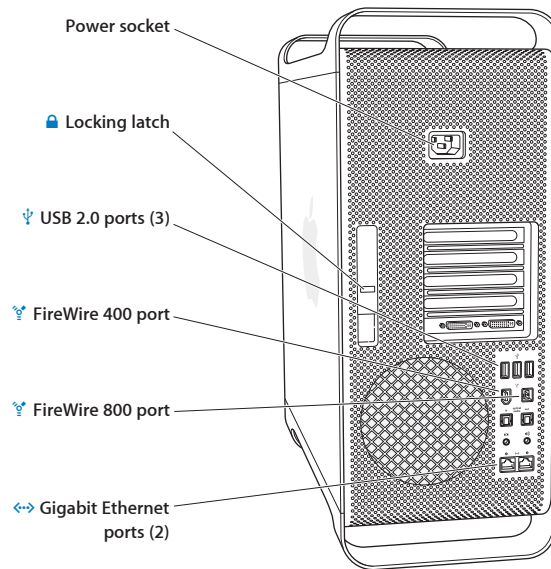

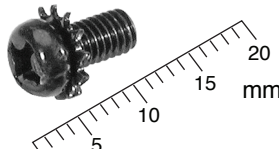
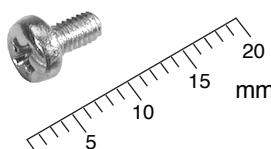
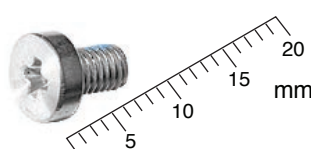
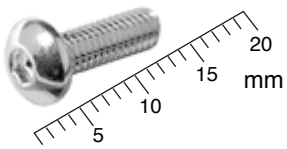
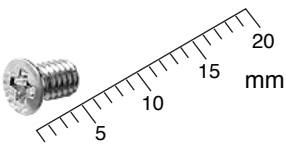
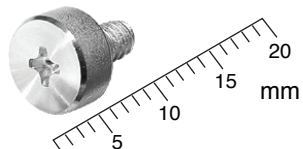
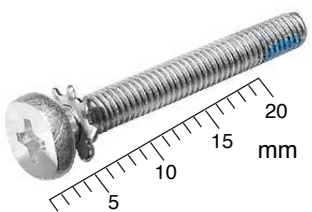
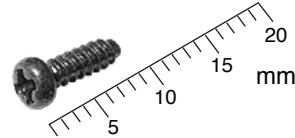

Screw Matrix

<p>922-5974</p>  <p>Logic board, frt panel board, front fan</p>	<p>922-6252</p>  <p>Speaker assembly</p>	<p>922-7703</p>  <p>Memory cage, optical drive</p>
<p>922-7704</p>  <p>Power supply</p>	<p>922-7705</p>  <p>AirPort antenna board</p>	<p>922-7706</p>  <p>Hard drive</p>
	<p>922-7741</p>  <p>Memory cage</p>	<p>922-7756</p>  <p>Speaker</p>