



Mac Pro (8x)

Updated: 4 March 2008

 Apple Inc.

© 2007 Apple Inc. All rights reserved.

Under the copyright laws, this document may not be copied, in whole or in part, without the written consent of Apple.

Every effort has been made to ensure that the information in this document is accurate. Apple is not responsible for printing or clerical errors.

Apple
1 Infinite Loop
Cupertino, CA 95014-2084
USA
+ 1 408 996 1010
www.apple.com

Apple, the Apple logo, and Mac Pro are trademarks of Apple Inc., registered in the U.S. and other countries.

Mac Pro (8x)

Contents

Basics

Overview 7

Identifying the Mac Pro (8x) 8

Serial Number Location 8

GSX Parts 9

Special Handling Instructions 10

Handling Instructions 10

Safety and First Aid Guidelines 11

Disposal Instructions 12

Take Apart

General Information 14

Orientation 14

Tools 14

Differences Between the Original Mac Pro and Mac Pro (8x) 14

Opening the Computer 16

Hard Drives 18

Optical Drive Carrier and Optical Drives 21

Memory (FB-DIMMs) and Memory Riser Cards 25

PCI Express/Graphics Card 29

Power Supply 34

Power Supply Fan 38

AirPort Extreme Card 43

Bluetooth Card 46

Battery 48

Processor Heatsink Cover 50

Front Fan Assembly	53
Mac Pro RAID Card and Battery	58
Memory Cage with Rear Fan	64
Processor Heatsinks	69
Processors	78
Speaker Assembly	83
USB Cable	86
Logic Board	88
Front Panel Board	96
Power Button	100
AirPort Antenna Board with Cables	104
Optical Drive Power Cable	108
Optical Drive Data (Ribbon) Cable	111
Ambient Board	113
Ambient Board Cable	115
Bluetooth Antenna Board and Cable	117
Hard Drive Cable Harness	120
Hard Drive Temperature Sensor Cable	122
Hard Drive Temperature Sensor	124
Power Cable Harness	127

Troubleshooting

General Information	133
Memory	133
PCI Express Cards	134
Internal Cabling Matrix	134
Thermal Calibration	136
Resetting the Logic Board	137
Power-On Self Test: RAM and Processor Verification	138
Diagnostic LEDs	139
Power Supply Verification	144

Mac Pro Firmware Updates 144
Processor Heatsink and Processor Visual Inspection Instructions 146

Symptom Charts 149
 How to Use the Symptom Charts 149
 Startup Failures 149
 Fans 152
 AirPort Extreme Card 153
 Bluetooth Card 154
 Other Failures 154

Upgrades

AirPort Extreme Card 158
Bluetooth Card 161
PCI Express/Graphics Card 163

Views

Exploded Views 168
External Views 170
Screw Matrix 172



Basics

Mac Pro (8x)



Overview

The Mac Pro (8x) is the high-end configuration of the original Mac Pro and shares the same form factor. However, the Mac Pro (8x) configuration features two quad-core Intel Xeon processors, effectively making it an 8x-processor computer.





Identifying the Mac Pro (8x)

To identify a Mac Pro (8x) computer, check the computer's configuration label, which is located on the computer's back panel directly below the video ports. Two numbers on the configuration label identify the computer as a Mac Pro (8x):

- On the first line of the label, the EMC number is listed as "2138"
- On the second line, the configuration description includes "3.0_8cx"

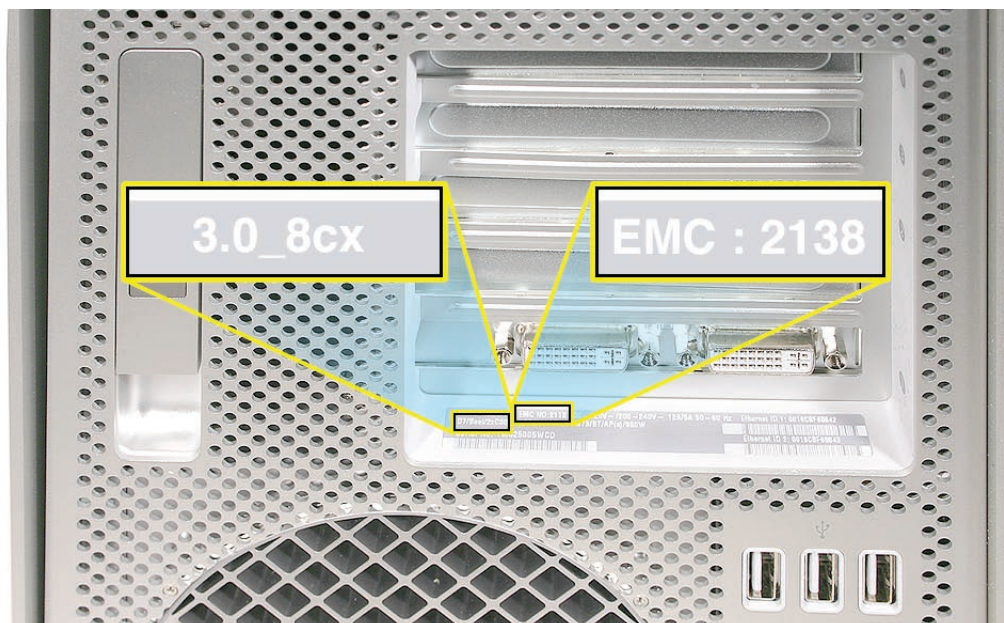

Serial Number Location

The Mac Pro (8x) serial number is located on the configuration label, directly below the configuration description.



GSX Parts

Because Mac Pro (8x) is a product configuration of the original Mac Pro, Mac Pro (8x) computers do not have serial numbers distinct from Mac Pro serial numbers. There is also no separate Mac Pro (8x) product pull-down list in GSX.

When using a computer's serial number to look up Mac Pro (8x) parts in GSX, be aware that you will receive a list of parts for both Mac Pro and Mac Pro (8x). Parts that are unique to Mac Pro (8x) will have "8x" included at the end of the part description. Parts without "8x" in the description may be either a) parts unique to the original Mac Pro or b) parts used in both the original Mac Pro and Mac Pro (8x). To verify that a particular part is used in the Mac Pro (8x), check the GSX "Notes" field for the part or the ["Exploded View"](#) diagrams in the Views chapter.



Special Handling Instructions

The Mac Pro (8x) configuration uses a special coating on the processor heatsink and processor to manage the temperature in the computer. To ensure proper handling and disposal of this material, please read the following information.

Handling Instructions

Use these guidelines when handling the Mac Pro (8x) processor heatsink and processor:

General

- Wear disposable nitrile or latex gloves when handling the processor heatsink and processor.
- Avoid touching the silver coating on the underside of the heatsink and the top of the processor.
- Use care when removing the heatsink from the computer. As much as possible, lift the heatsink straight up off the processor.
- Use care when removing the processor from the logic board. Lift the processor out of the processor holder by inserting a finger or flatblade screwdriver in the notch at the front of the holder. Hold the processor only by the edges.
- When installing a replacement heatsink or processor, remove the protective cover from the new heatsink or processor and transfer it to the defective heatsink or processor before packaging it for return to Apple.

Timing

- When removing or replacing the heatsink and/or processor, do not allow the heatsink to be separated from the processor for more than 30 minutes. The silver coating on the heatsink and processor degrades with exposure to air; more than 30 minutes exposure could result in damage to the computer and a repeat, multi-part repair. Reassemble the computer while waiting for any new parts to arrive.
- When installing a new logic board, use care in transferring the heatsinks and processors to the new board. Do not allow the heatsinks and processors to be separated from the board or from each other for more than 30 minutes. Reassemble the computer while waiting for a new logic board to arrive.



Visual Inspection

- Always make a visual inspection of a new processor or heatsink before installing it in the computer.
- Always make a visual inspection of both existing processors and heatsinks before transferring them to a new logic board.
- See "[Processor Heatsink and Processor Visual Inspection Instructions](#)" in the Troubleshooting chapter for more information.

Krytox Thermal Grease

- To ensure a proper seal between the heatsink and processor, a bead of Krytox grease rims the gasket on the underside of the heatsink. Replacement heatsinks come with the grease already applied.
- Use the following guidelines for when to reapply Krytox grease to the heatsink. (Refer to [“Processor Heatsinks”](#) in the Take Apart chapter for detailed instructions on how to apply or clean off the grease.)
 - In most cases, you do not need to reapply Krytox grease when installing a new processor or when transferring processors and heatsinks to a replacement logic board.
 - If you are installing a new heatsink, remove any residual grease from the outer edges of the processor. Do not apply new grease to the heatsink or processor, as the heatsink comes with the full capacity of grease applied.

For more detailed information, refer to [“Processor Heatsinks”](#) and [“Processors”](#) in the Take Apart chapter.

Safety and First Aid Guidelines

Below is a summary of safety and first aid measures for exposure to the coating on the processor heatsink and processor or the Krytox grease used in sealing the processor heatsink to the processor. For complete instructions, refer to the specific Material Safety Data Sheets (MSDS) included with the replacement parts.

Safety

Avoid contact with eyes.

Avoid contact with skin.

Wash thoroughly after handling.

Do not store or consume food, drink, or tobacco in areas where they may become contaminated with the material.

First Aid

Eyes: Immediately flush with plenty of water. If wearing contact lenses, after initial flushing, remove contact lenses and continue to flush for 15 minutes. Have eyes examined by a medical professional if irritation persists.

Skin: Wash skin with soap and running water. The recommended flushing is 15 minutes if pain or irritation occurs. Remove and wash contaminated clothing. Seek medical attention if irritation or redness develops.

Inhalation: Remove to fresh air. If not breathing, give artificial respiration. If breathing is difficult, give oxygen. Call a physician.

Ingestion: Do not induce vomiting. Contaminated individual should immediately be given two glasses of water. Never give anything by mouth to someone who is unconscious, having convulsions, or unable to swallow. Call a physician.

Disposal Instructions

Place all disposable materials used in removing or replacing a processor heatsink or processor inside the resealable plastic bag included with the replacement module. (Disposable materials include such items as protective gloves, alcohol wipes, lint-free cleaning cloths, Krytox grease and syringe, and heatsink gasket.) Pack this bag along with the failed module in the box that the replacement module came in, and return the box to Apple.



Take Apart
Mac Pro (8x)



General Information

Orientation

For most take-apart procedures, it is recommended that you lay the computer on its side before removing or installing the part. For proper operation, however, Apple recommends that the unit be run in the upright position. The computer should never be operated on its side with the access panel facing down.

Tools

The following tools are required to service all configurations of the computer:

- Long-handled magnetized Phillips #1 screwdriver
- Long-handled magnetized 3 mm flathead hex screwdriver
- Short-handled, magnetized 2.5 mm hex wrench
- Flat-blade screwdriver
- Magnetized jewelers Phillips #1 screwdriver
- Magnetized jeweler's Phillips #0 screwdriver
- Jeweler's flat-blade screwdriver
- Needlenose pliers
- Scissors or wire cutters
- Xacto knife
- Nylon probe tool (black stick)
- Thermal grease kit (Apple part number 076-1258)
- Tape (for temporarily holding cables out of the way)
- Small mirror (for seeing small boards inside the enclosure)
- Soft cloth (for protecting the enclosure from scratches)

Differences Between the Original Mac Pro and Mac Pro (8x)

The following are differences in the take-apart procedures for the Mac Pro (8x), as compared with earlier Mac Pro configurations. (For detailed information, be sure to refer to the full procedure for each part.)

Power Supply

The power supply cables are located under a cover at the back wall of the optical drive bay. This change simplifies access to the cable connectors and makes removal of the power supply easier.

Power Supply Fan

Fully removing the power supply is a preliminary step for removing the power supply fan. The simplified procedure for removing the power supply therefore simplifies removal of the power supply fan.

Processor Heatsink Cover

When removing the heatsink cover, you no longer have to make room by removing the memory cage screws and sliding the memory cage toward the back of the computer. The heatsink cover is held in place with tabs and magnets and comes off easily without any tools.

Front Fan Assembly

The front fan assembly is held in place by two screws: one at the top rear of the assembly that mounts the assembly to the logic board and a new screw at the bottom front of the assembly. Once these screws are removed, the front fan assembly can easily be lifted out of the enclosure.

Memory Cage with Rear Fan

The only parts that must be removed before removing the memory cage are the top and bottom memory cards, any PCI Express card installed in slot 1, and the processor heatsink cover. The rear fan collapses into the cage, which simplifies removal of the cage and fan. In addition, the rear fan can be removed from the memory cage and is therefore a separate, orderable part.

Processor Heatsinks and Processors

A special coating that helps manage the temperature of the computer comes applied to the underside of the heatsink and the top of the processor. As a result, several new guidelines are necessary for handling the heatsink and processor.

Logic Board

Eleven screws secure the logic board to the enclosure. Previous Mac Pro configurations used eight screws.

Bluetooth Antenna Board and Cable

Because the Bluetooth antenna board cable runs under the logic board, you must remove the logic board before removing the antenna board and cable.

Parts Requiring Enclosure Replacement

The following are not separate, orderable parts. To replace them, you must replace the enclosure.

- Media shelf
- Rear panel latch



Opening the Computer

Tools

No tools are required for this procedure.

Preliminary Steps

1. Shut down the computer.
Warning: Always shut down the computer before opening it to avoid damaging its internal components or the components you are installing. Do not open the computer or attempt to install items inside it while it is on.
2. Wait 5 to 10 minutes to allow the computer's internal components to cool.
Warning: After you shut down the system, the internal components can be very hot. You must let the computer cool down before continuing.
3. Unplug all external cables from the computer except the power cord.
4. Touch the metal PCI access covers on the back of the computer to discharge any static electricity from your body.
Important: Always discharge static before you touch any parts or install any components inside the computer. To avoid generating static electricity, do not walk around the room until you have finished working and closed the computer.
5. Unplug the power cord.
Warning: To avoid damaging its internal components or the components you want to install, always unplug the computer before attempting any take-apart procedure.
6. Put on an ESD wrist strap.

Procedure

1. Hold the side access panel and lift the latch on the back of the computer.
Warning: The edges of the access panel and the enclosure can be sharp. Be very careful when handling them.
2. Remove the access panel and place it on a flat surface covered by a soft, clean cloth.
Replacement Note: Make sure the latch is in the up position before replacing the access panel. If the latch is down, the access panel will not seat correctly in the enclosure.

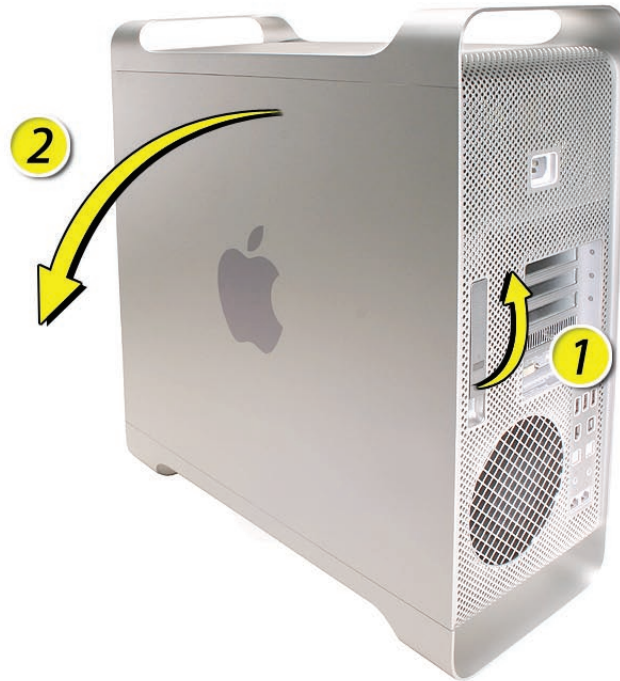



Hard Drives

The Mac Pro (8x) computer can accommodate four serial ATA (SATA) 3 Gbps hard drives in its four internal hard drive bays. In most configurations, a single hard drive occupies the far left bay (bay 1).

The hard drives must meet the following specifications:

- Type: SATA 3 Gbps
- Width: 3.9 inches (102 mm)
- Depth: 5.7 inches (147 mm)
- Height: 1.0 inch

Tools

The only tool required for this procedure is a Phillips #1 screwdriver.

Preliminary Steps

Before you begin, open the computer, and lay it on its side with the access side facing up.

Important: Make sure the latch on the back panel is in the up position. When the latch is down, the hard drives and carriers are locked in place and you will not be able to remove them.

Part Location

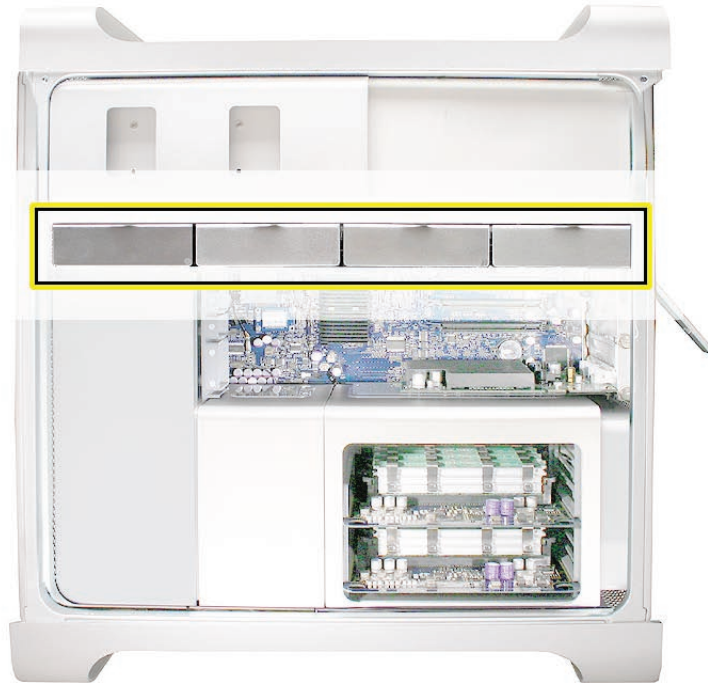

Procedure

1. Make sure the latch on the back panel is up, so that the drives and carriers are unlocked.
2. Pull the hard drive out of the drive bay.

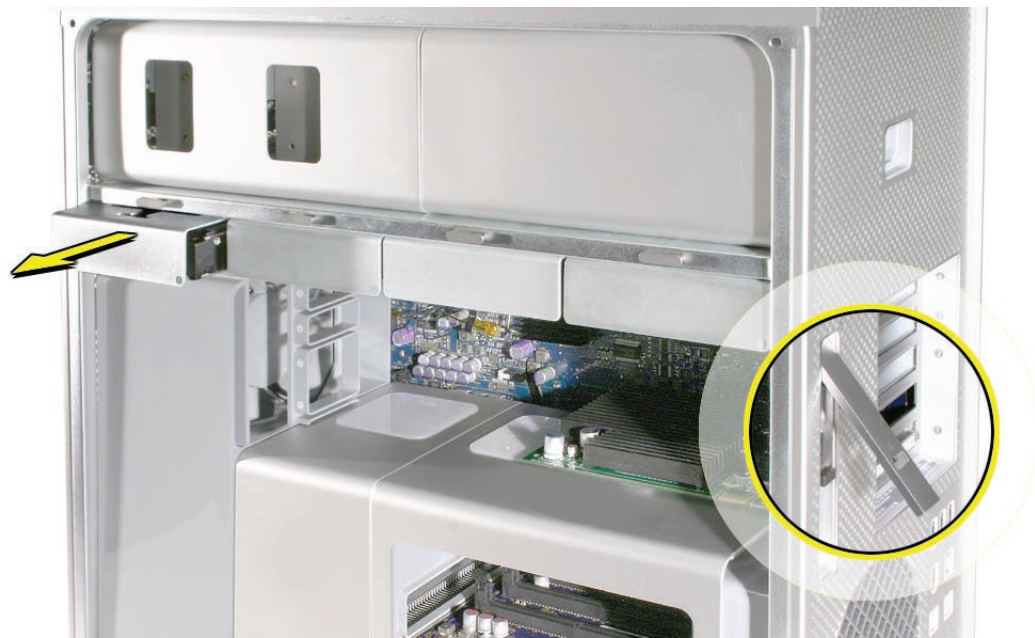

-
3. If you are replacing the hard drive with a new drive, remove the four screws that mount the drive to the carrier and mount the new drive in the carrier.

Important: Hold the drive by its sides. Be careful not to touch the printed circuit board on the bottom of the drive.



Replacement Note: Slide the carrier and drive over the guides and into the drive bay, until you feel the drive snap into place.

Note: If you install a new (replacement) drive, format it by following these steps:

1. Open Disk Utility and select the drive in the list to the left.
Note: If you are formatting the primary drive, use the Disk Utility program on the Install Disk.
2. Click on the Partition tab.
3. Click on “Options” and verify GUID is selected if this is a bootable drive.
4. Apply the change by clicking on the “Partition” button.



Optical Drive Carrier and Optical Drives

The Mac Pro (8x) computer can accommodate two optical drives in the optical drive bay. If the computer has only one optical drive, it is installed in the top position.

Note: To eject the drives, use the following:

- Top drive: Press the Eject key.
- Bottom drive: Press the Option and Eject keys.

Tools

The only tool required for this procedure is a Phillips #1 screwdriver.

Preliminary Steps

Before you begin, open the computer, and lay it on its side with the access side facing up.

Important: Make sure the latch on the back panel is in the up position. When the latch is down, the optical drives and carrier are locked in place and you will not be able to remove them.

Part Location

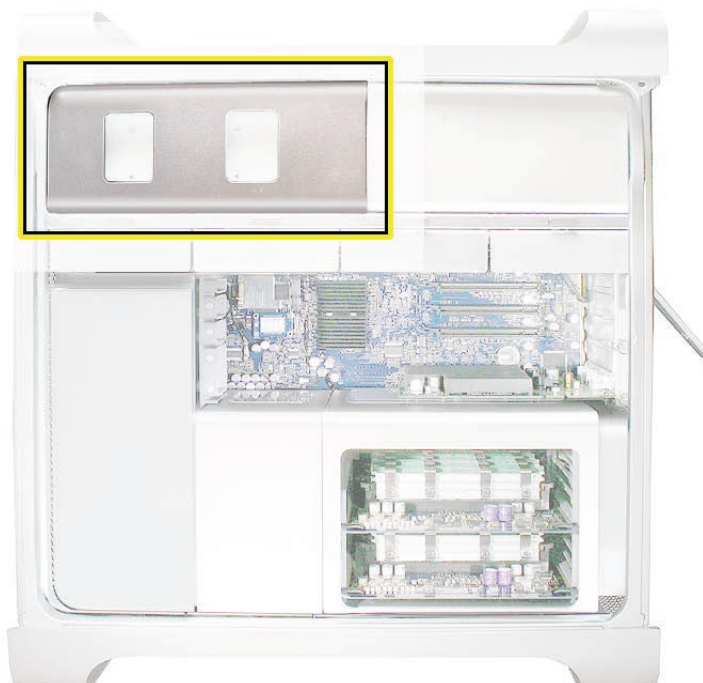

Procedure

Removing the Optical Drive Carrier and Optical Drives

1. Make sure the latch on the back panel is up, so that the drives and carriers are unlocked.

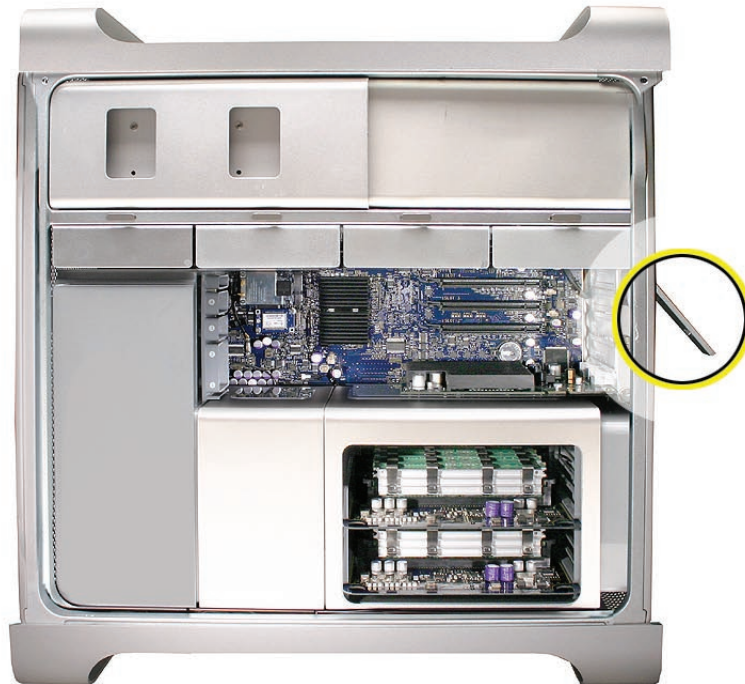

2. Pull the optical drive carrier part way out of the computer.



3. Disconnect the power and ribbon cables from the optical drive(s) and remove the carrier.

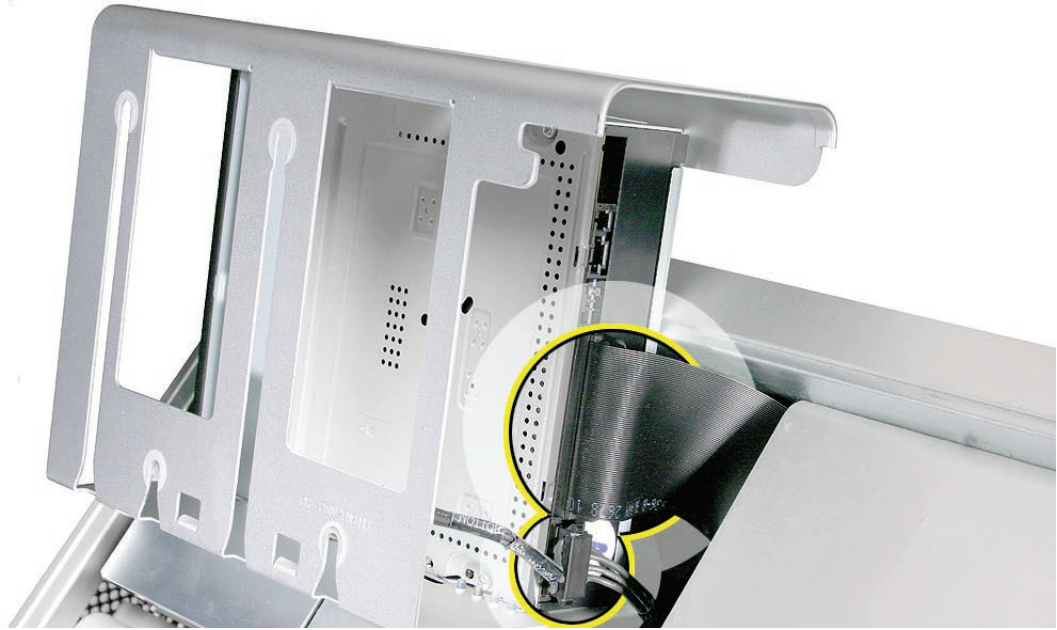

4. If you are replacing the optical drive with a new optical drive, do the following:
 - Remove the four mounting screws and remove the optical drive from the carrier.
 - Use the four screws to mount the replacement drive in the carrier.

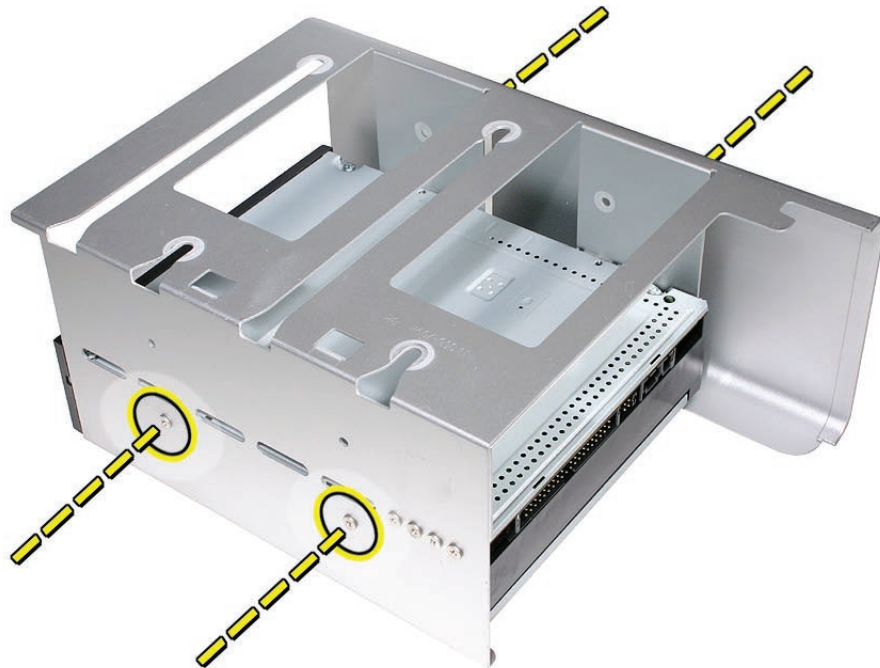

Note: If you are adding a second drive to the carrier, use the four screws stored on the back of the drive carrier to secure the drive to the carrier.

Replacing the Optical Drive Carrier and Optical Drives

Important: Use the original Apple cables that came with the computer when you install or replace the optical drives. If just one optical drive is installed, tuck the cables for the second drive out of the way.

1. Attach the power and ribbon cables to the back of the drive(s).

Important: Attach the connector on the end of the optical drive ribbon cable and the connector in the middle of the optical drive power cable to the top drive. If there is a second drive in the carrier, attach the remaining optical drive ribbon and power connectors to the bottom drive.



2. Slide the optical drive carrier over the guides and into place in the optical drive bay.

Important: Be very careful not to catch the cables under the carrier as you slide it into the bay.



Memory (FB-DIMMs) and Memory Riser Cards

The Mac Pro (8x) computer has two memory riser cards with a total of 8 memory slots. On each card, the slots are arranged as two banks of two slots each. The computer comes with a minimum of 1 GB of memory, installed as a pair of 512 MB fully buffered, dual inline memory modules (FB-DIMMs) in two of the DIMM slots. Additional DIMMs can be installed in the open DIMM slots, as illustrated below.

Note: DIMMs must be installed in pairs of equal size from the same vendor. In the illustration below, DIMMs in one colored pair do not need to match DIMMs in a different colored pair.

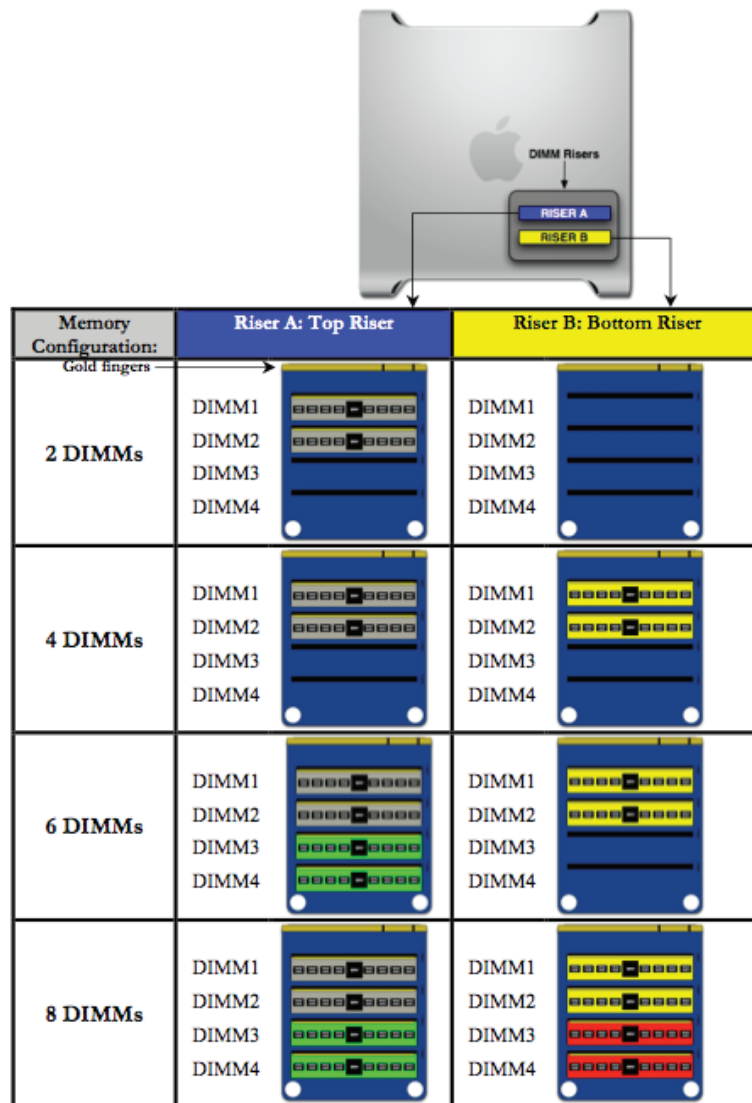

DIMMs for Mac Pro (8x) must fit these specifications:

- 667 MHz, FB-DIMMs
- 72-bit wide, 240-pin modules
- 36 devices maximum per DIMM
- Error-correcting code (ECC)

Memory from older Macintosh computers is not compatible with Mac Pro (8x).

Important: For proper operation of Mac Pro (8x) computers, Apple recommends using only Apple-approved Mac Pro (8x) FB-DIMMs. Refer to GSX for Apple FB-DIMMs service part numbers.

Tools

No tools are required for this procedure.

Preliminary Steps

Before you begin, open the computer, and lay it on its side with the access side facing up.

Warning: Always wait 5–10 minutes for the computer to cool down before you remove or install memory. The DIMMs may be very hot.

Part Location

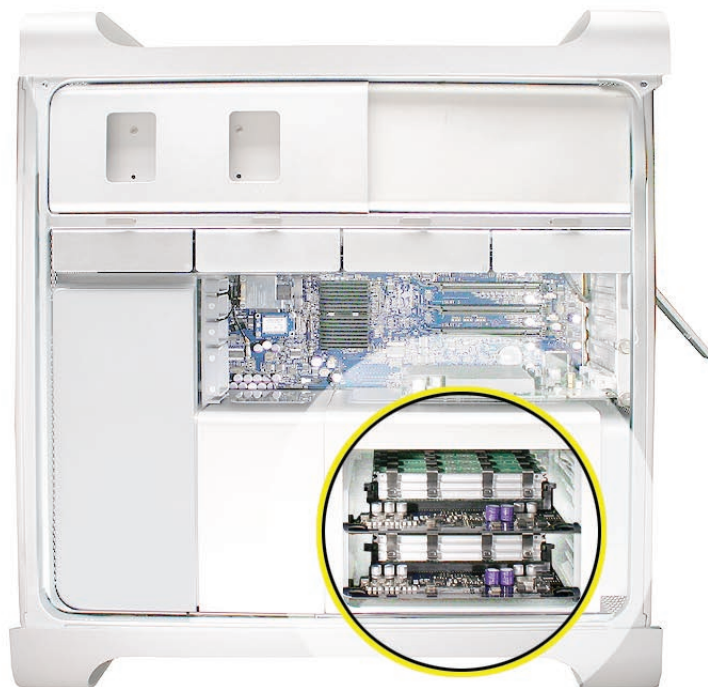

Procedure

1. Holding the memory riser card by the two finger holes, pull it out of the memory cage and place the card DIMM side up on a soft, clean cloth.

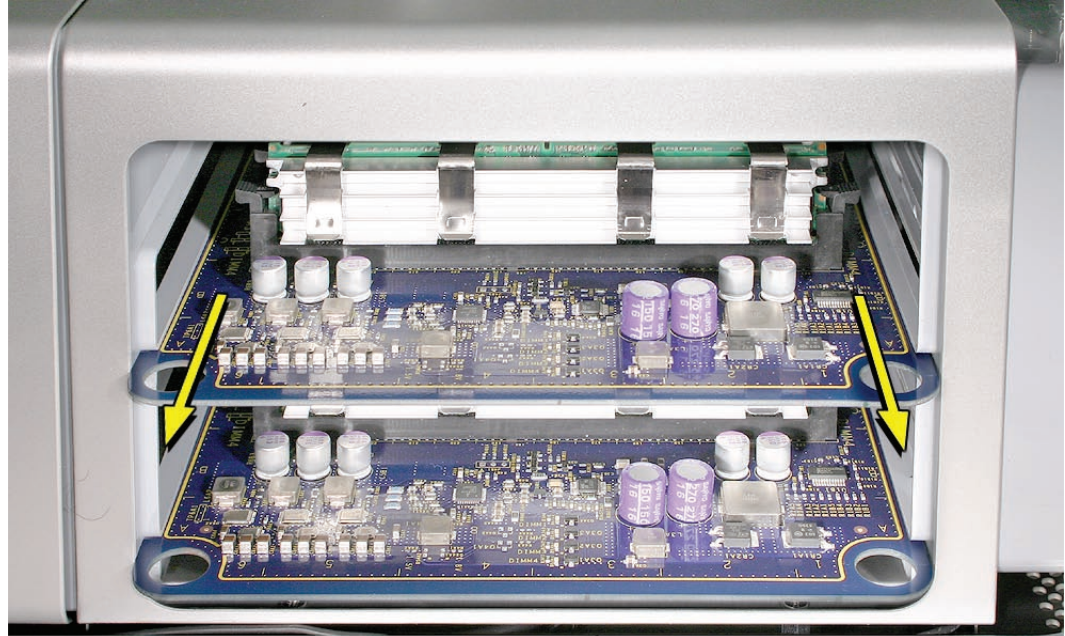

2. Open the ejectors on the DIMM slot by pushing them out to the sides, and remove the DIMM from the riser card.

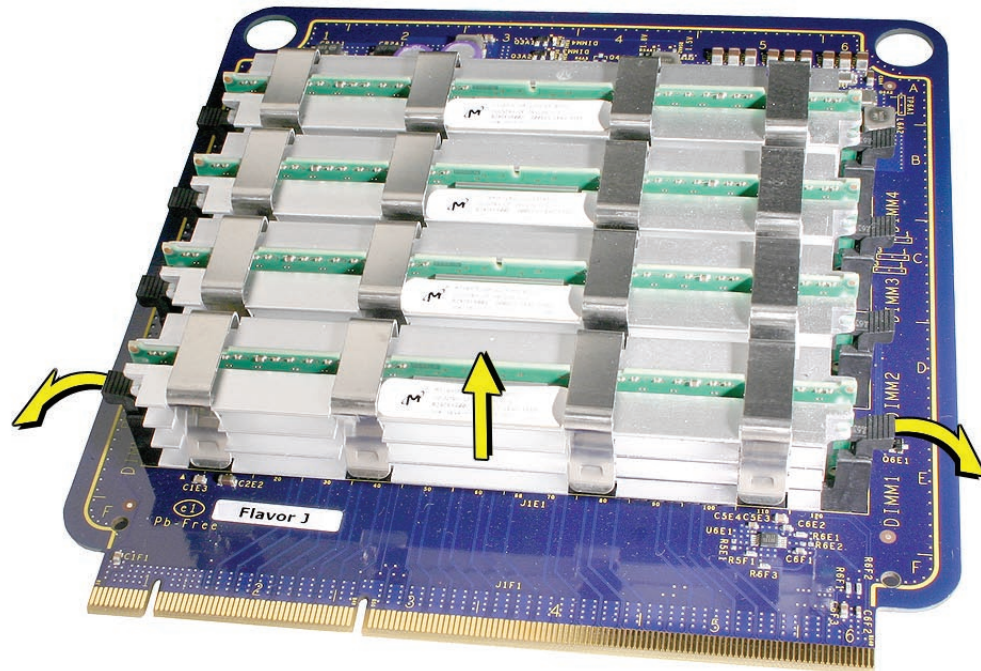

Replacement Note: Align the DIMM in the slot on the riser card and push both ends of the DIMM down until the ejectors snap back up into place.

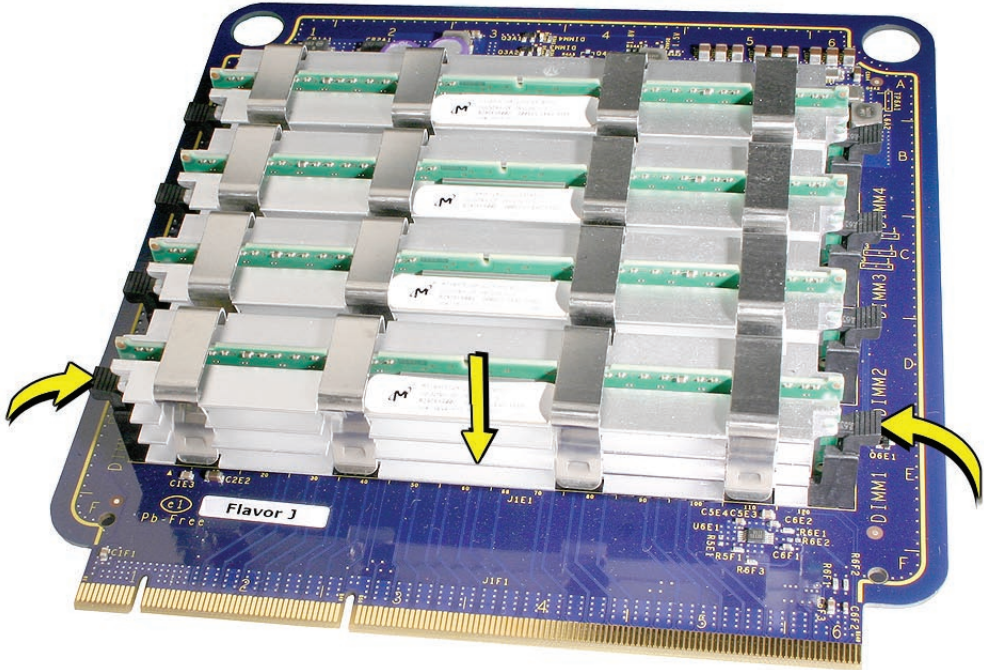

Warning: FB-DIMMs carry heatsinks on either side of the DIMM. Never attempt to remove the heatsinks from the DIMMs. Doing so could damage the DIMM.

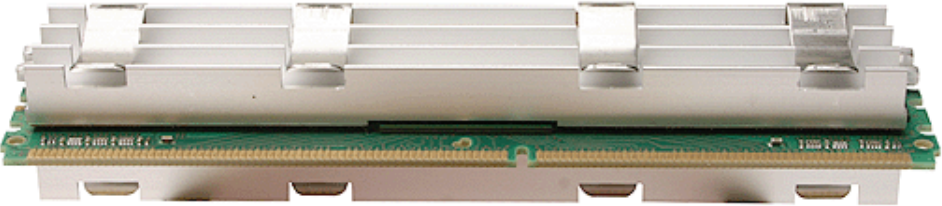



PCI Express/Graphics Card

The Mac Pro (8x) logic board includes one double-wide PCI Express graphics slot and three PCI Express expansion slots, for a total of four slots. The computer comes with a graphics card installed in slot 1. You can install additional PCI Express graphics and expansion cards in the remaining three PCI Express expansion slots.

Important: Graphics cards from previous Power Mac G5 models are not compatible with Mac Pro (8x) models. In addition, Mac Pro (8x) graphics cards are not compatible with previous models.

Important: Combined maximum power consumption for all four PCI Express slots must not exceed 300 W.

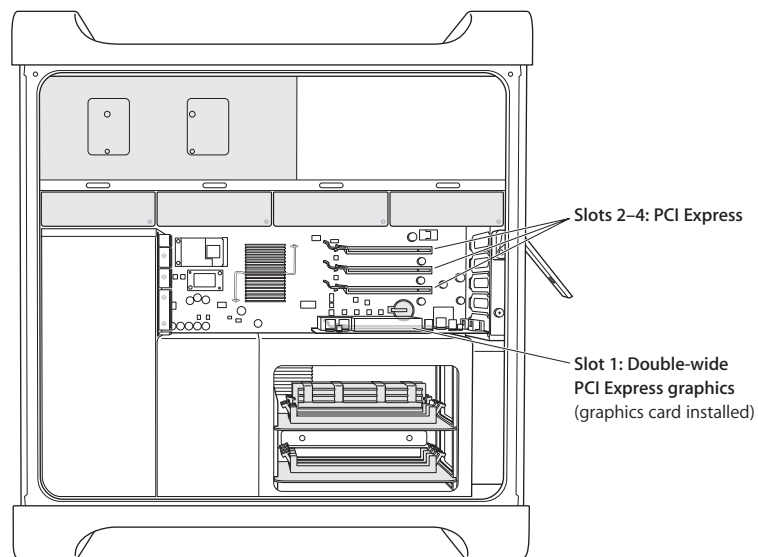

Tools

The only tool required for this procedure is a Phillips #1 screwdriver.

Preliminary Steps

Before you begin, open the computer, and lay it on its side with the access side facing up.

Note: You may also find it helpful to remove the [hard drives and carriers](#) and any adjacent PCI Express cards before beginning this procedure.

Part Location



Procedure

This procedure explains how to remove a standard card and a card that includes a booster cable. Before you can remove either type of card, however, you must first loosen the two captive screws that secure the PCI bracket to the enclosure and remove the bracket.

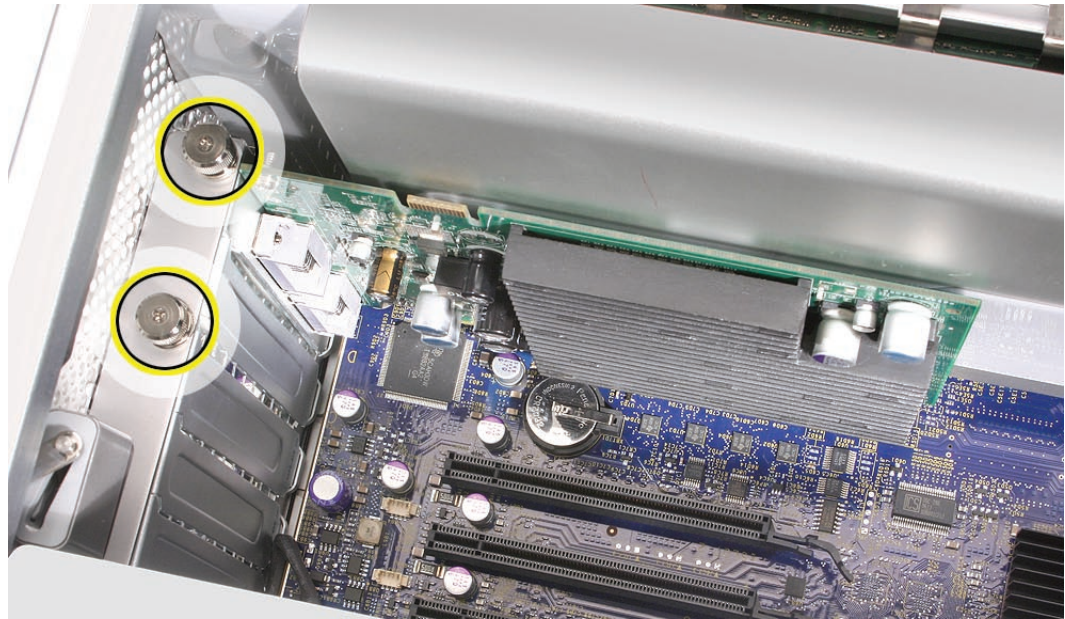

Warning: When removing or installing a card, handle it only by the edges. Do not touch its connectors or any of the components on the card. Lift the card straight out from the connector to remove it, and insert it straight into the connector to install it. Do not rock the card from side to side and don't force the card into the slot. Once the replacement card is installed, pull on it gently to check that it is properly connected.

Standard Card

1. Release the small locking clip at the front of the card's logic board connector by pushing the clip up toward the media shelf.
2. Holding the card by the top corners, pull up the card and remove it from its expansion slot.

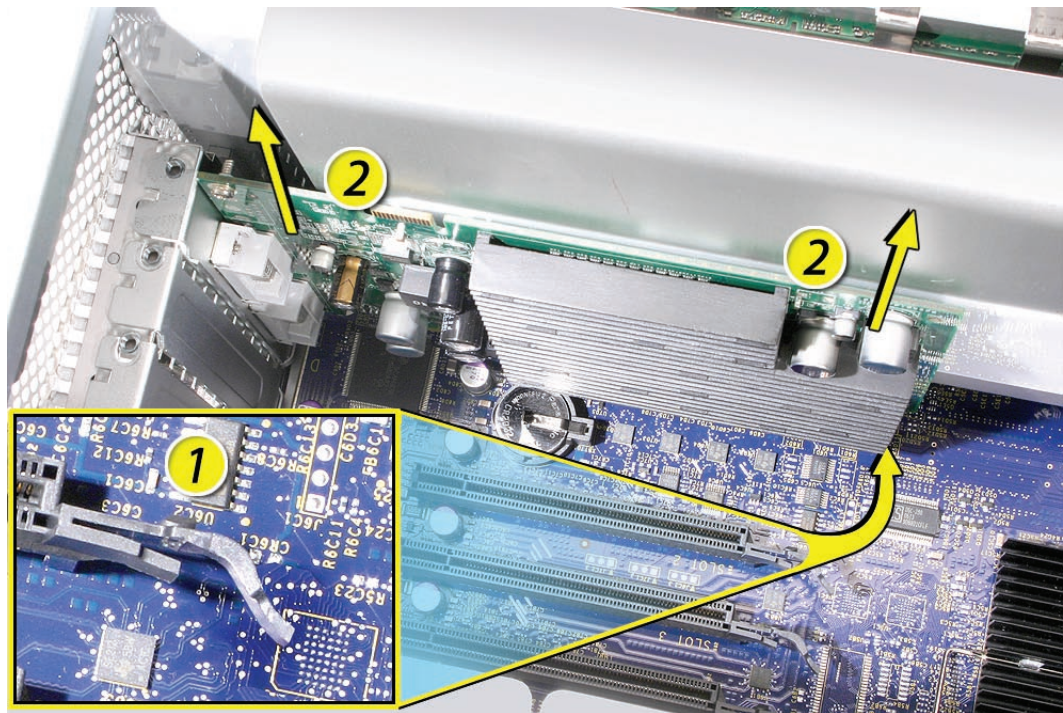

Replacement Note: Align the card's connector with the expansion slot and press until the connector is inserted all the way into the slot. If you're installing a 12-inch card, make sure the card engages the appropriate slot in the PCI card guide.

- Don't rock the card from side to side; instead, press the card straight into the slot.
- Don't force the card. If you meet a lot of resistance, pull the card out. Check the connector and the slot for damage or obstructions, then try inserting the card again.
- Pull the card gently to see if it is properly connected. If it resists and stays in place and its gold connectors are barely visible, the card is connected.

Card with Booster Cable

1. Disconnect the booster cable from the logic board.
2. Release the small locking clip at the front of the card's logic board connector by pushing the clip up toward the media shelf.
3. Holding the card by the top corners, gently pull up the card and remove it from its expansion slot.

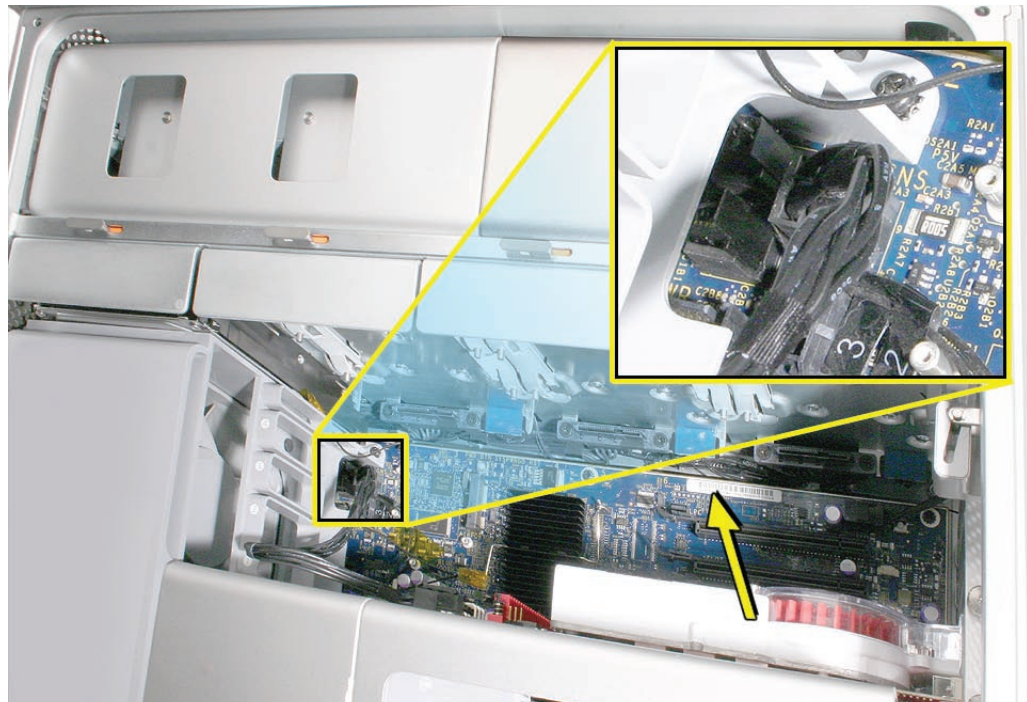

4. If you are replacing the booster cable with a new booster cable, disconnect the cable from the card.

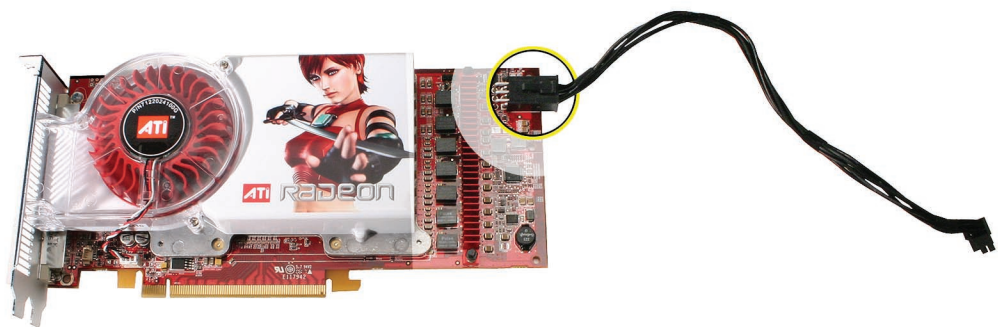

Replacement Note: There are two logic board connectors for booster cables. Connect the booster cable for a card in PCI slot 1 to the lower connector. Connect the booster cable for a card in PCI slot 2 to the upper connector.

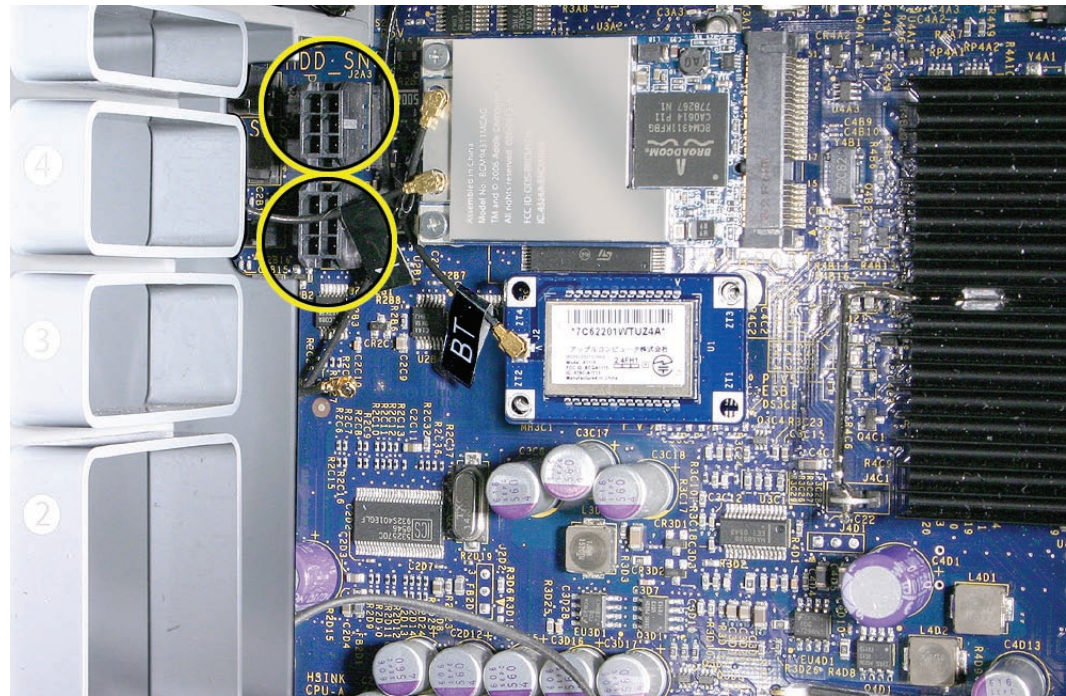



Power Supply

Tools

The only tools required for this procedure are a magnetized 2.5 mm hex wrench and a long-handled, magnetized Phillips #1 screwdriver.

Preliminary Steps

Before you begin, open the computer, lay it on its side with the access side facing up, and remove the following:

- [Hard drives and hard drive carriers in drive bays 3 and 4](#)
- [Optical drive carrier and optical drives](#)
- [Any PCI Express cards that block access to the power supply mounting screws](#)

Part Location

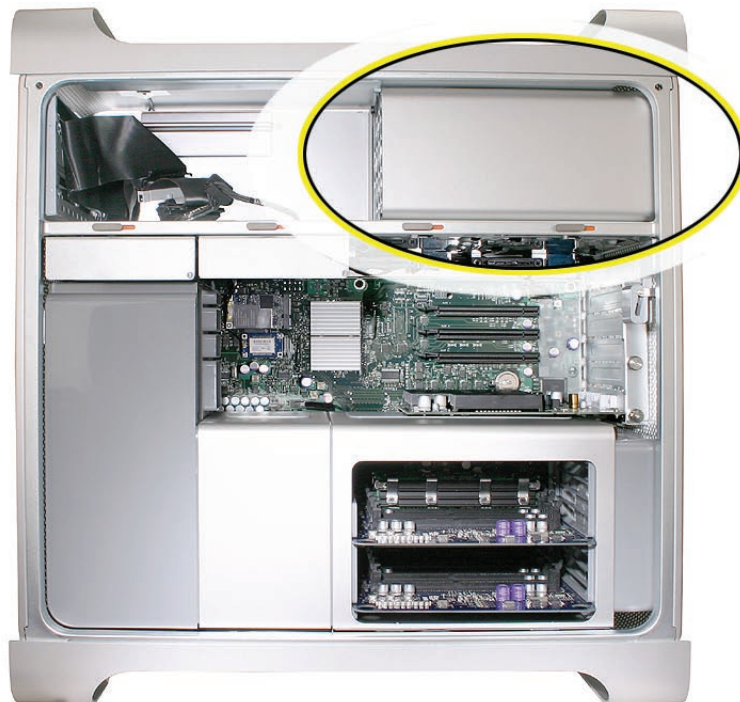

Procedure

1. Using a Phillips screwdriver, remove the two mounting screws on the power supply cable cover located at the back of the optical drive bay.



2. Slide the cover toward the top of the enclosure, tilt it up until the two tabs on the cover clear the slots in the media shelf, and remove the cover from the enclosure.



Replacement Note: Replace the cover at an angle so that the tabs engage with the slots in the media shelf. Then lower the cover into place.

- Using a short-handled, magnetized 2.5 mm hex wrench, remove the four power supply mounting screws from the bottom of the media shelf.

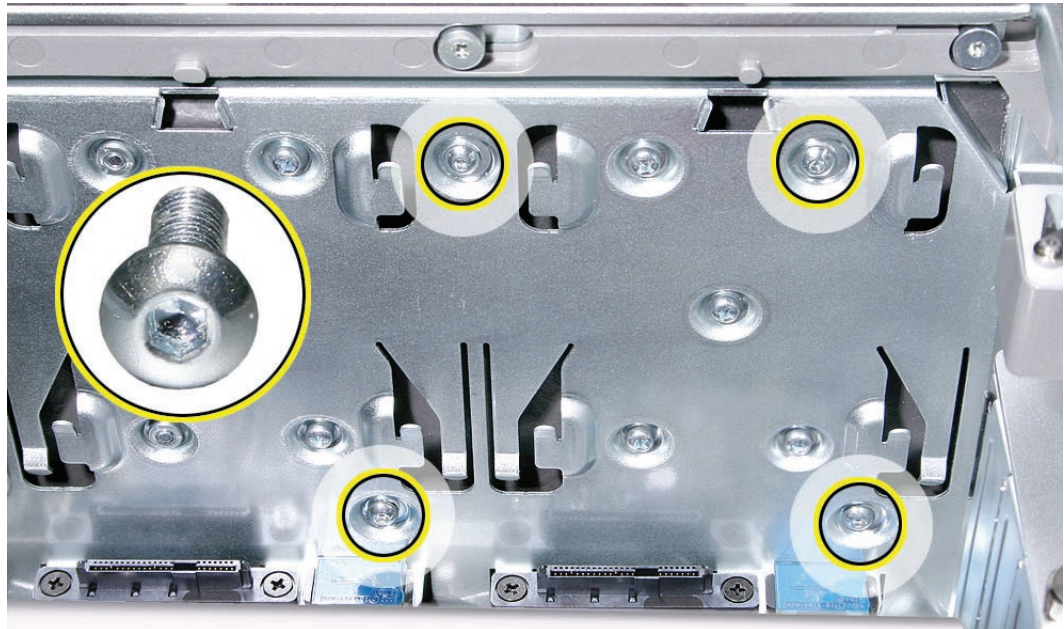

- Release the four power supply cables from their hook-and-loop fasteners on the enclosure.
- Depress the locking latch on each cable connector and disconnect the four power supply cables from the four connectors on the power harness cable.

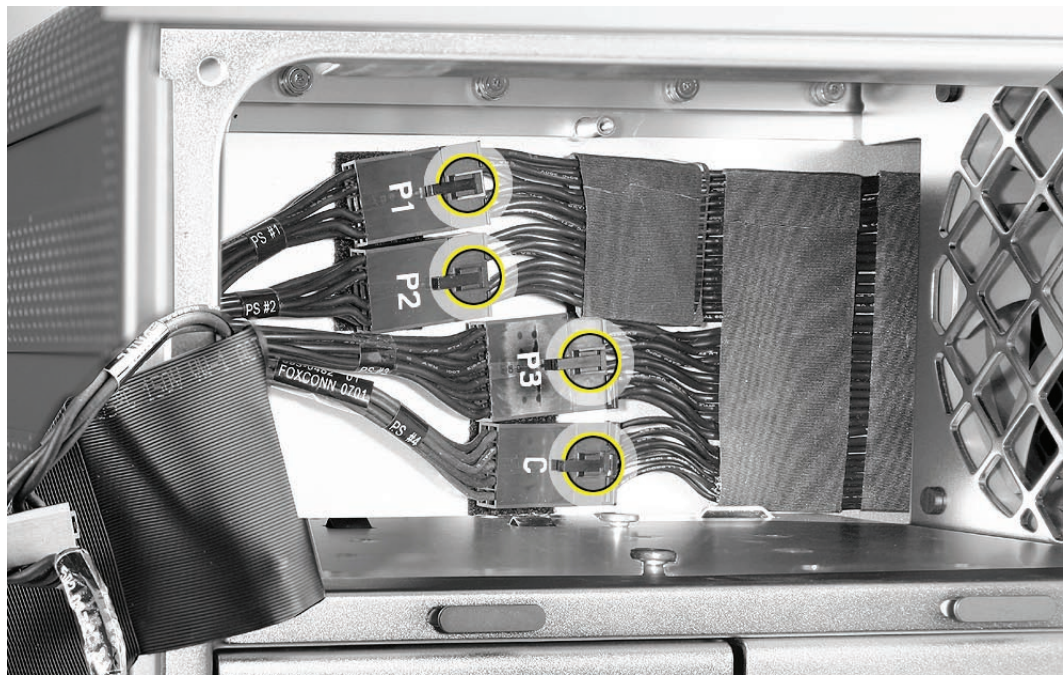

-
6. Slide the power supply toward the front of the computer.

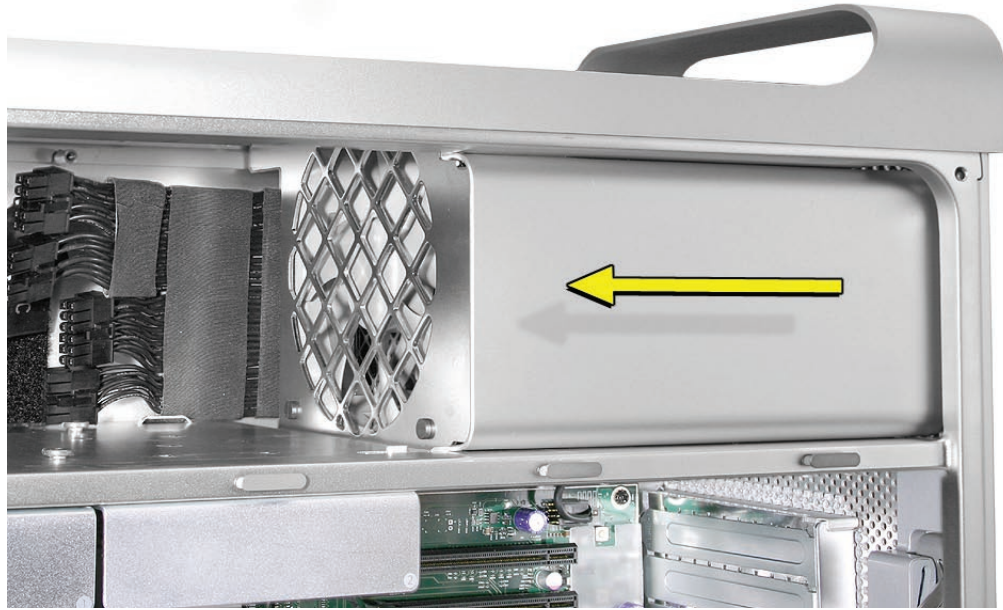

7. Lift the power supply and cables out of the enclosure.

Replacement Note: When replacing the power supply, be sure to slide it toward the back of the computer as far as possible. The power receptacle must align with the opening in the enclosure's back panel and the four screw holes in the power supply must align with the screw holes in the media shelf.



Power Supply Fan

Tools

The only tools required for this procedure are needlenose pliers and scissors or wire cutters (optional)

Preliminary Steps

Before you begin, open the computer, lay it on its side with the access side facing up, and remove the following:

- [Hard drives and hard drive carriers in drive bays 3 and 4](#)
- [Optical drive carrier and optical drives](#)
- [Any PCI Express cards that block access to the power supply mounting screws](#)
- [Power supply](#)

Part Location



Procedure

1. Disconnect the power supply fan cable from the logic board and thread the cable through the opening in the media shelf.

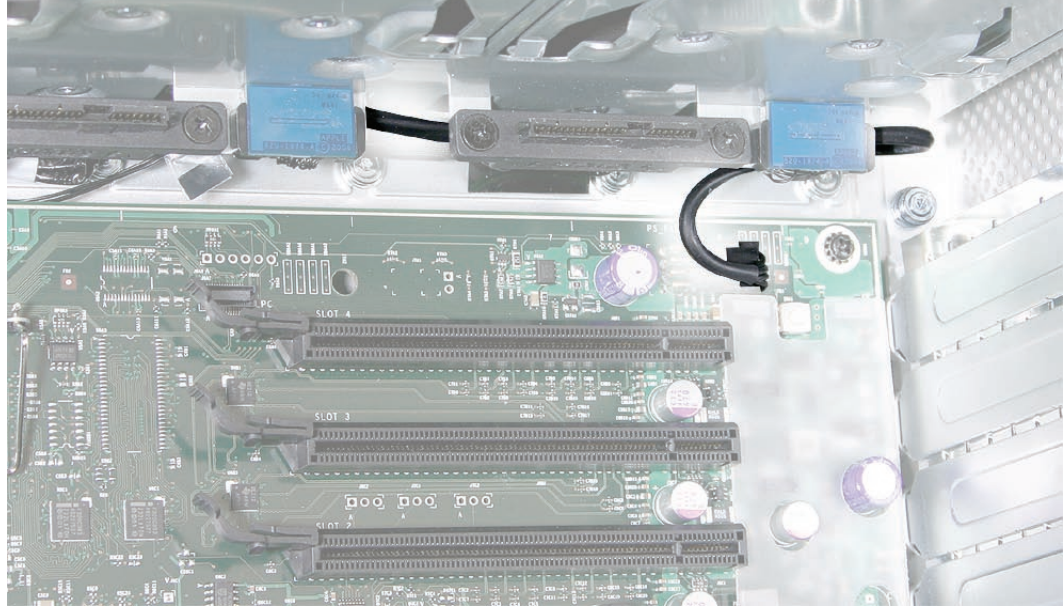

2. Using needlenose pliers, pull out the four grommets that mount the power supply fan to the media shelf divider.

Note: You may find scissors or wire cutters useful in snipping off the grommet heads.



3. Rotate the fan and remove it from the enclosure.

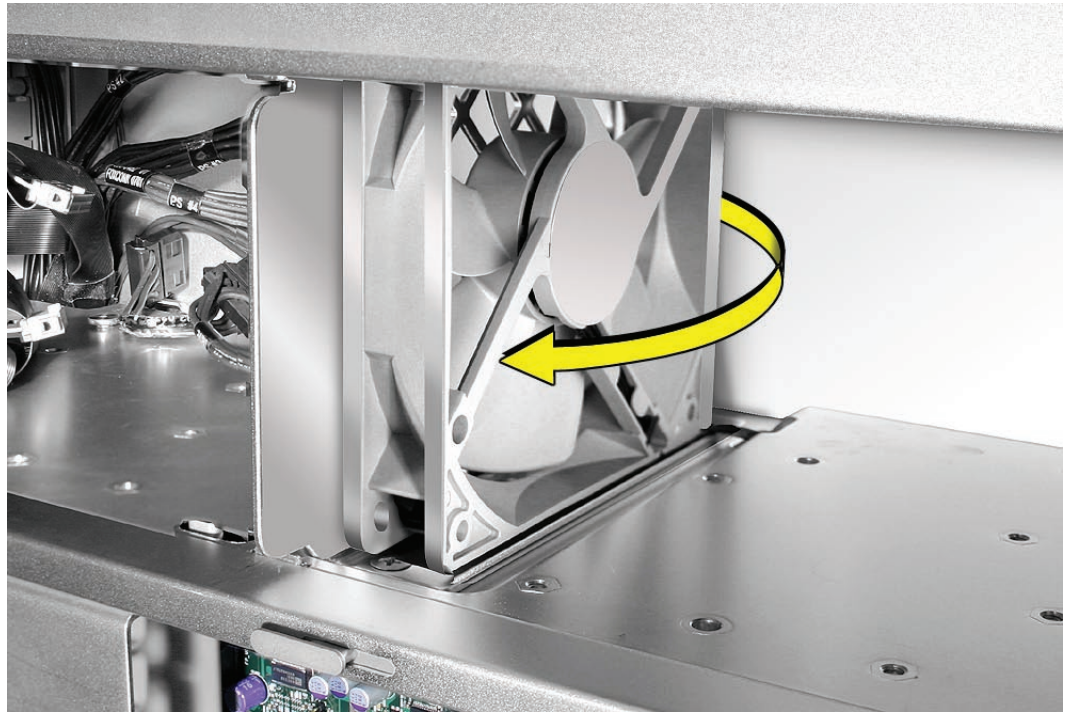

Replacing the Power Supply Fan

1. Place the power supply fan in the media shelf and thread the fan's cable through the opening in the shelf.
2. Connect the cable to the logic board.
3. Rotate the fan into place flush against the media shelf divider. Make sure the back of the fan faces the divider, as illustrated.

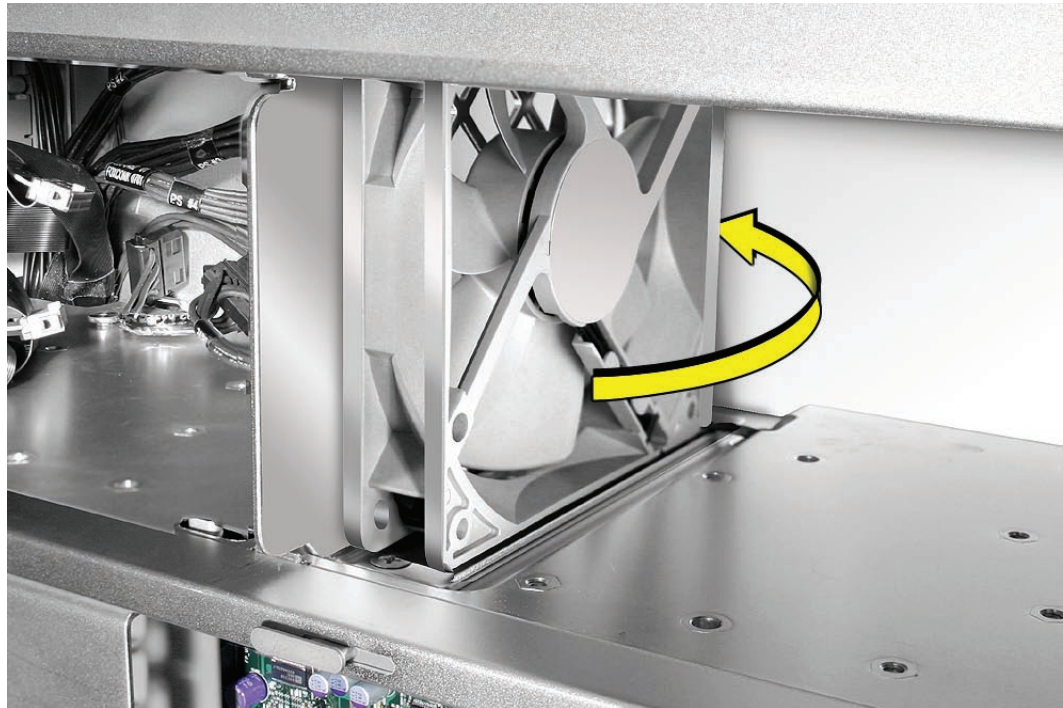

Note: To secure the power supply fan to the divider, use the long-tailed grommets enclosed with the replacement fan.

4. Thread the first grommet, tail first, through one of the four grommet holes in the divider and on through the corresponding grommet hole in the fan bracket. Then pull to secure the grommet and detach the excess threading tail. (The tail is notched to break off at the correct place.)
5. Repeat for the other three grommets.





AirPort Extreme Card

Important: The computer enclosure includes AirPort antenna wires and a Bluetooth antenna wire. The Bluetooth antenna wire looks similar to the AirPort antenna wires, except that it includes a “BT” label. For proper operation, be careful not to connect the Bluetooth antenna wire to the AirPort card or any AirPort antenna wire to the Bluetooth card.

Note: You may connect the AirPort antenna wires to either AirPort card connector.

Tools

The only tool required for this procedure is a magnetized jewelers Phillips #1 screwdriver.

Preliminary Steps

Before you begin, open the computer, and lay it on its side with the access side facing up.

Part Location

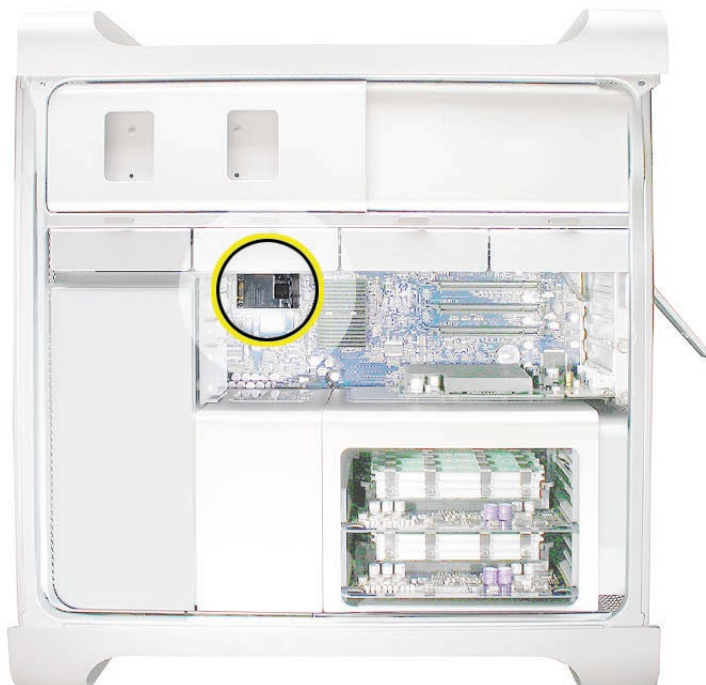

Procedure

1. Remove the two AirPort Extreme card mounting screws.

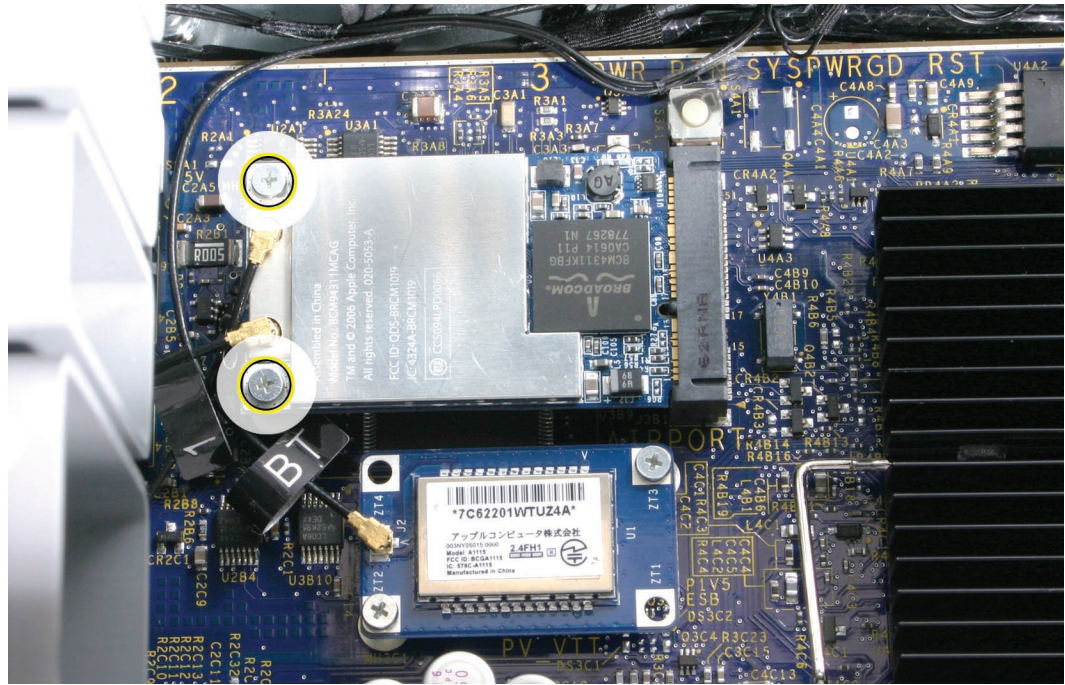

2. Lift the AirPort Extreme card a short distance from the logic board.
3. Disconnect the AirPort antenna wires from the card.



4. Remove the card from the enclosure.

Replacement Note: To replace the AirPort Extreme card, do the following:

- Connect the antenna wires to the card.
Important: Be sure to connect the wires that are marked 1 and 3 to the card; the antenna wire that is marked 2 should be taped out of the way.
- Insert the card into its logic board connector at an angle, as illustrated.
- Lower the screw end of the card down to the standoffs on the logic board and replace the two mounting screws.

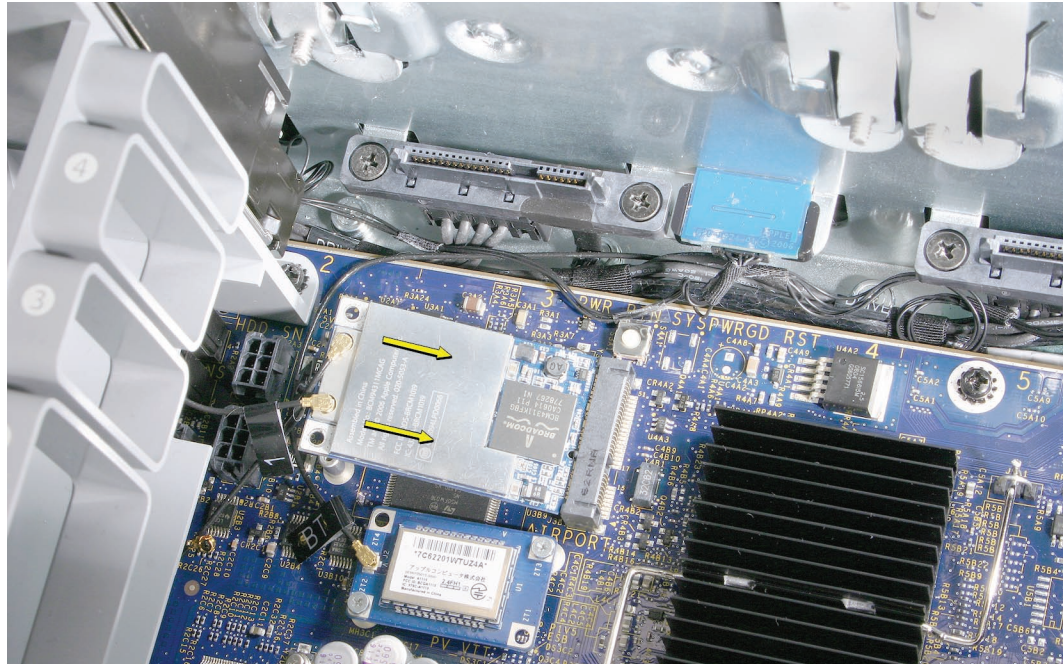

Note: If you are not replacing the AirPort card, cover the connectors on the AirPort antenna wires with Kapton or other non-conductive tape to prevent them from shorting out components on the logic board.



Bluetooth Card

Important: The computer enclosure includes one Bluetooth antenna wire, which looks similar to the AirPort antenna wires, except that it includes a “BT” label. If the label is missing, you can also identify the Bluetooth cable by its location; it is the cable that runs to the back of the computer. For proper operation, be careful not to connect the Bluetooth antenna wire to the AirPort card or any AirPort antenna wire to the Bluetooth card.

Tools

The only tool required for this procedure is a magnetized jewelers Phillips #1 screwdriver.

Preliminary Steps

Before you begin, open the computer, and lay it on its side with the access side facing up.

Part Location

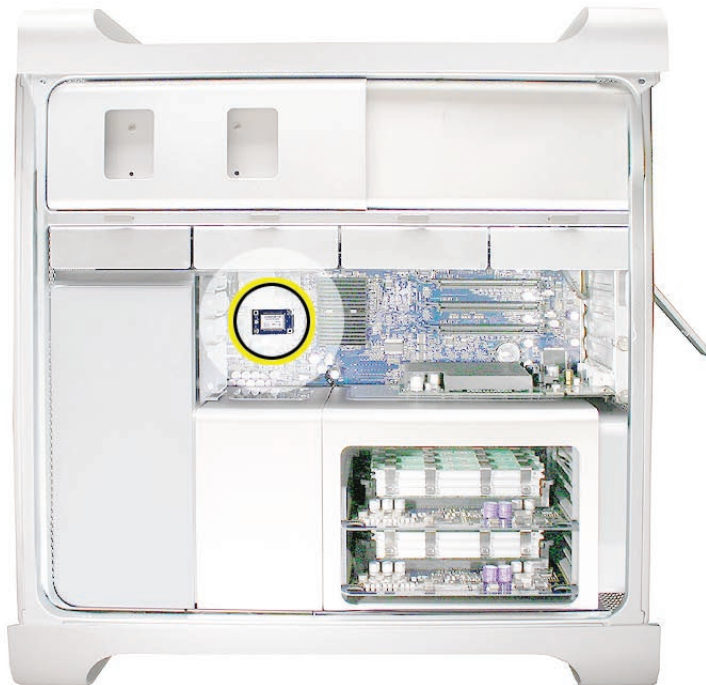

Procedure

1. Remove the two Bluetooth card mounting screws.

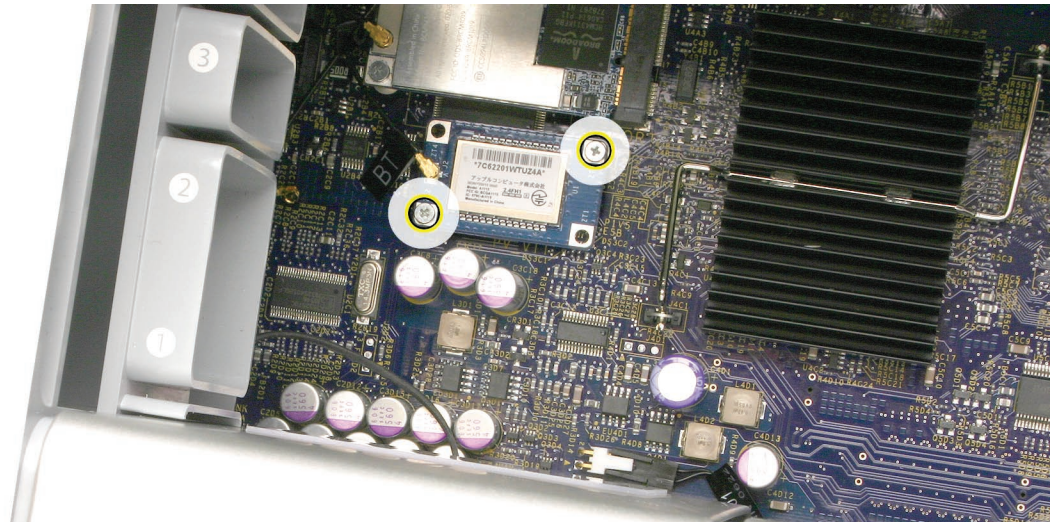

2. Lift the Bluetooth card a short distance from the logic board.
3. Disconnect the Bluetooth antenna wire from the card.
4. Remove the card from the enclosure.

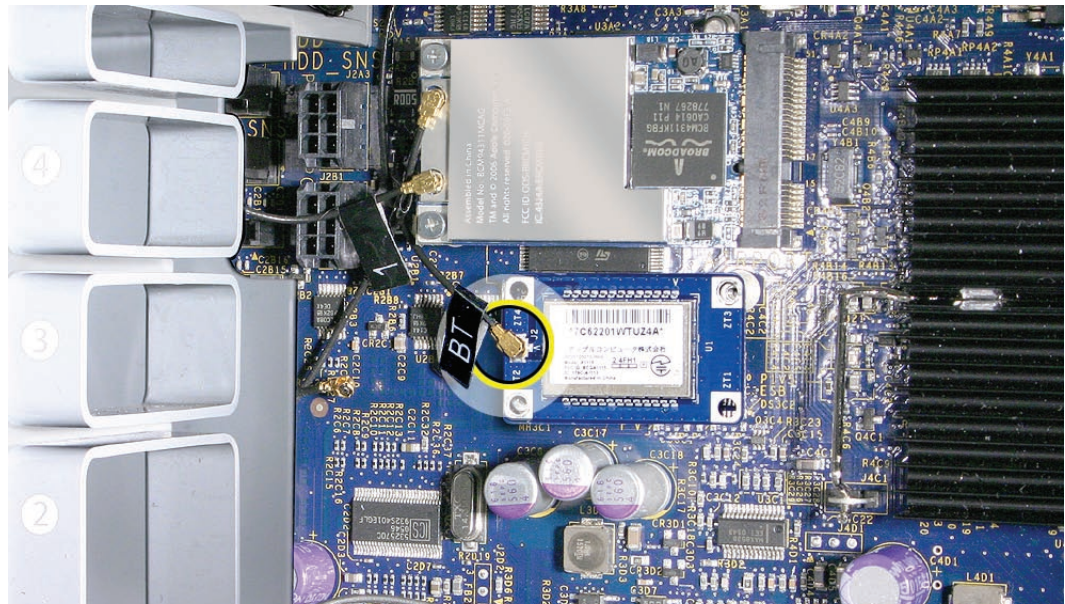

Note: If you are not replacing the Bluetooth card, cover the connector on the Bluetooth antenna wire with Kapton or other non-conductive tape to prevent it from shorting out components on the logic board.



Battery

Tools

No tools are required for this procedure. You may, however, find a flat-blade screwdriver useful in removing the battery from its holder.

Preliminary Steps

Before you begin, open the computer, lay it on its side with the access side facing up, and remove any [PCI Express cards](#) that block access to the battery.

Part Location



Procedure

1. Slide the battery out from underneath the battery holder's metal clip.
2. Remove the battery from its holder.

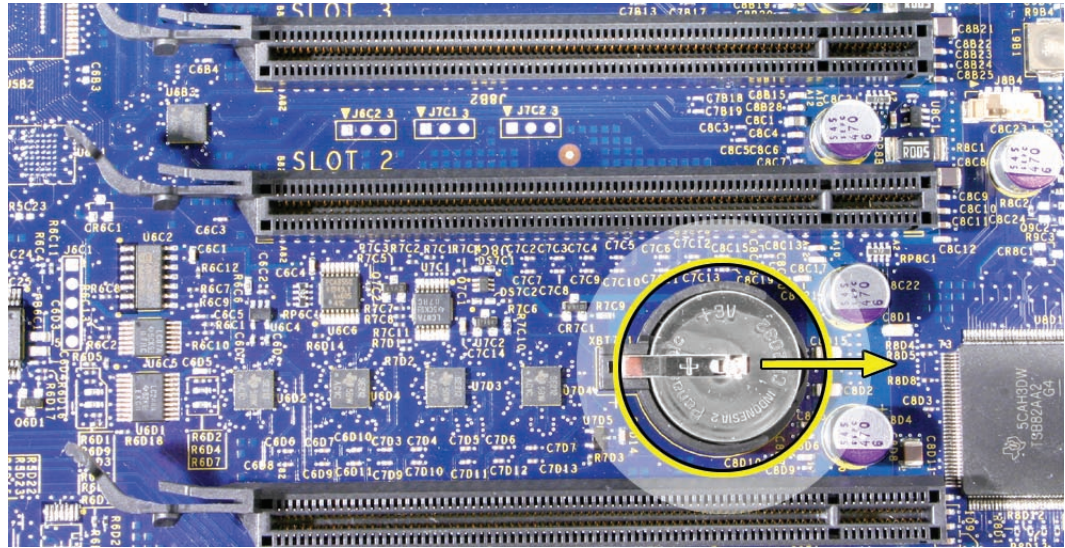

Replacement Note: Insert the new battery into the holder, making sure the battery's positive symbol (+) faces up.

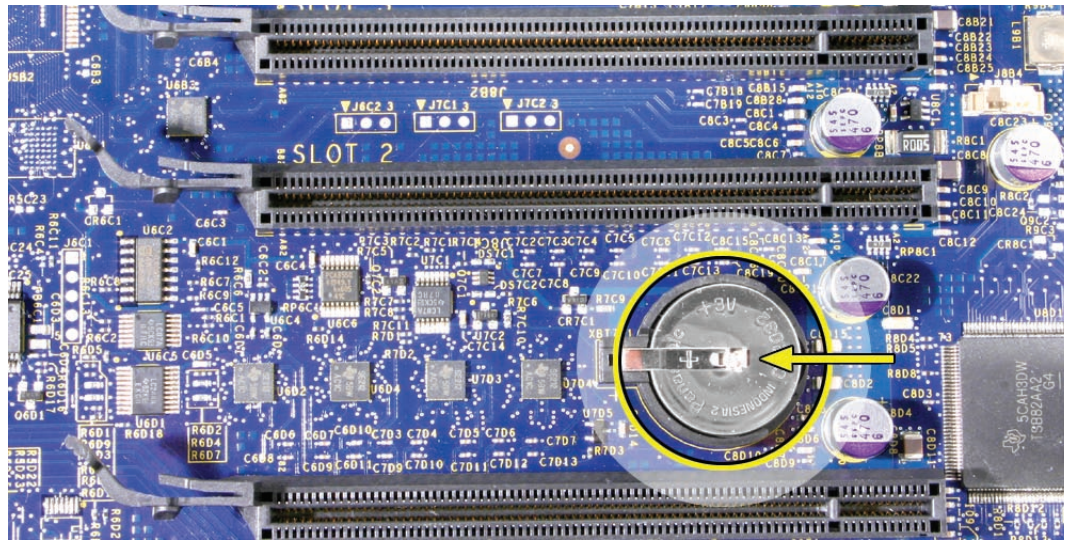

Warning: Installing the battery incorrectly may cause an explosion. Be sure the battery's positive and negative sides are correctly oriented in the holder. Use only the same type of battery or an equivalent recommended by the manufacturer of the original.

Important: Batteries contain chemicals, some of which may be harmful to the environment. Please dispose of used batteries according to your local environmental laws and guidelines.



Processor Heatsink Cover

Tools

No tools are required for this procedure.

Preliminary Steps

Before you begin, open the computer, lay it on its side with the access side facing up, and remove any [12-inch PCI Express cards](#).

Part Location



Procedure

Note: The heatsink cover is held in place by a number of tabs and magnets on the underside of the cover. You must release the tabs before you can remove the cover from the enclosure.

1. Place the fingers of one hand under the lip of the heatsink cover nearest the logic board. Lift the lip slightly toward the media shelf to release the tabs and magnets under the top face of the cover.
2. With your fingers still under the cover's bottom lip, lift the cover straight up to release the remaining tabs and magnets under the front face of the cover.
3. Remove the cover from the enclosure.

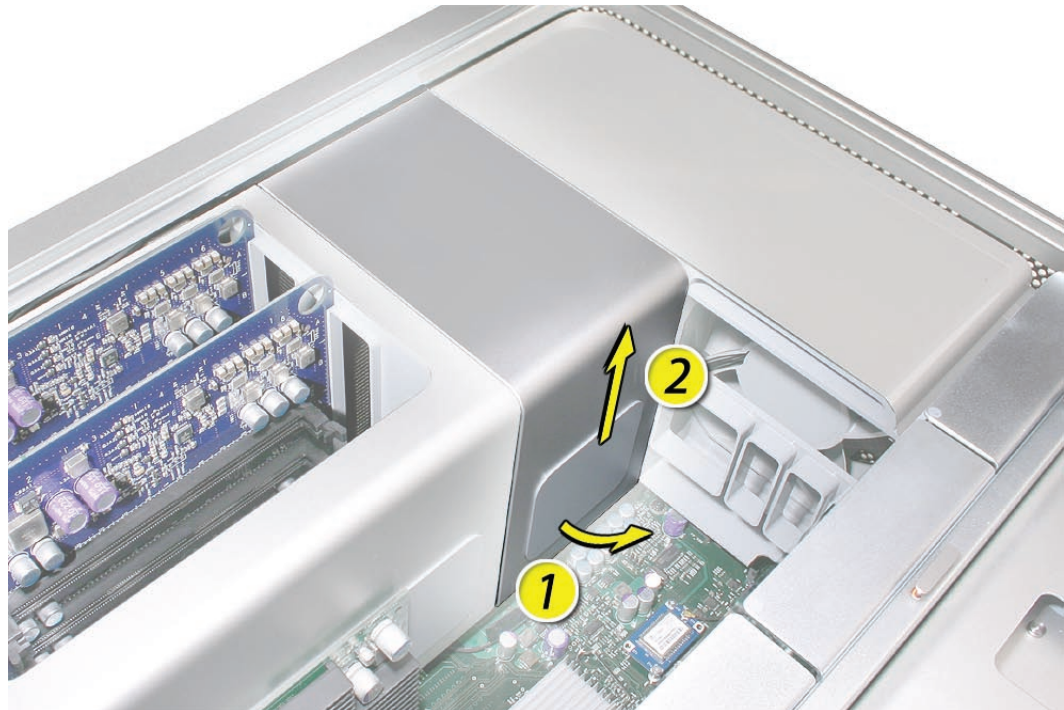

Replacement Note: When reinstalling the processor heatsink cover, make sure the tabs on the underside of the cover align with the slots directly below them. (The slots are on the front fan and memory cage on either side of the heatsink cover.)

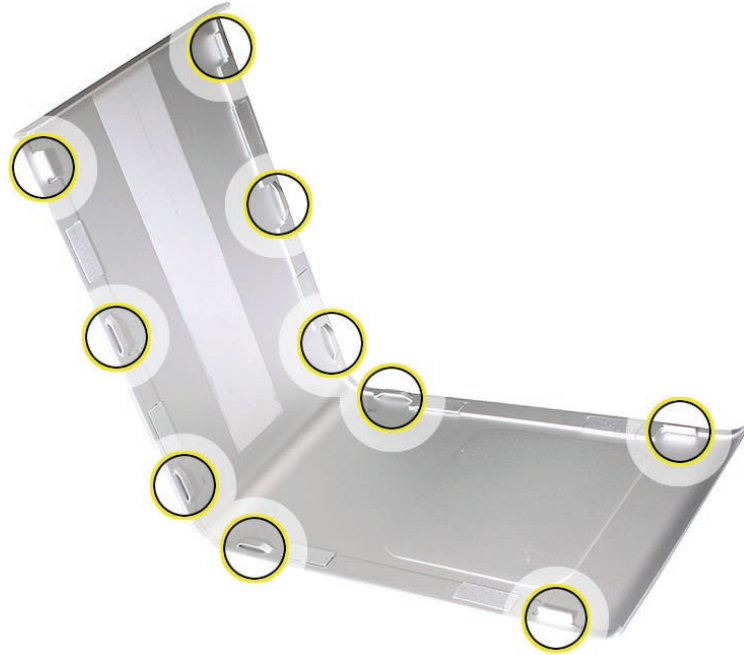



Front Fan Assembly

Tools

The only tool required for this procedure is a long-handled, magnetized #1 Phillips screwdriver.

Preliminary Steps

Before you begin, open the computer, lay it on its side with the access side facing up, and remove the following:

- [Hard drives and hard drive carriers in drive bays 1 and 2](#)
- [Any 12-inch PCI Express cards](#)
- [Processor heatsink cover](#)

Part Location



Procedure

1. Using a long-handled, magnetized #1 Phillips screwdriver, remove the screw at the top rear of the front fan assembly that mounts the assembly to the logic board.

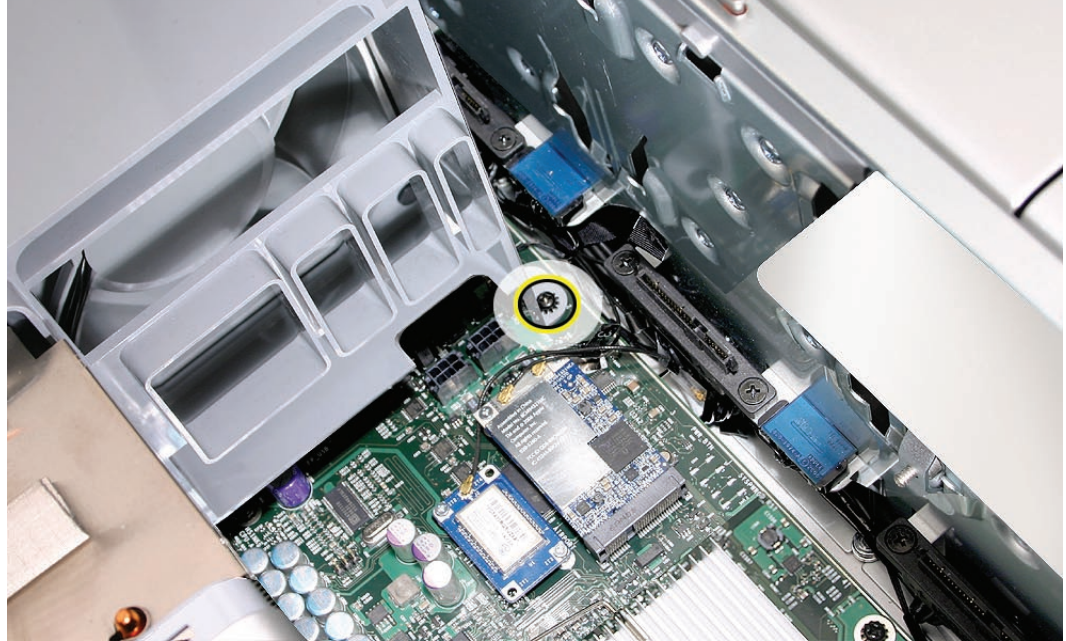

2. Remove the second Phillips screw at the bottom front of the assembly.

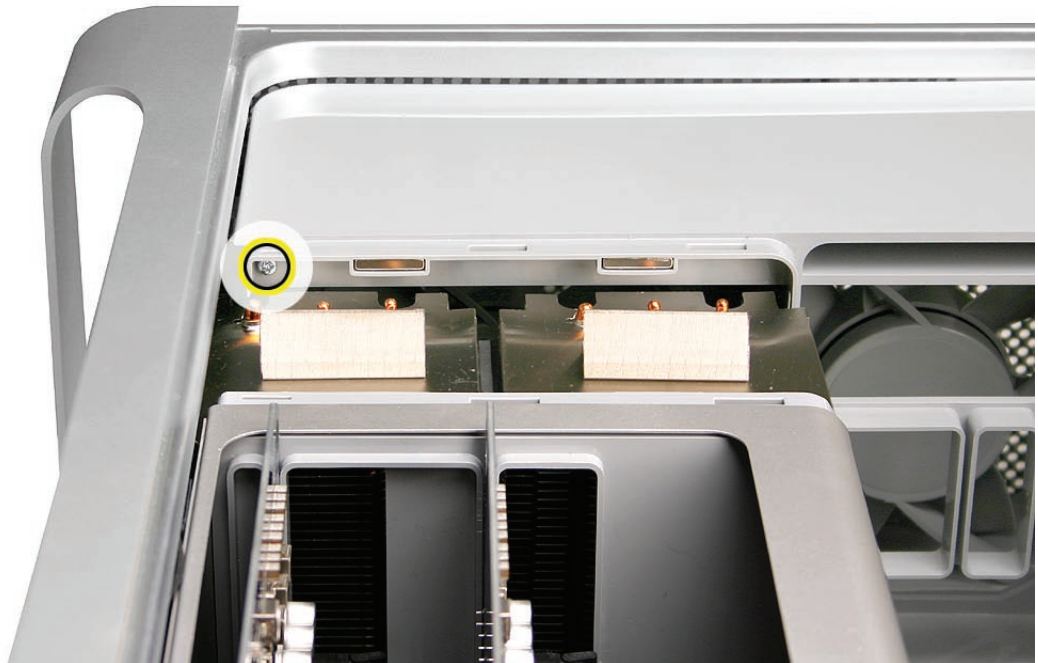

3. Place one hand on each end of the fan, lift straight up, and remove the fan from the enclosure.

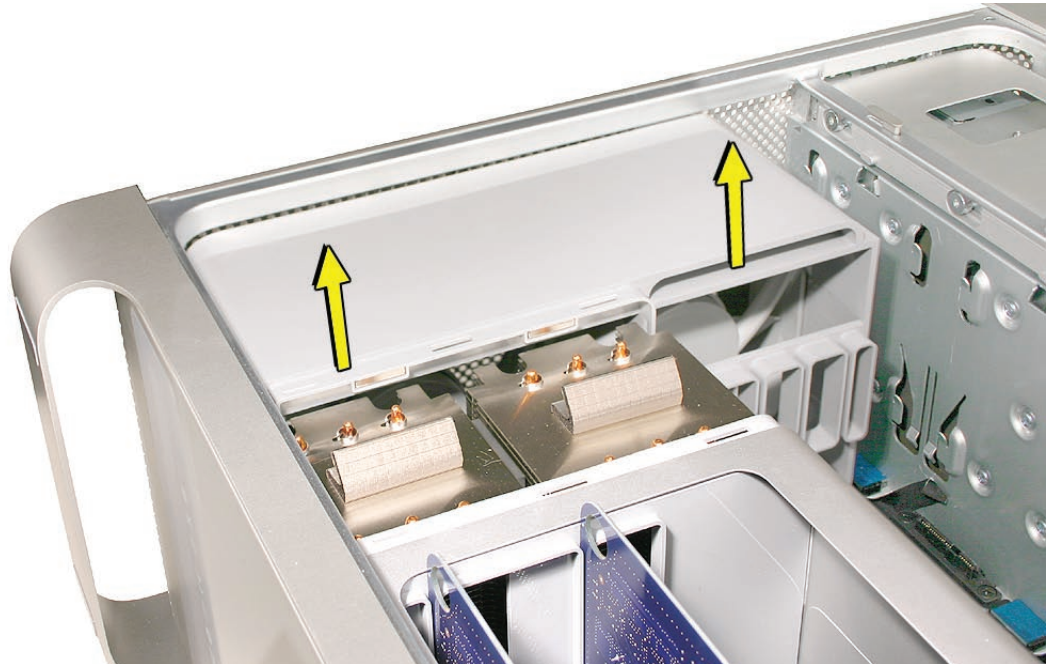

Replacement Note: Before re-installing the front fan assembly in the enclosure, make sure that the fan cables are routed correctly in the fan channel.

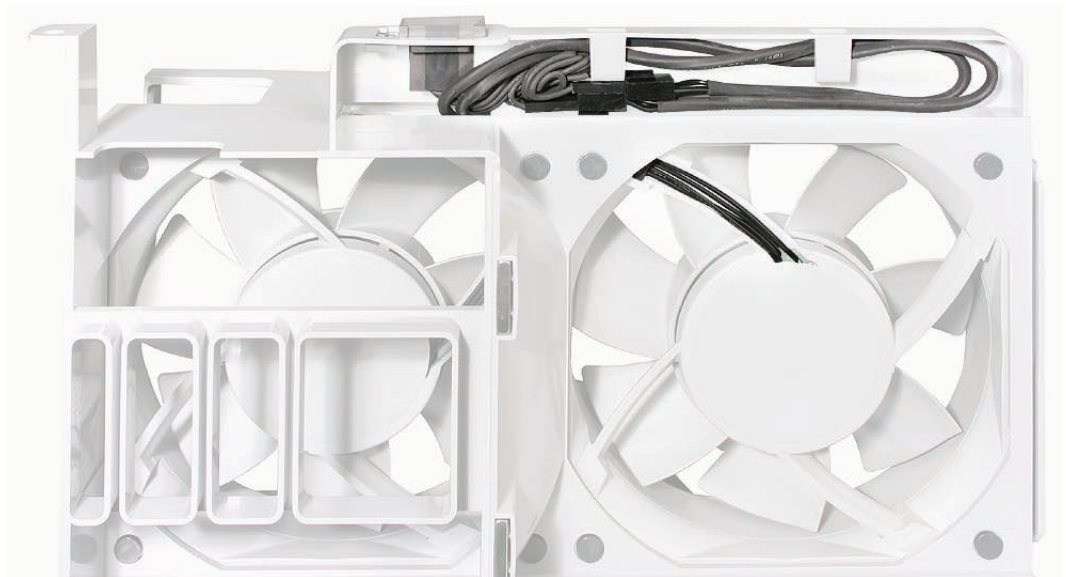

Replacement Note: Make sure all AirPort and Bluetooth antenna wires are out of the way before lowering the fan assembly onto the logic board.

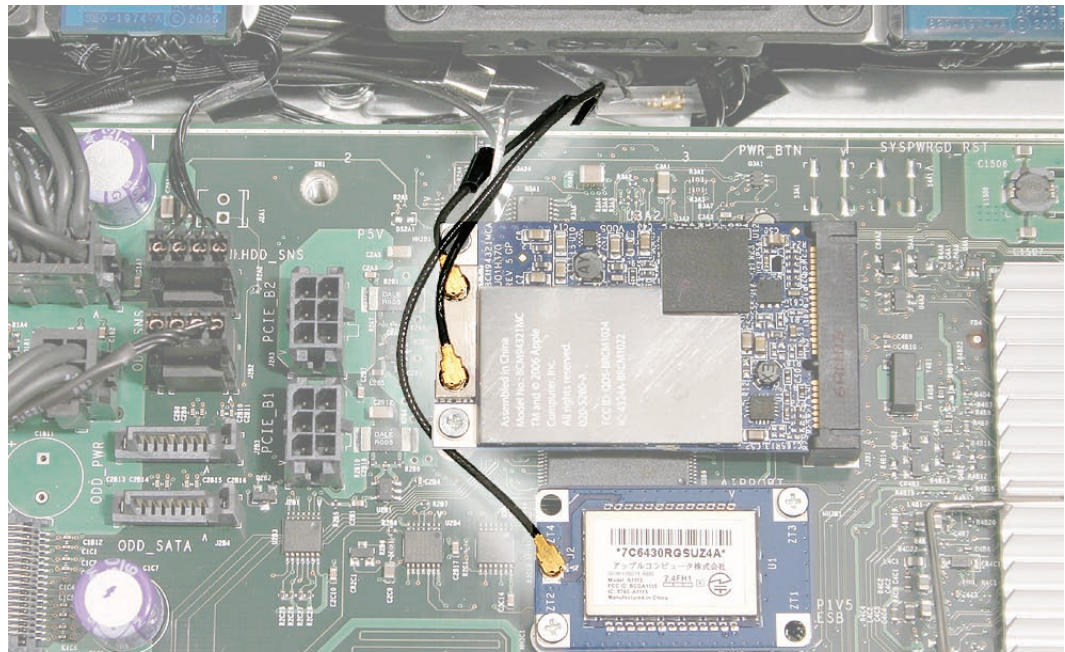

Replacement Note: When lowering the front fan into the enclosure, slide the guide on the base of the fan assembly into the channel on the speaker assembly.



Also make sure the latch on the inside top left edge of the fan assembly engages with the slot on the inside lip of the enclosure. Then press down until you hear the fan click into place in the connector on the logic board.





Mac Pro RAID Card and Battery

Note: If a Mac Pro RAID Card is installed in a Mac Pro (8x), the standard iPass cable routing has been changed so that the cable connects to the card, rather than to the logic board.

Tools

The only tool required for this procedure is a Phillips #1 screwdriver. You might also find a small flat-blade screwdriver helpful in releasing the iPass cable connector.

Preliminary Steps

Before you begin, open the computer, lay it on its side with the access side facing up, and remove the following:

- [All hard drives and hard drive carriers](#)
- [Any 12-inch PCI Express cards](#)
- [Processor heatsink cover](#)
- [Front fan assembly](#)

Part Location



Procedure

1. If you have not already done so, loosen the two captive screws that secure the PCI bracket to the enclosure and remove the bracket.

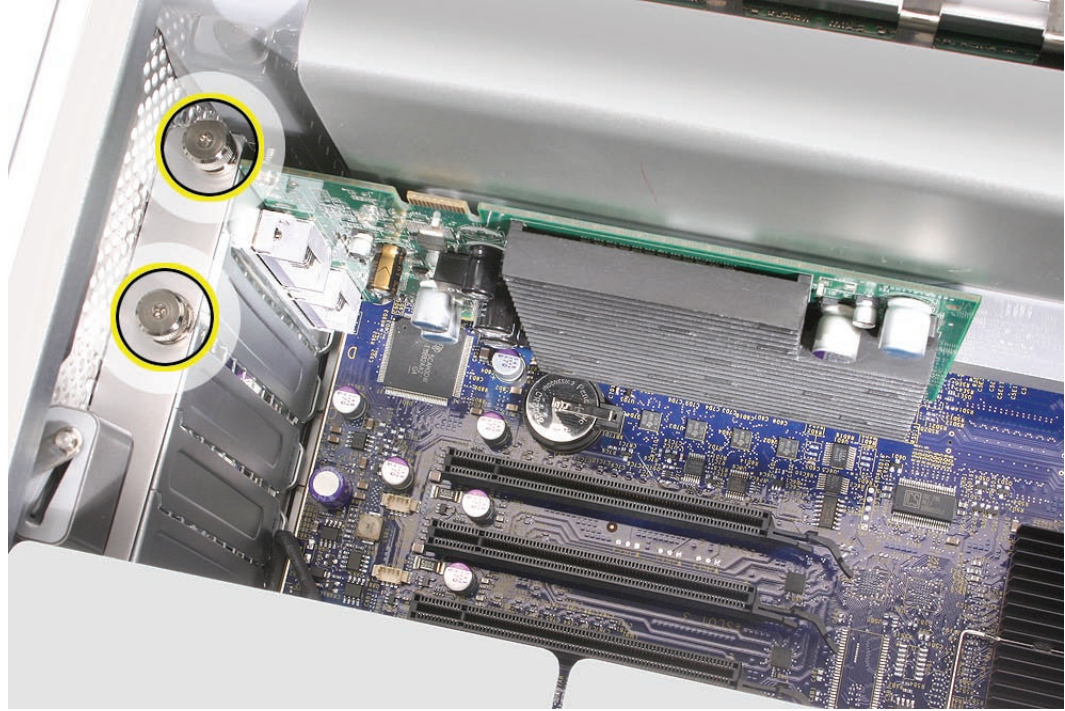

Warning: When removing or installing a card, handle it only by the edges. Do not touch its connectors or any of the components on the card. Lift the card straight out from the connector to remove it, and insert it straight into the connector to install it. Do not rock the card from side to side and don't force the card into the slot. Once the replacement card is installed, pull on it gently to check that it is properly connected.

2. Release the small locking clip at the front of the card's logic board connector by pushing the clip up toward the media shelf.
3. Holding the card by the top corners, gently pull up the card and remove it from its expansion slot.

Note: The Mac Pro RAID Card must always be installed in slot 4.

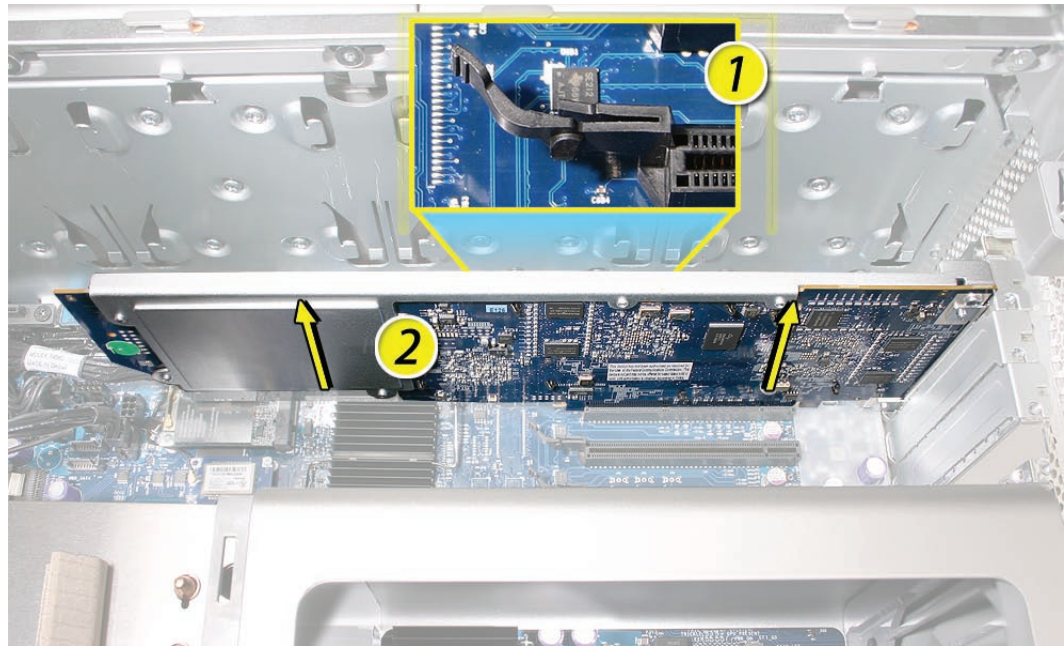

4. Disconnect iPass cable from the Mac Pro RAID Card.

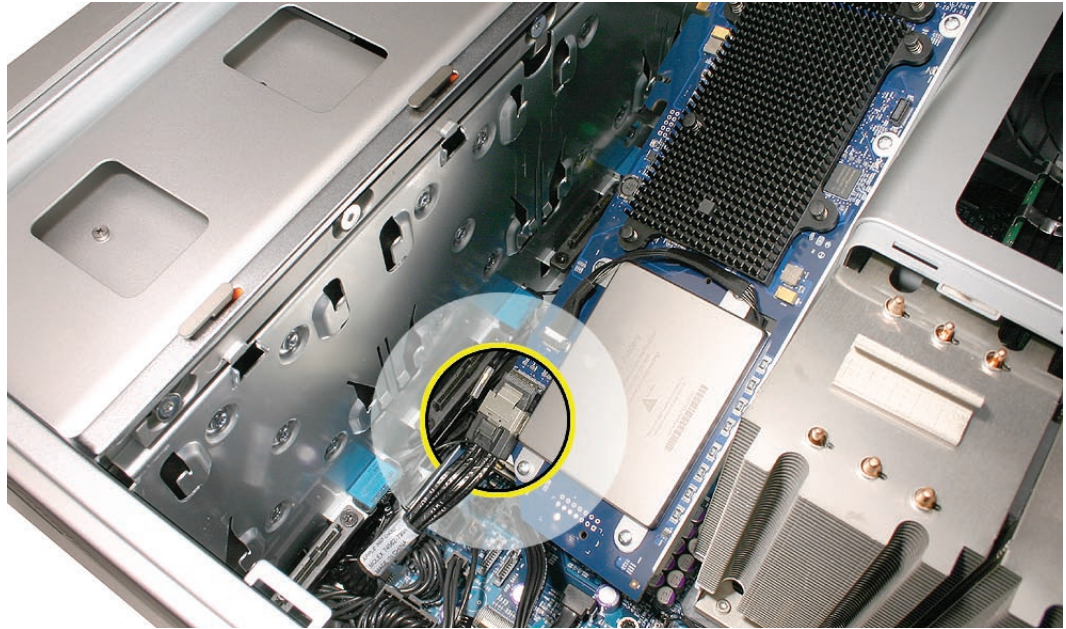

Note: You may find it helpful to use a small, flat-blade screwdriver to release the cable connector. Depress the rear edge of the silver-colored latch on top of the connector.

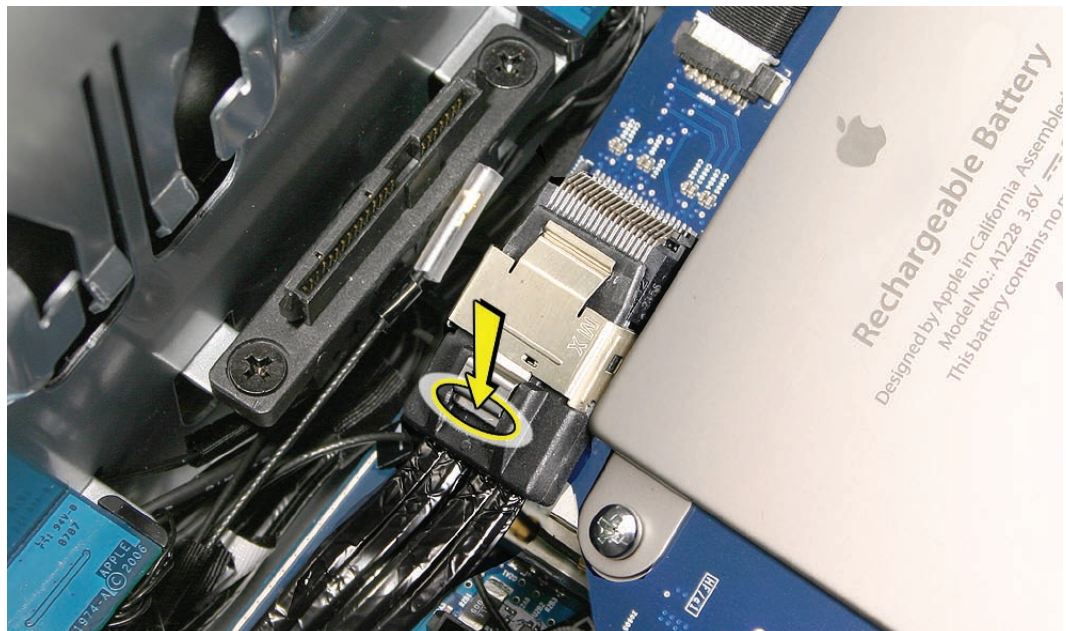

5. Remove the card from the enclosure.

Replacing the Mac Pro RAID Card

1. Connect the iPass cable to the Mac Pro RAID Card.
2. Align the card's connector with expansion slot 4 and press until the connector is inserted all the way into the slot. Make sure the card also engages slot 4 in the PCI card guide.

Note:

- Don't rock the card from side to side; instead, press the card straight into the slot.
- Don't force the card. If you meet a lot of resistance, pull the card out. Check the connector and the slot for damage or obstructions, then try inserting the card again.
- Pull the card gently to see if it is properly connected. If it resists and stays in place and its gold connectors are barely visible, the card is connected.

Note: System Profiler does not display the serial number for the Mac Pro RAID Card. You can find the serial number by checking the serial number sticker on the back of the card.



Memory Cage with Rear Fan

Tools

The only tools required for this procedure are a long-handled, magnetized #1 Phillips screwdriver and a short-handled, magnetized jeweler's #1 Phillips screwdriver or right-angle, magnetized #1 Phillips screwdriver.

Preliminary Steps

Before you begin, open the computer, lay it on its side with the access side facing up, and remove the following:

- [PCI Express card installed in slot 1](#)
- [Any 12-inch PCI Express cards](#)
- [Processor heatsink cover](#)
- [Top and bottom memory cards](#)

Part Location

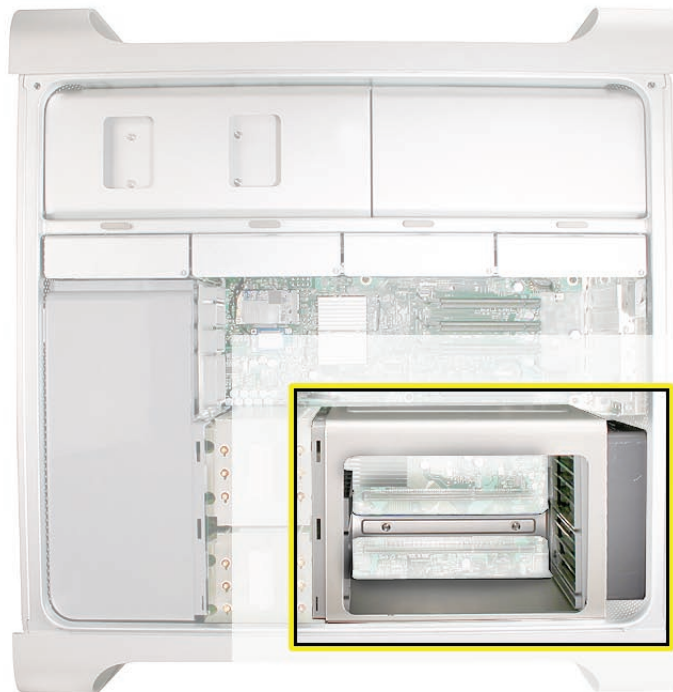

Procedure

1. Disconnect the rear fan cable from the logic board.



2. Using a long-handled, magnetized #1 Phillips screwdriver, remove the two long screws that mount the memory cage to the logic board.
3. Using a short-handled, magnetized jeweler's #1 Phillips screwdriver or right-angle, magnetized #1 Phillips screwdriver, carefully remove the two short screws that mount the memory cage to the bottom panel of the enclosure.



Note: To remove the memory cage and fan, you must first slide the fan partway into the cage. The fan is held in place by two latches, which you must release before sliding the fan.

4. Using your forefinger, reach below the fan and release the latch nearest the logic board.
5. Using a flat-blade screwdriver, release the second latch nearest the front of the computer.



6. Slide the rear fan into the memory cage.

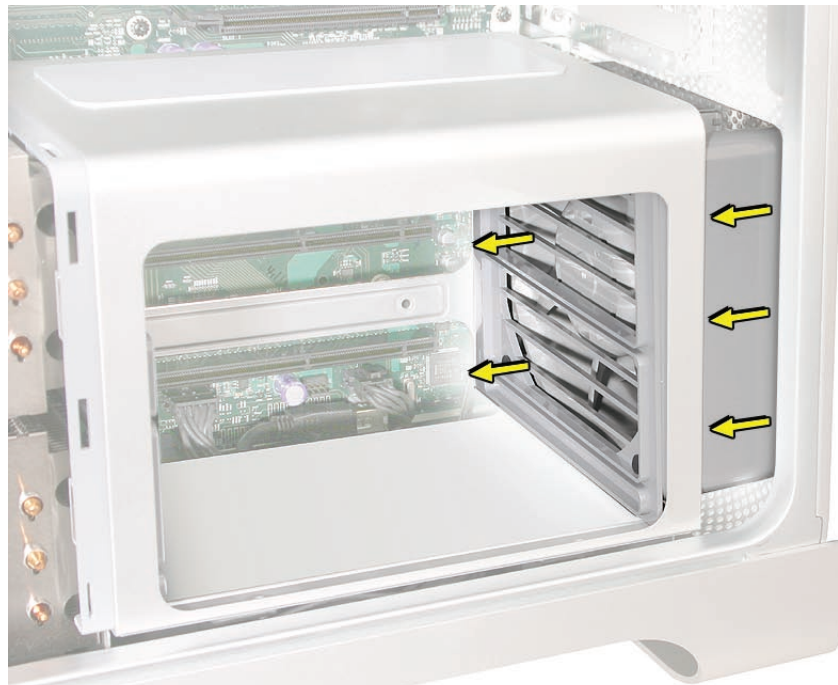

-
7. Slide the memory cage and fan toward the power supply far enough that the cage clears the bottom edge of the enclosure. Then lift the memory cage and fan out of the enclosure.

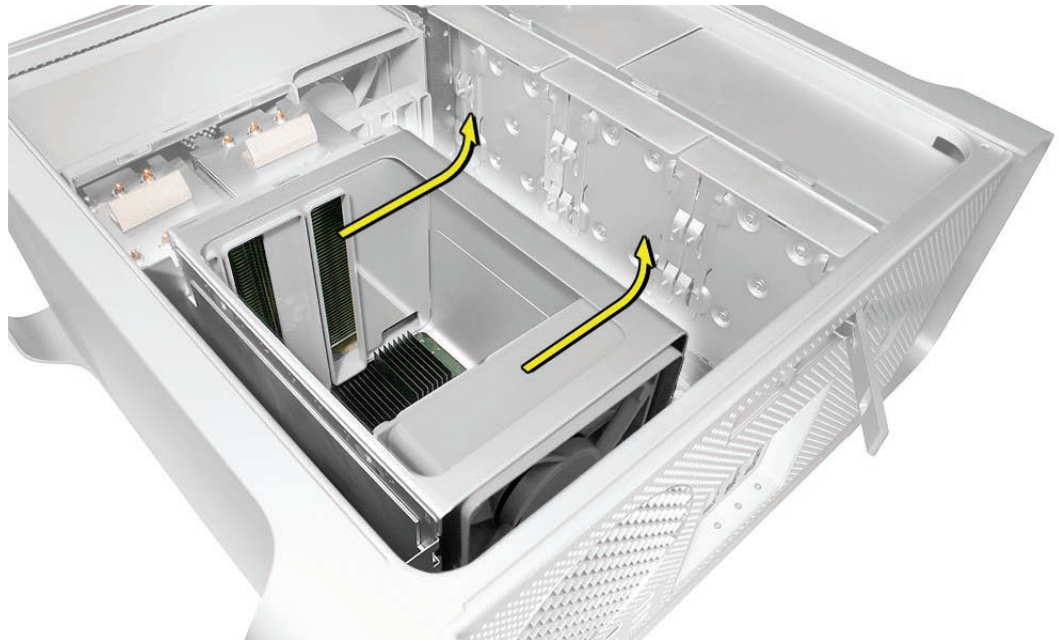

Replacement Note: If you are installing a new fan in the memory cage assembly, position the fan as illustrated.

Important: Before you install the cage in the enclosure, the fan should always be inserted partway into the cage.



Replacement Note: Before installing the memory cage and fan, make sure all logic board cables below the cage are out of the way so that the cage sits properly and the cables are not pinched or damaged when you tighten the screws.

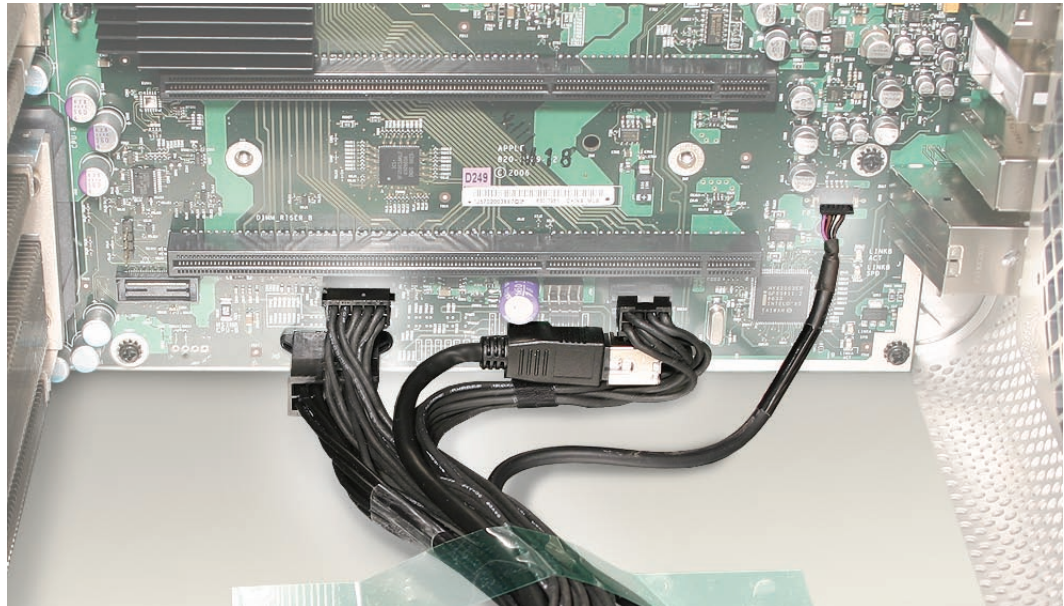

Replacement Note: To install the memory cage and fan, maneuver the cage into position in the enclosure. Replace one long mounting screw. Then slide the fan toward the back panel, until you hear it snap into place.



Replace the other three mounting screws and reconnect the rear fan cable to the logic board.



Processor Heatsinks

The Mac Pro (8x) computer uses a special coating on the processor heatsink and processor to manage the temperature in the computer. The silver-colored coating comes applied to the underside of the heatsink and the top of the processor.

Use the following guidelines when handling the processor heatsink and/or processor:

- Wear disposable nitrile or latex gloves.
- Avoid touching the silver-colored coating on the underside of the heatsink and the top of the processor.
- Always make a visual inspection of new or existing heatsinks and processors before installing them in the computer. See “[Processor Heatsink and Processor Visual Inspection Instructions](#)” in the Troubleshooting chapter for more information.
- When removing or replacing the heatsink and/or processor, do not allow the heatsink to be separated from the processor for more than 30 minutes. The special coating on the heatsink and processor degrades with exposure to air; more than 30 minutes exposure could result in damage to the computer and a repeat, multi-part repair.

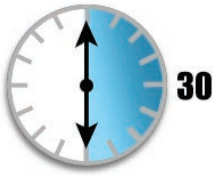

IMPORTANT:

If you need to install a new heatsink or processor, reassemble the unit while you are waiting for the new part to arrive.

Tools

The only tool required for this procedure is a long-handled, magnetized 3 mm flathead hex screwdriver.

Preliminary Steps

Before you begin, open the computer, lay it on its side with the access side facing up, and remove the following:

- [Hard drives and hard drive carriers in drive bays 1 and 2](#)
- [PCI Express card installed in slot 1](#)
- [Any 12-inch PCI Express cards](#)
- [Processor heatsink cover](#)
- [Front fan assembly](#)
- [Top and bottom memory cards with DIMMs](#)
- [Memory cage with rear fan](#)

Part Location



Procedure

1. Disconnect the 2-pin cable for the upper processor (CPU A) heatsink from the logic board.

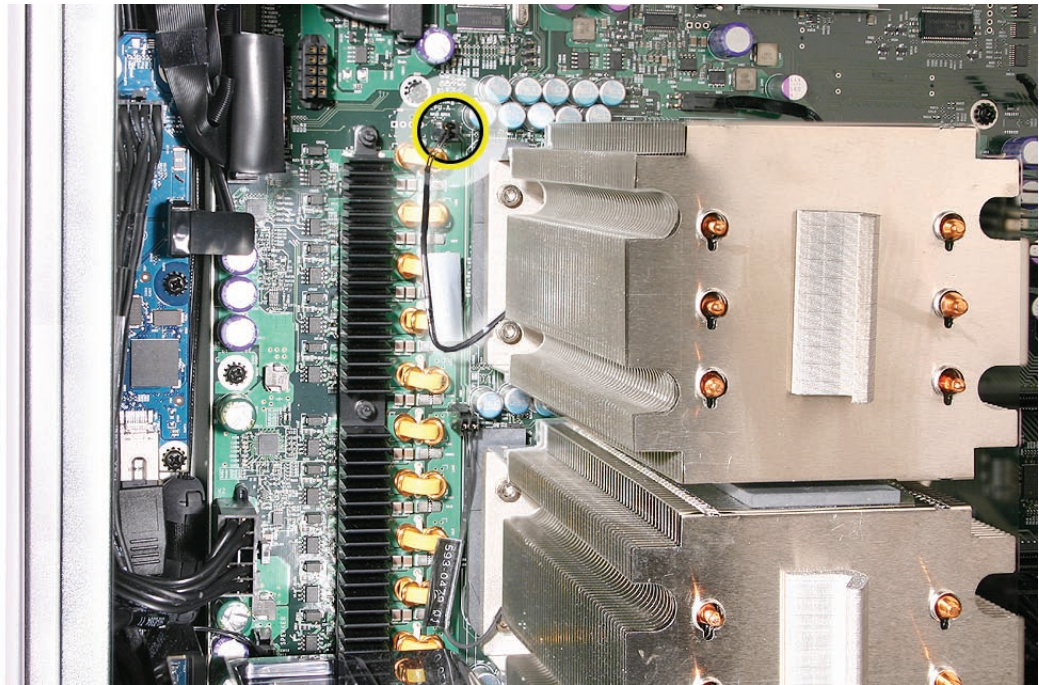

- Using a long-handled, magnetized 3 mm flathead hex screwdriver, loosen the four captive mounting screws for the upper processor heatsink in the order indicated below.

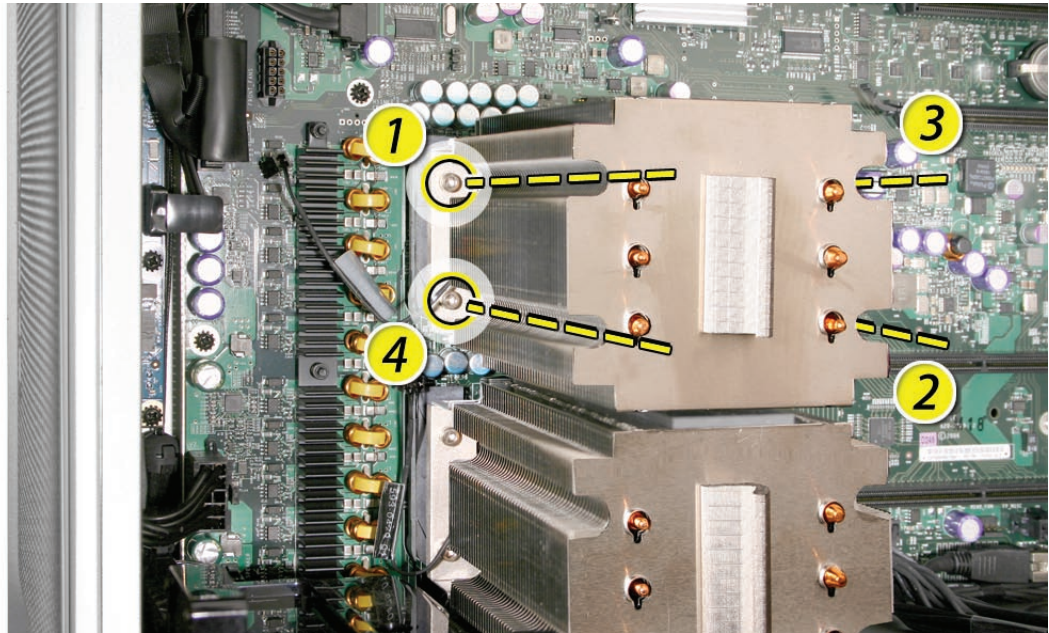

- Lift the heatsink straight up and out of the enclosure.
- Disconnect the cable connector for the lower processor (CPU B) heatsink.

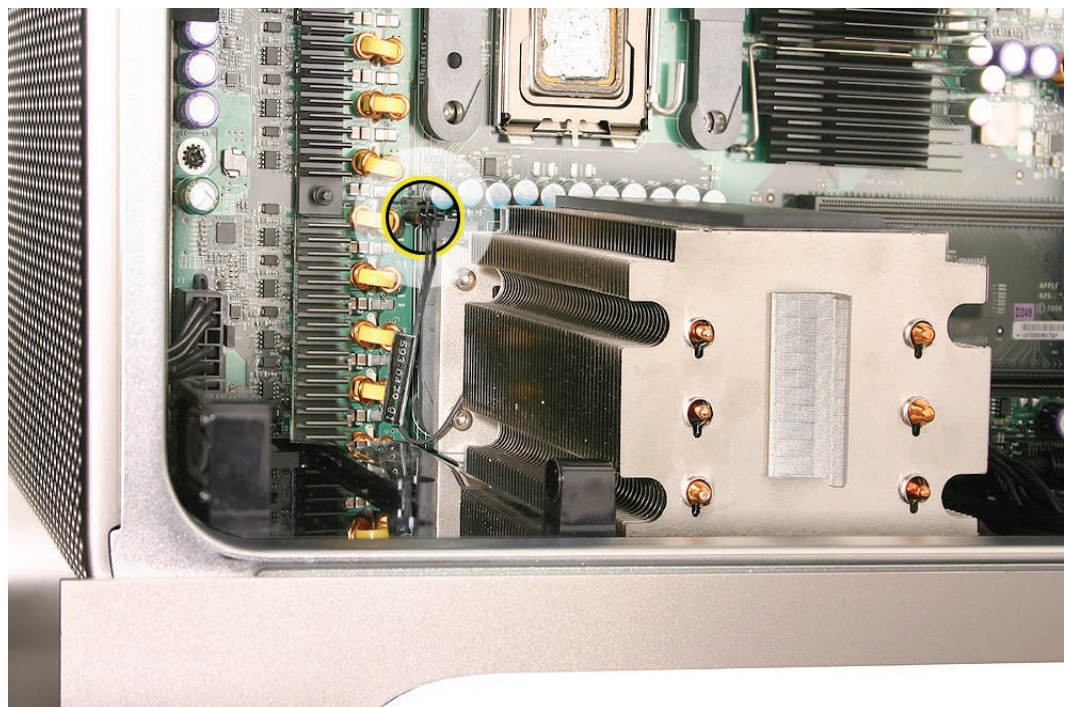

- Using a long-handled, magnetized 3 mm flathead hex screwdriver, loosen the four captive mounting screws for the lower processor heatsink in the order indicated below.

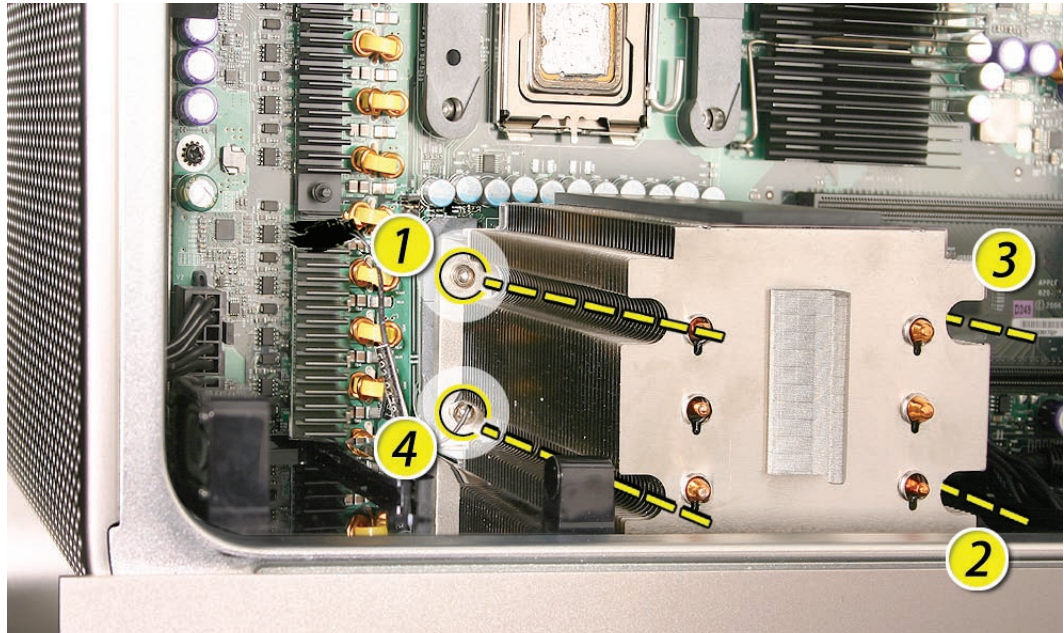

- Carefully tilt the heatsink so that it clears the bottom lip of the enclosure and then lift the heatsink out of the computer.

IMPORTANT:

Remember that you cannot leave the heatsink separated from either the upper or lower processor for more than 30 minutes.



Visual Inspection of Heatsink Gasket

Before installing a new or existing heatsink, check that the gasket that surrounds the silver-colored coating on the underside of the heatsink is in good condition, as illustrated below.

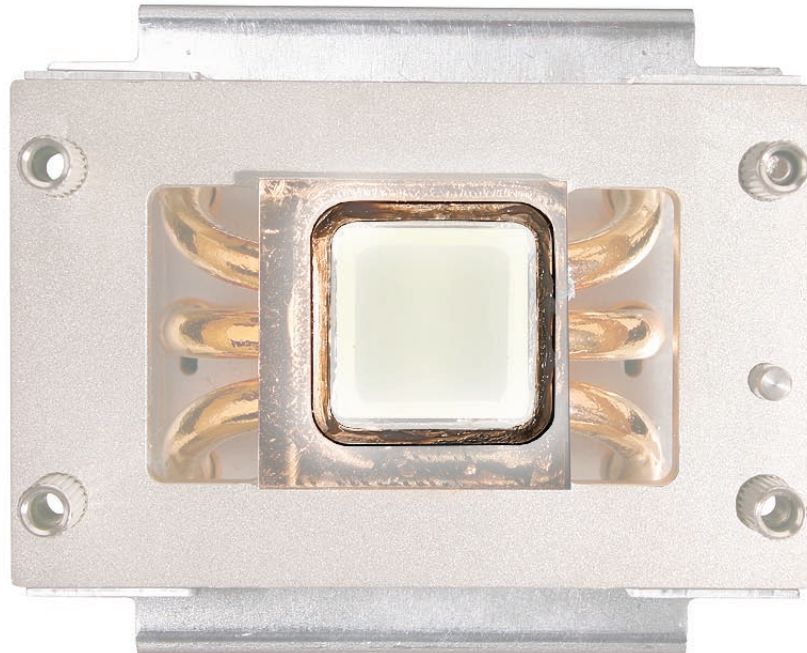

Replace the gasket if it shows obvious damage, such as cracks, folds, and broken-off surfaces, or if it is dislocated from the heatsink. The gasket is available through GSX as part of the Mac Pro Grease Kit, part number 076-1258.

Replacement Instructions for Krytox Grease

The Mac Pro (8x) uses Krytox grease to ensure a proper seal between the heatsink and processor. A bead of the grease rims the gasket on the underside of the heatsink and comes pre-applied on replacement heatsinks.

Re-installing Existing Heatsinks/Processors

If you are re-installing existing heatsinks and processors, or transferring existing heatsinks and processors to a replacement logic board, in most cases you do not need to reapply Krytox grease. However, if additional grease must be added, do the following:

- Order the Mac Pro (8x) Grease Kit (part number 076-1258).
- Reassemble the unit while you wait for the kit to arrive.
- Once you have the kit, remove the heatsink and/or processor from the enclosure.
- Using first the lint-free cloth and then the alcohol wipe from the grease kit, carefully clean off any residual grease from the underside of the heatsink and the top of the processor. (See [“Installing New Heatsinks”](#) below for more information.) Finish wiping the surfaces one more time with the cloth.

-
- Using the pre-measured syringe of Krytox grease from the kit, evenly apply a bead of grease around the full perimeter of the heatsink gasket. Apply the full syringe of grease to the gasket.

Warning: Do not apply more grease than recommended. The grease must not overflow the heatsink and come in contact with the processor connector.

- Do not apply any grease to the processor.

Installing New Processors

Do not apply new grease to either the heatsink or the processor.

Installing New Heatsinks

If you are installing a new heatsink, do not apply new grease to either the heatsink or processor, as the replacement heatsink comes with the full capacity of grease applied.

Note: When installing a new heatsink, be sure to remove any residual grease from the top edges of the heatsink's processor. To clean off the grease, do the following:

- Remove the processor from its holder on the logic board. (See "[Processors](#)" in this chapter.)
- Using first the lint-free cloth and then the alcohol wipe included with the replacement heatsink, carefully clean off any grease from the top edges of the processor. Be very careful not to touch the silver-colored coating on the top of the processor and the gold pins on the bottom of the processor.

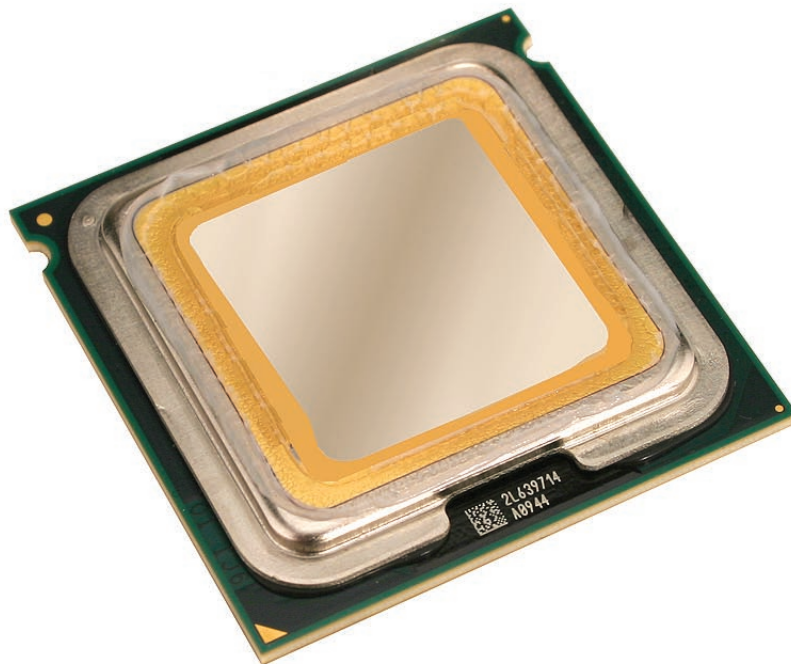

- Use the cloth to carefully wipe the top edges of the processor one more time to clean off any remaining grease.

Replacement Instructions for Heatsink

IMPORTANT:

If you are installing a new heatsink, do not remove it from its vacuum-packed bag until you are ready to install it. Be sure to follow all directions for unpacking the heatsink that are included in its packing box.

Note: If you are re-installing an existing heatsink, go directly to step 1 below. If you are installing a replacement heatsink, first do the following:

- Unpack the new heatsink according to the instructions included in the parts box.
- Remove the protective cap covering the underside of the heatsink and transfer it to the heatsink you are returning to Apple.

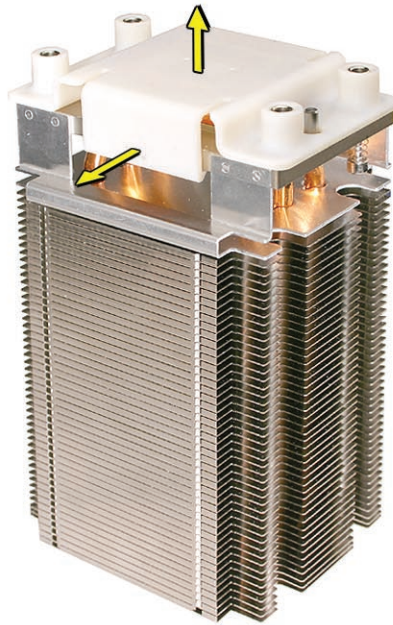

- Apply the top gasket included in the parts box to the top of the heatsink.

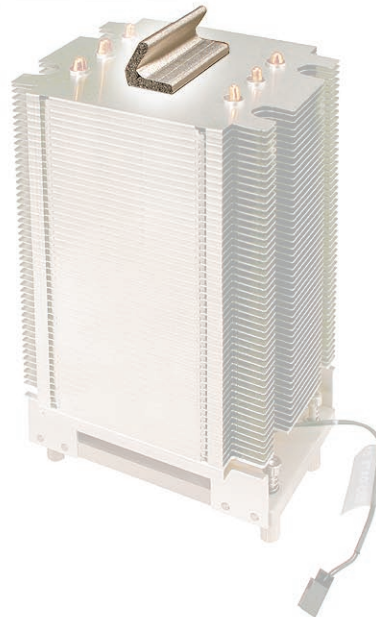

- If you are replacing the lower processor heatsink with a new heatsink, install the bumper included in the parts box on the side of the heatsink.



1. Visually inspect the gasket on the underside of the heatsink. See [“Visual Inspection of Heatsink Gasket”](#) earlier in this procedure.
2. Carefully align the posts on the lower heatsink with the mounting holes in the logic board, and lower the heatsink onto the processor.
3. Lightly tighten the heatsink mounting screws in the order indicated below.

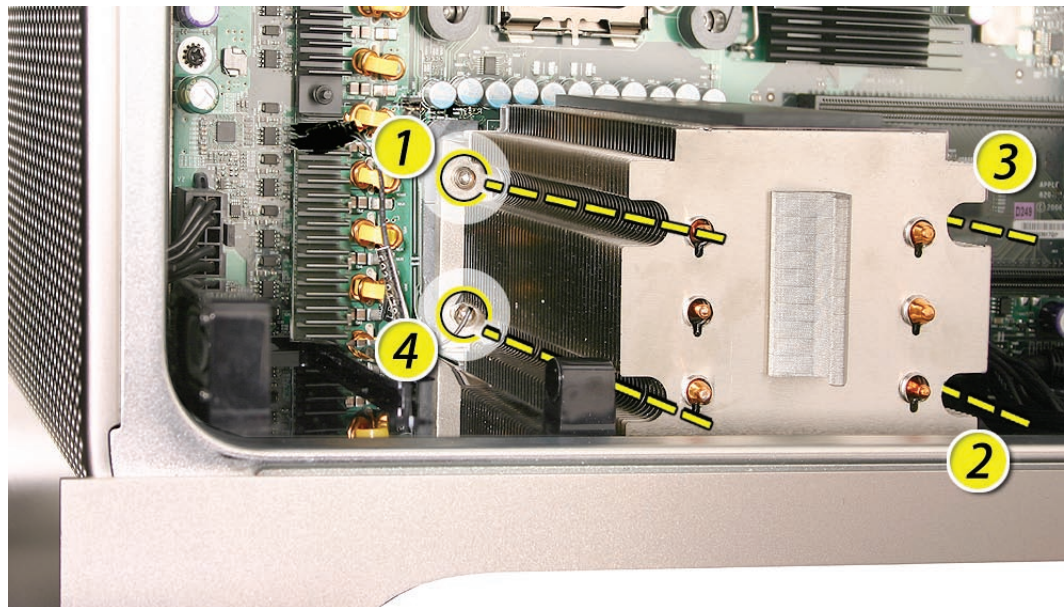

4. To secure the heatsink to the processor, again tighten the screws in the order indicated.
5. Repeat steps 1–4 for the upper processor heatsink.

Disposal Instructions

Place all disposable materials used in removing or replacing a processor heatsink or processor inside the resealable plastic bag included with the replacement module. (Disposable materials include such items as protective gloves, alcohol wipes, lint-free cleaning cloths, Krytox grease and syringe, suction pipette, and heatsink gasket.) Pack this bag along with the failed module in the box that the replacement module came in, and return the box to Apple.



Processors



30

IMPORTANT:

If you need to install a new heatsink or processor, reassemble the unit while you are waiting for the new part to arrive.

The Mac Pro (8x) computer uses a special coating on the processor heatsink and processor to manage the temperature in the computer. The silver-colored coating comes applied to the underside of the heatsink and the top of the processor.

Use the following guidelines when handling the processor heatsink and/or processor:

- Wear disposable nitrile or latex gloves.
- Avoid touching the silver-colored coating on the underside of the heatsink and the top of the processor.
- Always make a visual inspection of new or existing heatsinks and processors before installing them in the computer. See [“Processor Heatsink and Processor Visual Inspection Instructions”](#) in the Troubleshooting chapter for more information.
- When removing or replacing the heatsink and/or processor, do not allow the heatsink to be separated from the processor for more than 30 minutes. The special coating on the heatsink and processor degrades with exposure to air; more than 30 minutes exposure could result in damage to the computer and a repeat, multi-part repair.

Identifying Version 1 and Version 2 Processors

There are two versions of the processor, Version 1 and Version 2, which must be replaced like-for-like. **In addition, both processors in a dual configuration must be the same version, either Version 1 or Version 2.** Different versions in the same computer could cause a system failure.

Note: You may still replace a single processor, but you must replace it like for like. There is no performance advantage to either version of the processor.

To identify the correct processor for the computer you are repairing, please check its configuration code (the last three alphanumeric characters in the serial number for the computer). The following table lists the configuration codes that use Version 2 processors; all other configuration codes use Version 1 processors. If you do not have the correct processor, please order it from GSX.

Configuration Code	Version 2 Processor
OLN, OLS, OLT, OLU, O8S, OGP	3.0 GHz (661-4611)

Tools

No tools are required for this procedure. However, you may find a flat-blade screwdriver helpful in releasing the processor holder latch.

Preliminary Steps

Before you begin, open the computer, lay it on its side with the access side facing up, and remove the following:

- [Hard drives and hard drive carriers in drive bays 1 and 2](#)
- [PCI Express card installed in slot 1](#)
- [Any 12-inch PCI Express cards](#)
- [Processor heatsink cover](#)
- [Front fan assembly](#)
- [Top and bottom memory cards with DIMMs](#)
- [Memory cage with rear fan](#)
- [Processor heatsinks](#)

Part Location



Procedure

Note: This procedure illustrates how to remove the lower processor (CPU B). The instructions are the same for removing the upper processor (CPU A). You may, however, want to use a flat-blade screwdriver to release the latch on the upper processor.

1. Release the latch on the metal processor holder.

Note: You may want to use a flat-blade screwdriver to release the latch on the upper processor.

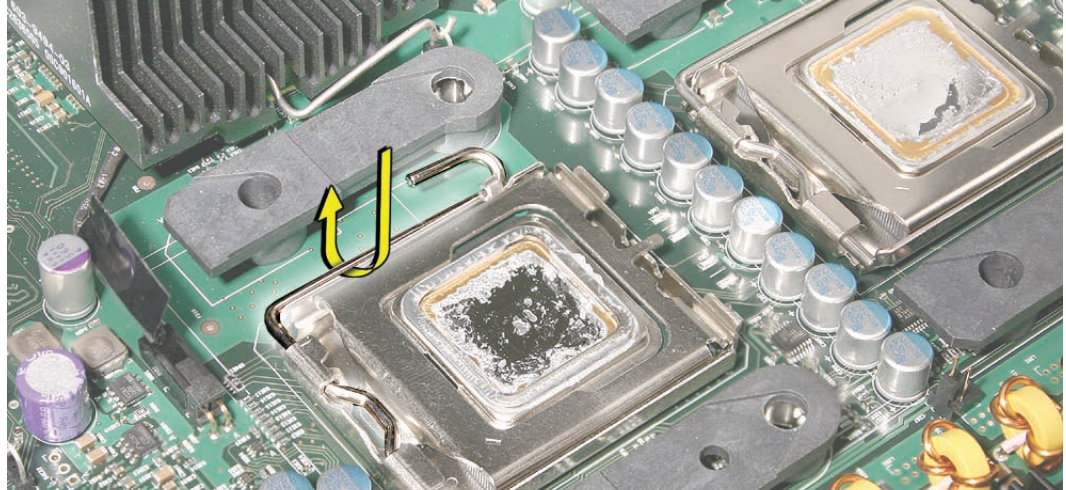

2. Rotate the top of the holder to the open position.

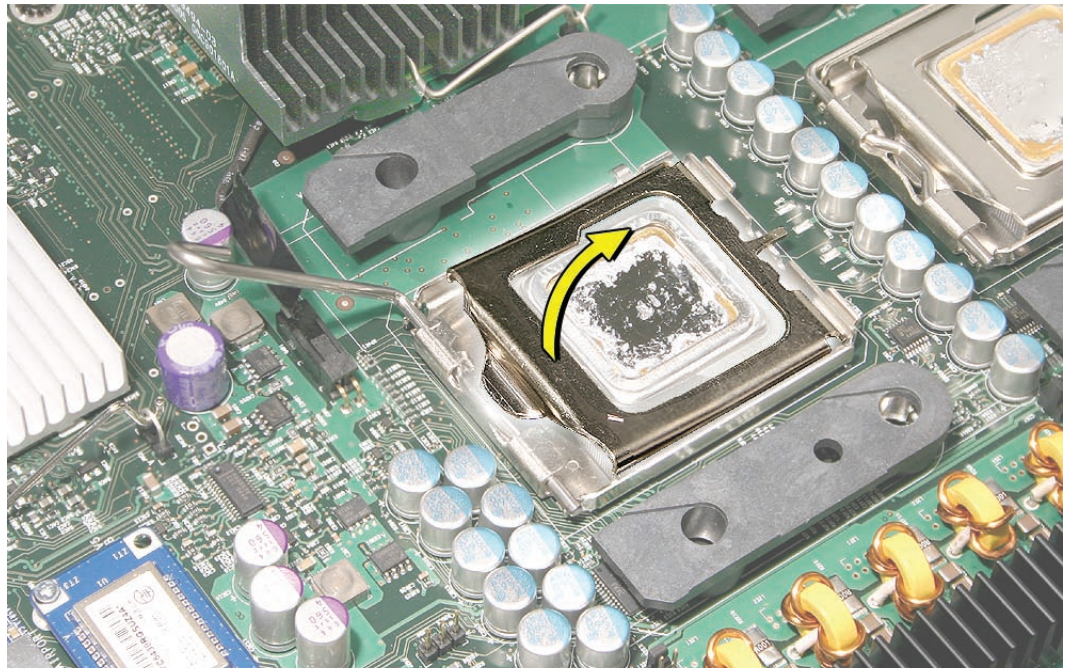

3. Placing a finger in the notch at the front of the processor holder, pry up the processor and lift it out of the holder.

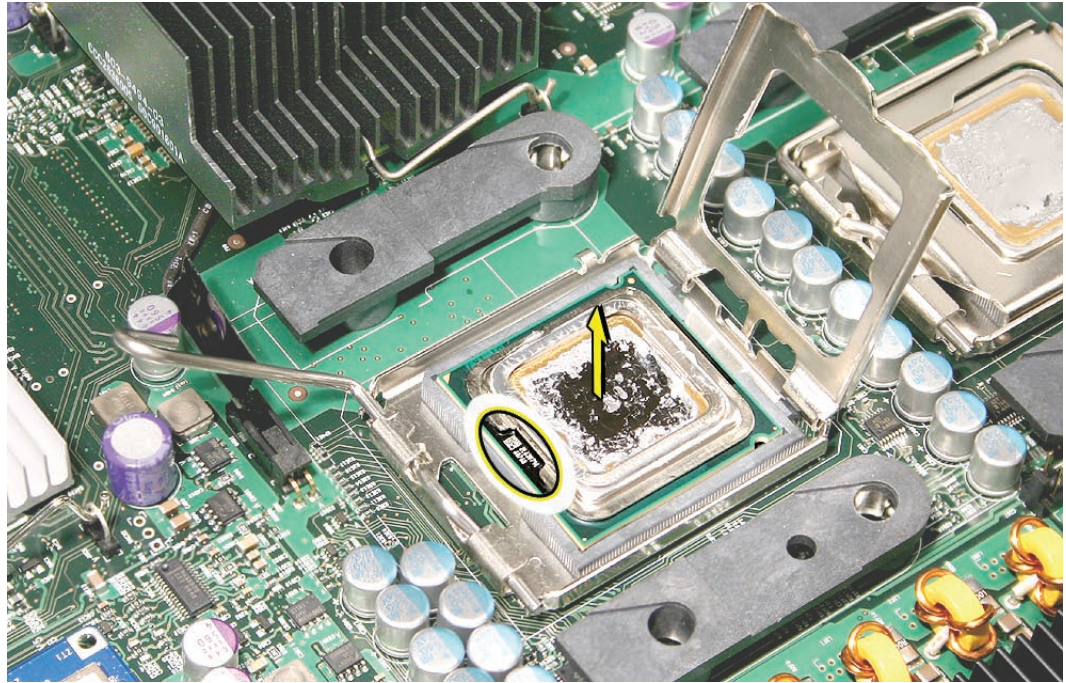

Important: When removing or installing a processor, always hold the processor by the edges. Be extremely careful not to touch the gold pins on the bottom of the processor, as this type of connector is very sensitive to contamination. Also be careful not to touch the gold pins in the processor socket on the logic board.

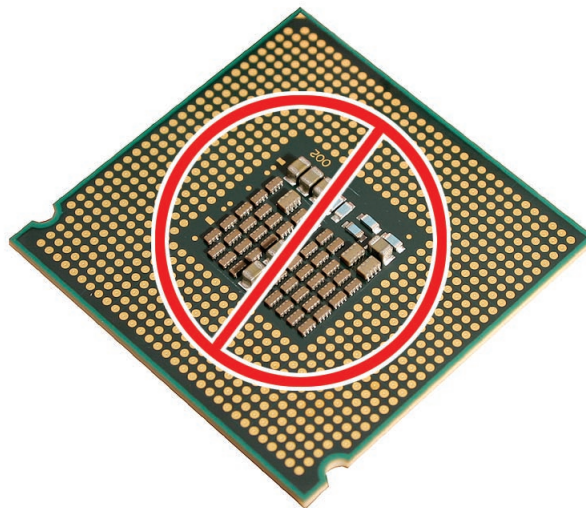

IMPORTANT:

If you are installing a new processor, do not remove it from its vacuum-packed bag until you are ready to install it. Be sure to follow all directions for unpacking the processor that are included in its packing box.

Replacement Note: Before installing a new, replacement processor, remove the protective container covering the new processor. Transfer the container to the original processor before returning it to Apple.

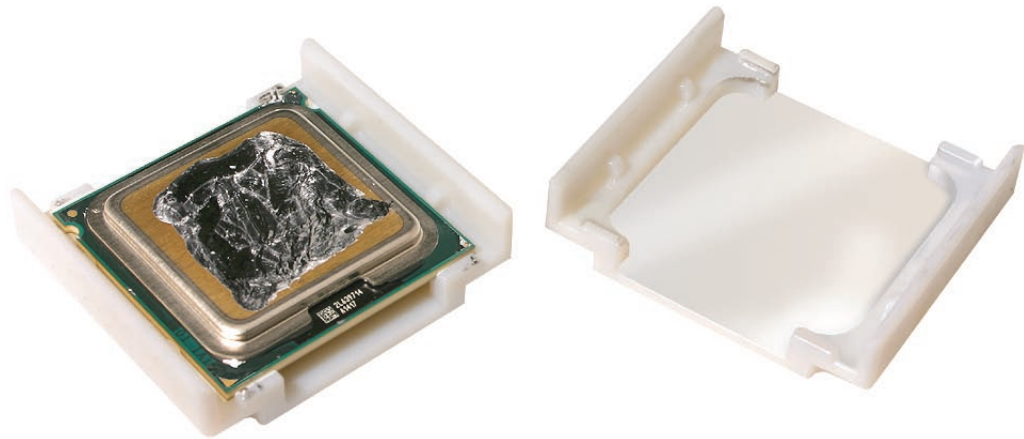

Replacement Note: When installing the processor on the logic board, align the processor notch with the tab on the processor holder, as illustrated. Then lower the processor straight down onto the socket.

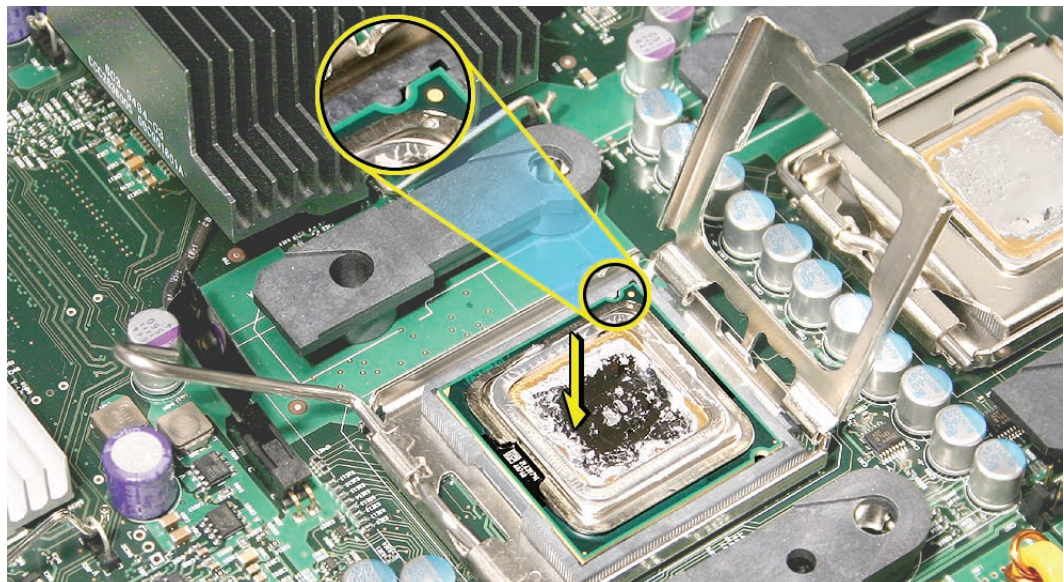

Note: Unlike in earlier Power Mac G5 computers, replacing a processor in Mac Pro (8x) does not require running Apple Service Diagnostic for thermal calibration.

Important: For the new processor to perform properly, the logic board must be upgraded to the latest version of the BootROM. You can download the latest version from the Apple support web site: <http://www.apple.com/support/downloads/>

Specifically, see [KnowledgeBase article 303880, "Firmware Updates for Intel-based Macs."](#)



Speaker Assembly

Tools

The only tools required for this procedure are a magnetized #1 Phillips screwdriver and a magnetized jeweler's #0 Phillips screwdriver.

Preliminary Steps

Before you begin, open the computer, lay it on its side with the access side facing up, and remove the following:

- [Hard drives and hard drive carriers in drive bays 1 and 2](#)
- [Any 12-inch PCI Express cards](#)
- [Processor heatsink cover](#)
- [Front fan assembly](#)

Part Location

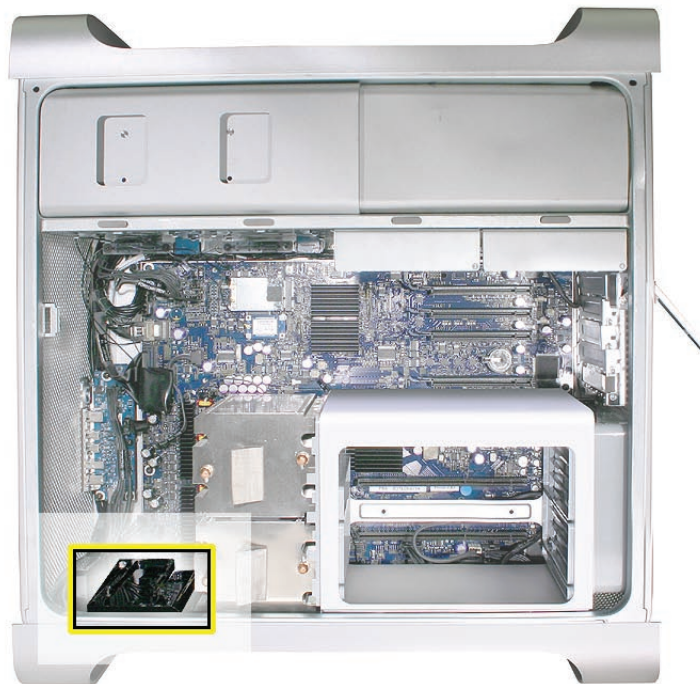

Procedure

1. Remove the three speaker assembly mounting screws.
2. Carefully pivot the speaker assembly a short distance away from the enclosure.



3. Disconnect the speaker assembly cable from the logic board.

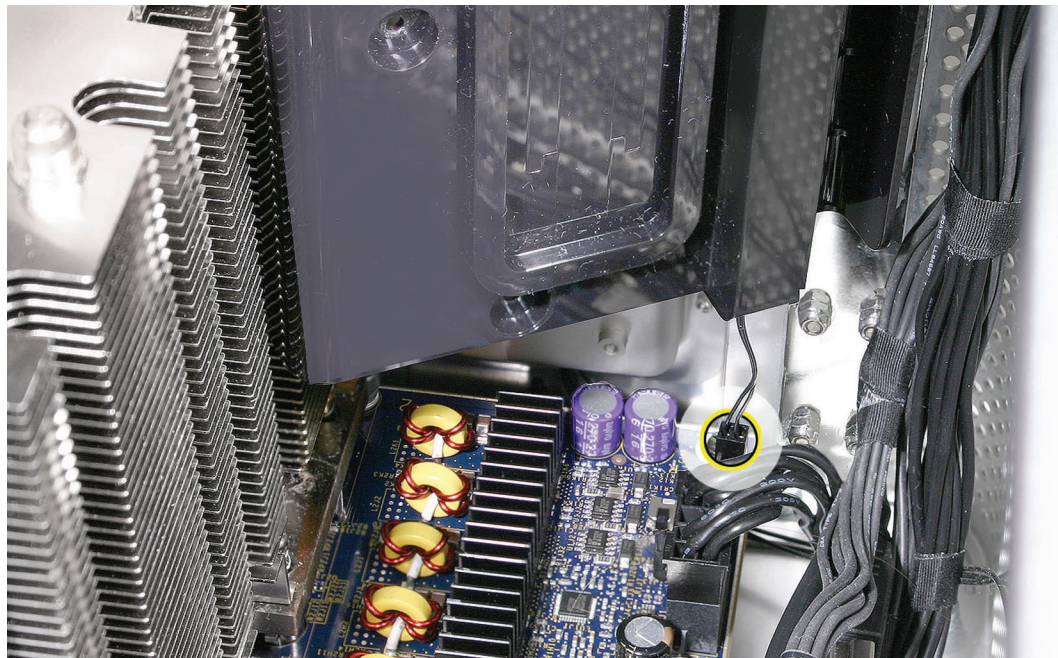

4. Remove the speaker assembly from the computer.

-
5. If you are replacing the speaker in the assembly bracket, do the following:
 - Slide the speaker cable through the opening in the speaker bracket.
 - Using a magnetized jeweler's #0 Phillips screwdriver, remove the four mounting screws.

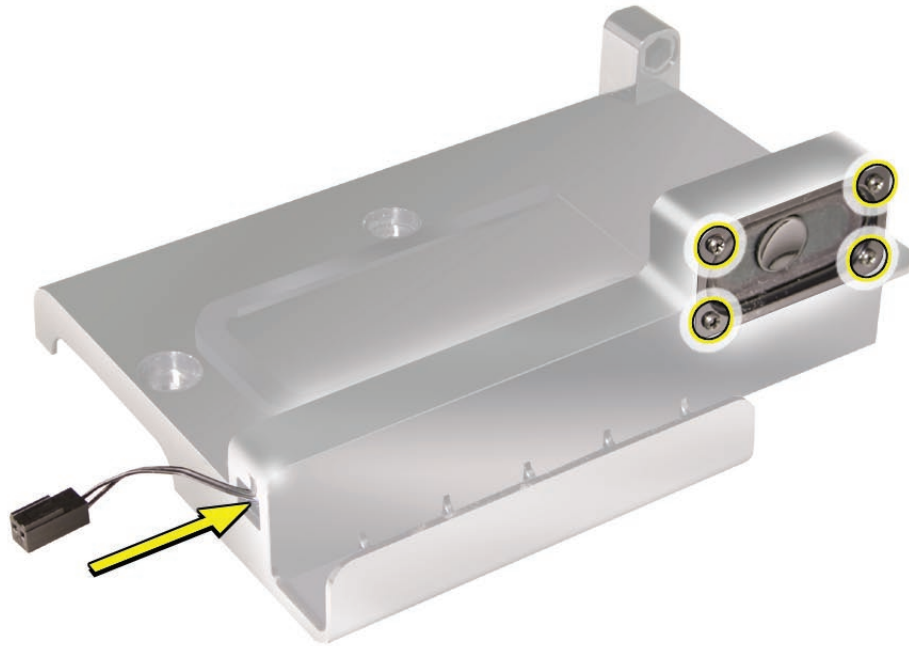

6. Remove the speaker and cable from the bracket.



USB Cable

Tools

No tools are required for this procedure.

Preliminary Steps

Before you begin, open the computer, lay it on its side with the access side facing up, and remove the following:

- [Hard drives and hard drive carriers in drive bays 1 and 2](#)
- [Any 12-inch PCI Express cards](#)
- [Processor heatsink cover](#)
- [Front fan assembly](#)

Part Location

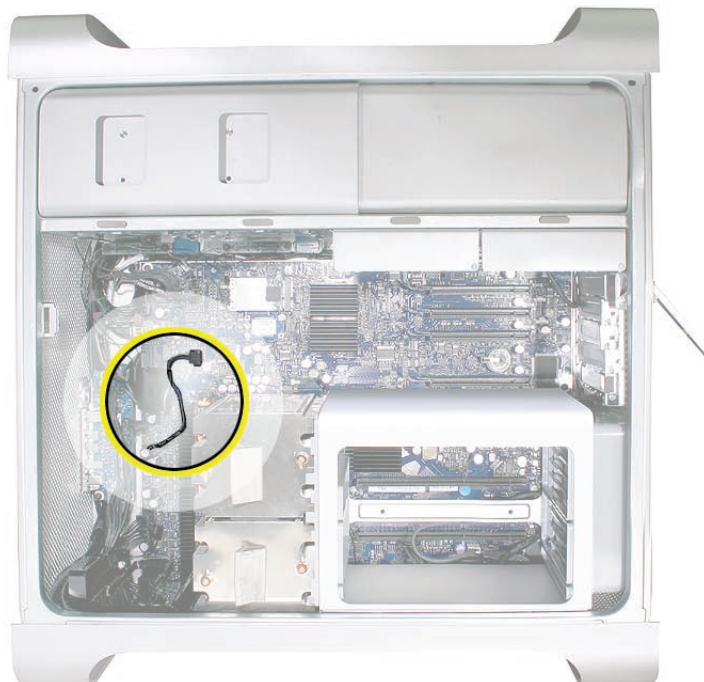

Procedure

1. Disconnect the USB cable from connector J201 on the front panel board.
2. Disconnect the USB cable from connector J2D1 on the logic board.

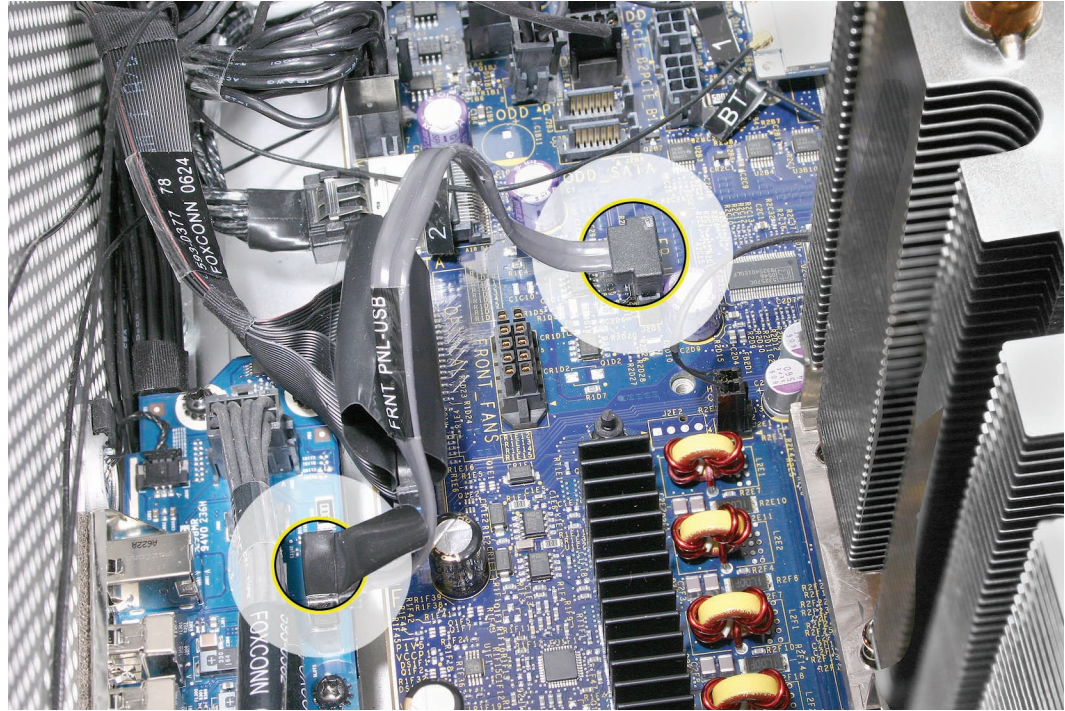

3. Remove the cable from the enclosure.



Logic Board

Note: Every time you remove the logic board, you must also remove the two processor heatsinks. See special instructions for handling the heatsinks in “[Processor Heatsinks](#)” in the Take Apart chapter.



Tools

The only tool required for this procedure is a magnetized Phillips #1 screwdriver.

IMPORTANT:

Do not allow the heatsink to be separated from the processor for more than 30 minutes. If you are ordering a new logic board, reassemble the unit while you are waiting for the part to arrive.

Preliminary Steps

Before you begin, open the computer, lay it on its side with the access side facing up, and remove the following:

- [All hard drives and hard drive carriers](#)
- [All PCI Express cards](#)
- [Processor heatsink cover](#)
- [Front fan assembly](#)
- [Top and bottom memory cards with DIMMs](#)
- [Memory cage with rear fan](#)
- [Processor heatsinks](#)
- [Speaker assembly](#)
- [USB cable](#)
- [AirPort Extreme card \(if installed\)](#)
- [Bluetooth card \(if installed\)](#)

Part Location



Procedure

1. To keep them out of the way, temporarily tape the antenna cables to the bottom of the media shelf.

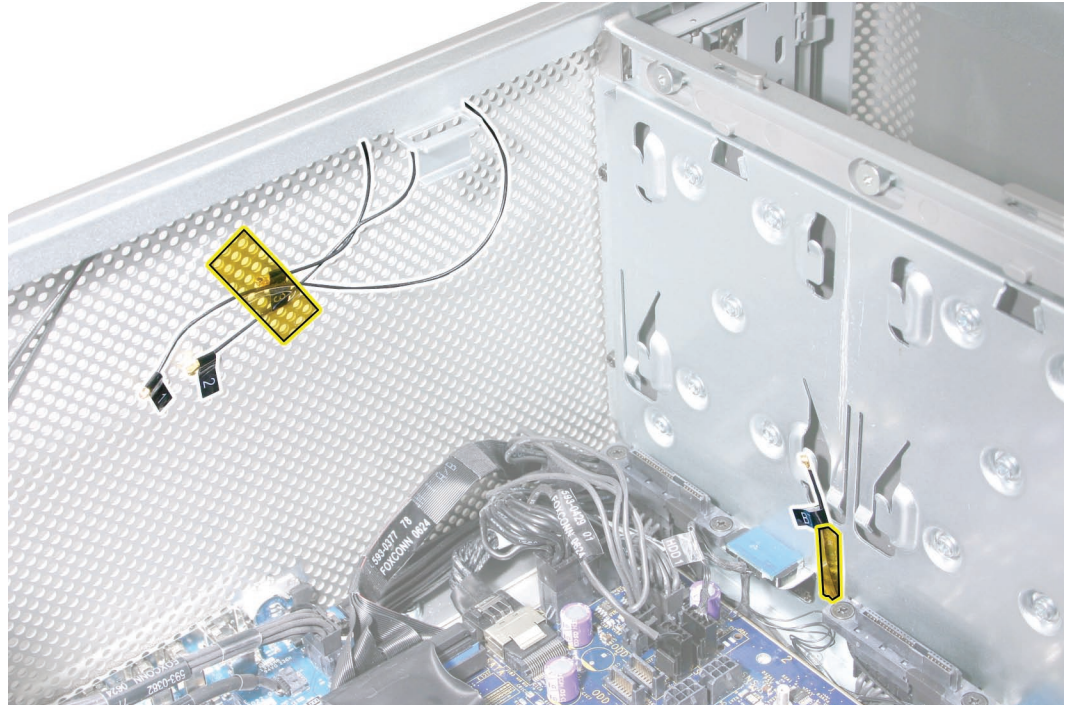

Important: Be sure to disconnect all cables from the logic board before you remove the logic board mounting screws.

2. Starting at the back panel side of the logic board and working clockwise around the board, disconnect all cables from the logic board.

Note: There are 14 cables you will be disconnecting from the logic board.

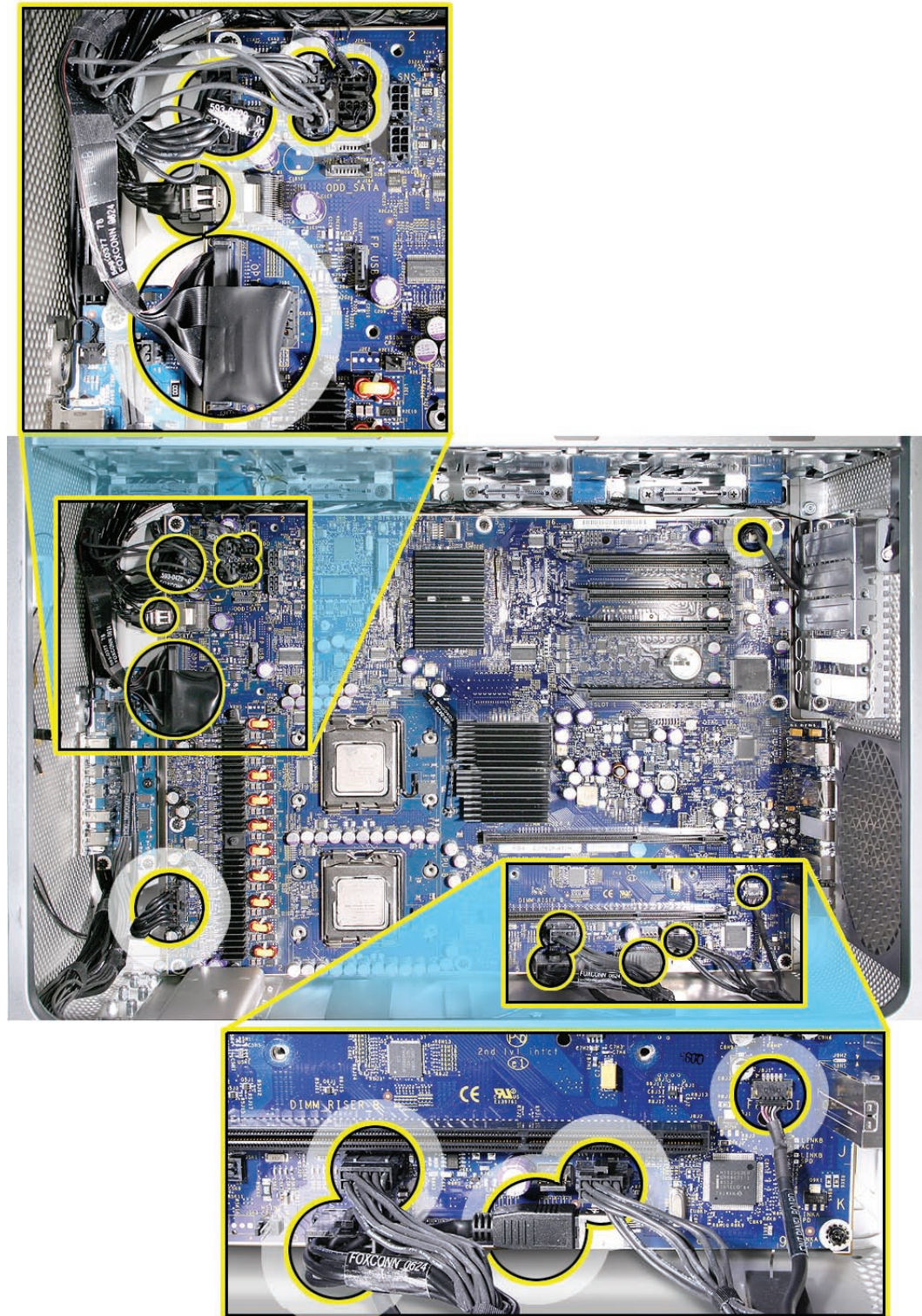

- Using a magnetized #1 Phillips screwdriver, remove the 11 black logic board mounting screws.

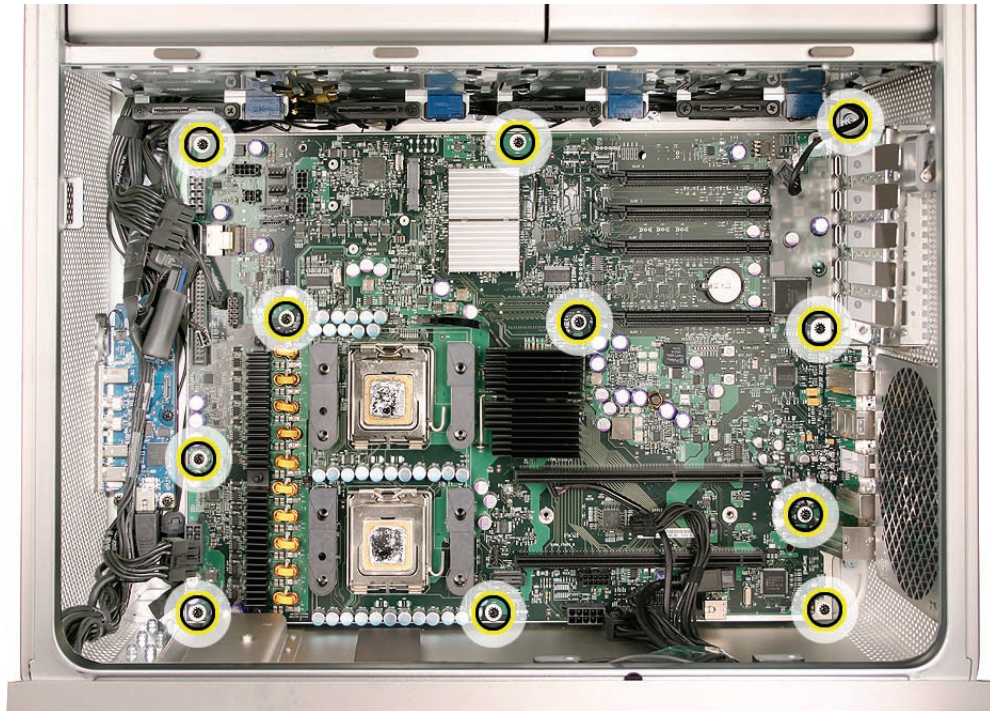

-
4. Slide the logic board back a short distance from the port openings in the back panel. Make sure the ports clear the openings.
 5. Tilt the top edge of the logic board up and maneuver the board out of the enclosure.



Replacement Note: Before replacing the logic board, check the underside of the board to be sure that all bumpers are in place. Replace any missing bumpers.

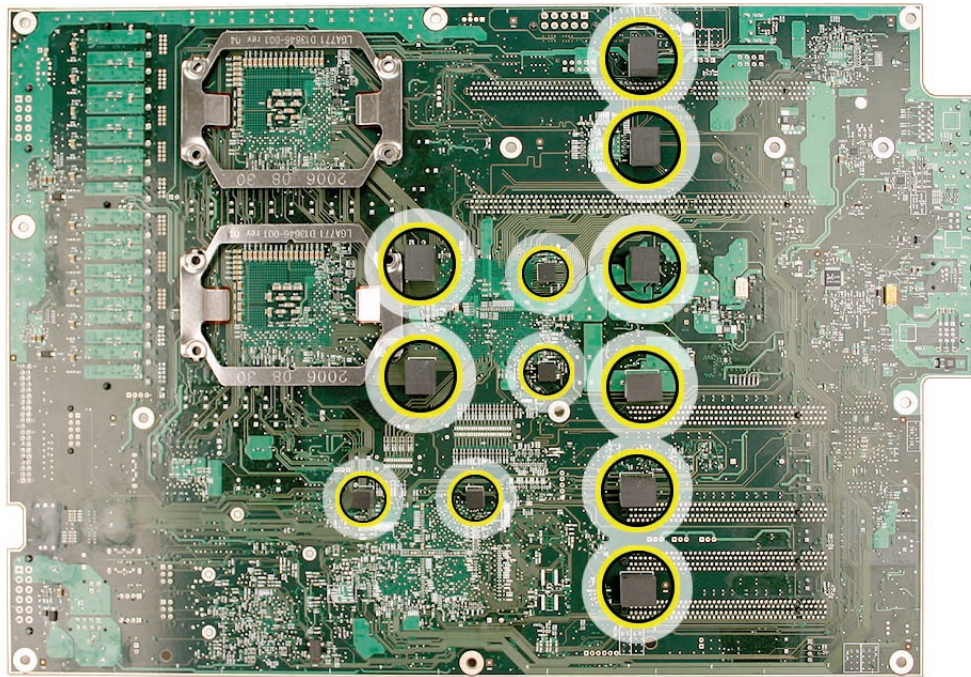

Replacement Note: If you are replacing the logic board with a new logic board, do the following:

- Remove the protective caps from the new logic board's processor holders and transfer the caps on the original logic board's processor holders. Note that logic boards returned to Apple without the protective caps may be rejected.

Warning: Be careful not to touch the gold pins in the processor socket on the logic board.

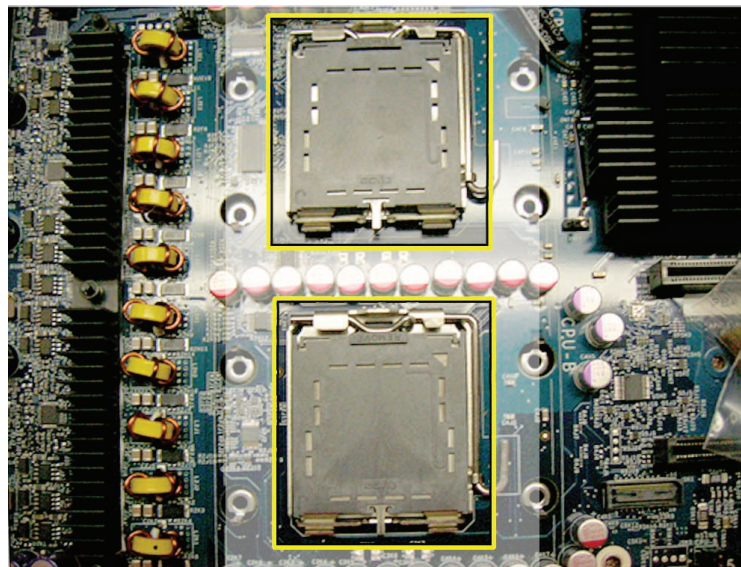

- Transfer the processors to the new board: Refer to the “[Processors](#)” topic in this chapter.
- You must also transfer the back ports EMI shield to the new board.

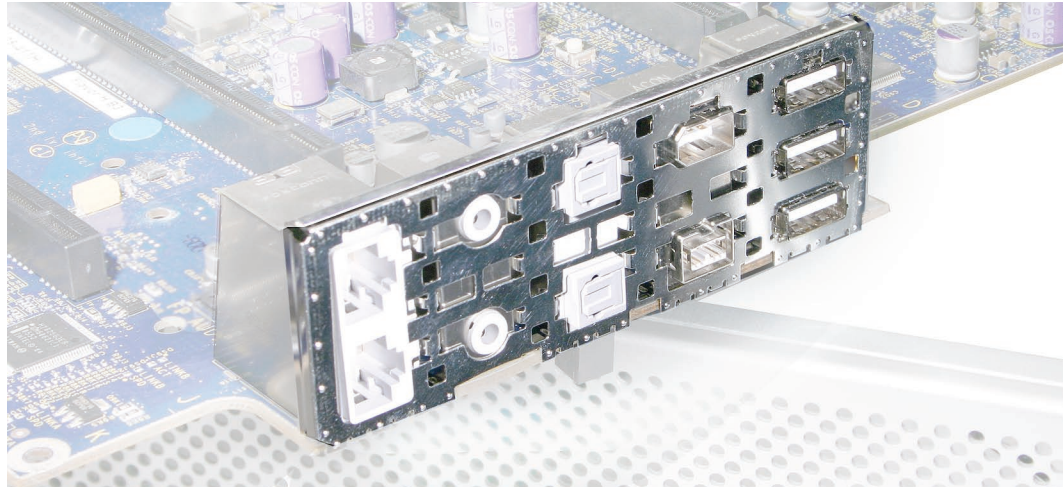

Replacement Note: To replace the logic board, tilt it as shown and lower it into the enclosure.



Note: Unlike in earlier Power Mac G5 computers, replacing a logic board in Mac Pro (8x) does not require running Apple Service Diagnostic for thermal calibration.

Important: For proper performance, all logic boards in Intel-based desktop computers and servers must be upgraded to the latest version of the BootROM. You can download the latest version from the Apple support web site:

<http://www.apple.com/support/downloads/>



Front Panel Board

Tools

The only tool required for this procedure is a long-handled, magnetized Phillips #1 screwdriver.

Preliminary Steps

Before you begin, open the computer, lay it on its side with the access side facing up, and remove the following:

- [Hard drives and hard drive carriers in drive bays 1 and 2](#)
- [Any 12-inch PCI Express cards](#)
- [Processor heatsink cover](#)
- [Front fan assembly](#)

Part Location



Procedure

1. Disconnect the optical drive ribbon cable from the logic board and move the cable out of the way.

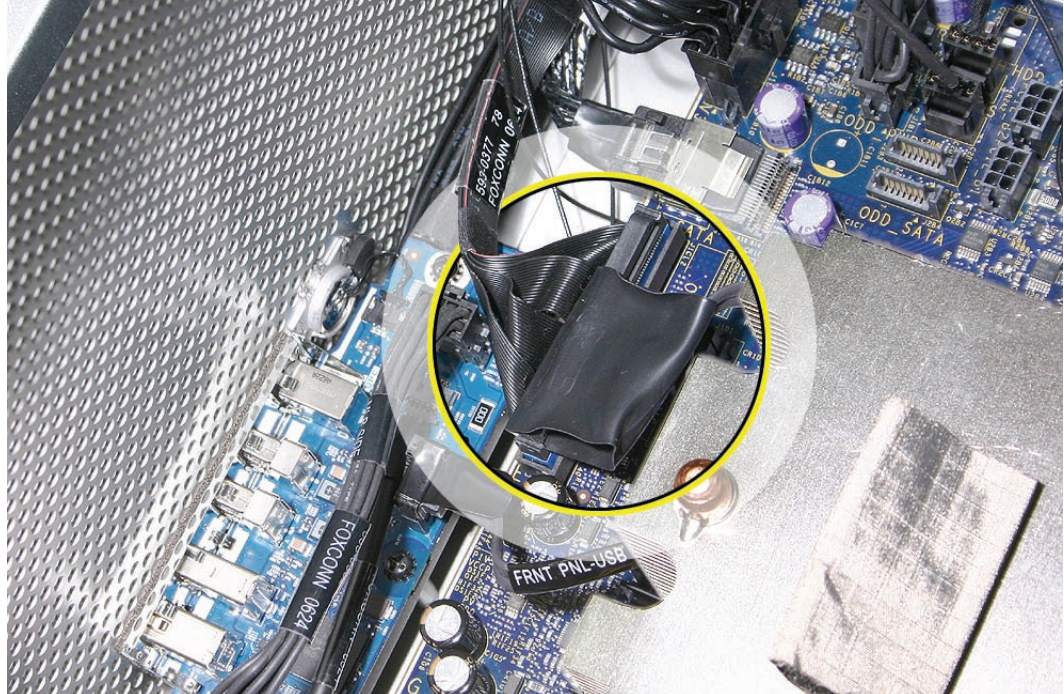

2. Disconnect the following five cables from the front panel board:
 - FireWire 800 cable from connector J200
 - USB cable from connector J201
 - Front panel board power cable from connector J202
 - Front panel board audio cable from connector J600
 - Power button cable from connector J800

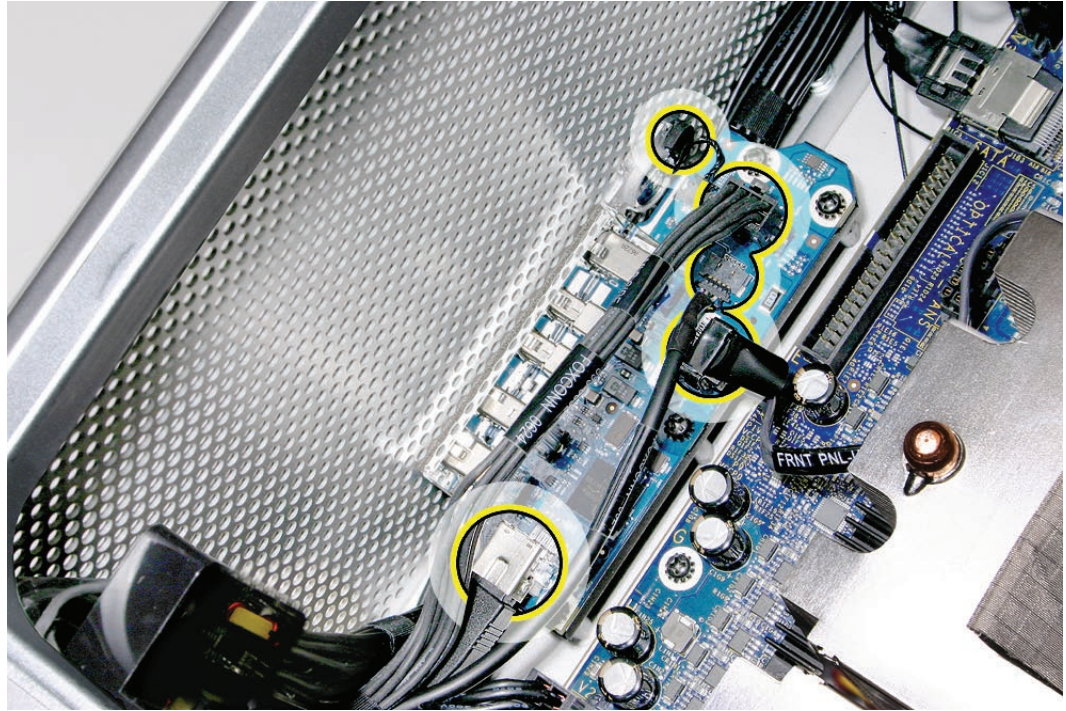

- Using a magnetized #1 Phillips screwdriver, remove the five front panel board mounting screws.

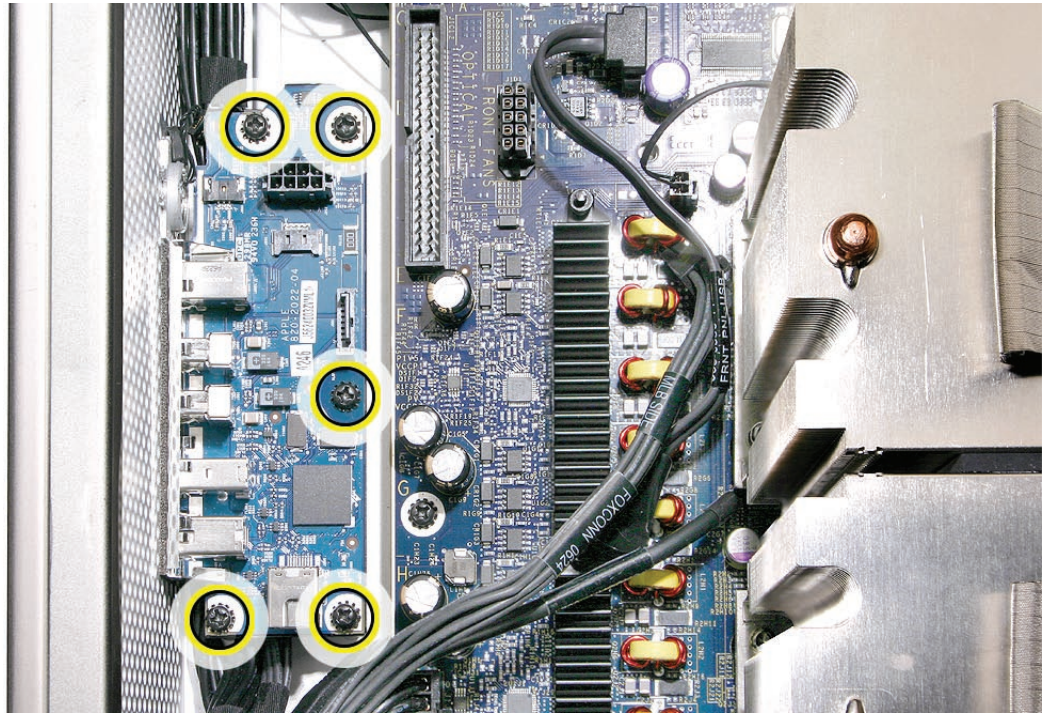

- Lift the front panel board out of the computer.

Note: If you are replacing the front panel board with a new front panel board, separate the EMI shield from the back of the board and transfer it to the new front panel board.





Power Button

Tools

The only tool required for this procedure is a jeweler's flat-blade screwdriver.

Preliminary Steps

Before you begin, open the computer, lay it on its side with the access side facing up, and remove the following:

- [Hard drives and hard drive carriers in drive bays 1 and 2](#)
- [Any 12-inch PCI Express cards](#)
- [Processor heatsink cover](#)
- [Front fan assembly](#)

Part Location



Procedure

1. Disconnect the optical drive ribbon cable from the logic board and move the cable out of the way.
2. Disconnect the front panel board power cable from the front panel board and move it out of the way.
3. Disconnect the power button cable from the front panel board.

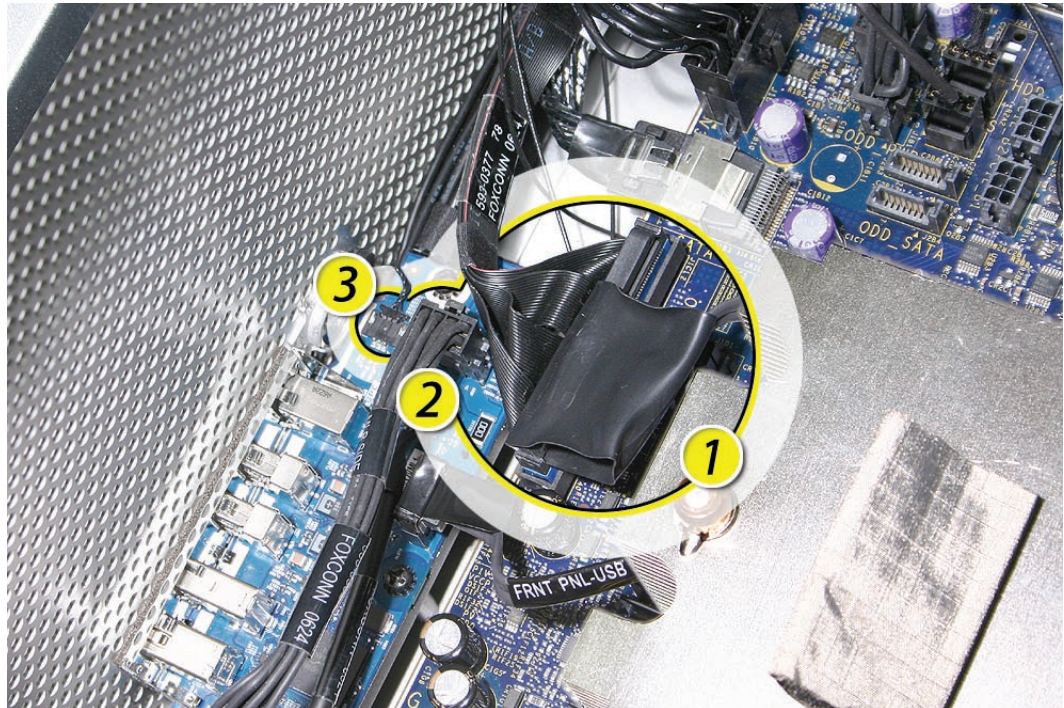

4. Lay the computer so that the front panel is facing down.

5. Remove the black rubber cap that covers the power button LED.
6. Using a jeweler's flat-blade screwdriver, pry up the metal C-ring that secures the power button board.

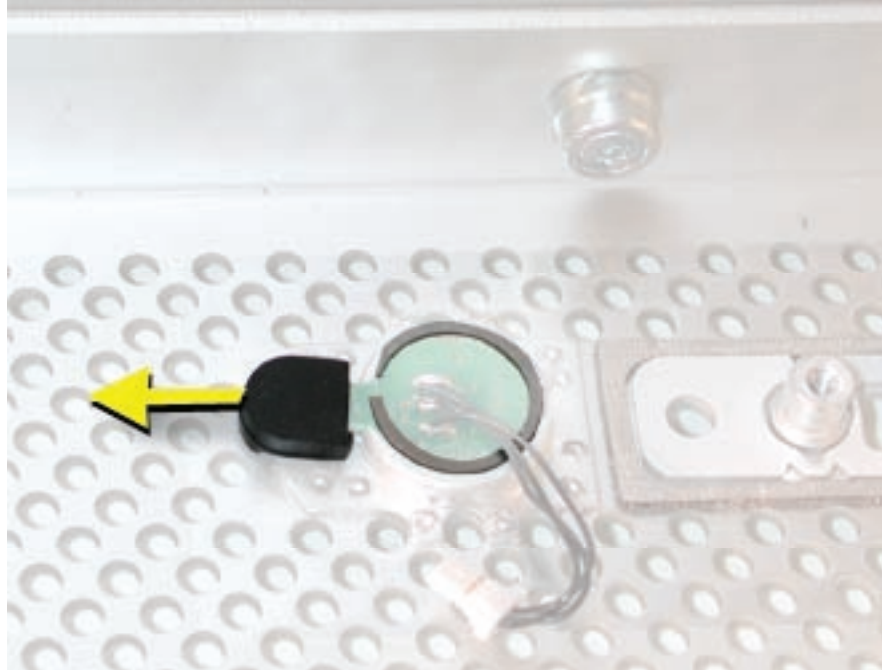

7. Lift up and remove the power button board.

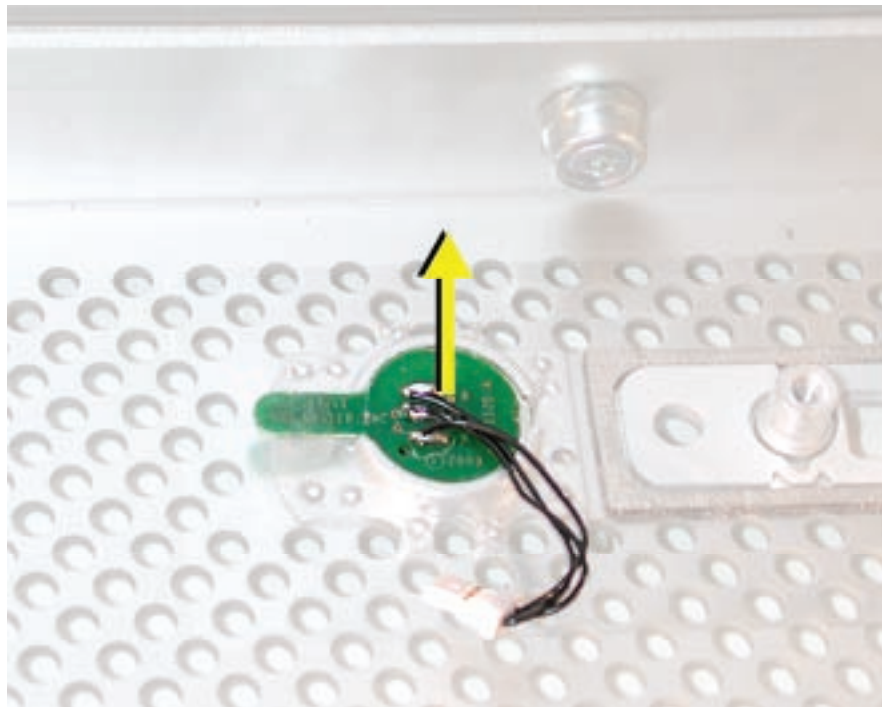

-
8. Remove the metal activation ring that lies below the power button board.

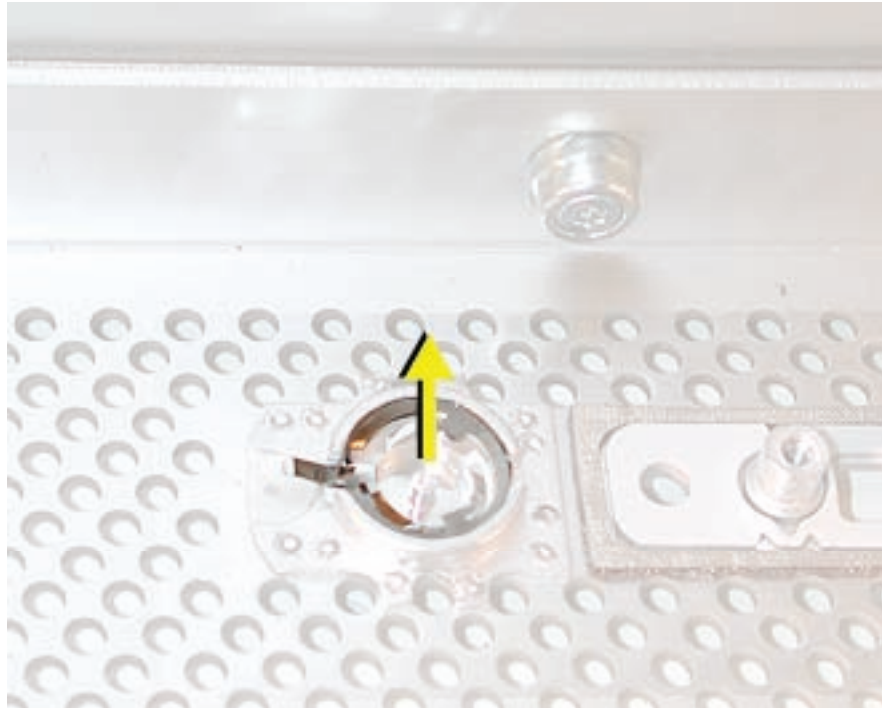

9. Remove the power button from the enclosure.

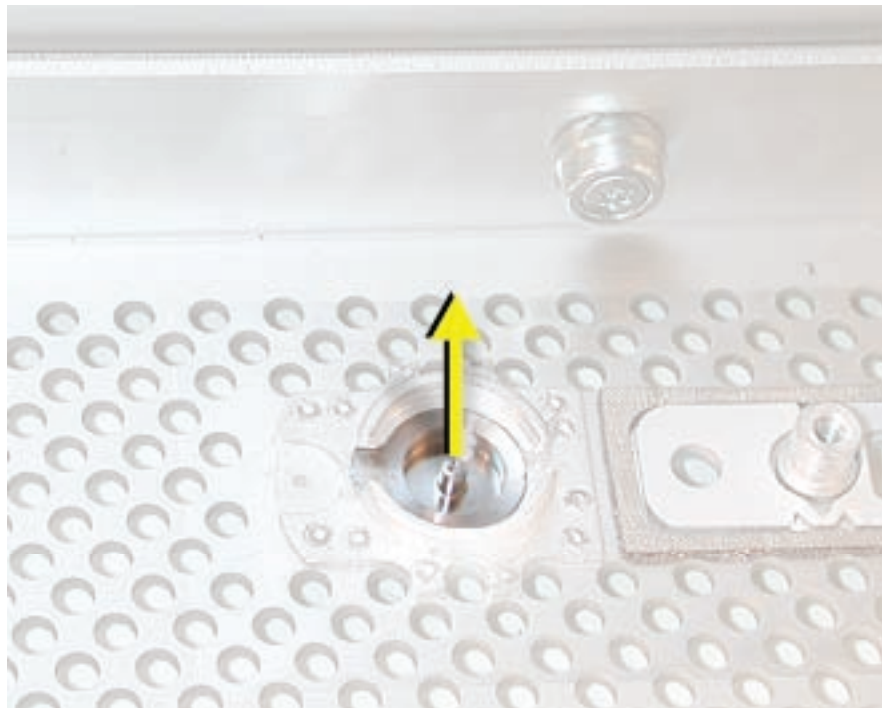



AirPort Antenna Board with Cables

The AirPort Extreme antenna cables are part of the AirPort antenna board assembly. To remove or replace the cables, you must replace the antenna board assembly.

Tools

The only tools required for this procedure are a jeweler's flat-blade screwdriver and a magnetized jeweler's Phillips #0 screwdriver.

Preliminary Steps

Before you begin, open the computer, lay it on its side with the access side facing up, and remove the following:

- [All hard drives and hard drive carriers](#)
- [All PCI Express cards](#)
- [Processor heatsink cover](#)
- [Front fan assembly](#)
- [Top and bottom memory cards with DIMMs](#)
- [Memory cage with rear fan](#)
- [Processor heatsinks](#)
- [Speaker assembly](#)
- [USB cable](#)
- [AirPort Extreme card \(if installed\)](#)
- [Bluetooth card \(if installed\)](#)
- [Logic board](#)

Part Location

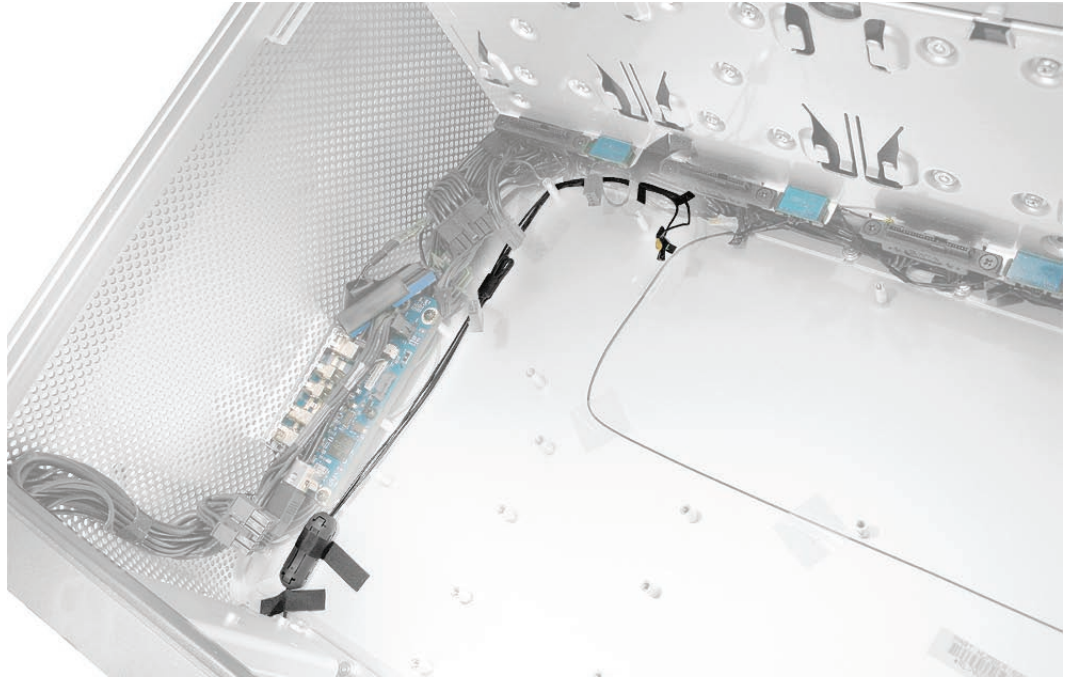

Procedure

1. Place the computer so that the bottom panel is facing you.
2. Remove the tape holding the antenna cables to the enclosure.
3. Using a jeweler's flat-blade screwdriver, pry open the three latches on the antenna cables ferrite bead and remove the bead from the cables.



- Using the jeweler's flat-blade screwdriver, carefully pry up the rectangular plastic plate on the bottom panel.



- Using a jeweler's #0 Phillips screwdriver, remove the four antenna board mounting screws.

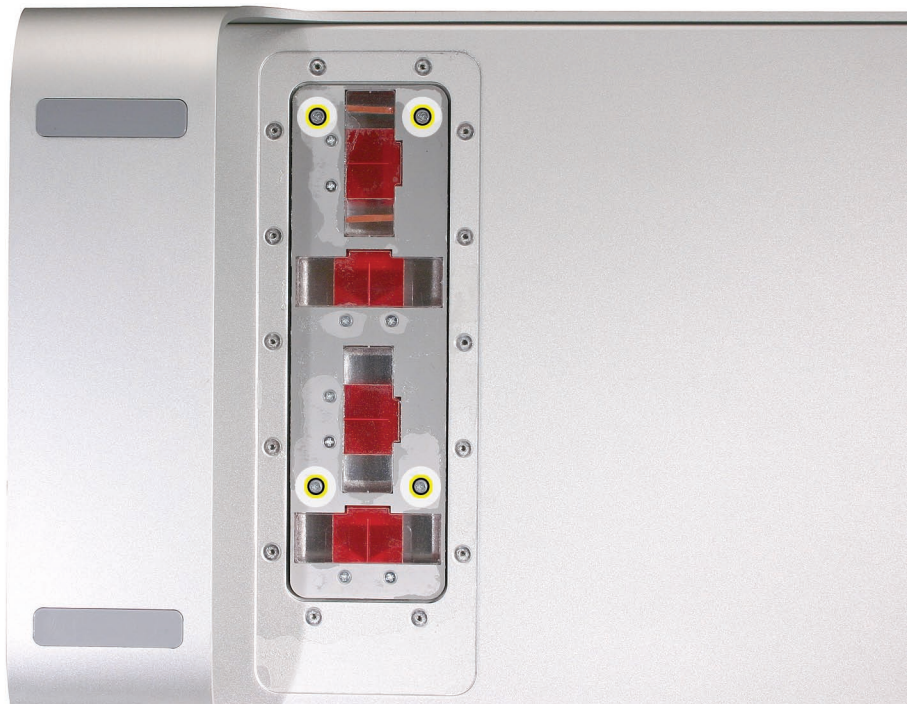

-
6. Tilt the antenna board away from the back panel a short distance.
 7. Feed each antenna cable separately out through the small opening in the bottom panel.

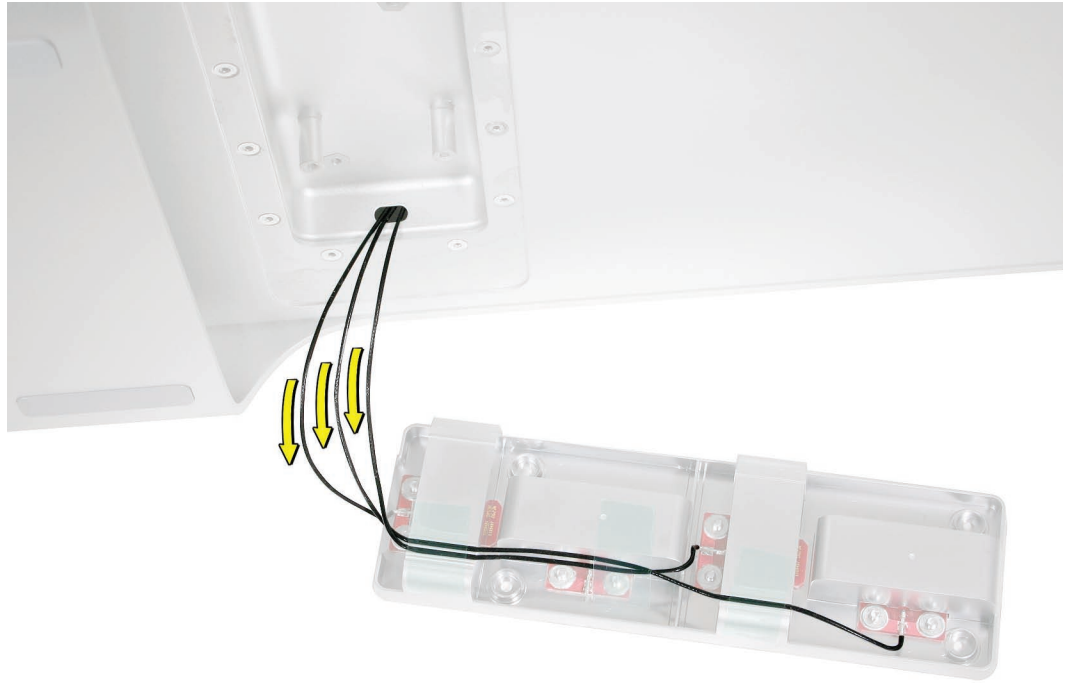

8. Remove the antenna board and cables from the enclosure.



Optical Drive Power Cable

Tools

The only tool required for this procedure is a magnetized #1 Phillips screwdriver.

Preliminary Steps

Before you begin, open the computer, lay it on its side with the access side facing up, and remove the following:

- [Optical drive carrier and optical drives](#)
- [Hard drives and hard drive carriers in drive bays 1 and 2](#)
- [Any 12-inch PCI Express cards](#)
- [Processor heatsink cover](#)
- [Front fan assembly](#)

Part Location



Procedure

1. Using a magnetized #1 Phillips screwdriver, remove the two mounting screws on the hard drive connector for drive bay 1 and move the connector out of the way.

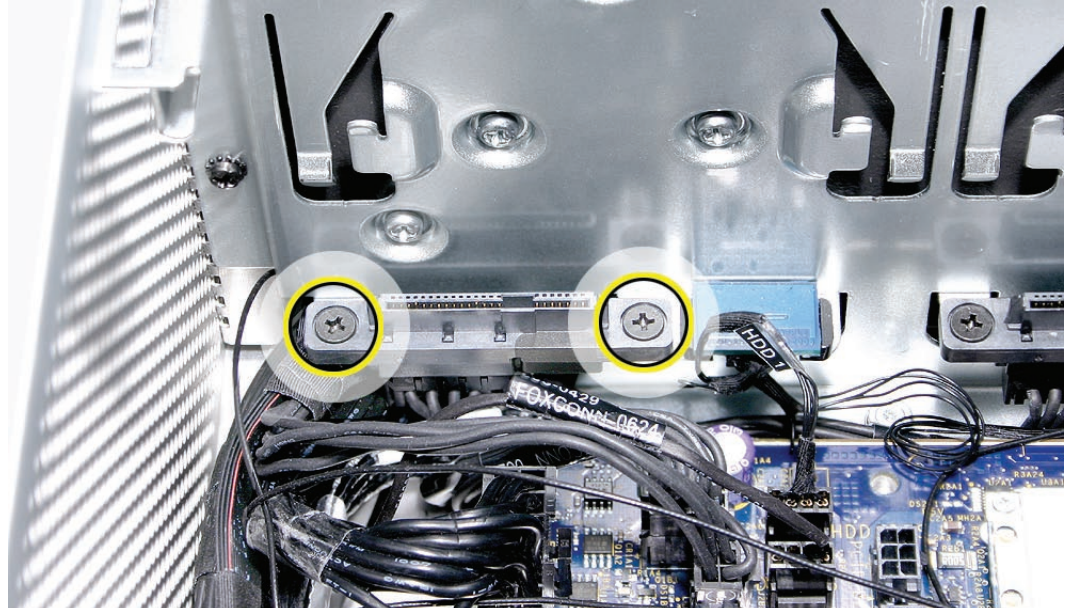

2. Unwind the tape that holds the optical drive data cable to the optical drive power cable.
3. Disconnect the optical drive power cable from the logic board.
4. Insert the logic board end of the power cable into the opening in the media shelf at hard drive bay 1 and remove the cable from the enclosure.

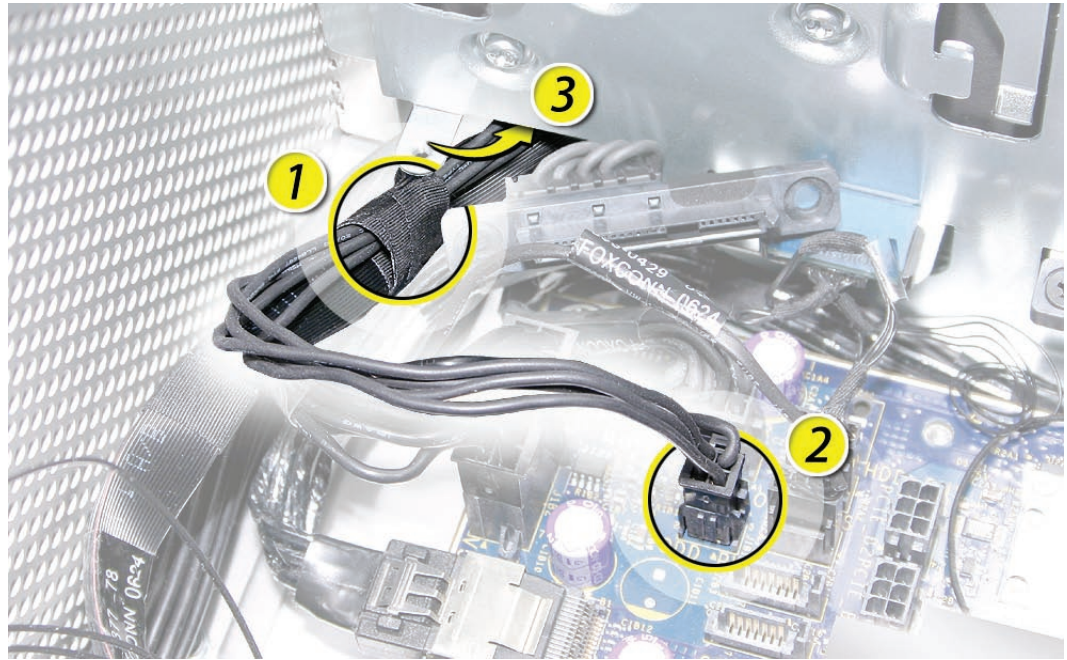



Optical Drive Data (Ribbon) Cable

Tools

The only tool required for this procedure is a magnetized #1 Phillips screwdriver.

Preliminary Steps

Before you begin, open the computer, lay it on its side with the access side facing up, and remove the following:

- [Optical drive carrier and optical drives](#)
- [Hard drives and hard drive carriers in drive bays 1 and 2](#)
- [Any 12-inch PCI Express cards](#)
- [Processor heatsink cover](#)
- [Front fan assembly](#)

Part Location



Procedure

1. Using a magnetized #1 Phillips screwdriver, remove the two mounting screws on the hard drive connector for drive bay 1 and move the connector out of the way.

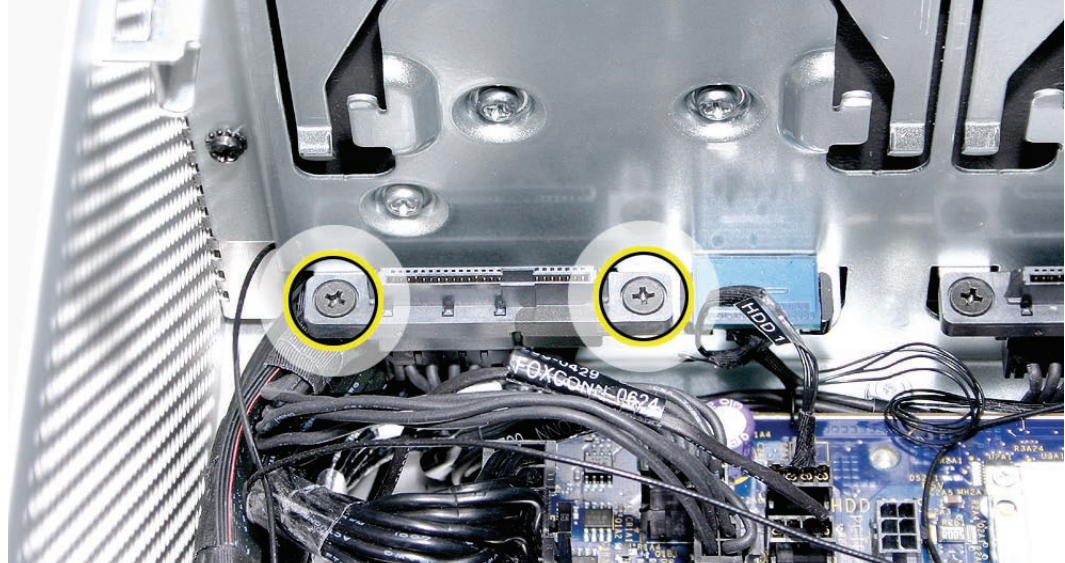

2. Unwind the tape that holds the optical drive data cable to the optical drive power cable.
3. Disconnect the optical drive data cable from the logic board.
4. Insert the cable into the opening in the media shelf at hard drive bay 1 and remove the cable from the enclosure.

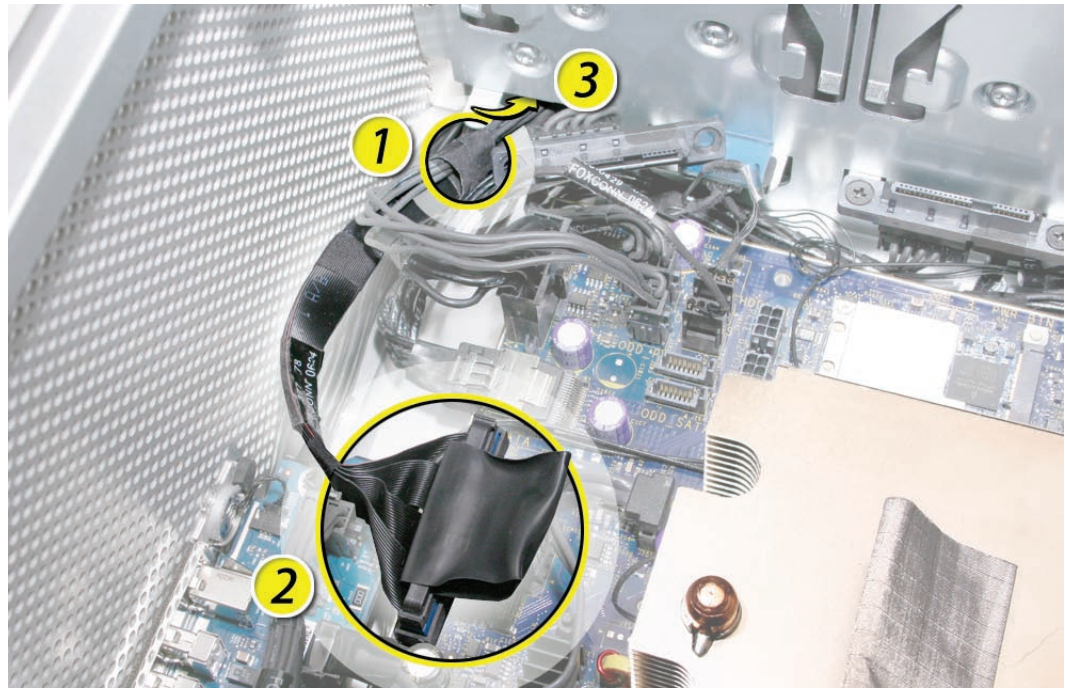



Ambient Board

Note: The ambient board is attached to the enclosure with adhesive. Once you remove the ambient board, you may have to apply new adhesive before reattaching the same ambient board. Replacement ambient boards come with adhesive already in place.

Tools

The only tools required for this procedure are a jeweler's flat-blade screwdriver.

Preliminary Steps

Before you begin, open the computer, lay it on its side with the access side facing up, and remove the [optical drive carrier and optical drives](#).

Part Location

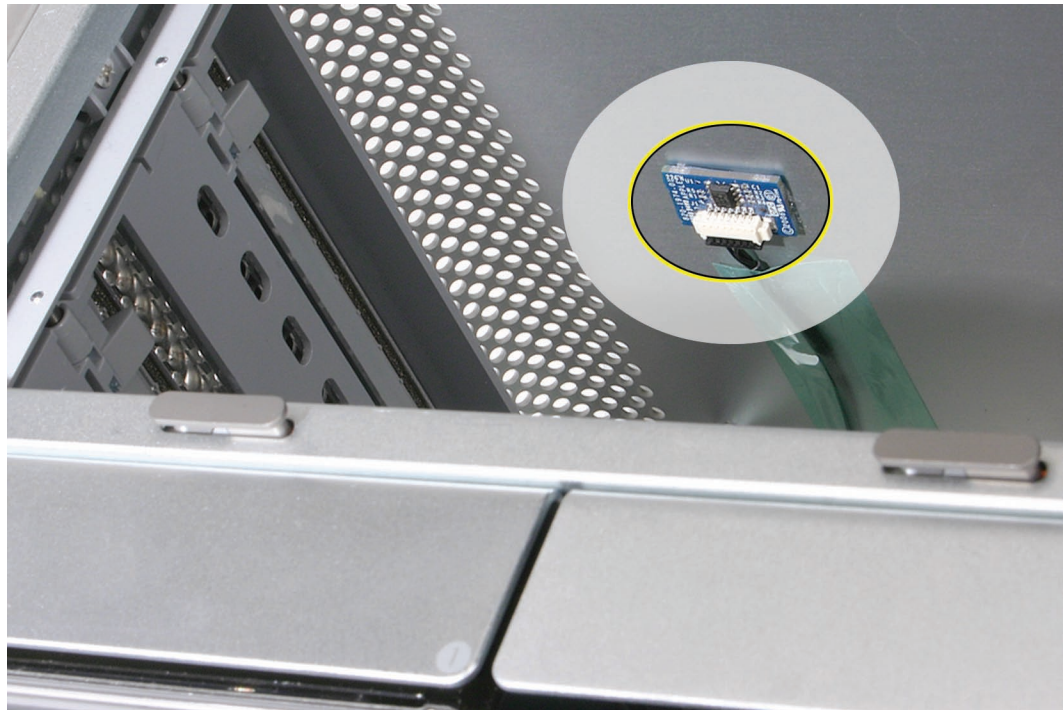

Procedure

1. Locate the ambient board on the inside left corner of the top panel, above the optical drive carrier.



2. Disconnect the ambient board cable from the ambient board.
3. Using a jeweler's flat-blade screwdriver, carefully pry the board from the enclosure.



Important: After you replace the ambient board, you must reset the System Management Controller. Refer to [“Resetting the Logic Board”](#) in the Troubleshooting chapter.



Ambient Board Cable

Tools

The only tool required for this procedure is a magnetized #1 Phillips screwdriver.

Preliminary Steps

Before you begin, open the computer, lay it on its side with the access side facing up, and remove the following:

- [Optical drive carrier and optical drives](#)
- [Hard drives and hard drive carriers in drive bays 1 and 2](#)
- [Any 12-inch PCI Express cards](#)
- [Processor heatsink cover](#)
- [Front fan assembly](#)

Part Location

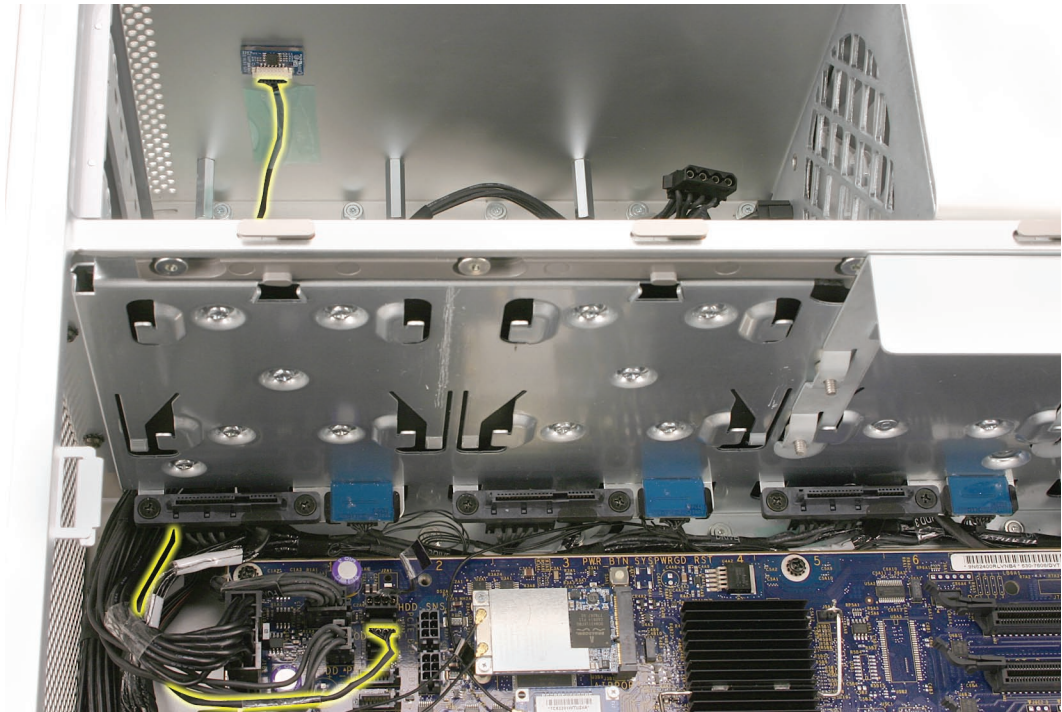

Procedure

1. Remove any tape holding the ambient board cable to the enclosure.
2. Disconnect the ambient board cable from the ambient board and logic board.

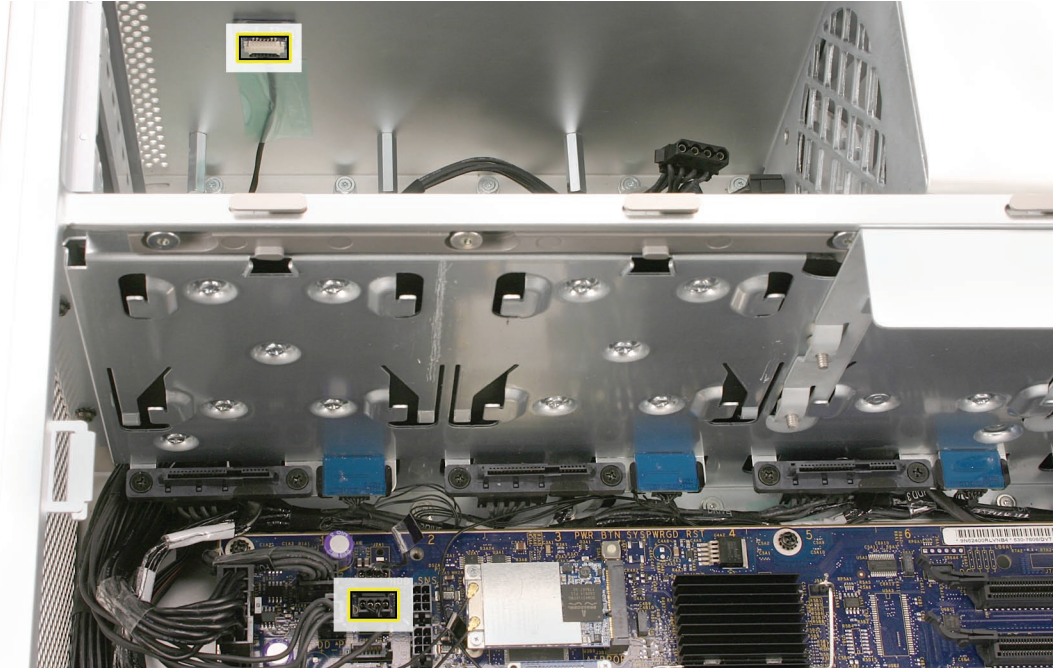

3. Using a magnetized #1 Phillips screwdriver, remove the two mounting screws on the hard drive connector for drive bay 1 and move the connector out of the way.

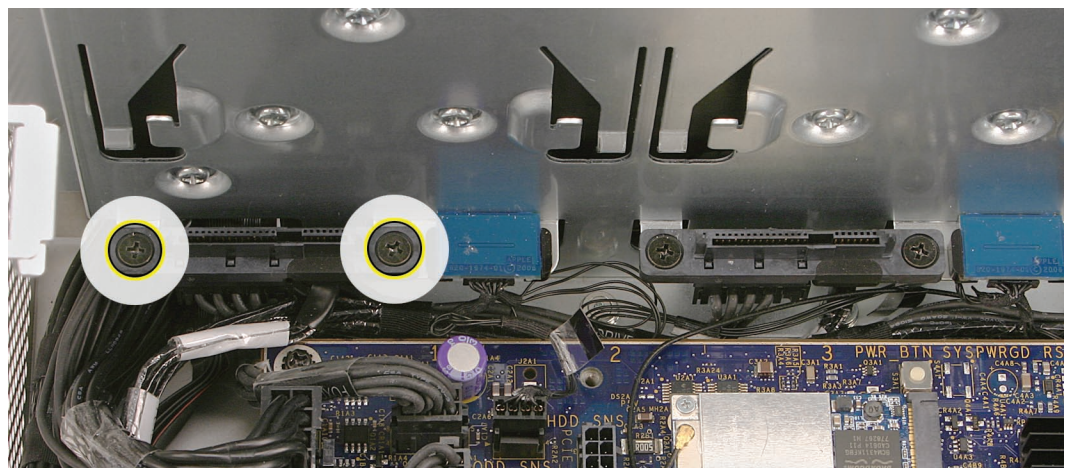

4. Route the ambient board cable out through the opening in the media shelf and remove the cable from the enclosure.

Important: After you replace the ambient board cable, you must reset the System Management Controller. Refer to [“Resetting the Logic Board”](#) in the Troubleshooting chapter.



Bluetooth Antenna Board and Cable

The Bluetooth antenna cable is part of the Bluetooth antenna board assembly. To remove or replace the cable, you must replace the antenna board assembly.

Tools

The only tool required for this procedure is a jeweler's flat-blade screwdriver.

Preliminary Steps

Before you begin, open the computer, lay it on its side with the access side facing up, and remove the following:

- [All hard drives and hard drive carriers](#)
- [All PCI Express cards](#)
- [Processor heatsink cover](#)
- [Front fan assembly](#)
- [Top and bottom memory cards with DIMMs](#)
- [Memory cage with rear fan](#)
- [Processor heatsinks](#)
- [Speaker assembly](#)
- [USB cable](#)
- [AirPort Extreme card \(if installed\)](#)
- [Bluetooth card \(if installed\)](#)
- [Logic board](#)

Part Location

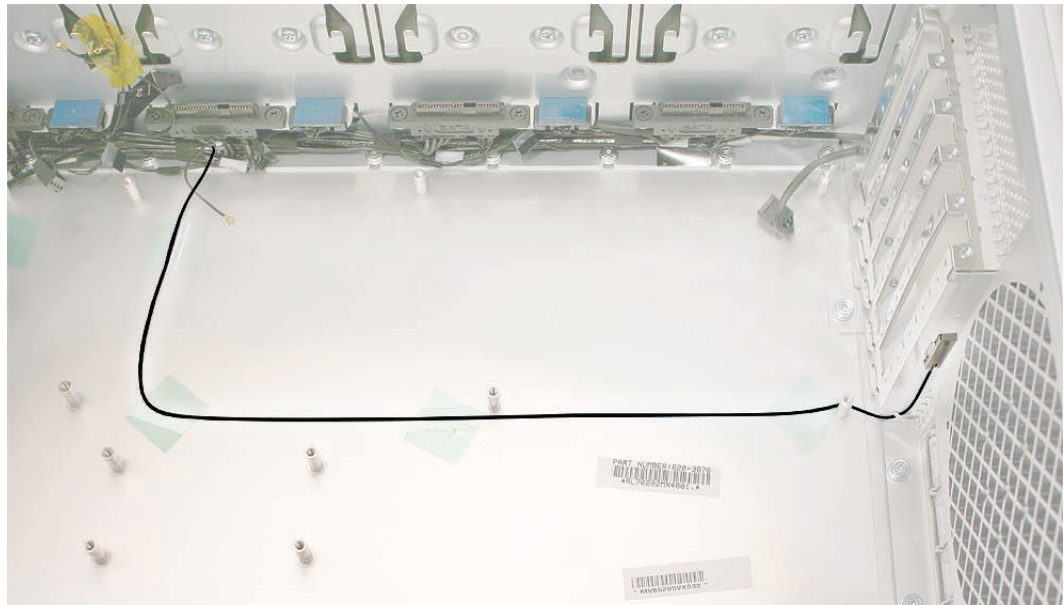

Procedure

1. Insert a jeweler's flat-blade screwdriver into the notch on either side of the Bluetooth antenna cage and carefully pry up the cage from the enclosure.



2. Remove the tape holding the Bluetooth antenna cable to the enclosure.

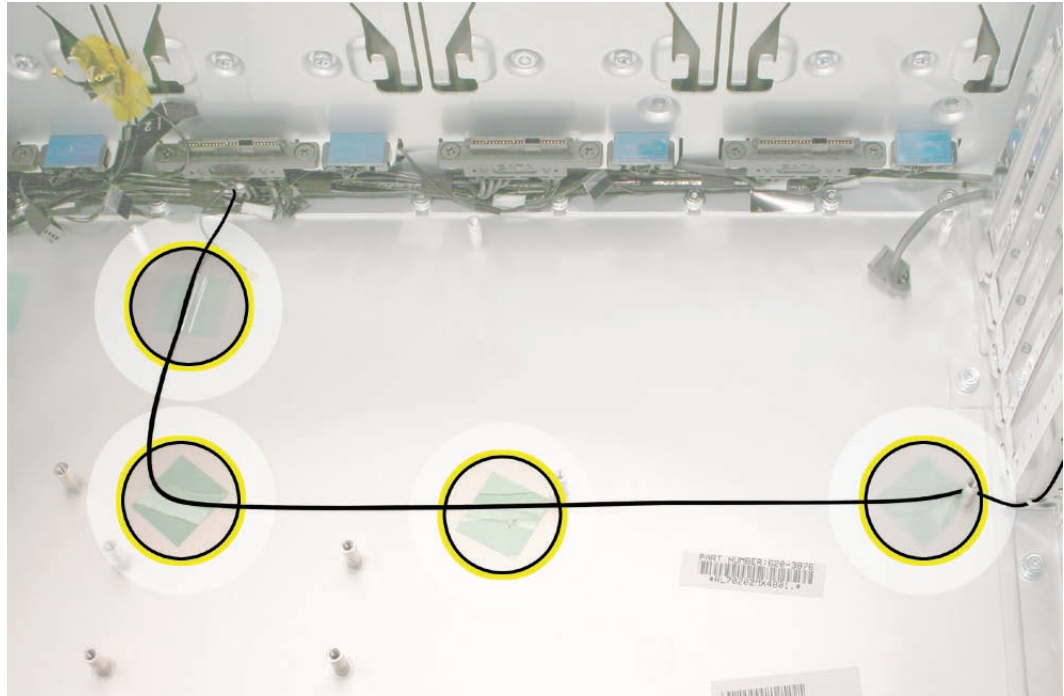

3. Remove the antenna board and antenna cable from the enclosure.



Hard Drive Cable Harness

The hard drive cable harness consists of the hard drive data cable and the hard drive power cable taped together. The cables are not available as separate service parts.

Tools

The only tools required for this procedure are a long-handled, magnetized #1 Phillips screwdriver.

Preliminary Steps

Before you begin, open the computer, lay it on its side with the access side facing up, and remove the following:

- [Hard drives and hard drive carriers in drive bays 1 and 2](#)
- [Any 12-inch PCI Express cards](#)
- [Processor heatsink cover](#)
- [Front fan assembly](#)

Part Location



Procedure

1. Disconnect the hard drive data and power cable connectors from the logic board.

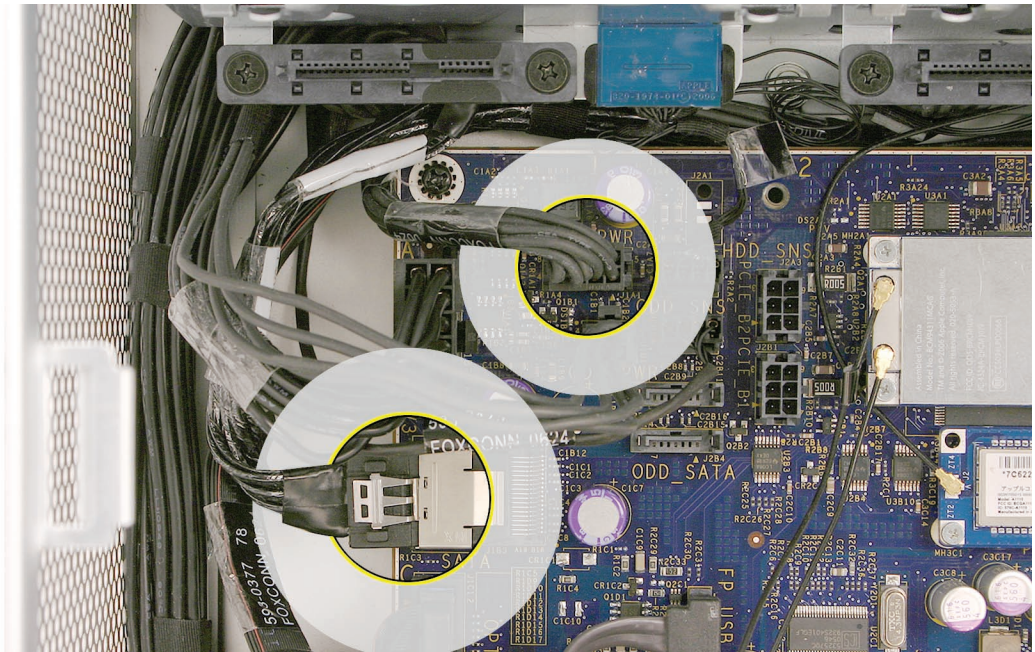

2. Using a long-handled, magnetized #1 Phillips screwdriver, remove the two screws holding the hard drive cable harness connector to the bracket below hard drive bay 1.
3. Remove the connector from the bracket.
4. Repeat for the other three connectors below hard drive bays 2, 3, and 4.

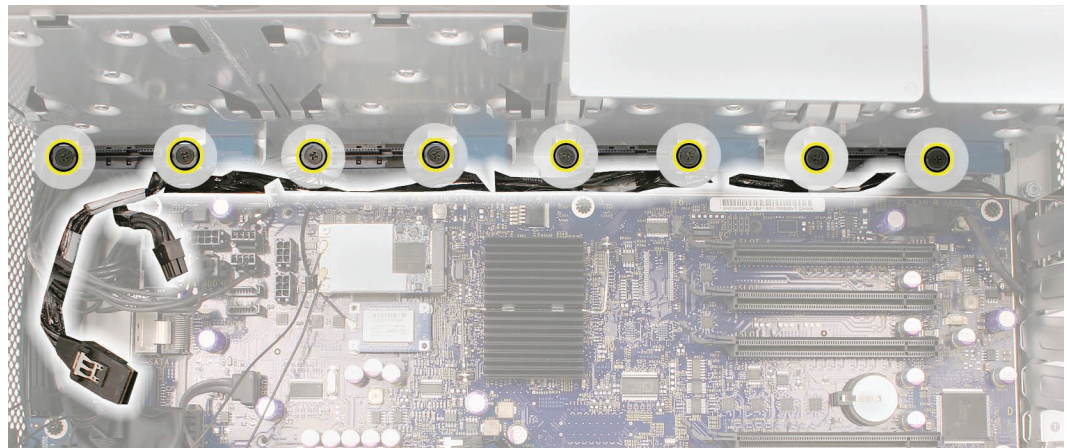

5. Remove the hard drive cable harness from the enclosure.



Hard Drive Temperature Sensor Cable

The hard drive temperature sensor cable is a wire harness with four connectors, one for each hard drive temperature sensor. Be careful not to catch or damage any of the wires when removing the harness from the enclosure.

Tools

No tools are required for this procedure.

Preliminary Steps

Before you begin, open the computer, lay it on its side with the access side facing up, and remove the following:

- [Hard drives and hard drive carriers in drive bays 1 and 2](#)
- [Any 12-inch PCI Express cards](#)
- [Processor heatsink cover](#)
- [Front fan assembly](#)

Part Location

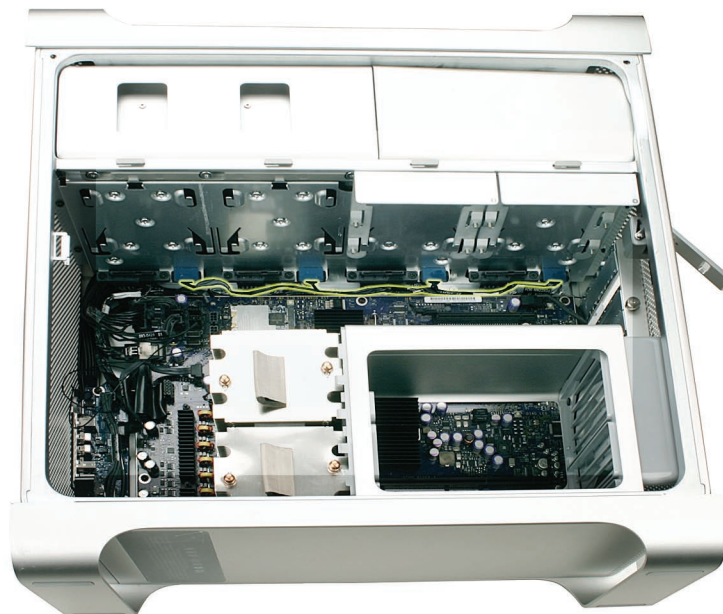

Procedure

1. Disconnect the hard drive temperature sensor cable from the logic board.
2. Disconnect the four connectors on the hard drive temperature sensor cable from the four hard drive temperature sensors.

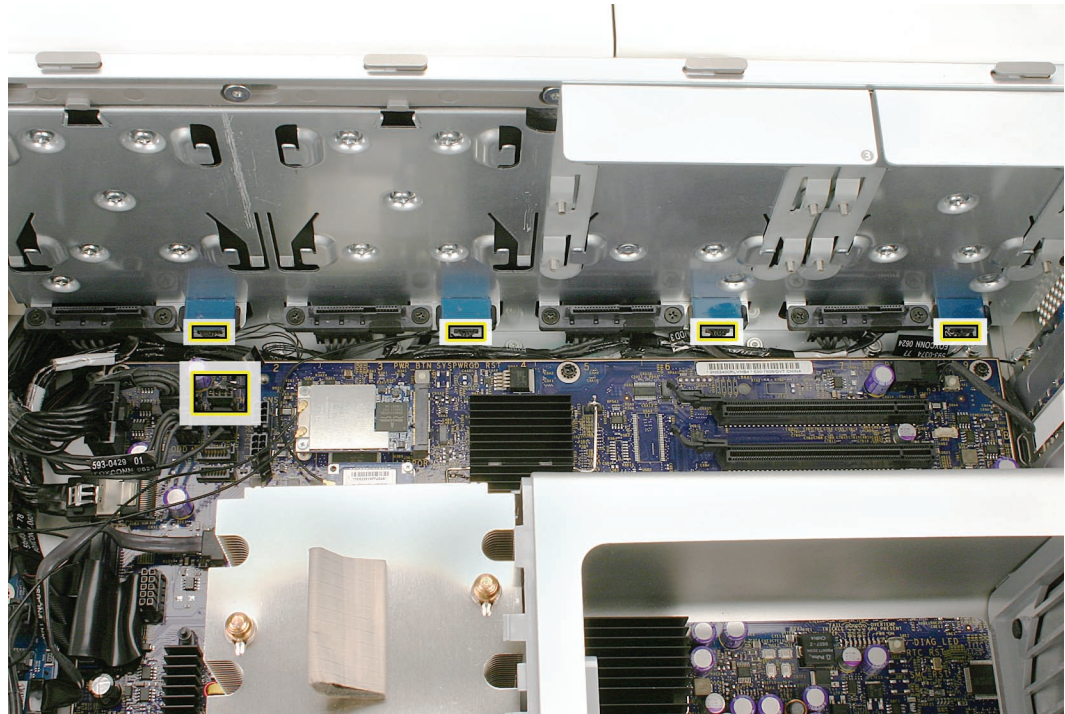

3. Remove the hard drive temperature sensor cable from the enclosure.

Replacement Note: The connectors on the hard drive temperature sensor cable are labeled with HDD1, HDD2, HDD3, and HDD4 to indicate the connector that belongs to each temperature sensor.



Hard Drive Temperature Sensor

There are four hard drive temperature sensors, one for each hard drive. This procedure explains how to remove the sensor for the hard drive in drive bay 1. The procedure for removing the other three sensors is similar, except that the only part you need to remove before beginning the procedure is the hard drive directly over the sensor.

Tools

The only tools required for this procedure are a mirror and a black stick or a flat-blade screwdriver.

Preliminary Steps

Before you begin, open the computer, lay it on its side with the access side facing up, and remove the following:

- [Hard drives and hard drive carriers in drive bays 1 and 2](#)
- [Any 12-inch PCI Express cards](#)
- [Processor heatsink cover](#)
- [Front fan assembly](#)

Part Location

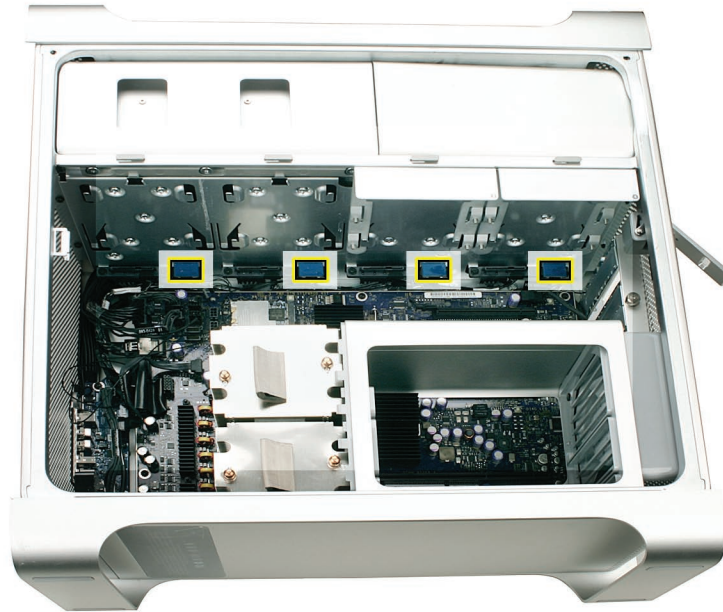

Procedure

1. Disconnect the sensor cable for the hard drive in bay 1 and move the cable out of the way.

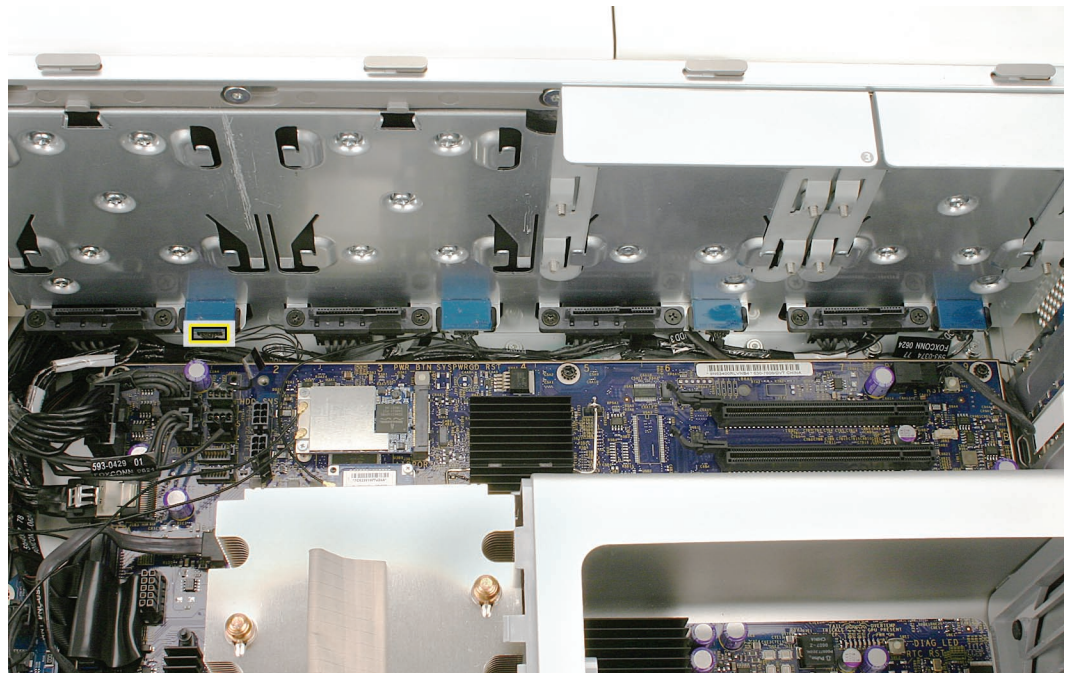

2. Using a mirror, locate the two round black nubs on the bottom of the hard drive sensor below hard drive bay 1.
3. Using a black stick or a flat-blade screwdriver, press up on the nubs and remove the sensor from the enclosure.

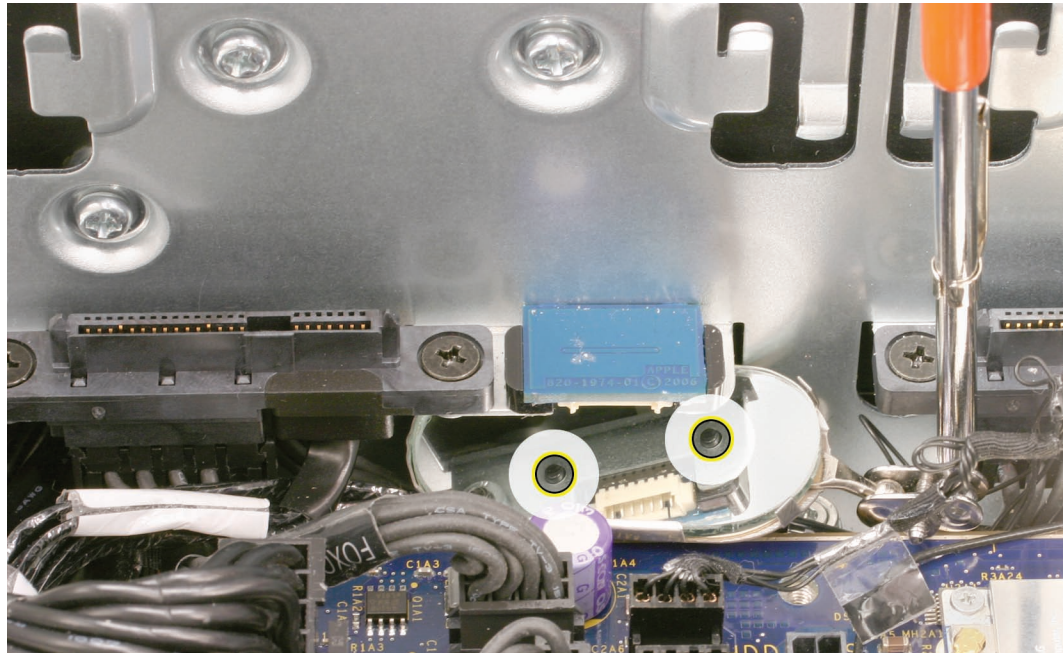



Power Cable Harness

The power cable harness consists of the following cables:

- Power supply PS1 cable
- Power supply PS2 cable
- Power supply PS3 cable
- Power supply PS4 control cable
- Front panel board power cable
- Front panel board audio cable
- Front panel board FireWire 800 cable

Tools

No tools are required for this procedure.

Preliminary Steps

Before you begin, open the computer, lay it on its side with the access side facing up, and remove the following:

- [Optical drive carrier and optical drives](#)
- [Hard drives and hard drive carriers in drive bays 1 and 2](#)
- [PCI Express card installed in slot 1](#)
- [Any 12-inch PCI Express cards](#)
- [Processor heatsink cover](#)
- [Front fan assembly](#)
- [Top and bottom memory cards with DIMMs](#)
- [Memory cage with rear fan](#)
- [Optical drive power cable](#)
- [Optical drive data cable](#)
- [Front panel board](#)

Part Location



Procedure

1. Disconnect the power cable harness connectors from the logic board.

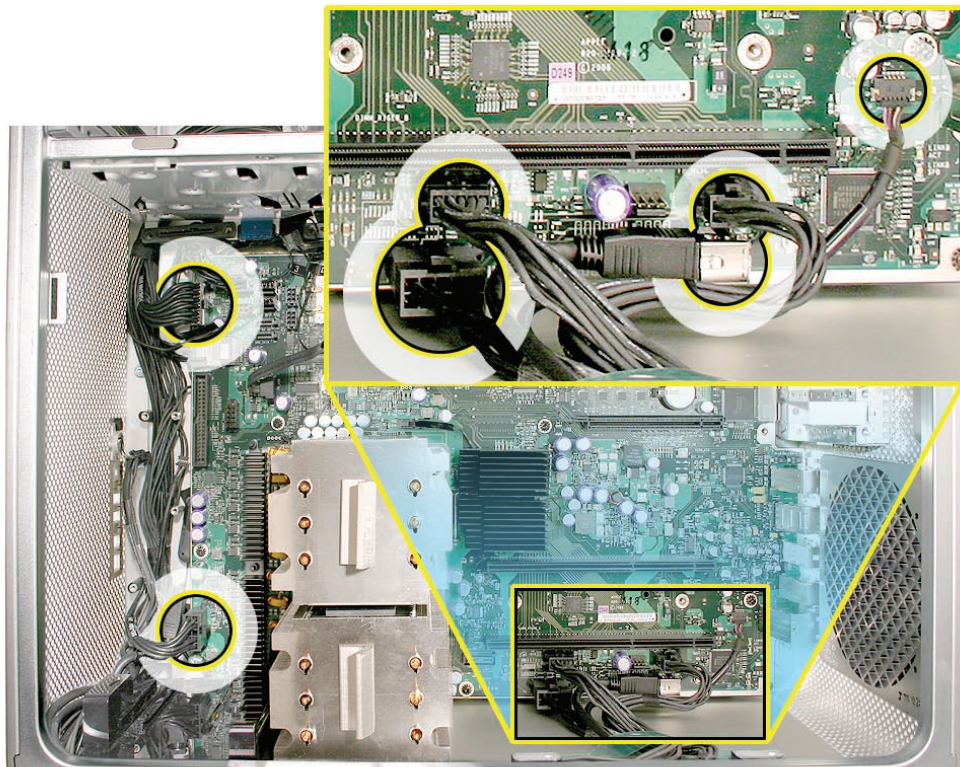

- Using a Phillips screwdriver, remove the two mounting screws on the power supply cable cover located at the back of the optical drive bay.



- Slide the cover toward the top of the enclosure, tilt it up until the two tabs on the cover clear the slots in the media shelf, and remove the cover from the enclosure.

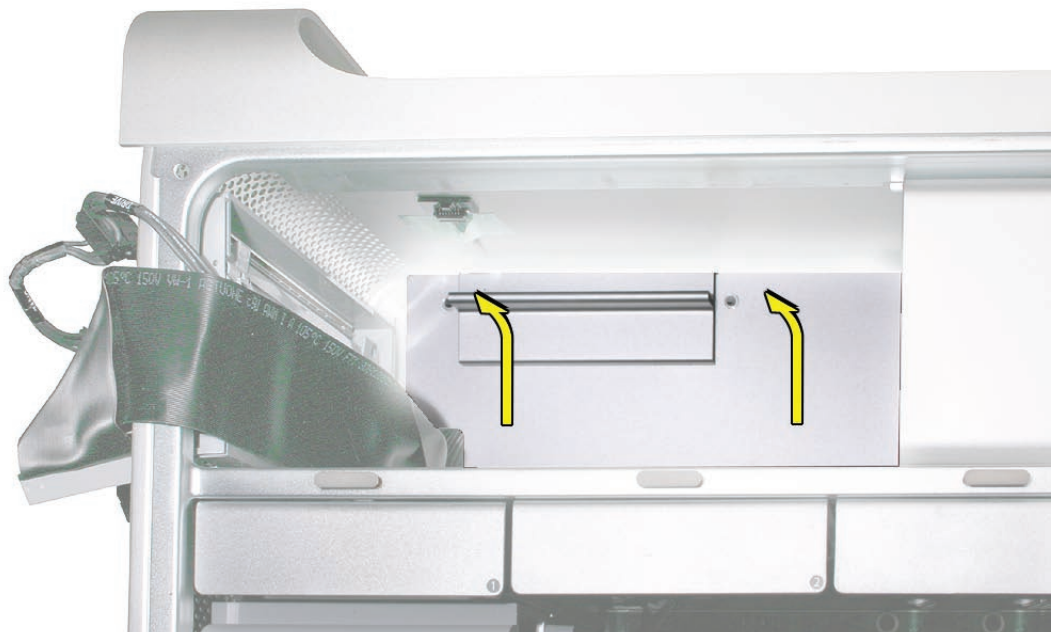

Replacement Note: Replace the cover at an angle so that the tabs engage with the slots in the media shelf. Then lower the cover into place.

4. Release the four power supply cables from their hook-and-loop fasteners on the enclosure.
5. Depress the locking latch on each cable connector and disconnect the four power supply cables from the four connectors on the power harness cable.

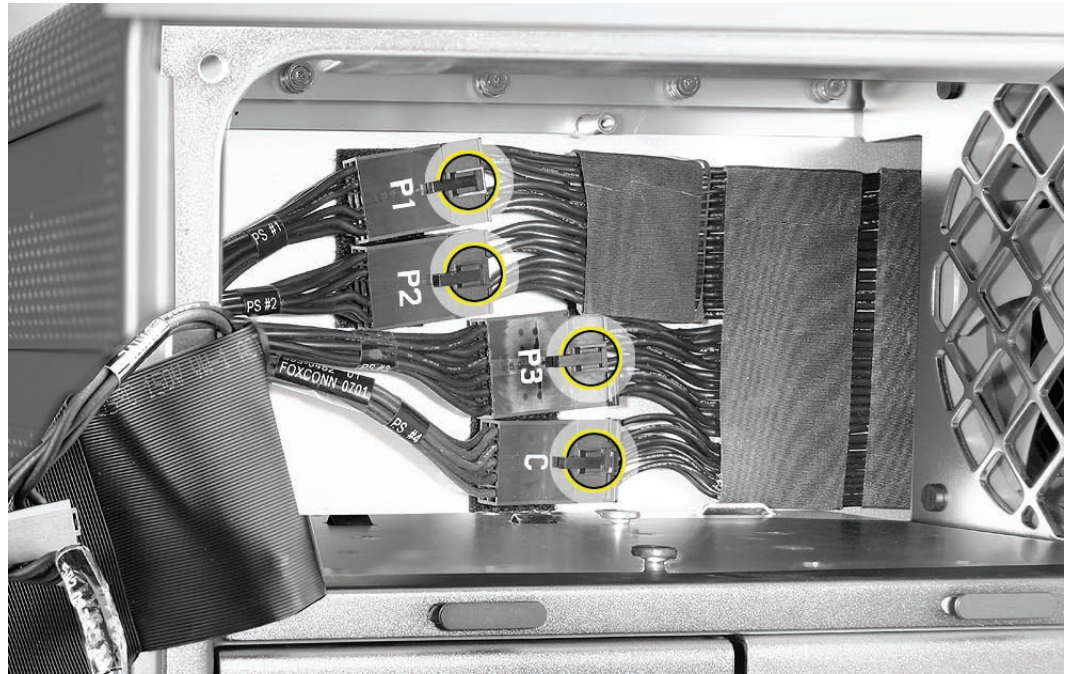

6. Slip the four connectors out through the opening in the media shelf, removing them one at a time.

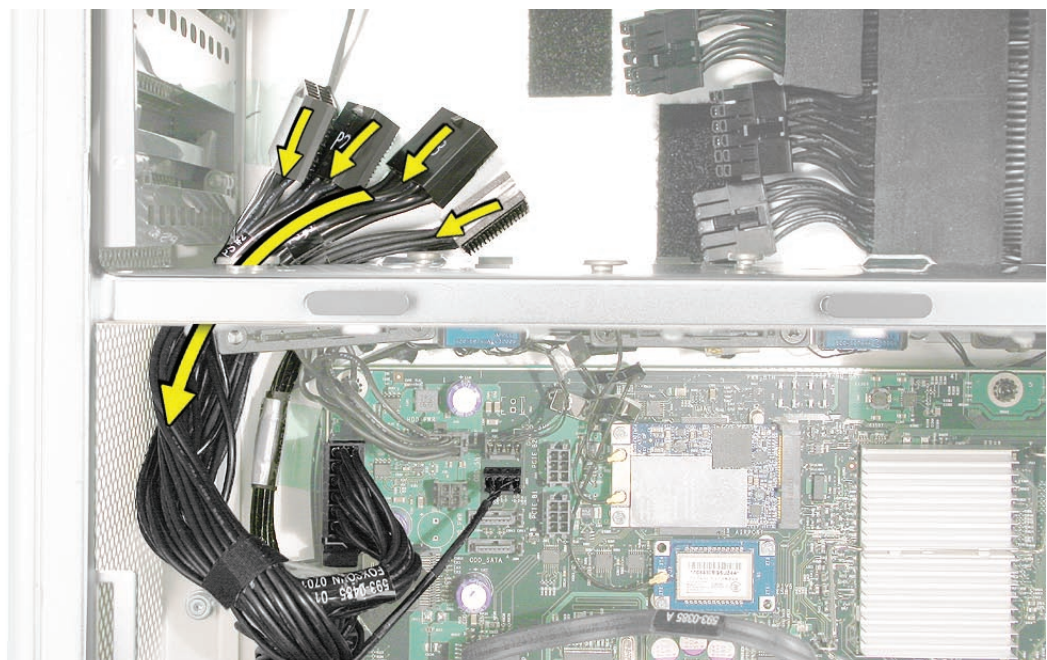

7. Untape the power harness cable from the enclosure.
8. Remove the power harness cable from its routing along the edge of the logic board, over the speaker assembly, and along the bottom lip of the enclosure.

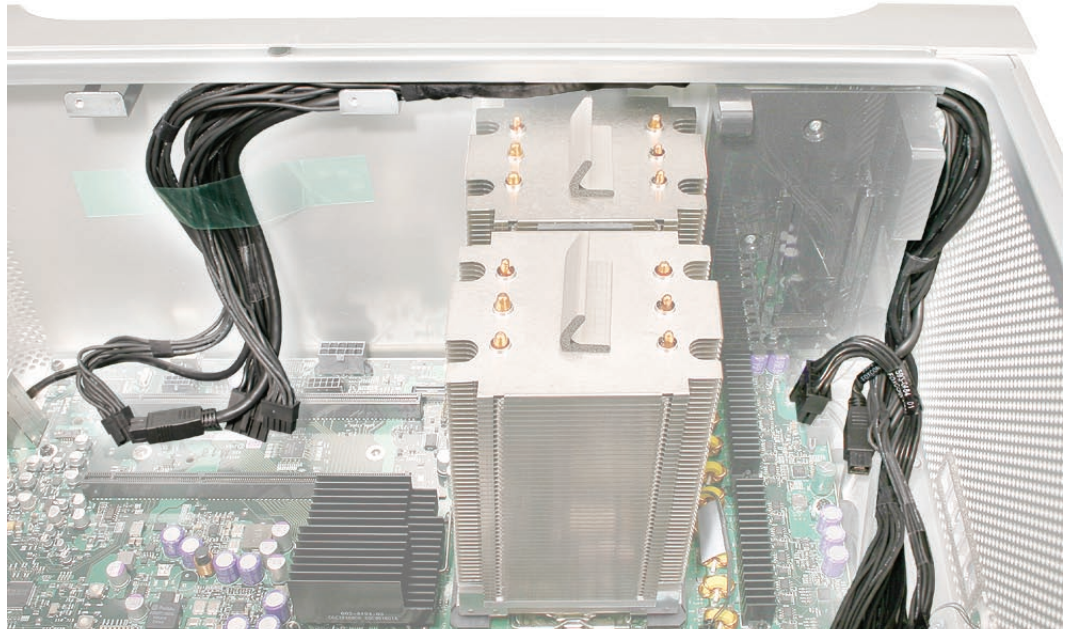

9. Remove the power harness cable from the enclosure.



Troubleshooting
Mac Pro (8x)



General Information

Memory

The Mac Pro (8x) computer has two memory cards with a total of 8 memory slots. On each card, the slots are arranged as two banks of two slots each. The computer comes with a minimum of 1 GB of memory, installed as a pair of 512 MB fully buffered, dual inline memory modules (FB-DIMMs) in two of the DIMM slots. Additional DIMMs can be installed in the open DIMM slots, as illustrated below.

Note: DIMMs must be installed in pairs of equal size from the same vendor. In the following illustration, DIMMs in one colored pair do not need to match DIMMs in a different colored pair.



Memory Configuration	Riser A: Top Riser	Riser B: Bottom Riser
2 DIMMs Gold fingers	DIMM1 DIMM2 DIMM3 DIMM4	DIMM1 DIMM2 DIMM3 DIMM4
4 DIMMs	DIMM1 DIMM2 DIMM3 DIMM4	DIMM1 DIMM2 DIMM3 DIMM4
6 DIMMs	DIMM1 DIMM2 DIMM3 DIMM4	DIMM1 DIMM2 DIMM3 DIMM4
8 DIMMs	DIMM1 DIMM2 DIMM3 DIMM4	DIMM1 DIMM2 DIMM3 DIMM4

DIMMs for Mac Pro (8x) must fit these specifications:

- 667 MHz, FB-DIMMs
- 72-bit wide, 240-pin modules
- 36 devices maximum per DIMM
- Error-correcting code (ECC)

Important: For proper operation of Mac Pro (8x) computers, Apple recommends using only Apple-approved Mac Pro (8x) FB-DIMMs. Refer to GSX for Apple FB-DIMMs service part numbers.

PCI Express Cards

The Mac Pro (8x) logic board includes one double-wide PCI Express graphics slot and three PCI Express expansion slots, for a total of four slots. The computer comes with a graphics card installed in slot 1. You can install additional PCI Express graphics and expansion cards in the remaining three PCI Express expansion slots.

Important: Combined maximum power consumption for all four PCI Express slots must not exceed 300 W.

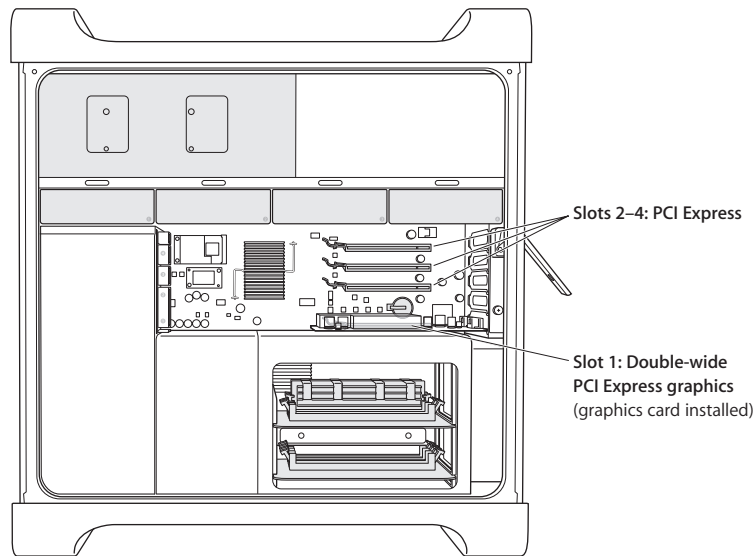

Internal Cabling Matrix

The table on the next page lists all Mac Pro (8x) internal cables that connect to the logic board and are not part of a larger subassembly. Following the table is a map of the logic board connector locations, which are listed in column 5 of the table.

Cable, Connector and Signal Matrix		LENGT H (mm)	LENGT H (in)	MLB CONN LOCATION	MLB CONN LABEL	MLB CONN DESCRIPTION	CONNECTOR 2 DESCRIPTION	CONNECTOR 3 DESCRIPTION	CONNECTOR 4 DESCRIPTION	CONNECTOR 5 DESCRIPTION	POWER / SIGNALS CARRIED
HDD SATA	Part of 922-7682	450	17.7	C-1	SATA	36-pin high-density	7-pin flat to HDD 1	7-pin flat to HDD 2	7-pin flat to HDD 3	7-pin flat to HDD 4	Serial ATA signals to/from all four HDDs and main logic board
HDD Power	Part of 922-7682	442	17.4	A-1	HDD_PWR	8-pin (2X4)	15-pin flat to HDD 1	15-pin flat to HDD 2	15-pin flat to HDD 3	15-pin flat to HDD 4	DC power to all four HDDs from main logic board
HDD Thermal Sensor	922-7730	610	24.0	A-2	HDD_SNS	4-pin flat (4X1)	7-pin flat to sensor bd underneath HDD 1	7-pin flat to sensor bd underneath HDD 2	7-pin flat to sensor bd underneath HDD 3	7-pin flat to sensor bd underneath HDD 4	Thermal sensor signals from sensors in all HDD bays to main logic board
Optical Drive Power	922-7684	559	22.0	B-1	ODD_PWR	4-pin square (4x1)	standard 4-pin (4x1) to upper ODD	standard 4-pin (4x1) to lower ODD			DC power to both optical drives from main logic board
Optical Drive IDE	922-7686	586	23.1	D-1	OPTICAL	40-pin standard IDE (20X2)	Standard 40-pin IDE for lower ODD	Standard 40-pin IDE for upper ODD			IDE signals to/from all optical drives and main logic board
Power Supply PS #1	922-8059	1033	40.7	K-6	none	Large 10-pin (5X2)	Large 10-pin (5x2) from PS labeled PS#1				DC power to main logic board from power supply
Power Supply PS #2	922-8060	469	18.5	J-1	none	Large 10-pin (5X2)	Large 10-pin (5x2) from PS labeled PS#2				DC power to main logic board from power supply
Power Supply PS #3	922-8061	273	10.7	B-1	none	Large 12-pin (6X2)	Large 12-pin (6x2) from PS labeled PS#3				DC power to main logic board from power supply
Power Supply Control PS #4	922-8030	1083	42.6	K-6	none	Medium 10-pin (5X2)	Large 10-pin (5x2) from PS labeled PS#4				Power supply control signals to/from main logic board
Front Panel Board Power	922-7690	860	33.9	K-7	FP_MISC	Medium 8-pin (4X2)	Medium 8-pin (4x2) on top of FP bd				Power, power LED, power button, and control signals to the front panel board from the main logic board
Front Panel Board Audio	922-7692	865	34.1	J-9	FP_AUDIO	Small sideways 5-pin (5X1)	Small sideways 5-pin on top of FP bd				Audio signals to the front panel board from the main logic board
Front Panel Board FireWire-800	922-7691	695	27.4	K-7	FP_FWB	9-pin sideways standard FW800	9-pin sideways standard FW800 on bottom of FP bd				Standard FW800 9-pin to 9-pin cable to front panel board from main logic board
Front Panel Board USB	922-7693	150	5.9	C-2	FP_USB	Small 7-pin rt angle (7X1)	Small 7-pin rt angle in middle of FP bd				USB 2.0 power and data to front panel board from main logic board
Intake Ambient Temperature Sensor	922-7731	400	15.7	B-2	ODD_SNS	Small 4-pin (4X1)	Small 7-pin on thermal sensor bd inside top of ODD bay				Thermal sensor signals from ODD bay ambient temp sensor to main logic board

Cable Connector Locations

Use the diagram below to find the location of the internal cable connectors on the logic board.

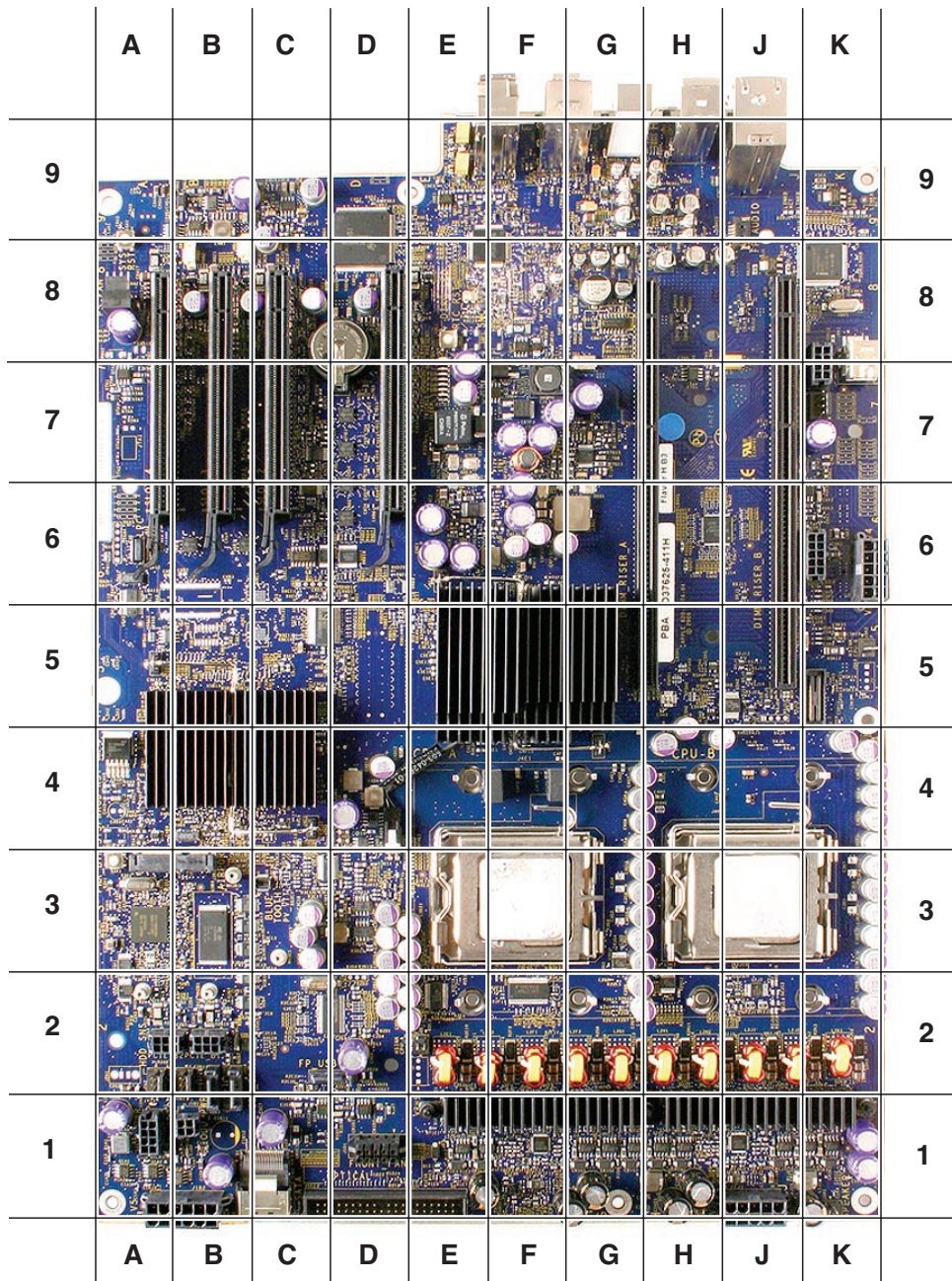

Thermal Calibration

Unlike in earlier Power Mac G5 computers, replacing a processor in a Mac Pro (8x) computer does not require running Apple Service Diagnostic for thermal calibration.

Resetting the Logic Board

System Management Controller (SMC) Reset

The System Management Controller (SMC) is a chip on the logic board that controls all power functions for the computer. If the computer is experiencing any power issue, resetting the SMC may resolve it. The SMC controls several functions, including:

- Telling the computer when to turn on, turn off, sleep, wake, idle, and so forth
- Handling system resets from various commands
- Controlling the fans

It is also recommended that the SMC be reset after a logic board, ambient board, or ambient board cable is replaced as part of a repair.

Note that resetting the SMC does not reset the PRAM. Resetting the SMC will not resolve issues in which the computer is unresponsive—in these situations, restarting the computer will generally suffice. If the computer isn't responding, perform these steps one at a time, in the following order, until the issue has been resolved:

1. Force Quit (Option-Command-Escape)
2. Restart (Control-Command-Power)
3. Force Shut Down (press the power button for 10 seconds)

Resetting the SMC can resolve some computer issues such as not starting up, not displaying video, sleep issues, fan noise issues, and so forth. If the computer still exhibits these types of issues after you've restarted the computer, try resetting the SMC. There are two ways to reset the SMC on Mac Pro (8x).

You can use the SMC reset switch:

1. From the Apple menu, choose Shut Down (or if the computer is not responding, hold the power button until it turns off).
2. Press the SMC_RST switch, which is located to the right and slightly below the row of diagnostic LEDs. (See the [LED diagram](#) in the following "Diagnostic LEDs" section.) To press the switch, use the nylon probe tool (Apple part number 922-5065).
3. Press the power button to start up the computer.

Or, you can reset the SMC by removing AC power:

1. From the Apple menu, choose Shut Down (or if the computer is not responding, hold the power button until it turns off).
2. Unplug the AC power cord.
3. Wait at least 15 seconds.
4. Plug the power cord back in, making sure the power button is not being pressed at the time.
5. Press the power button to start up the computer.

Real Time Clock (RTC) Reset

The Real Time Clock (RTC) is a chip on the logic board that controls the date and time functions of the computer. If the computer is experiencing an issue booting, resetting the RTC may resolve it. Follow these steps to reset the RTC:

1. From the Apple menu, choose Shut Down (or if the computer is not responding, hold the power button until it turns off).
2. Unplug the AC power cord.
3. Remove the battery for at least 20 seconds. You may need to remove a PCI Express card to have access to the battery.

System Reset

Mac Pro (8x) has a system reset switch on the logic board that may be used to restart the system while it is powered up. This switch can be used to determine if a computer that won't consistently boot from a cold start has power supply issues. Follow these steps to reset the system:

1. With the computer powered up, press the SYS_RST switch located in the upper right-hand corner of the logic board. To press the switch, use the nylon probe tool (Apple part number 922-5065).
2. If the computer boots after you press the SYS_RST switch, try shutting the computer off and restarting by pressing the front power button. If the computer restarts when you press the SYS_RST switch but not from a cold start, the power supply may need to be replaced.

Power-On Self Test: RAM and Processor Verification

A power-on self test in the computer's ROM automatically runs whenever the computer is started up after being fully shut down (the test does not run if the computer is only restarted). If the test detects a problem, the status LED located above the power button on the front of the computer will flash in the following ways*:

- 1 Flash: No RAM is installed or detected. Or, the quick memory test failed. An LED will light up on the memory riser card next to the affected DIMM or empty DIMM slot.
- 3 Flashes: A RAM bank failed extended memory testing. An LED will light up on the memory riser card corresponding to the affected DIMM.

Troubleshooting: Try reseating the memory DIMMs. Check memory installation instructions for proper installation order. Swap affected DIMM with known good DIMM.

***Note:** The status LED lights up when the power button is depressed at startup. Do not count this light as one of the diagnostic flashes. The memory riser card diagnostic LEDs will also flash briefly when the computer is started up or shut down and when it goes in and out of sleep mode. This is normal behavior.

Diagnostic LEDs

The Mac Pro (8x) logic board includes a set of LEDs to help service providers troubleshoot the computer. The LEDs are located toward the rear of the logic board, under the memory cage, next to PCI card slot 1. You can view these LEDs by removing the computer's side access panel and looking through the memory cage to the logic board below. LEDs 2, 3, 4, and 5 are normally off and will automatically illuminate if an error occurs. To read LEDs 1, 6, 7, and 8, you must press the DIAG_LED button, which is adjacent to the LEDs. To press the DIAG_LED button, use the nylon probe tool (Apple part number 922-5065).

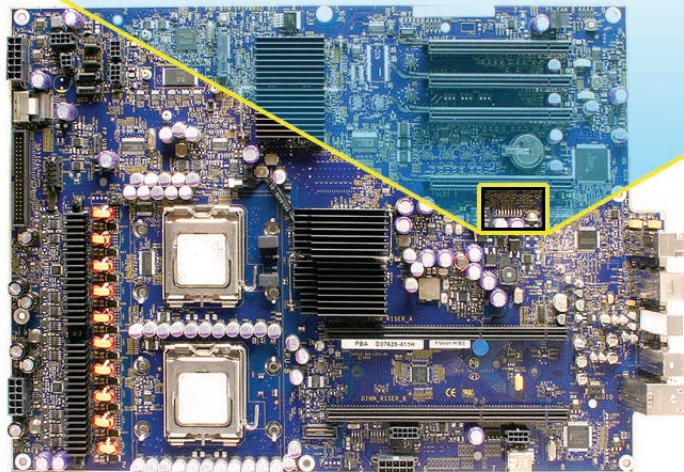
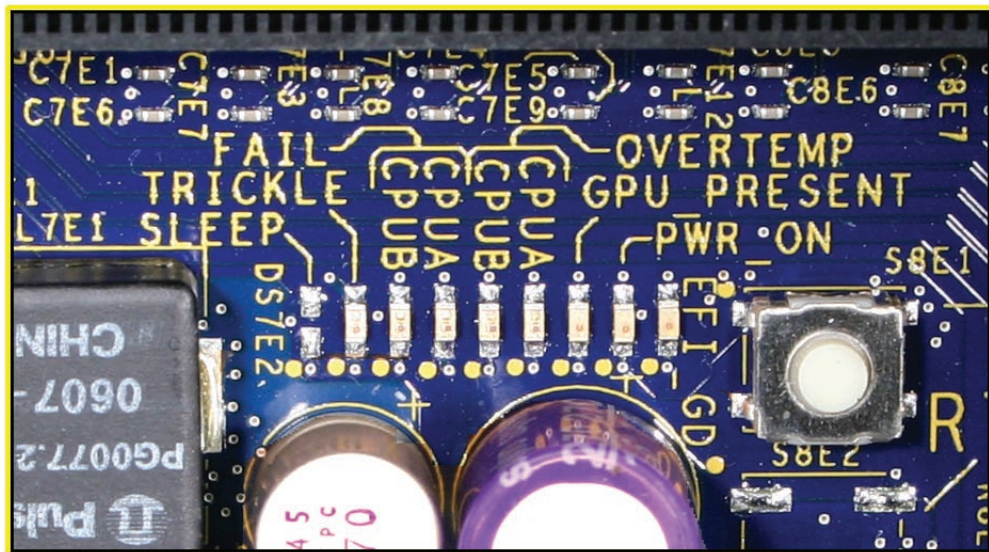

Use the following table to interpret the LEDs.

Location	Name	Color	Nominal	Press DIAG_LED button to display	Indicates
Led 1	Trickle Pwr	Yellow	On	Yes	Power supply is providing trickle power
Led 2	CPU B Error	Red	Off	No	CPU B halts on an IERR (instruction error)
Led 3	CPU A Error	Red	Off	No	CPU A halts on an IERR (instruction error)
Led 4	CPU B OT	Red	Off	No	CPU B is over temperature
Led 5	CPU A OT	Red	Off	No	CPU A is over temperature
Led 6	GPU Present	Green	On	Yes	EFI has configured the graphics card
Led 7	Power On	Green	On	Yes	All power rails are functioning
Led 8	EFI Done	Green	On	Yes	EFI is done loading

Note: There is a position on the logic board next to LED 1 for a SLEEP LED that does not have any LED installed. This is normal; the LED was used only in development. To determine if a Mac Pro (8x) computer is in sleep mode, watch the power LED on the front of the computer. It will slowly change brightness levels if the computer is sleeping.

LED 1 Trickle Power

Normally on when DIAG_LED button is pressed.

If LED 1 is not on, the symptom would be that the computer won't power on.

Troubleshooting:

- Check AC cord is connected to a working AC wall outlet.
- Reseat AC Plug.
- Check connections of power supply cables to the logic board.
- Check power supply cable connections at power supply.
- Replace power supply.

LED 2 CPU B (Lower Processor) Error
LED 3 CPU A (Upper Processor) Error

Normally off. These LEDs come on if an error occurs or if the BootROM is corrupted. They do not depend on the DIAG_LED button being pressed.

Related symptoms include no video or the computer is hung up. If the BootROM is corrupted, the optical drive tray should eject, prompting for the insertion of a recovery disc to restore the BootROM.

Troubleshooting:

- With the computer booted, up press the SYS_RST switch. If this clears the CPU Error LED, check for incompatible device driver software that may have been installed for added hardware.
- If the Error LED is still on, power down the computer and try pressing the SMC_RST switch. Restart the computer.
- Reset the power supply by unplugging the AC cord for 10 seconds.
- Unplug AC cord and remove any added DIMMs and PCI Express cards. If this causes the LED to go off, repopulate the DIMMs and/or PCI Express cards to find the combination that caused the LED to come on. Overheated memory could be a possible cause for this CPU error LED to come on. Check fan operation.
- Unplug the AC cord and remove the battery for 10 seconds. You may need to remove a PCI Express card to get to the battery. Reinstall the battery and restart the computer.
- Try swapping CPU A and CPU B locations. If the CPU Error LED follows the CPU, replace that CPU.
- Try replacing the logic board.

LED 4 CPU B (Lower Processor) Overtemp
LED 5 CPU A (Upper Processor) Overtemp

Normally off. These LEDs come on if an error occurs. They do not depend on the DIAG_LED button being pressed.

These two LEDs can operate in two different modes; they will either flash or stay on. If either LED is flashing, it may indicate an initial processor over-temperature condition. If either LED is solidly on, it may indicate a chronic processor over-temperature condition. Initial processor over-temperature can cause symptoms such as sluggish computer performance. Chronic processor over-temperature can cause the computer to hang completely.

Troubleshooting:

- Verify proper heatsink installation.
- Verify all thermal sensors are properly connected.
- Verify all fans are operating properly, especially the front intake fan.
- Verify power supply cables are properly seated.
- If both overtemp LEDs come on immediately when the computer is turned on, a faulty power supply could be one cause of this behavior. Replace power supply.
- Try swapping CPU A and CPU B heatsink locations. If the CPU Error LED follows the CPU heatsink, replace that CPU heatsink.

-
- Try swapping CPU A and CPU B locations. If the CPU Error LED follows the CPU, replace that CPU.

LED 6 GPU Present

Normally on when DIAG_LED button is pressed.

If this LED is on, it indicates there is a graphics card installed and recognized by the computer. It does not indicate that the graphics card is fully functional. Some graphics cards require additional power to function, which is available from connectors on the logic board. For these cards, if the auxiliary booster power cable is not connected between the logic board and the graphics card, an error message reminding about this additional power connection will be displayed as Mac OS X starts up.

Troubleshooting:

- Check that the graphics card is seated correctly in its PCI slot.
- Check that the card's auxiliary booster power cable is connected properly on both ends (if the card requires one). If the cable is connected properly, try connecting it to the other, empty logic board booster power connector (if available) to see if the cause is related to this connector. If the card and LED operate properly when connected to the other power connector, check EFI and SMC firmware versions and update them if necessary. See "[Mac Pro Firmware Updates](#)" in this section for more information. Only then should you consider replacing the logic board.
- Verify power supply cables are properly seated.
- Try the graphics card in a different PCI slot.
- Try a different graphics card.
- If an error message about graphic card booster power connection is displayed, check that the appropriate booster power cable is firmly connected between the logic board and the graphics card.
- Replace the logic board.

LED 7 Power On

Normally on when DIAG_LED button is pressed.

If this LED is on, it indicates the power supply is functioning.

Troubleshooting:

- Check that the power cables to the logic board are properly attached.
- Check the cable connections at the power supply.
- Check for any signs of an obvious electrical short, e.g. metal screws or PCI card slot cover loose inside computer touching the logic board.

LED 8 EFI Good

Normally on when DIAG_LED button is pressed. Takes approximately 5 seconds after power up.

If this LED is on, it indicates that the computer has completed the on board Extensible Firmware

Interface (EFI) operations and the operating system is now in control.

Troubleshooting:

- Check that LED 7 Power On LED is on.
- Check that LEDs 2, 3, 4, and 5 are off.
- Try removing any added hardware.
- Try removing any added DIMMs.

Memory Riser Card Diagnostic LEDs

Both of the memory riser cards include diagnostic LEDs for each DIMM. Each of the LEDs will light if it detects an issue with the corresponding installed DIMM. These LEDs will also flash briefly when the computer is started up or shut down and when it goes in and out of sleep mode. This is normal behavior.

Troubleshooting:

- Shutdown and restart the computer.
- Verify EFI and SMC firmware versions and update them if necessary. See [“Mac Pro Firmware Updates”](#) in this section for more information.
- Reseat the memory riser card associated with the failure LED. If the failure LED persists, continue with the next step.
- Swap upper and lower memory riser cards A and B. If the symptoms follow the riser card, continue with the next step. If the failure LED remains associated with the same memory riser card slot, consider a possible connection issue with the logic board. Replace the logic board in this case.
- Reseat the appropriate DIMM corresponding to the failure LED. If the issue persists, continue with the next step.
- Check memory installation instructions for proper installation order.
- Swap affected DIMM with known good DIMM.
- Try moving DIMM to another slot (within the same bank of two) to see if the failure LED follows the DIMM. If so, replace DIMM with known good DIMM. If the failure LED persists, replace the memory riser card associated with the failure LED.

Video Card Diagnostic LEDs

T_Fault LED

Normally off, this LED lights up if the graphics chip gets too hot.

Troubleshooting:

- Verify that the video card heatsink and fan are not clogged with dust. Carefully blow out any dust as necessary.
- Check that the front fan is working.
- Try re-seating the card in the PCI Slot.
- Make sure the card’s auxiliary booster power cable is connected (if there is one).
- Re-boot the computer.
- Try a different video card.

-
- Replace the video card.

Ext_Power LED

Normally off, this LED lights up if the auxiliary power isn't being supplied.

Troubleshooting:

- Make sure the card's auxiliary booster power cable is connected (if there is one).
- Check connections from the power supply to the logic board.
- Try a different auxiliary power cable.
- Try a different video card.
- Replace the video card.

Power Supply Verification

To power on, the computer's logic board requires "trickle" power. If the system fails to power on, first reset the SMC as described in this chapter. If the computer still doesn't power on, follow the procedure outlined below to determine whether the issue is related to the power supply.

Verify trickle power

Diagnostic LED 1 indicates the presence of trickle power required by the logic board to begin the startup process.

LED 1 should be yellow when the DIAG_ LED button is pressed, indicating that trickle voltage is present.

Verify Power Supply Is Providing Power

Diagnostic LED 7 indicates that the main power is OK and within regulation.

Plug in AC power cord, and press the power-on button on the front panel.

LED 7 should be green when the DIAG_ LED button is pressed, indicating that the main power is OK and within regulation.

If diagnostic LED 4 and LED 5 are both solidly illuminated at power up, improperly seated power supply cables could be one cause of this behavior. Check all power supply cable connections to ensure they are properly seated.

Mac Pro Firmware Updates

Firmware is the name given to software that is written into memory circuits, such as flash memory, that will hold the software code indefinitely, even when power is removed from the hardware. Firmware on Intel Mac computers is designed to be updated if necessary through a software update.

EFI and SMC firmware is stored on the Mac Pro (8x) logic board. EFI firmware updates update

the Boot ROM, and SMC updates update the System Management Controller firmware. The SMC manages fans and other environmental parameters that are independent of the Boot ROM.

Firmware symptoms can be easily mistaken for hardware issues (e.g., overheating issues, fan noise issues, etc.). Always check both EFI and SMC firmware versions and update if necessary before replacing any hardware components in the Mac Pro (8x).

The following lists describe the type of symptoms that may be resolved by updating the EFI and SMC firmware in the Mac Pro (8x).

Symptoms that may be resolved by updating EFI firmware:

- Cannot eject media (various conditions)
- No video on start up
- Blue system failure screens in Windows XP/Vista
- Not waking or sleeping when expected
- Bad media taking too long to eject (including holding mouse button down at startup taking minutes to eject)

Symptoms that may be resolved by updating SMC firmware:

- Fan related behavior (excessive speed or noise)
- Loud audible clicking from some fans
- Thermal shut down or warnings
- Diagnostics reporting failures
- Sleep/wake issues
- Intermittent shut down
- SMC causes bad/missing ambient sensor to cause the computer to go to sleep
- Hangs, black screen on restart from Windows
- Quick power cycle causes Memory Riser Card Diagnostic LEDs & CPU Overtemp LEDs to illuminate solidly
- Unit does not restart after changing configuration in Expansion Slot Utility

Please follow the steps outlined in KnowledgeBase article 303364, "[About Firmware Updates for Intel-based Macs](#)," to perform an EFI and/or SMC firmware update. Information about firmware versions for Intel Macs can be found in KnowledgeBase article 303880, "[Mac OS X: Firmware Updates for Intel-based Macs](#)."

Processor Heatsink and Processor Visual Inspection Instructions

The Mac Pro (8x) uses a special coating on the processor heatsink and processor to manage the temperature in the computer. Before installing a new or existing heatsink or processor, always make a visual inspection of the part. Specifically, check the application of the silver-colored coating on the underside of the heatsink and the top of the processor. In addition, check the condition of the gasket that surrounds the coating on the heatsink.

Important: When inspecting the special coating, wear disposable nitrile or latex gloves and avoid touching the coating.

Silver-Colored Coating on Heatsink and Processor

Use the following guidelines to determine if the silver-colored coating on the underside of the heatsink and the top of the processor is correctly applied. If a new, replacement heatsink or processor fails to meet the prescribed standards, return it to Apple. If an existing heatsink or processor fails the standards, replace it with a new part before installing it in the computer.

Acceptable standard

The silver-colored coating should be applied in a smooth, even square as show below.

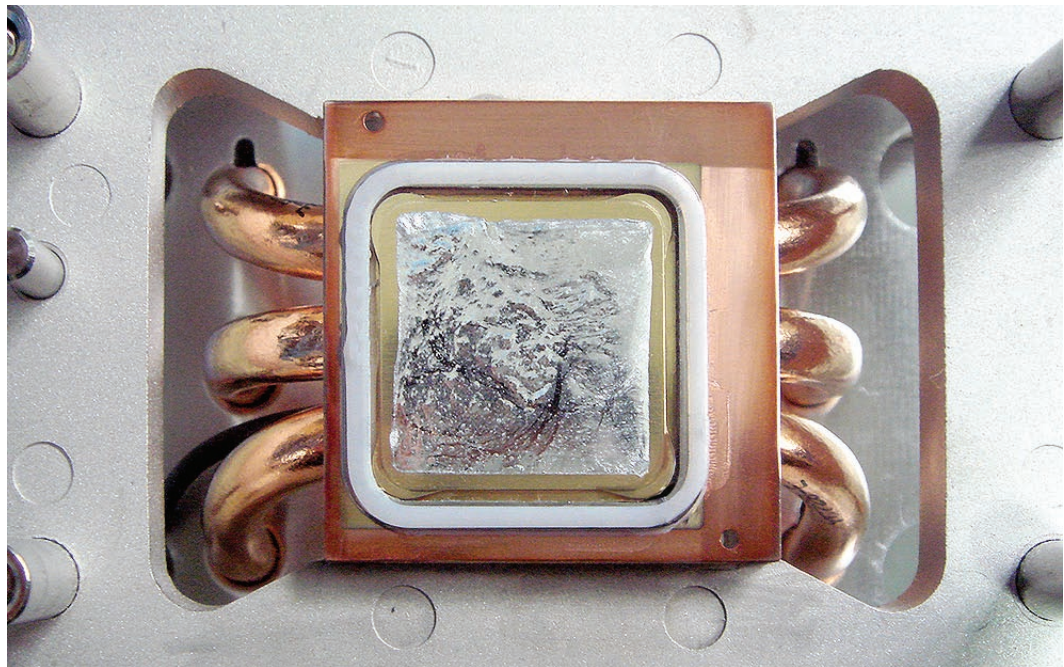

Unacceptable examples

The following are examples of unacceptable applications of the coating. Return new parts or replace existing parts that exhibit similar applications.

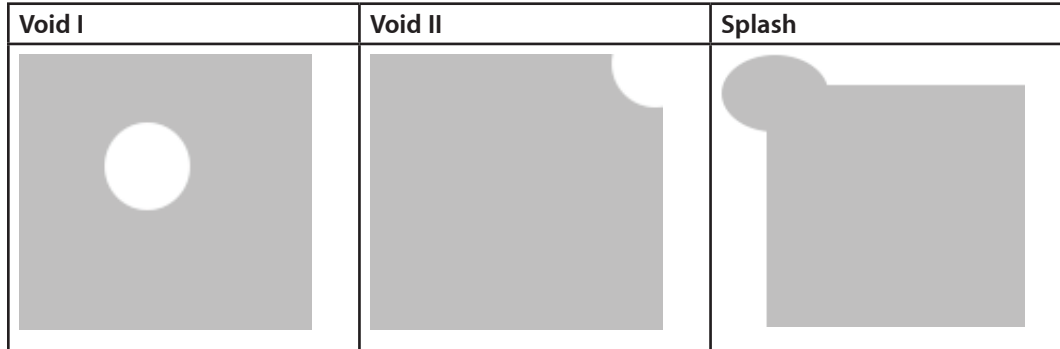

Void I: The silver-colored coating shows missing areas of within the normal coated area.

Void II: The silver-colored coating shows missing areas along the edge of the coated area.

Splash: The silver-colored coating extends beyond the normal coated area.

Important: If you observe a heatsink or processor with a “splash” of special coating, first try to remove the excess by using the method described below under “Removing Stray Particles of Coating.” If this approach does not remove the splash, return the part to Apple.

Removing Stray Particles of Coating

In rare cases, small particles or beads of the silver-colored coating may appear outside the normal coated area of a replacement heatsink or processor. You must remove these particles before installing the part. Failure to do so could result in damage to the part or the logic board.

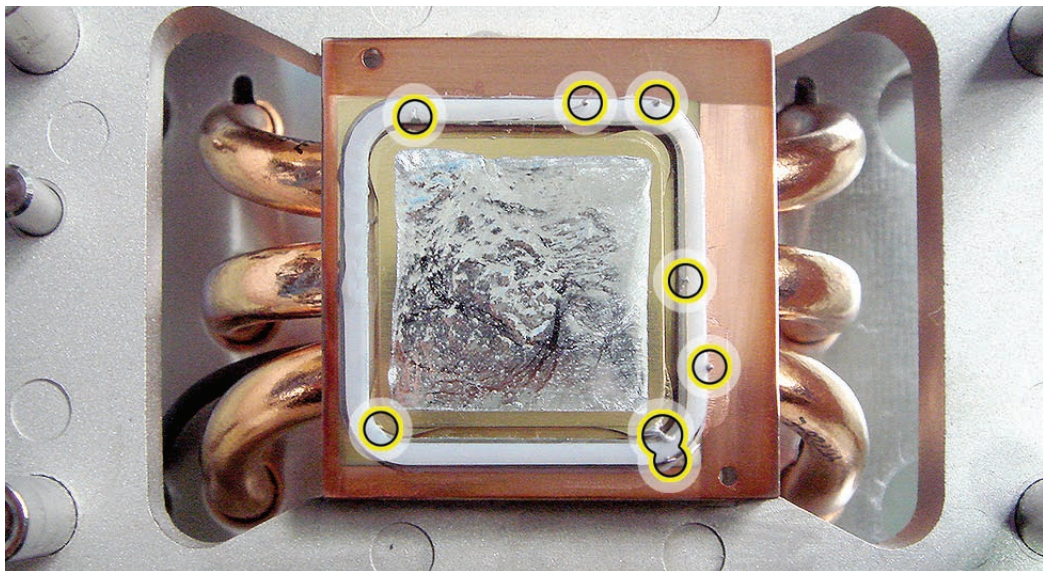

To remove the particles, use the suction pipette that comes with the replacement heatsink and processor. (The pipette is also available through GSX as part of the Mac Pro Grease Kit, part number 076-1258.) Depress the bulb end of the pipette, place the other end over the particle, and release the bulb. The particle will be suctioned into the pipette.

Once you have removed all stray particles, place the pipette inside the resealable bag included with the replacement part. Pack this bag along with the failed part in the box that the replacement part came in, and return the box to Apple.

Gasket on Heatsink

Check that the gasket that surrounds the silver-colored coating on the underside of the heatsink is in good condition, as shown below.

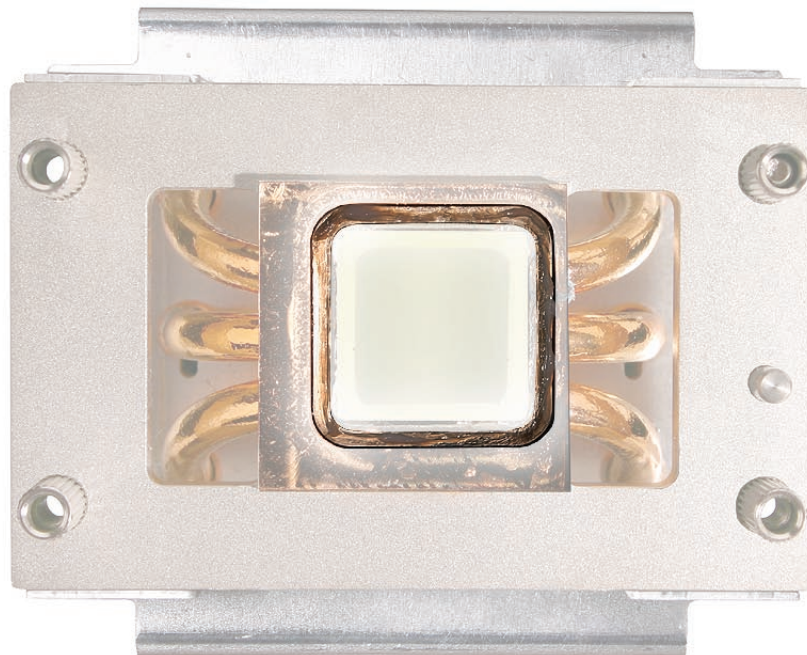

Replace the gasket if it shows obvious damage, such as cracks, folds, and broken-off surfaces, or if it is dislocated from the heatsink. The gasket is available through GSX as part of the Mac Pro Grease Kit, part number 076-1258.



Symptom Charts

How to Use the Symptom Charts

The Symptom Charts included in this chapter will help you diagnose specific symptoms related to the product. Because cures are listed on the charts in the order of most likely solution, try the cures in the order presented. Verify whether or not the product continues to exhibit the symptom. If the symptom persists, try the next cure.

Note: If a cure instructs you to replace a module, reinstall the original module before you proceed to the next cure.

Important: The only way to shut off power completely to the computer and display is to disconnect their power plugs from the power source. Make sure the power cords to the computer and display are within easy reach.

Startup Failures

When testing a computer for the following symptoms, remove the side access panel so you can better observe or listen for fan movement.

Note: Be sure to check the [“Memory”](#) and [“Power-On Self Test”](#) topics in the General Information section of this chapter. Incorrect installation of DIMMs or incompatible memory will not allow the system to start up correctly. For information on how to correctly install DIMMs, see the [“Memory \(DIMMs\)”](#) topic in the Take Apart chapter.

Important: For troubleshooting purposes, Mac Pro (8x) computers may be started up and diagnosed with a single processor installed in either the upper (CPU A) or lower (CPU B) position.

Power-on LED does not illuminate when power button is pressed, fans do not spin, and there is no boot tone or video

1. Verify power outlet is good.
2. Check that diagnostic LED 1 is on when the power cord is connected.
3. Replace power cord.
4. Check that diagnostic LED 1 is on when the power cord is connected.
5. Reset the logic board. Refer to “Resetting the Logic Board” in this chapter.
6. Verify power supply cables are fully connected.
7. Verify that processors are properly seated. Check diagnostic LED 2 and/or LED 3.

-
8. Verify that processors' mounting clamps are properly tightened.
 9. Test whether the front panel board or power button is at fault. Remove the installed front panel board and test with a known-good front panel board.
 10. Replace front panel board.
 11. Replace power button.
 12. Replace power supply.
 13. Replace logic board.

Power-on LED illuminates when pressed in, but goes out when button is released, there is no boot tone or video, but you can hear a small click

1. Check diagnostic LED 1 for trickle voltage from the power supply. Refer to "[Power Supply Verification](#)" in this chapter. If verification fails, replace power supply.
2. Verify that the processors are properly seated. Check diagnostic LED 2 and/or LED 3.
3. Verify that the processor mounting clamps are properly tightened.
4. Replace the power supply.

Power-on LED illuminates when power button is pressed but fans do not spin (or spin only momentarily) and there is no boot tone or video

1. Reseat video card. (Make sure video card is fully inserted in connector and end of card is secured by the connector latch.) For video cards that require power cables, check that they are connected.
2. Reset logic board. Refer to "[Resetting the Logic Board](#)" in this chapter.
3. Verify power supply cables are fully connected.
4. Check diagnostic LED 2 and/or LED 3 for processor connection.
5. Reseat processors and check for bent pins.
6. Check diagnostic LED 1 for trickle voltage from the power supply. Refer to "[Power Supply Verification](#)" in this chapter. If verification fails, replace power supply.
7. Replace logic board.
8. Replace processor.

Power-on LED illuminates when power button is pressed and fans spin continuously but there is no boot tone or video

1. Reseat video card. (Make sure video card is fully inserted in connector and end of card is secured by the connector latch.) For video cards that require power cables, check that they are connected.
2. Verify speaker cable is fully seated.
3. Reset logic board. Refer to "[Resetting the Logic Board](#)" in this chapter.

-
4. Check diagnostic LED 2 and/or LED 3 for processor connection
 5. If only one of the CPU Error LEDs (LED 2 or 3) comes on, try swapping the processors. If the Error LED follows the processor to the other processor location, replace that processor.
 6. Replace logic board

Power-on LED illuminates when power button is pressed, fans spin, and boot tone chimes, but there is no video

1. Verify display is properly connected and powered on.
2. Check video card connector and display cable for any bent pins.
3. Reseat video card. (Make sure video card is fully inserted in connector and end of card is secured by the connector latch.) For video cards that require power cables, check that they are connected.
4. Reset PRAM (restart computer while holding down Command-Option-P-R keys until second boot tone chimes)
5. Reset logic board. Refer to [“Resetting the Logic Board”](#) in this chapter.
6. Replace video card
7. Replace logic board

Power-on LED does not illuminate when power button is pressed, but fans spin, boot tone chimes, and there is video

1. Reseat front panel board
2. Replace front panel board
3. Replace logic board
4. Replace power supply

Power-on LED illuminates, fans spin up, no boot tone, and the system shuts down within a few minutes

1. Open the side access panel and observe all diagnostic LEDs. Refer to [“Diagnostic LEDs”](#) in this chapter for more information on how to locate and interpret these LEDs. Troubleshoot further if any LEDs indicate any failure.
2. Reseat the processors and check for bent pins
3. Replace the processors
4. Replace the logic board
5. Replace the power supply

Fans

Individual fan failure

1. Verify fan is properly connected.
2. Verify all other fans are working properly. If all fans seem to have failed, the problem is most likely not the fans. Reset the logic board to see if this resolves this problem.
3. Replace fan
4. Replace logic board

Fans run at high speed (computer may shut down or may just hang and not shut down as a result)

1. Check for proper ventilation around the exterior of the computer.
2. If the system is operating normally except for all fans running at full speed, try resetting the SMC.
3. If the system appears to be hung (unresponsive), then it's normal behavior for all fans to ramp to full speed. In this case, troubleshoot any possible operating system, RAM, processor, logic board, and power supply issues, in that order.
4. Remove the computer's side access panel and observe the diagnostic LEDs, specifically LED 4 and LED 5 (the CPU A and B Overtemp LEDs). Refer to "[Diagnostic LEDs](#)" in this chapter for more information on how to locate and interpret these LEDs. If either LED is flashing, it may indicate an initial processor over-temperature condition. If either LED is solidly on, it may indicate a chronic processor over temperature condition.
5. Verify proper processor heat sink installation (see the take apart section for more information on heat sink installation).
6. Verify all thermal sensors and their cables are properly connected, especially the ambient temperature sensor board.
7. Verify all fans are operating properly and are unobstructed, especially the front intake fan.
8. Verify that the proper type of memory is installed. (See "[Memory](#)" in the Take Apart chapter for more information.)
9. Replace power supply.

Computer performance seems sluggish or slow, or computer is completely hung

1. Start up the computer from a known-good volume, such as its Installation disc, or an external hard drive, to isolate the issue to software or hardware. If the computer seems to perform adequately when booted in this way, troubleshoot as a software issue. If the computer continues to perform sluggishly when booted this way, continue following the steps below.
2. Run Apple Service Diagnostic to verify hardware is functional. Address any diagnostic failures as necessary.

-
3. Check for proper ventilation around the exterior of the computer.
 4. Remove the computer's side access panel and observe the diagnostic LEDs, specifically LED 4 and LED 5 (the CPU A and B Overtemp LEDs). Refer to "[Diagnostic LEDs](#)" in this chapter for more information on how to locate and interpret these LEDs. If either of these LEDs is flashing, this may indicate an initial processor over temperature condition. If either of these LEDs is solidly on, this may indicate a chronic processor over temperature condition. Initial processor over-temperature can cause symptoms such as sluggish computer performance. A chronic processor over-temperature condition can cause the computer to hang completely.
 5. Verify proper processor heat sink installation. (Refer to "[Processor Heatsinks](#)" in the Take Apart chapter for more information.)
 6. Verify all thermal sensors and their cables are properly connected, especially the ambient temperature sensor board.
 7. Verify all fans are operating properly and are unobstructed, especially the front intake fan.

AirPort Extreme Card

AirPort Extreme Card does not appear to function and is not recognized by System Profiler

1. Start up the computer from a known-good volume (such as an external hard drive) with AirPort driver software installed, to isolate the issue to software or hardware. If the computer seems to perform adequately when booted in this way, troubleshoot as a software issue. If the computer continues to exhibit the issue, follow the steps below.
2. Reseat card and antenna cables connected to card
3. Replace card
4. Replace logic board

AirPort Extreme Card does not appear to function or has weak performance and is recognized by System Profiler

1. Start up the computer from a known-good volume (such as an external hard drive) with AirPort driver software installed, to isolate the issue to software or hardware. If the computer seems to perform adequately when booted in this way, troubleshoot as a software issue. If the computer continues to exhibit the issue, follow the steps below.
2. Reseat card and antenna cables connected to card
3. Replace card
4. Replace logic board
5. Replace AirPort Extreme antenna board / cable assembly

Bluetooth Card

Bluetooth Card does not appear to function and is not recognized by System Profiler

1. Start up the computer from a known-good volume (such as an external hard drive) with Bluetooth driver software installed, to isolate the issue to software or hardware. If the computer seems to perform adequately when booted in this way, troubleshoot as a software issue. If the computer continues to exhibit the issue, follow the steps below.
2. Reseat card and antenna cable connected to card
3. Replace card
4. Replace logic board

Bluetooth Card does not appear to function or has weak performance and is recognized by System Profiler

1. Start up the computer from a known-good volume (such as an external hard drive) with Bluetooth driver software installed, to isolate the issue to software or hardware. If the computer seems to perform adequately when booted in this way, troubleshoot as a software issue. If the computer continues to exhibit the issue, follow the steps below.
2. Reseat card and antenna cable connected to card
3. Replace card
4. If poor signal strength is the issue, replace the Bluetooth antenna board / cable assembly
5. Replace logic board

Other Failures

Optical drive

1. Try different optical media.
2. If two drives are installed, check the Master/Slave or Cable Select jumpers on both optical drives (this will depend on drive vendor). Both drives should be set to 'Cable Select' mode for proper operation.
3. If two drives are installed, test one optical drive at a time by disconnecting one of the drives to see if the other one works.
4. Replace optical drive cable
5. Replace optical drive
6. Replace logic board

Front Panel FireWire port

1. Reset SMC.
2. Reseat front panel board cables
3. Replace front panel board cables
4. Reseat front panel board
5. Replace front panel board
6. Replace logic board

Rear FireWire port

1. Reset SMC.
2. Replace logic board

Front Panel USB 2.0 port

1. Reseat front panel board cables
2. Replace front panel board cables
3. Reseat front panel board
4. Replace front panel board
5. Replace logic board

Rear Panel USB 2.0 port

Replace logic board

Internal speaker

1. The Mac Pro (8x) should emit a startup chime through its internal speaker, regardless of whether headphones or external speakers are connected. If you hear a normal startup chime, but no other audio is produced from the internal speaker, and there is nothing connected to either audio-out port, suspect a damaged front panel headphone port or rear audio-out port. In this case, replace the front panel board or logic board as necessary. If you do not hear a startup chime through the internal speaker, even after resetting PRAM, follow the steps below.
2. Check the sound output settings in the Sound preferences to ensure the internal speaker is selected.
3. Check speaker cable connection
4. Replace speaker
5. Replace logic board

Audio IO (front headphones)

1. Start up the computer from a known-good volume (such as its Installation disc or an external hard drive), to isolate the issue to software or hardware. If the computer seems to perform adequately when booted in this way, troubleshoot as a software issue. If the computer continues to exhibit the issue, follow the steps below.
2. Reset PRAM
3. Reseat front panel board
4. Replace front panel board
5. Replace logic board

Audio IO (rear audio line in; rear audio line out)

1. Start up the computer from a known-good volume (such as its Installation disc or an external hard drive), to isolate the issue to software or hardware. If the computer seems to perform adequately when booted in this way, troubleshoot as a software issue. If the computer continues to exhibit the issue, follow the steps below.
2. Check Sound settings in System Preferences
3. Reset PRAM
4. Replace logic board



Upgrades
Mac Pro (8x)



AirPort Extreme Card

Important: The computer enclosure includes AirPort antenna wires and a Bluetooth antenna wire. The Bluetooth antenna wire looks similar to the AirPort antenna wires, except that it includes a “BT” label. For proper operation, be careful not to connect the Bluetooth antenna wire to the AirPort card or any AirPort antenna wire to the Bluetooth card.

Note: You may connect the AirPort antenna wires to either AirPort card connector.

Tools

The only tool required for this procedure is a magnetized jewelers Phillips #1 screwdriver.

Preliminary Steps

Before you begin, open the computer, and lay it on its side with the access side facing up.

Part Location

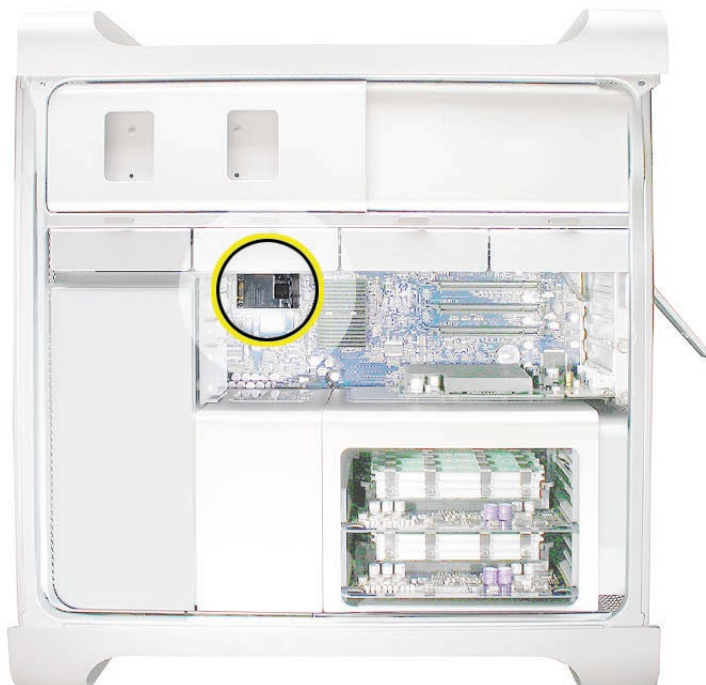

Procedure

1. Connect the AirPort antenna wires to the connectors on the card.
Important: Be sure to connect the wires that are marked 1 and 3 to the card; the antenna wire that is marked 2 should be taped out of the way.

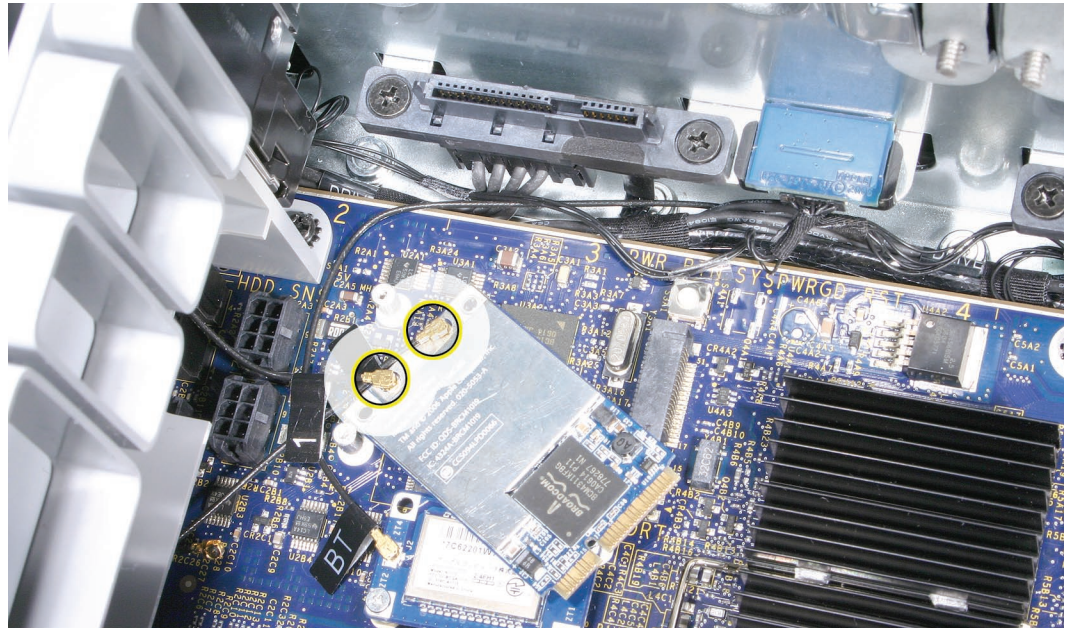

2. Insert the AirPort Extreme card into its logic board connector at an angle, as illustrated. Then lower the screw end of the card down to the standoffs on the logic board.

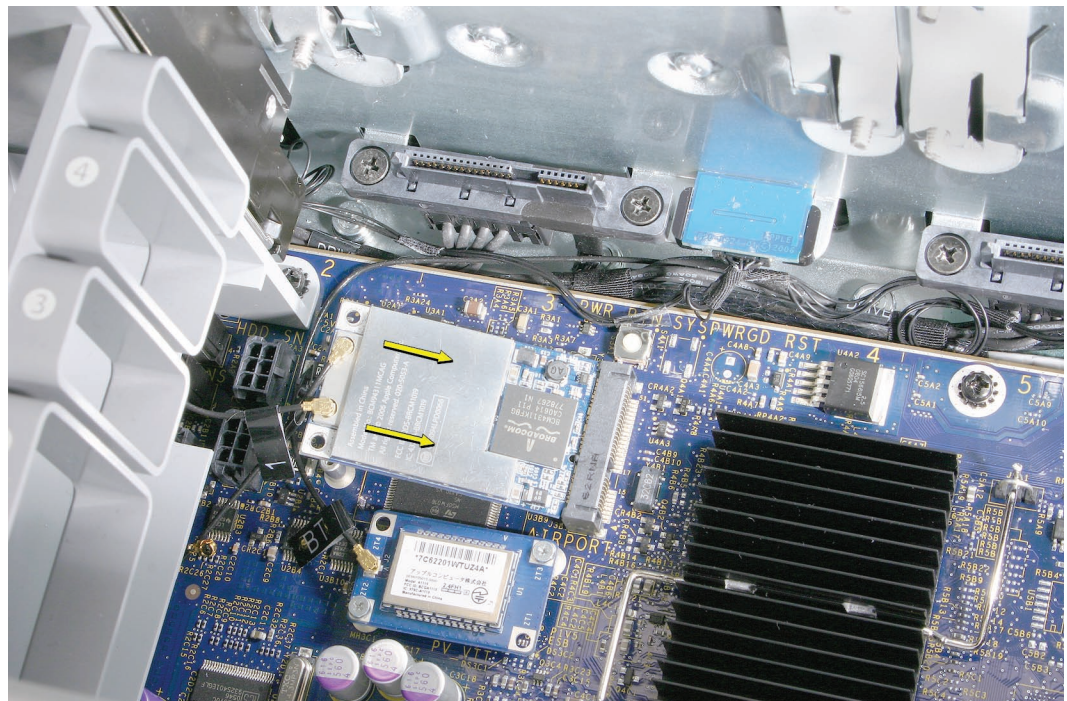

3. Install the two AirPort Extreme card mounting screws.

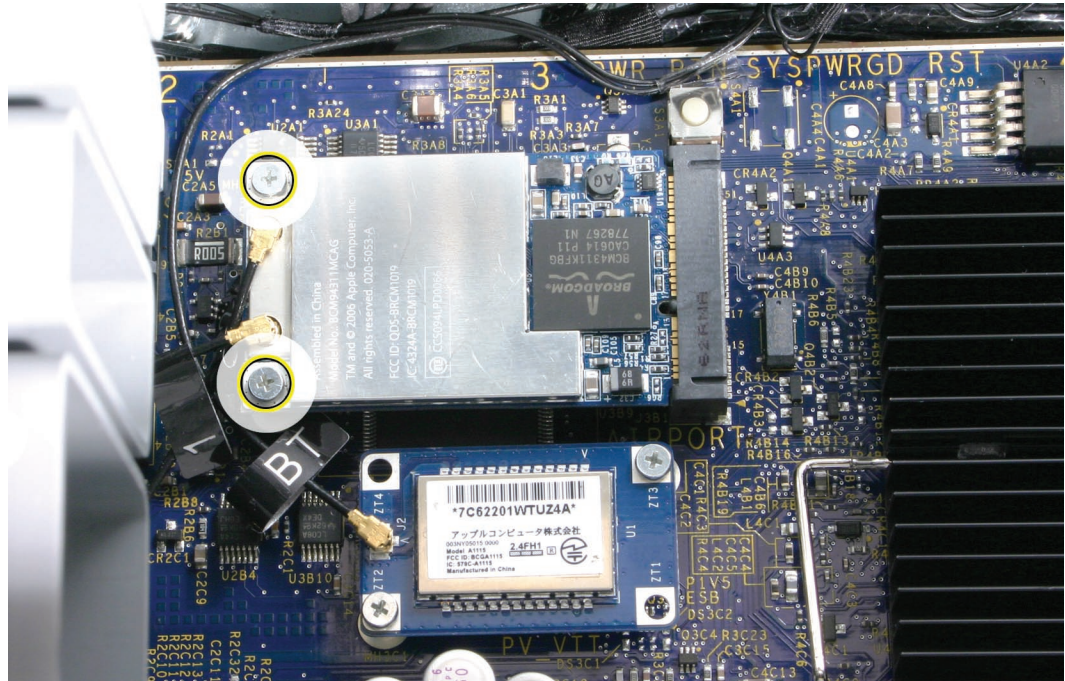



Bluetooth Card

Important: The computer enclosure includes one Bluetooth antenna wire, which looks similar to the AirPort antenna wires, except that it includes a “BT” label. If the label is missing, you can also identify the Bluetooth cable by its location; it is the cable that runs to the back of the computer. For proper operation, be careful not to connect the Bluetooth antenna wire to the AirPort card or any AirPort antenna wire to the Bluetooth card.

Tools

The only tool required for this procedure is a magnetized jewelers Phillips #1 screwdriver.

Preliminary Steps

Before you begin, open the computer, and lay it on its side with the access side facing up.

Part Location

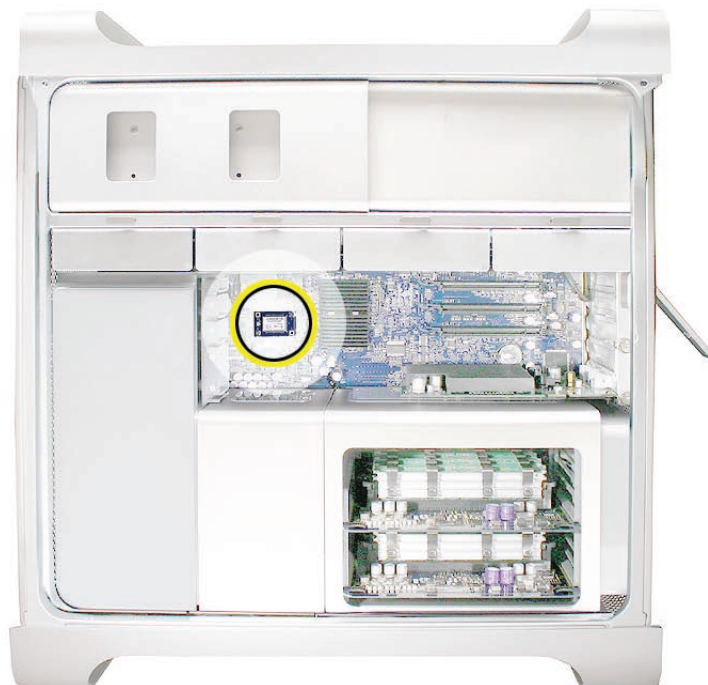

Procedure

1. Connect the Bluetooth antenna wire to the connector on the Bluetooth card.



2. Lower the card onto the Bluetooth connector on the logic board.
3. Install the two Bluetooth card mounting screws.

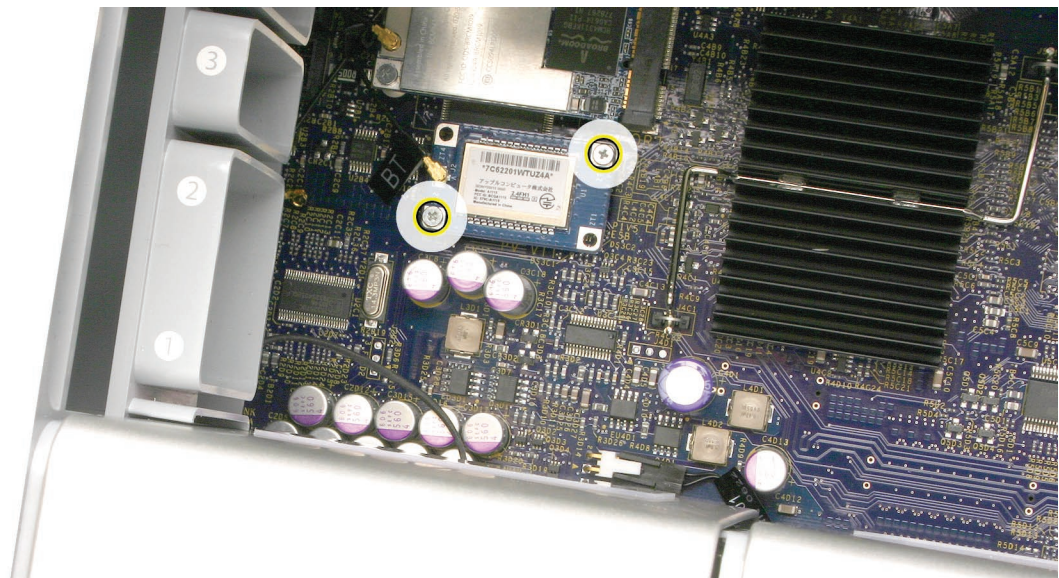



PCI Express/Graphics Card

The Mac Pro (8x) logic board includes one double-wide PCI Express graphics slot and three PCI Express expansion slots, for a total of four slots. The computer comes with a graphics card installed in slot 1. You can install additional PCI Express graphics and expansion cards in the remaining three PCI Express expansion slots.

Important: Combined maximum power consumption for all four PCI Express slots must not exceed 300 W.

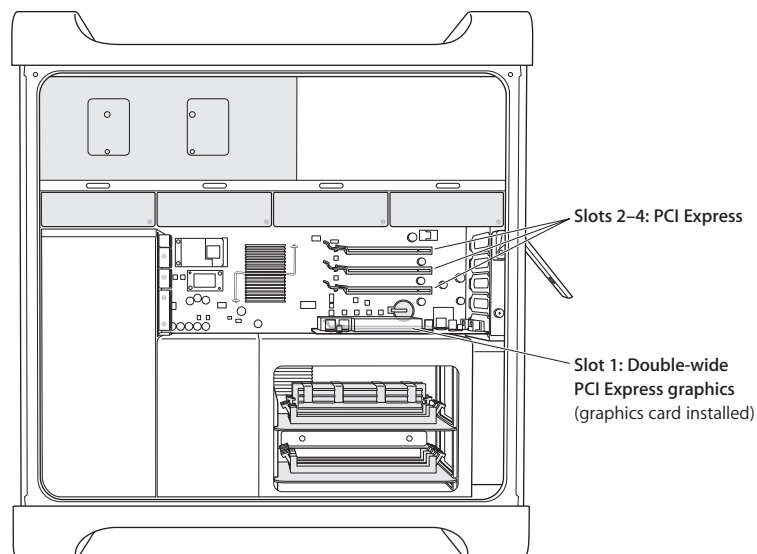

Tools

The only tool required for this procedure is a Phillips #1 screwdriver.

Preliminary Steps

Before you begin, open the computer, and lay it on its side with the access side facing up.

Note: You may also find it helpful to remove the [hard drives and carriers](#) and any adjacent PCI Express cards before beginning this procedure.

Part Location



Procedure

This procedure explains how to install a standard card and a card that includes a booster cable. Before you can install either type of card, however, you must first loosen the two captive screws that secure the PCI bracket to the enclosure and remove the bracket. You must also remove the port cover for the PCI slot where you are installing the new card.

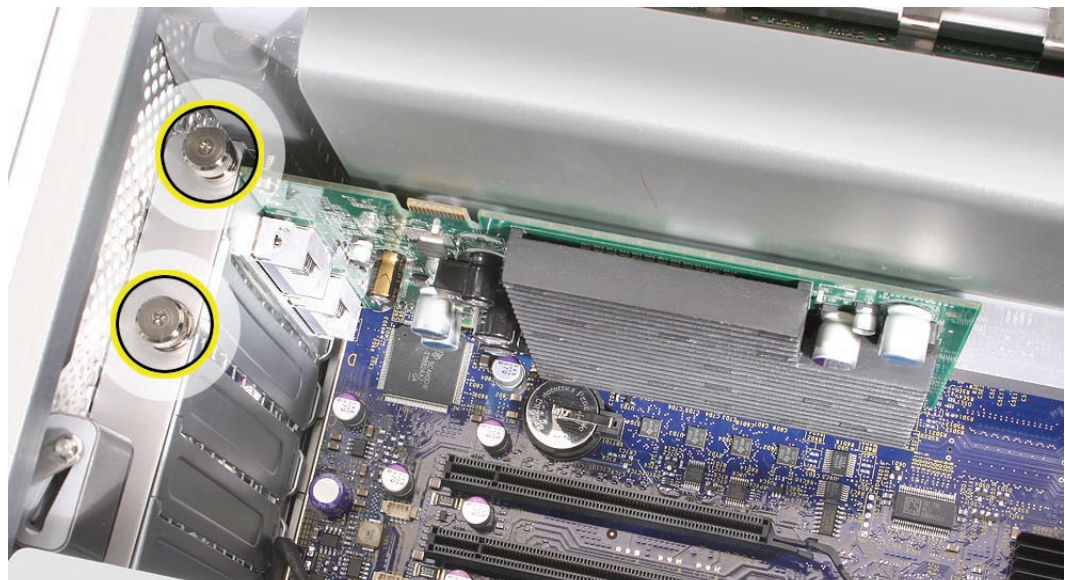

Warning: When installing or removing a card, handle it only by the edges. Do not touch its connectors or any of the components on the card.

Standard Card

1. Align the card's connector with the expansion slot and press until the connector is inserted all the way into the slot. If you're installing a 12-inch card, make sure the card engages the appropriate slot in the PCI card guide.
 - Don't rock the card from side to side; instead, press the card straight down into the slot.
 - Don't force the card. If you meet a lot of resistance, pull the card out. Check the connector and the slot for damage or obstructions, then try inserting the card again.
 - Pull the card gently to see if it is properly connected. If it resists and stays in place and its gold connectors are barely visible, the card is connected.

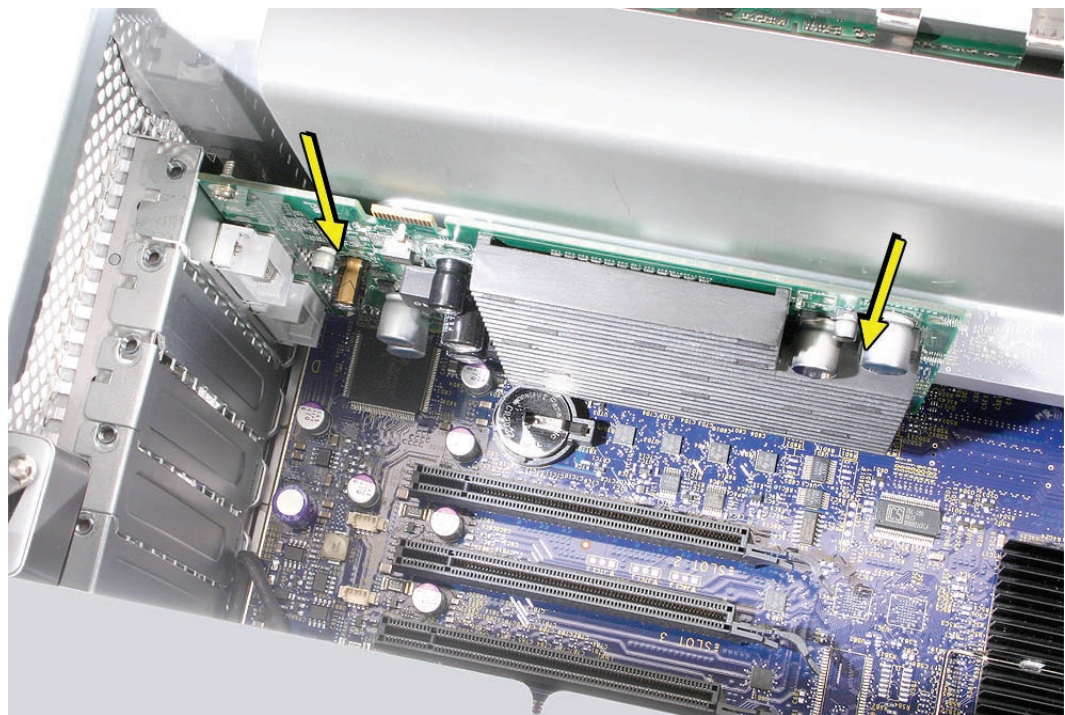

2. Replace the PCI bracket and tighten the two screws that secure it to the enclosure.

Card with Booster Cable

1. Connect the booster cable to the card.

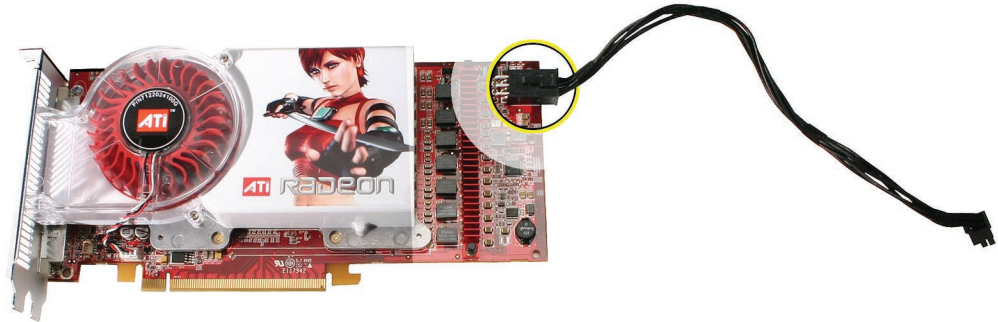

2. Holding the card by the top corners, insert it straight down into its expansion slot.

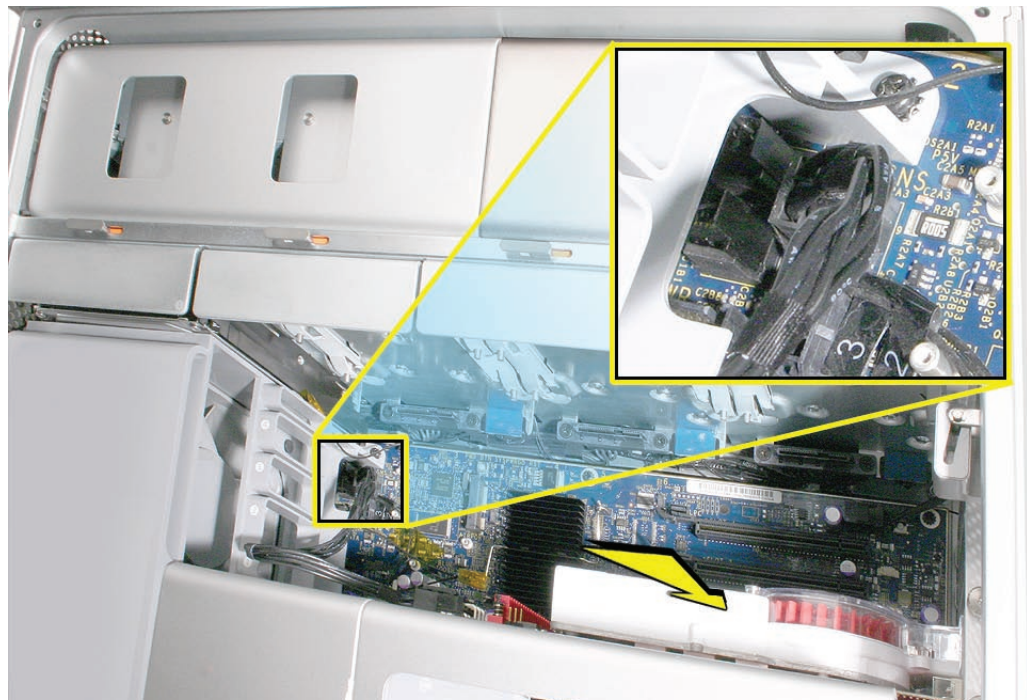

3. Connect the booster cable to the logic board.

Note: There are two logic board connectors for booster cables. Connect the booster cable for a card in PCI slot 1 to the connector that is closest to the heatsink cover. Connect the booster cable for a card in PCI slot 2 to the connector closest to the media shelf.

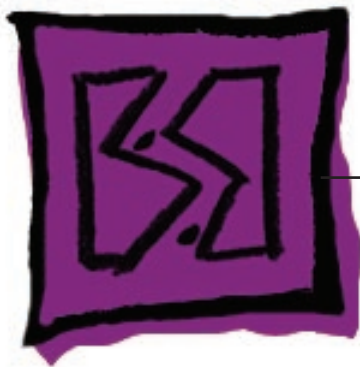

Views

Mac Pro (8x)



Exploded Views

Exploded View 1

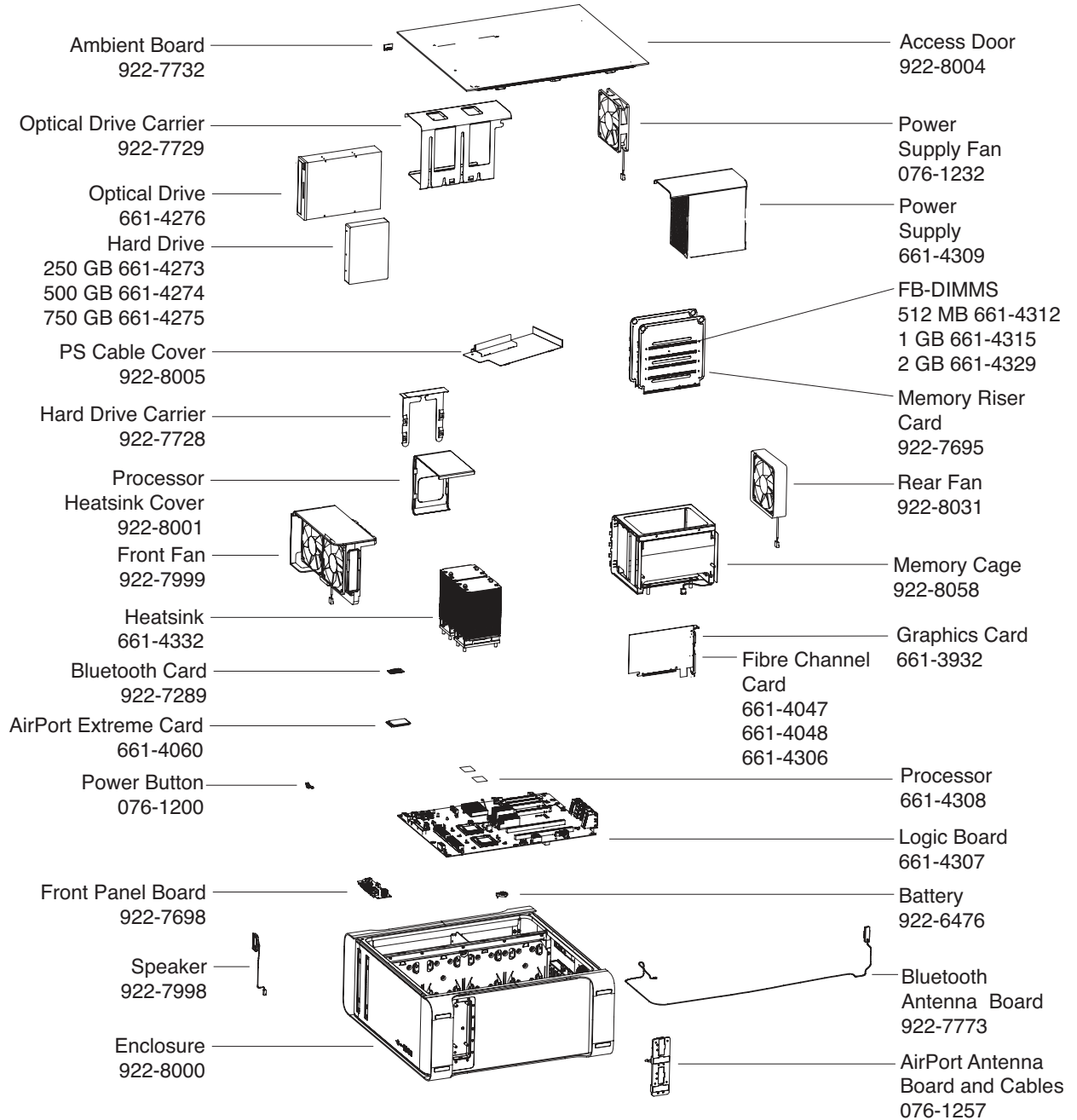

Exploded View 2

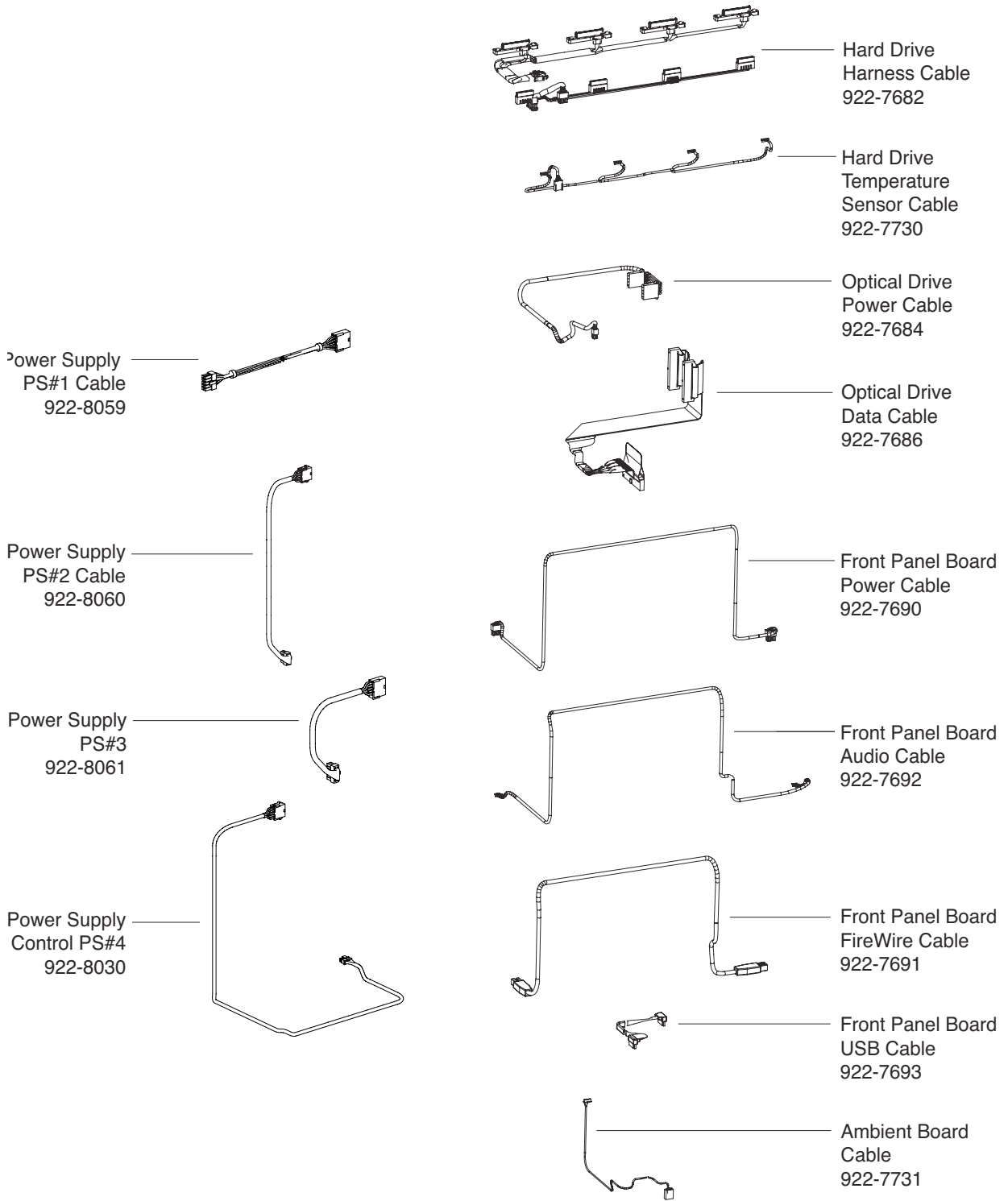



External Views

Front View

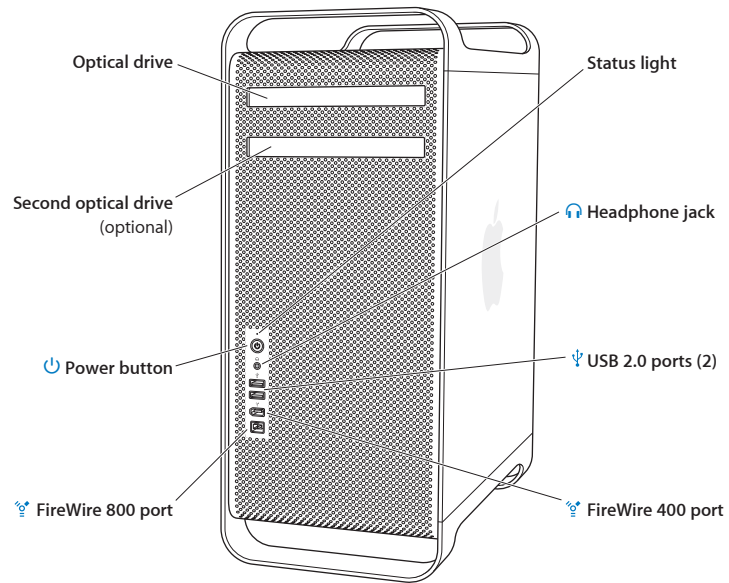

Rear Views

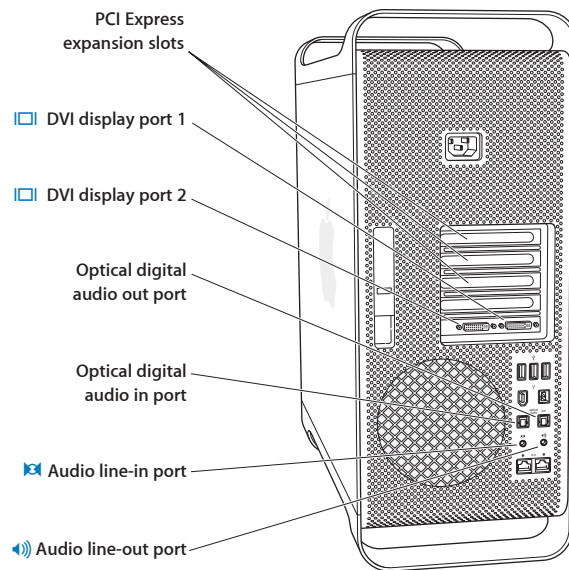
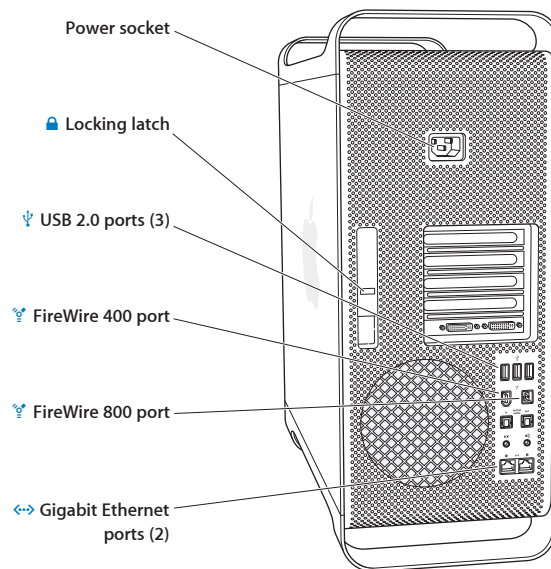

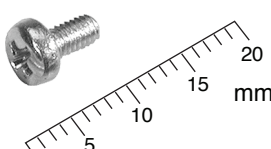
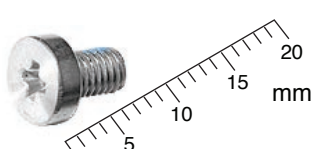
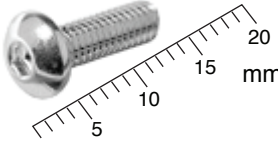
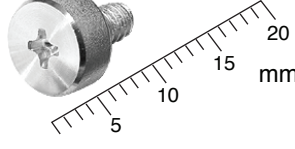
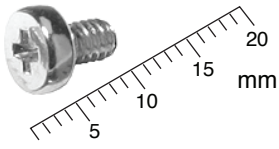
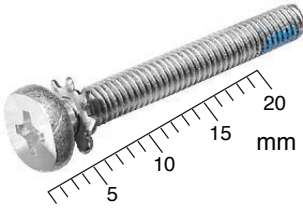
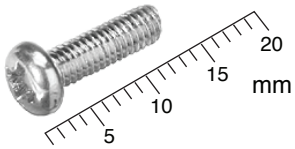

Screw Matrix

<p>922-5974</p>  <p>Logic board, frt panel board, front fan</p>	<p>922-6252</p>  <p>Speaker assembly</p>	<p>922-7703</p>  <p>Memory cage, optical drive</p>
<p>922-7704</p>  <p>Power supply</p>	<p>922-7705</p>  <p>AirPort antenna board</p>	<p>922-7706</p>  <p>Hard drive</p>
<p>922-7734</p>  <p>AirPort/Bluetooth card</p>	<p>922-7741</p>  <p>Memory cage</p>	<p>922-7756</p>  <p>Speaker</p>
<p>922-8003</p>  <p>Front fan</p>		