



Centris 660AV/Quadra
660AV



Basic Navigation Within Service Source

Plug-Ins:



Find

Searches the current document only

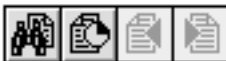

Search

Searches across all Acrobat documents



Service Source Main Menu



Service Source Parts Database



Web Link

- Product Name
- ▶ BASICS
- ▶ SPECIFICATIONS
- ▶ TROUBLESHOOTING
- ▶ TAKE APART
- EXPLODED VIEW

When viewing Service Source Acrobat procedures with bookmarks active (the default setting), you can click a chapter title to go directly to that chapter. You can also click the triangle to reveal and directly access topics within the chapters.

When printing pages from Acrobat, use these numbers to specify the page range you wish to print. The page numbers at the top of procedure pages are relative to each chapter, not to the whole document.

Go to Next page

Go to Previous page

Indicates the end of a topic

Indicates a topic that is two or more pages





Basics

Centris 660AV/Quadra 660AV





Overview

This manual includes complete repair procedures for the Centris 660AV and Quadra 660AV shown at left.

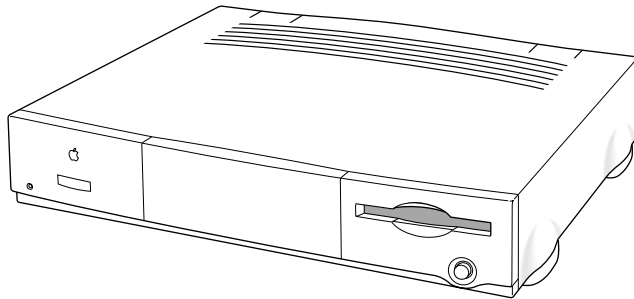

Figure: Centris 660AV and Quadra 660AV





Specifications

Centris 660AV/Quadra 660AV





Processors

Processor

Motorola 68040

25 MHz

Built-in paged memory management unit (PMMU), floating point unit (FPU), and 8K memory cache

Addressing

32-bit registers

32-bit address/data bus

Direct Memory Access (DMA)

A Peripheral Subsystem Controller (PSC) provides direct memory access (DMA) between the 68040 buses and peripheral devices





**Digital Signal
Processor (DSP)**

AT&T DSP3210 32-bit floating-point digital signal processor
Supports real-time tasks such as speech recognition, audio
compression, and analog modem signal processing.





Memory

| | |
|-------------|--|
| RAM | 8 MB (4 MB soldered DRAM plus 4 MB SIMM) standard, expandable to 68 MB 72-pin SIMMs 70 ns access time |
| ROM | 1 MB soldered on logic board |
| PRAM | 256 bytes of parameter memory |



**VRAM**

1 MB (two banks of 512K VRAM soldered on board)

**Clock/Calendar
Calendar**

Maximum pixel depths for graphics:

- 12-inch RGB (512 x 384) 24 bits per pixel
- 13/14-inch RGB (640 x 480) 16 bits per pixel
- 12-inch monochrome (640 x 480) 8 bits per pixel
- 15-inch portrait (640 x 870) - 8 bits per pixel
- 16-inch RGB (832 x 624) - 16 bits per pixel
- 19-inch RGB (1024 x 768) - 8 bits per pixel
- 21-inch monochrome (1152 x 870) - 8 bits per pixel
- 21-inch RGB (1152 x 870) - 8 bits per pixel
- VGA (640 x 480) - 16 bits per pixel
- SVGA (800 x 600) - 16 bits per pixel

CMOS custom chip with long-life lithium battery





Disk Storage

Floppy Drive

1.4 MB Apple SuperDrive

Hard Drive

3.5 in., internal 80 or 500 MB hard drive

CD-ROM

Optional internal 5.25 in. CD-ROM drive





I/O Interfaces

Expansion Slot

Internal expansion slot supports either NuBus, processor-direct slot (PDS) card, or digital audio/video expansion (DAVE) card (with appropriate adapter)

SCSI

One SCSI port; DB-25 connector
Supports a maximum of six external devices (internal SCSI devices include the computer, which is always device 7)

Apple Desktop Bus

Two Apple Desktop Bus (ADB) ports for keyboard, mouse, and low-speed input devices; mini DIN-4 connectors

Expansion Slot

Internal expansion slot supports either a processor-direct slot card or 7-inch NuBus card (with appropriate adapter)



**Serial**

Two RS-232/RS-422 serial ports
One mini DIN-8 port
One mini DIN-9 high performance modem port
230.4 Kbps maximum

**High-Performance
Serial Port (Modem
Port)**

Supports connection to analog, PBX, ISDN, facsimile (FAX), and data telephone lines
Provides full-duplex telephone I/O at up to 14.4 Kbps
AppleTalk and V.22, V22.bis, V.29, and V.32 modem protocols supported
Supports Apple HiPPort protocols
0.92 Mbps maximum, clocked externally

Ethernet

One Ethernet port; AUI-15 connector





| | |
|------------------------|---|
| Audio | <p>One 16-bit stereo output port; one 16-bit stereo input port; stereo mini phone jack connectors</p> <p>Sample rates up to 48 kHz (44.1 kHz standard rate)</p> <p>Uses the digital signal processor (DSP) chip</p> <p>Supports stereo audio from internal CD drive</p> |
| Video | <p>Video monitor port; DB-15 connector</p> <p>Supports Apple monitors (up to 16 bits), NTSC, and PAL monitors</p> <p>Supports VGA and SVGA monitors (with adapter cables)</p> |
| Composite Video | <p>Input port; RCA phono connector</p> <p>Output port; RCA phono connector</p> |
| S-video | <p>Input port; DIN-7 connector</p> <p>Output port; DIN-4 connector</p> |





I/O Devices

Keyboard

Standard, extended, or adjustable keyboard connected through two ADB ports

Maximum power draw for all ADB devices: 500 mA

Keyboard draws 25-80 mA

Mouse

ADB Mouse II; mechanical tracking optical shaft or contact encoding (low power)

Draws up to 80 mA

Microphone

Optional electret, omnidirectional microphone

Microphone output voltage is 4 mV peak to peak at normal value

Mini phone plug connector





Sound and Video

Sound Generator

Enhanced Apple sound chip (EASC), including four-voice wave table synthesis and stereo sampling generator capable of driving stereo mini phone-jack headphones or stereo equipment

Video

Built-in VRAM video support for all Apple monitors (requires an adapter for 21 in. monitors)
Supports many types of NTSC, PAL, VGA





Electrical

A/C Line Voltage

100-240 VAC

Frequency

50-60 Hz

86 W

Power

CMOS custom chip with long-life lithium battery





Physical

Dimensions

Height: 3.4 in. (8.5 cm)

Width: 16.3 in. (41.5cm)

Depth: 15.6 in (39.7 cm)

Weight

14.0 lbs (6.4 kg) (weight varies based on internal devices installed)





Environmental

**Operating
Temperature**

10-40° C (50-104 ° F)

**Storage
Temperature**

-40 to 47° C (-40 F to 116.6° F)

Relative Humidity

Operating: 10-90% (noncondensing)

Altitude

0-10,000 ft. (3,048 m)





Troubleshooting

Centris 660AV/Quadra 660AV





General

The Symptom Charts included in this chapter will help you diagnose specific symptoms related to your product. Because cures are listed on the charts in the order of most likely solution, try the first cure first. Verify whether or not the product continues to exhibit the symptom. If the symptom persists, try the next cure. (Note: If you have replaced a module, reinstall the original module before you proceed to the next cure.)

If you are not sure what the problem is, or if the Symptom Charts do not resolve the problem, refer to the Flowchart for the product family.

For additional assistance, contact Apple Technical Support.





Symptom Charts

Error Chords

One-part error chord sounds during startup sequence

- 1 Disconnect SCSI data cable and hard drive power cable. Reboot system. If startup sequence is normal, run Macintosh Hard Disk Test and replace hard drive, if necessary.
- 2 Disconnect floppy drive cable connector and reboot system. If startup sequence is normal, replace floppy drive.
- 3 Replace logic board. Retain customer's SIMMs.

Two-part error chord sounds during startup sequence

- 1 Replace DRAM SIMMs.
- 2 Replace logic board. Retain customer's SIMMs.
- 3 Perform DRAM SIMM verification on replacement logic board.





System

Does not power on,
screen is black, fan is
not running, and LED
is not lit

- 1 Check cables.
- 2 Plug monitor directly into wall socket and verify that monitor has power.
- 3 Replace power cord.
- 4 Replace power supply.
- 5 Replace logic board. Retain customer's SIMMs.

Clicking, Chirping, or
thumping

- 1 Replace power supply.
- 2 Replace logic board. Retain customer's SIMMs.





System (Continued)

System shuts down
intermittently

- 1 Make sure air vents are clear. Thermal protection circuitry may shut down system. After 30 to 40 minutes, system should be OK.
- 2 Replace power cord.
- 3 Check battery. Refer to “Battery
- 4 Verification” in Additional Procedures.
- 5 Replace power supply.
- 6 Replace logic board. Retain customer’s SIMMs.

System
intermittently
crashes or locks up

- 1 Verify that system software is correct version.
- 2 Verify that application software is known-good.
- 3 Replace SIMMs.
- 4 Replace logic board. Retain customer’s SIMMs.
- 5 Replace power supply.





Floppy Drive

Audio and video present, but internal floppy drive does not operate

- 1 Replace disk with known-good.
- 2 Verify that all external SCSI devices
- 3 are disconnected.
- 4 Replace floppy drive cable.
- 5 Replace floppy drive.
- 6 Replace logic board. Retain customer's SIMMs.
- 7 Replace power supply.

Disk ejects, display shows icon with blinking "X"

- 1 Replace disk with known-good system disk.
- 2 Replace internal floppy drive cable.
- 3 Replace internal floppy drive.
- 4 Replace logic board. Retain customer's SIMMs





Floppy Drive (Continued)

- | | |
|---|--|
| Does not eject disk | <ol style="list-style-type: none">1 Switch off computer. Hold mouse $\Sigma\Sigma$ button down while you switch computer on.2 Replace floppy drive cable3 Replace internal floppy drive.4 Replace logic board. Retain customer's SIMMs |
| Attempt to eject disk, but doesn't | <ol style="list-style-type: none">1 Push disk completely in.2 Reseat floppy drive bezel and drive so bezel slot aligns correctly with drive.3 Eject disk manually.4 Replace floppy drive. |
| Internal floppy drive runs continuously | <ol style="list-style-type: none">1 Replace disk with known-good system disk.2 Replace internal floppy drive cable.3 Replace internal floppy drive.4 Replace logic board. Retain customer's SIMMs. |





Floppy Drive (Continued)

MS-DOS drive does not recognize disk formatted on 1.4 MB drive

To read and write files with either MS-DOS or 1.4 MB drive, format all disks with MS-DOS drive first.





Video

Screen is black, audio and at least one drive operate, fan is running, and LED is lit

- 1 Adjust brightness. See Adjustments chapter in appropriate monitor manual.
- 2 Verify that monitor is switched on.
- 3 Clear parameter RAM. Hold down <Shift> <Option> <P> <R> during startup but before “Welcome To Macintosh” appears.
- 4 Replace video cable.
- 5 Replace monitor. Refer to appropriate monitor manual to troubleshoot defective monitor.
- 6 Replace video card, if present
- 7 Replace SIMMs. See $\Sigma\Sigma$ Memory manual.
- 8 Replace logic board. Retain customer’s SIMMs.
- 9 Replace power supply.





Video (Continued)

Screen is black, audio and drive do not operate, but fan is running and LED is lit

- 1 Remove peripherals.
- 2 Remove expansion card.
- 3 Replace DRAM SIMMs. See Memory
- 4 manual.
- 5 Replace power supply.
- 6 Replace logic board.

Partial or whole screen is bright and audio is present, but no video information is visible

- 1 Replace monitor. Refer to appropriate monitor manual to troubleshoot defective monitor.
- 2 Replace video cable.
- 3 Replace video card, if installed.
- 4 Clear parameter RAM. Hold down <Shift> <Option> <P> <R> during startup but before “Welcome To Macintosh” appears.
- 5 Replace logic board. Retain customer’s SIMMs.





Hard Drive

Internal hard drive will not operate; drive doesn't spin

- 1 Replace SCSI data cable.
- 2 Replace hard drive.
- 3 Replace power supply.
- 4 Replace logic board. Retain customer's SIMMs.

Drive does not appear on the desktop

- 1 Verify that there are no duplicate SCSI device addresses.
- 2 Clear parameter RAM. Hold down <Shift> <Option> <P> <R> during startup but before "Welcome To Macintosh" appears.
- 3 Verify that drive is initialized. If it isn't, use "HD SC Setup" to initialize drive.
- 4 Replace SCSI data cable.
- 5 Replace hard drive.





Hard Drive (Continued)

Works with internal or external SCSI devices but not with both

- 1 Verify that there are no duplicate SCSI device addresses.
- 2 Replace terminator on external device.
- 3 Replace external SCSI data cables.
- 4 Refer to appropriate manual to troubleshoot defective external device.





CD-ROM drive

CD-ROM drive does not accept a compact disc

- 1 Exchange disc (if disc is dirty or damaged).
- 2 Verify that CD-ROM carrier is installed properly.
- 3 Replace CD-ROM drive mechanism.

Macintosh does not display CD-ROM drive icon

- 1 Verify that CD-ROM extension is in System Folder.
- 2 Replace SCSI data cable.
- 3 Replace CD-ROM drive mechanism.
- 4 Replace logic board.

Compact disc won't eject from the drive

- 1 Manually eject the compact disc.
- 2 Press the eject $\Sigma\Sigma$ button behind the front bezel (if it is accessible).
- 3 Replace the CD-ROM drive mechanism.





Peripheral

Cursor does not move

- 1 Check mouse connection.
- 2 Inspect inside of mouse for buildup of dirt or other contaminants. Clean mouse if necessary.
- 3 If mouse was connected to keyboard, connect it to computer ADB port instead. If mouse works, replace keyboard or ADB cable.
- 4 If mouse does not work in any ADB port on computer, replace mouse.
- 5 Replace logic board. Retain customer's SIMMs.

Cursor moves, but
ΣΣclicking mouse
ΣΣbutton has no effect

- 1 Replace mouse.
- 2 Replace logic board. Retain customer's SIMMs.





Peripheral (Continued)

Cannot double-click to open application, disk, or server

- 1 Remove duplicate System files from
- 2 hard drive.
- 3 Clear parameter RAM. Hold down <Shift> <Option> <P> <R> during startup but before “Welcome to Macintosh” appears.
- 4 If mouse was connected to keyboard, connect mouse to computer ADB port instead. If mouse works, replace keyboard or ADB cable.
- 5 If mouse does not work in any ADB port on computer, replace mouse.
- 6 Replace logic board. Retain customer’s SIMMs.

No response to any key on keyboard

- 1 Check keyboard connection to ADB port.
- 2 Replace keyboard cable.
- 3 Replace keyboard.
- 4 Replace logic board. Retain customer’s SIMMs.





Peripheral (Continued)

Known-good serial printer will not print

- 1 Verify that system software is correct version.
- 2 Make sure Chooser and Control Panel settings are correct.
- 3 Replace printer interface cable.
- 4 Replace logic board. Retain customer's SIMMs.

Known-good printer on a network will not print

- 1 Verify that system software is correct version.
- 2 Make sure Chooser and Control Panel settings are correct.
- 3 Refer to Networks manual.
- 4 Replace logic board. Retain customer's SIMMs.





Miscellaneous

No sound from speaker

- 1 Verify that volume setting in Control Panel is 1 or above.
- 2 Check speaker cable.
- 3 Replace speaker.
- 4 Replace logic board. Retain customer's SIMMs.

Sound from external video source does not record or play through speakers

- 1 Verify that audio cable connects sound source to sound input port when using S-video.
- 2 Check speaker cable.
- 3 Replace speaker.
- 4 Replace logic board. Retain customer's SIMMs.





Take Apart

Centris 660AV/Quadra 660AV





Top Cover

No preliminary steps are required before you begin this procedure.

- 1 Press up on the tabs at the back of the top cover.
- 2 Tilt the back of the top cover and remove the top cover.

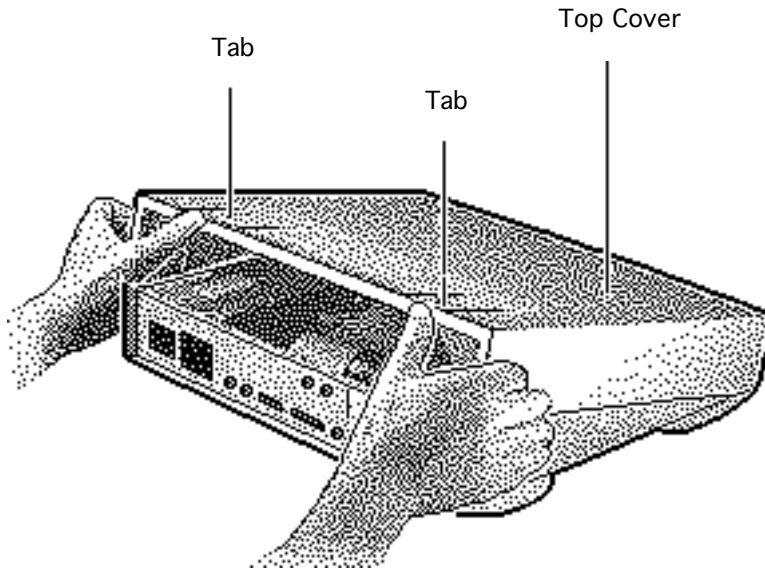



Power Supply

Before you begin, do the following:

- remove the top cover.
- Review the ESD precautions in Bulletins/ Safety.

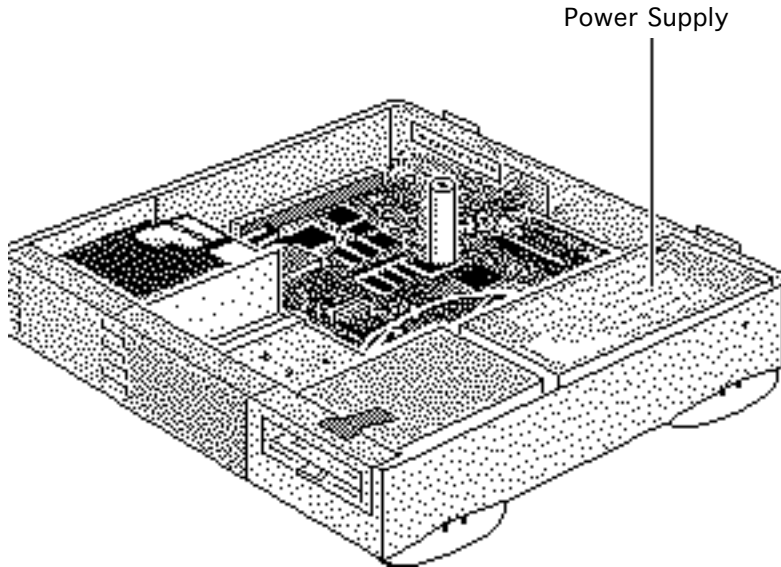



- 1 Remove the screw that secures the power supply.

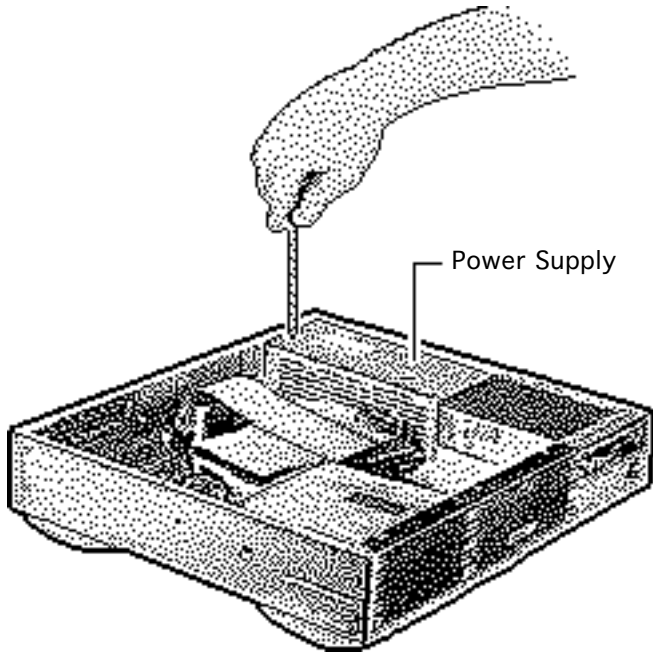

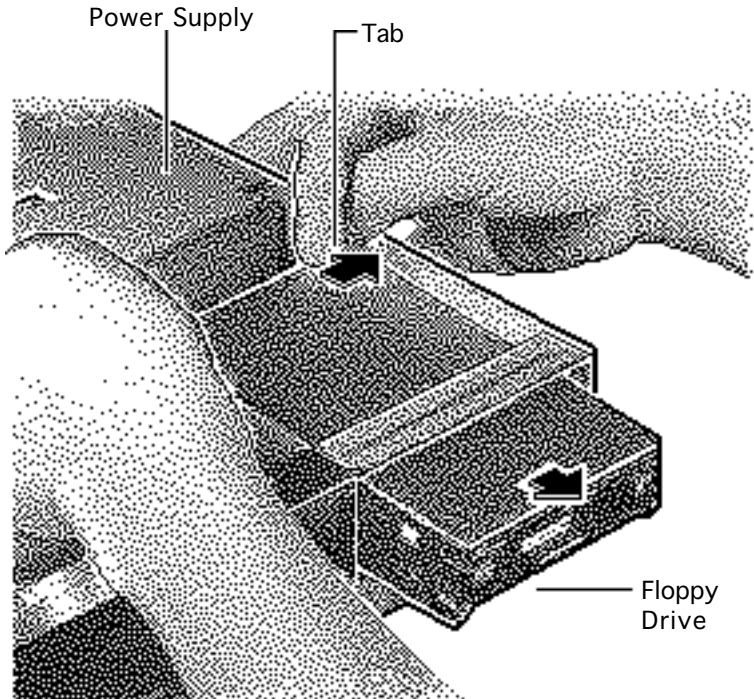

- 2 For easier access to the power supply, release the floppy drive mounting tabs. Slide the floppy drive forward a few inches.





CD-ROM Audio Cable

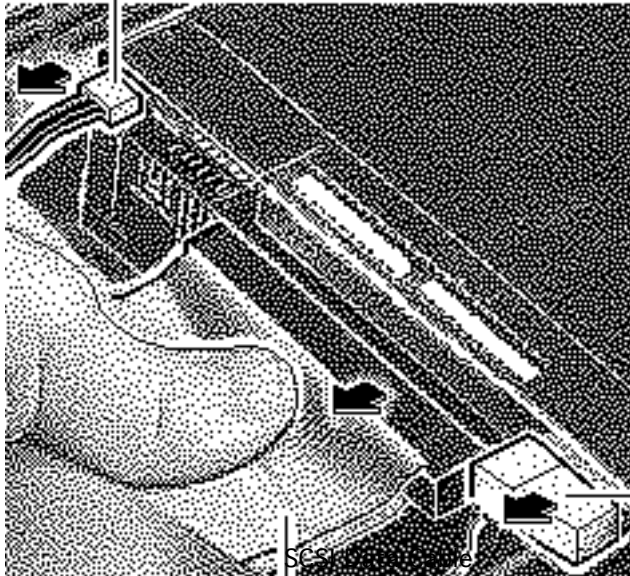

CD-ROM Drive Power Cable

- 3 If a CD-ROM drive is present, disconnect the SCSI data cable and CD-ROM drive power cable from the CD-ROM drive.
- 4 Disconnect the CD-ROM audio cable.





- 5 Remove the CD-ROM drive EMI shield.

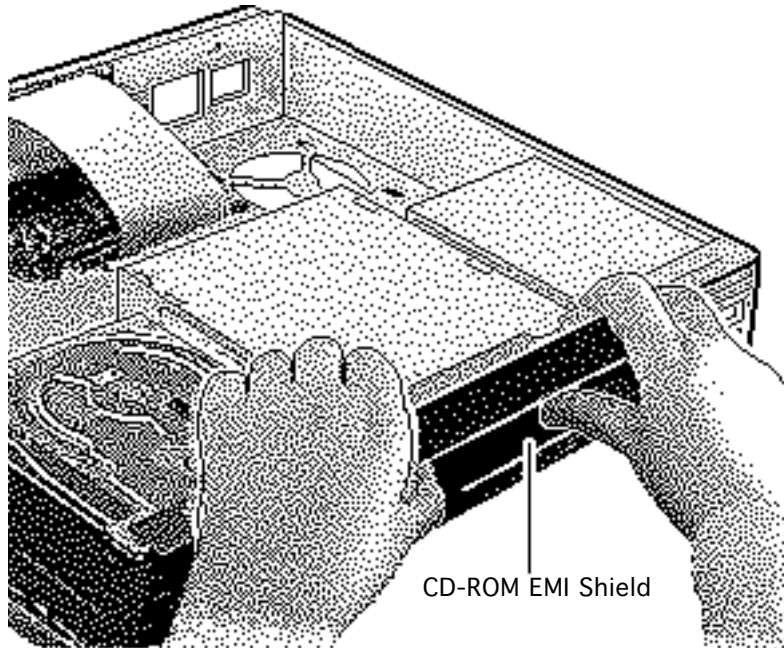



- 6 Press up on the tab and slide out the CD-ROM drive.

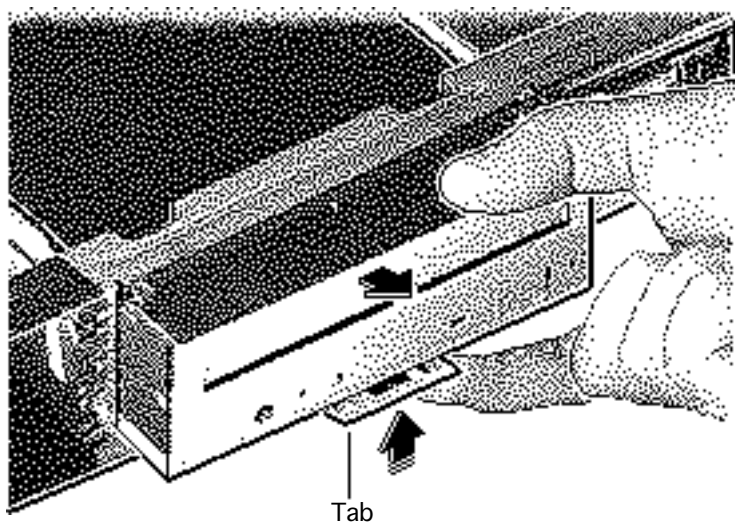

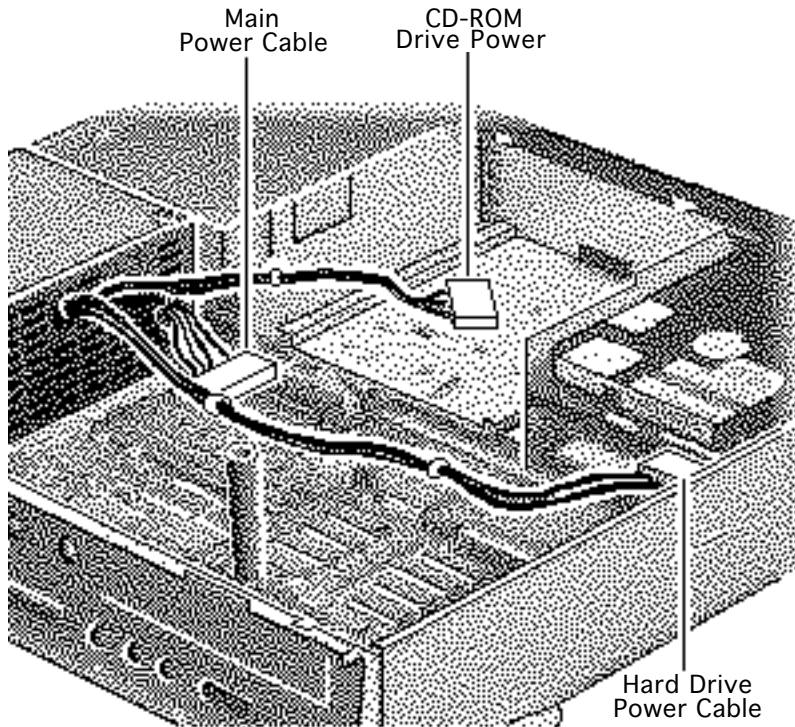

- 7 Disconnect these power supply cables:
- Main power cable from the logic board
 - Hard drive power cable from the hard drive
 - CD-ROM drive power cable from the CD-ROM drive (if installed)





- 8 Slide the power supply forward slightly.

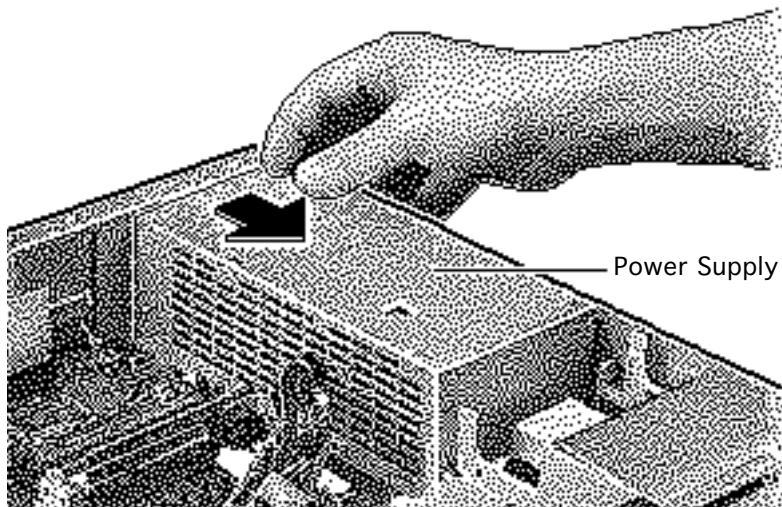



- 9 Tilt the front of the power supply and lift it out of the computer.

Replacement Note: Move the floppy drive forward. Press the actuator toward the back of the computer to properly seat the power switch in the actuator.

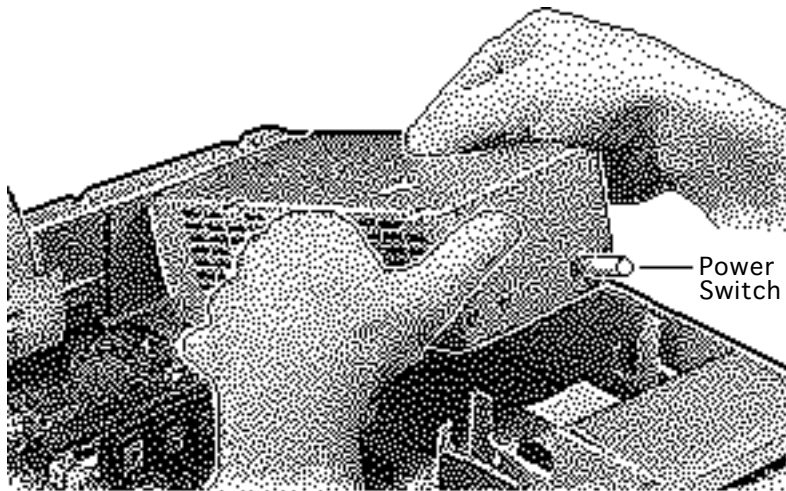



Logic Board

Before you begin, do the following:

- Remove the top cover
- Remove the Power supply
- Review the ESD precautions in Bulletins/ Safety.

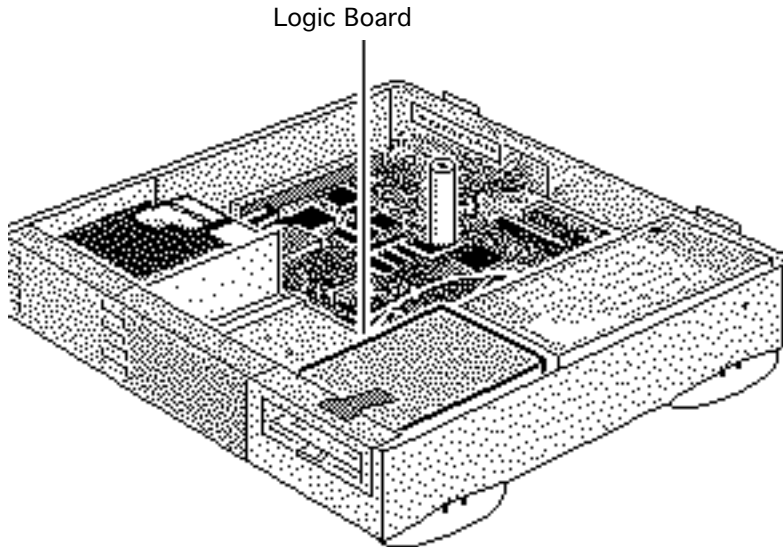



Standoff with Internal Screw

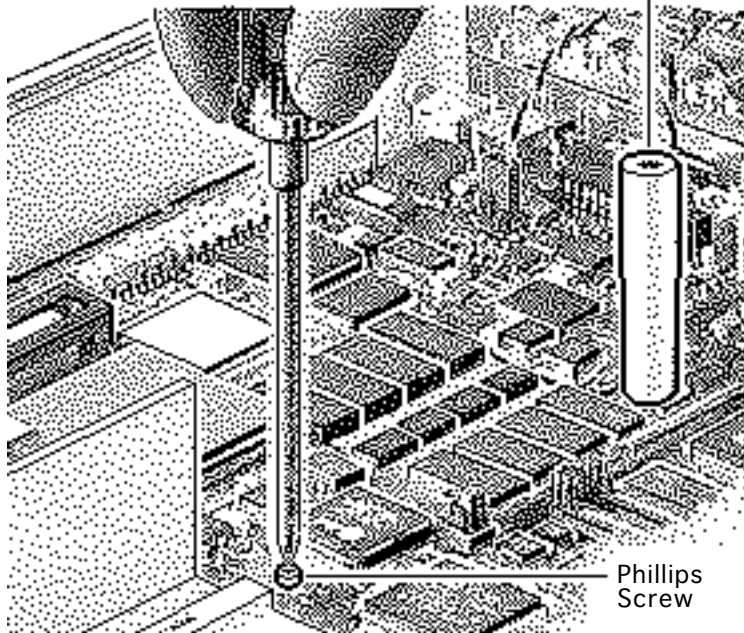

Phillips
Screw

Note: The logic board is secured with two screws.

- 1 Using a long Phillips screwdriver, remove the screw from the center of the standoff.
- 2 Remove the standoff.
- 3 Remove the Phillips screw from the front edge of the logic board.



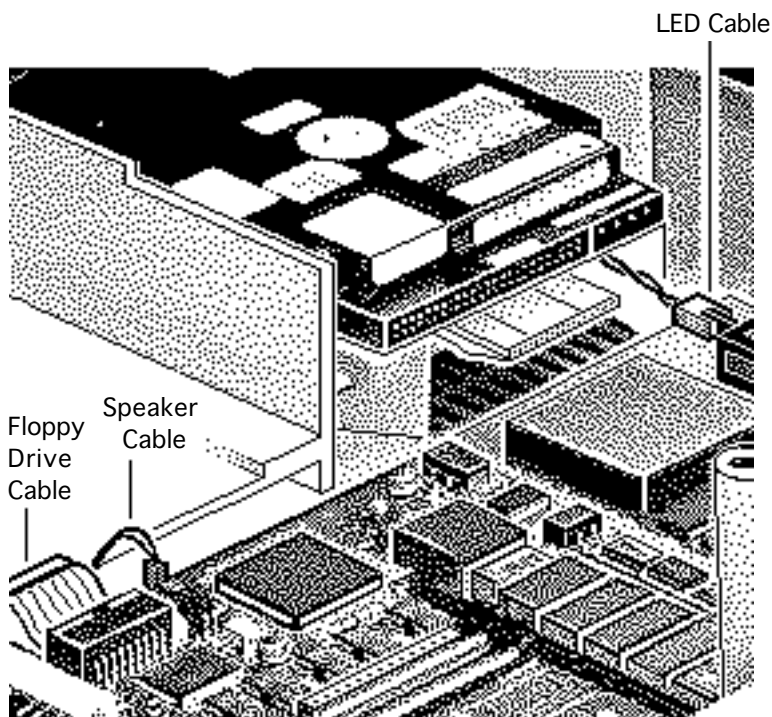

- 4 Disconnect these cables from the front edge of the logic board:
 - Floppy drive cable
 - Speaker cable
 - LED cable
 - CD-ROM audio cable (if present)
- 5 **Note:** Lift the front edge of the logic board to make removing the floppy drive cable easier.



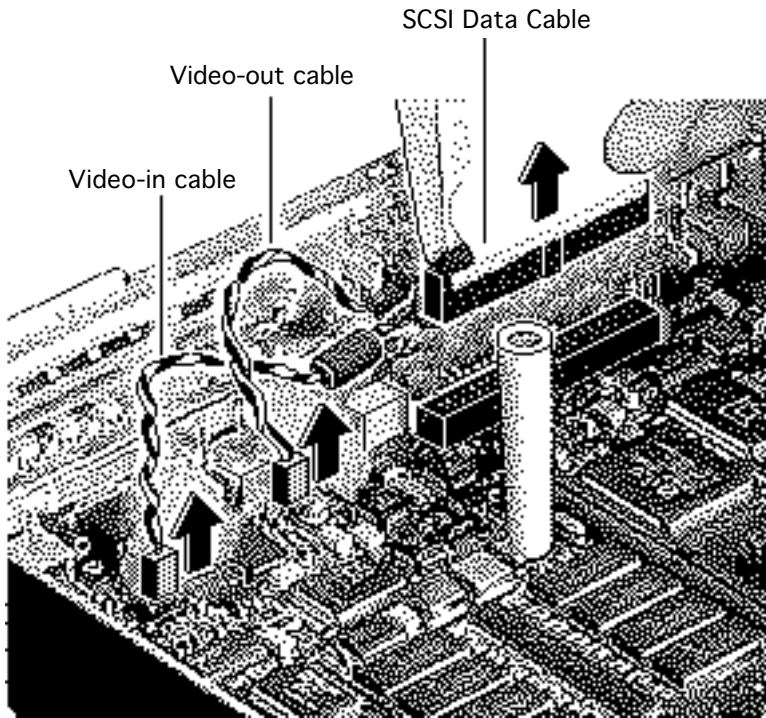

- 6 Disconnect these cables from the back edge of the logic board:
- Video-out cable
 - Video-in cable
 - SCSI data cable





- 7 Remove the EMI shield from the hard drive bay and from the CD-ROM bay, if the CD-ROM drive is installed.

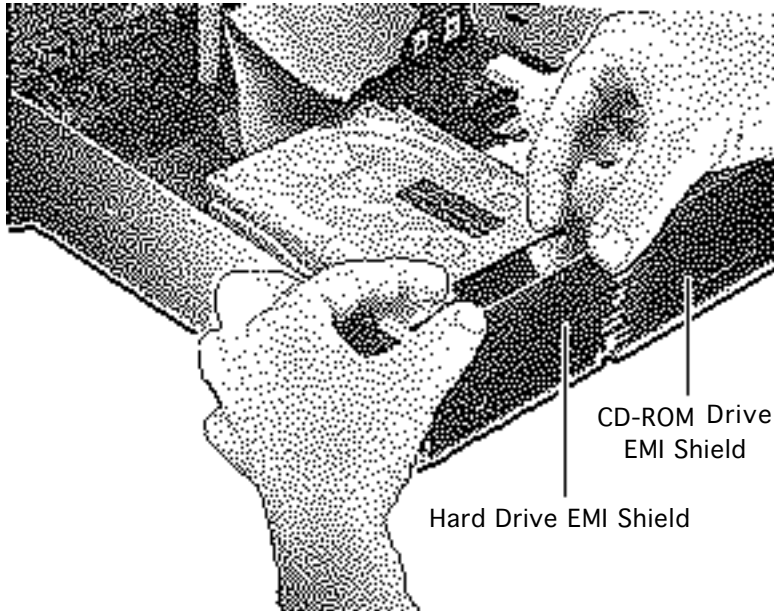

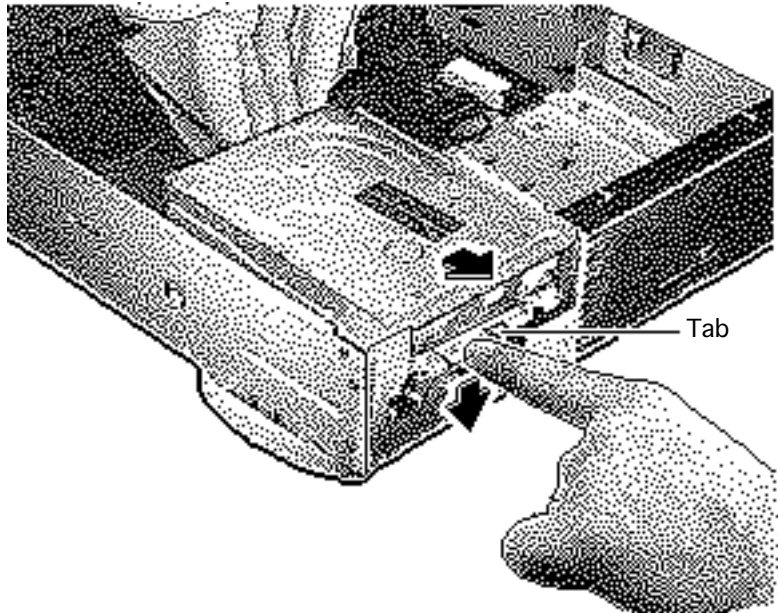

- 8 Release the tab to unlock the hard drive or CD-ROM, if installed.
- 9 Slide forward the hard drive and CD-ROM drive, if installed.





Logic Board

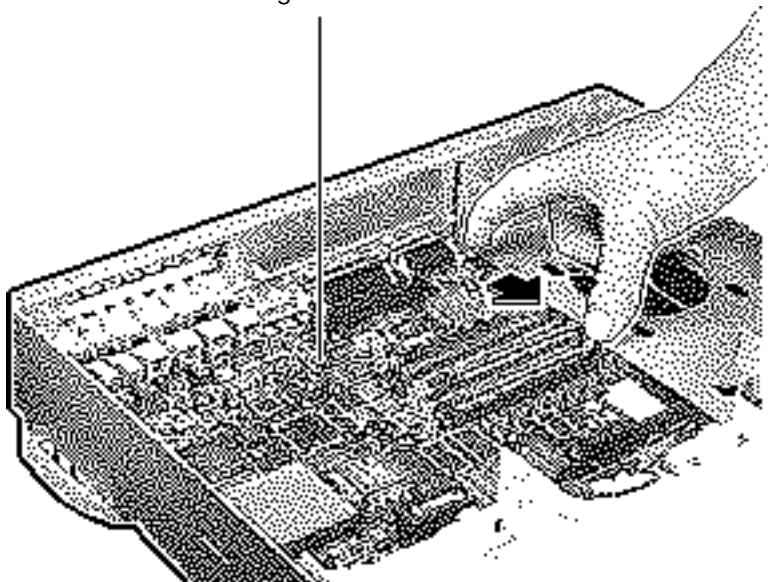

- 10 Slide the logic board about 1/2 inch toward the front of the computer.



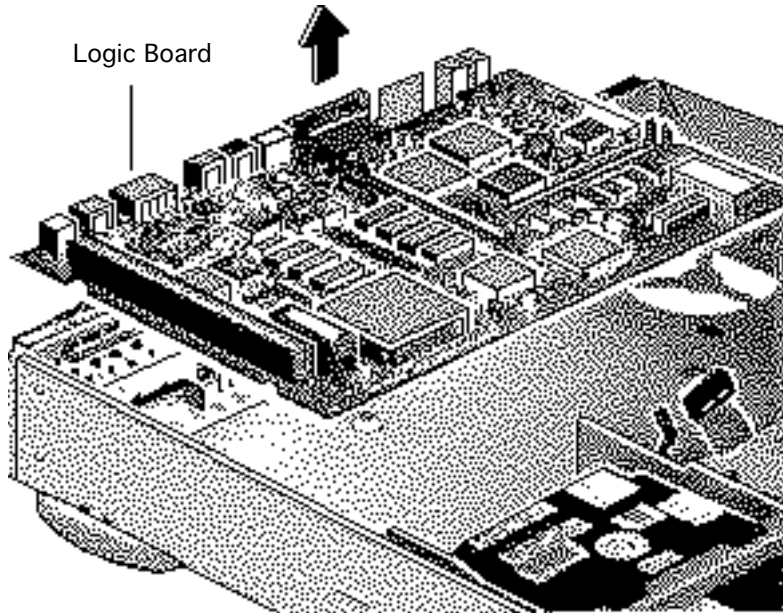

- 11 Remove the logic board.
- 12 **Replacement Note:** Slide the hard drive and optional CD-ROM drive forward a bit to allow room for the logic board. Connect the floppy drive cable before securing the logic board.





Floppy Drive

Floppy Drive

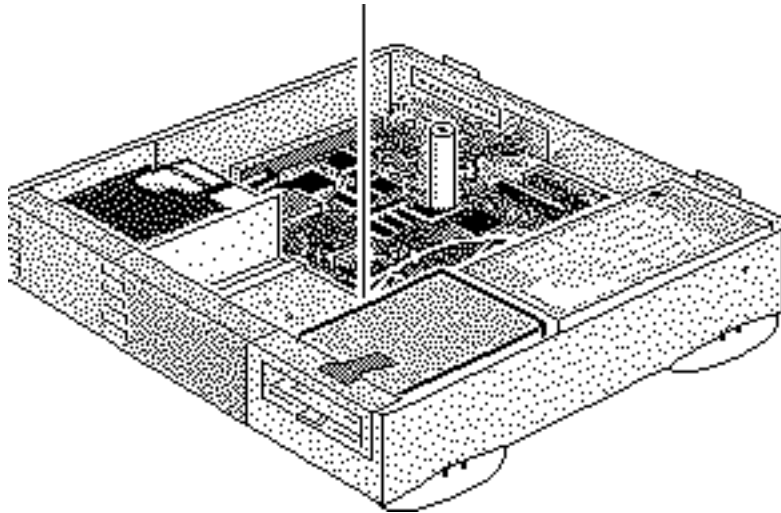

Before you begin:

- remove top cover.
- Review the ESD precautions in Bulletins/ Safety.



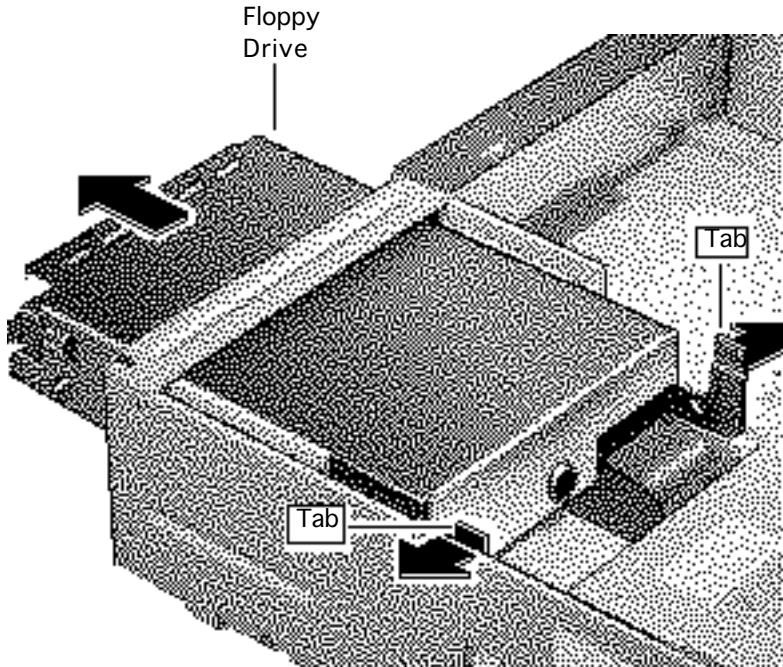

- 1 Press the tabs outwards and slide the floppy drive forward a few inches.



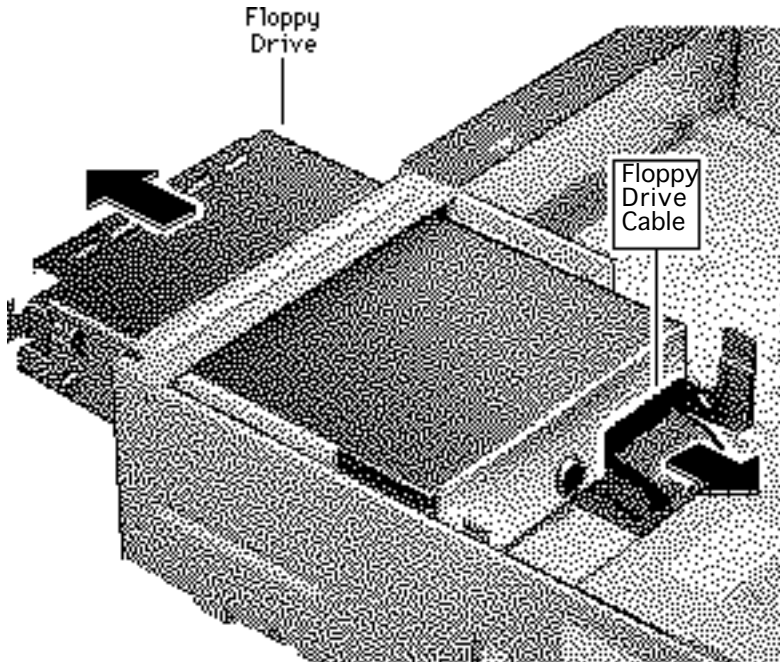

- 2 Disconnect the floppy drive cable.

Note: You can easily reach the floppy drive cable connector when the floppy drive is forward.

- 3 Slide out the floppy drive.





Hard Drive

Hard Drive

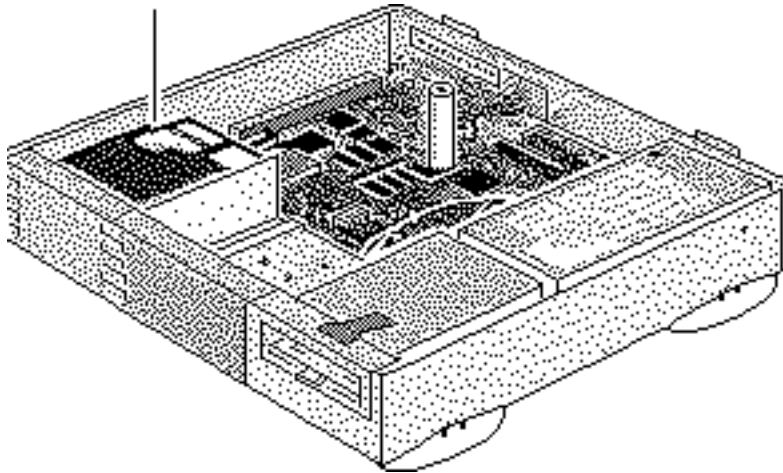

Before you begin:

- remove top cover.
- Review the ESD precautions in Bulletins/ Safety.



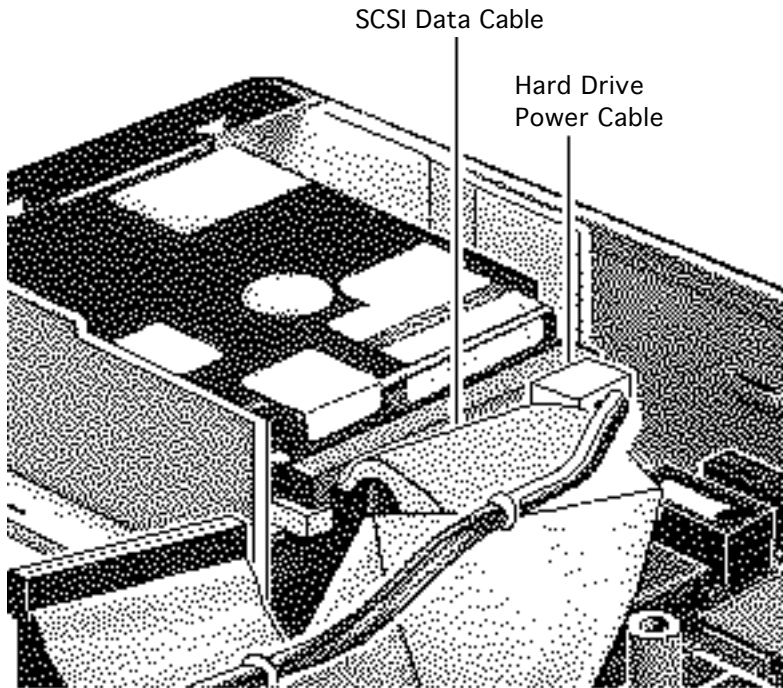

- 1 Disconnect the SCSI data and hard drive power cables from the hard drive.





- 2 Remove the hard drive EMI shield.

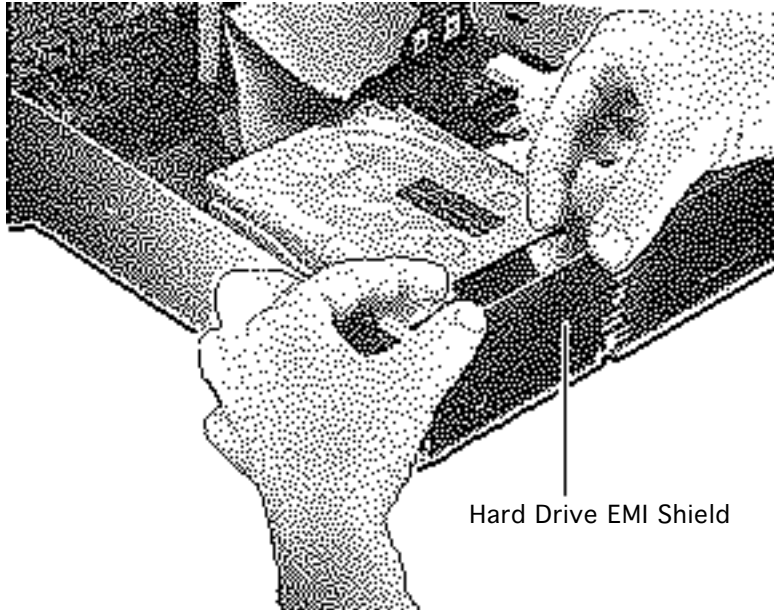

Hard Drive EMI Shield





- 3 Press down on the tab and slide out the hard drive.

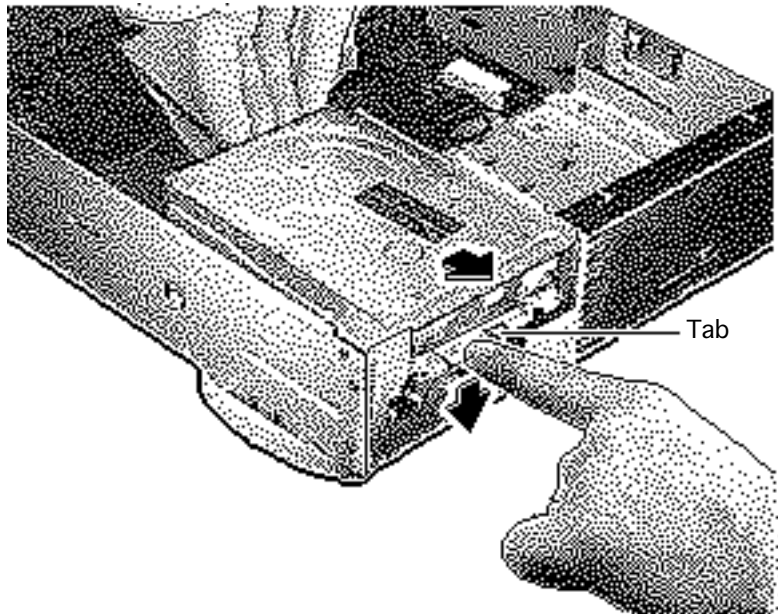



CD-ROM Drive

Before you begin:

- remove the top cover.
- Review the ESD precautions in Bulletins/ Safety.

CD-ROM Drive

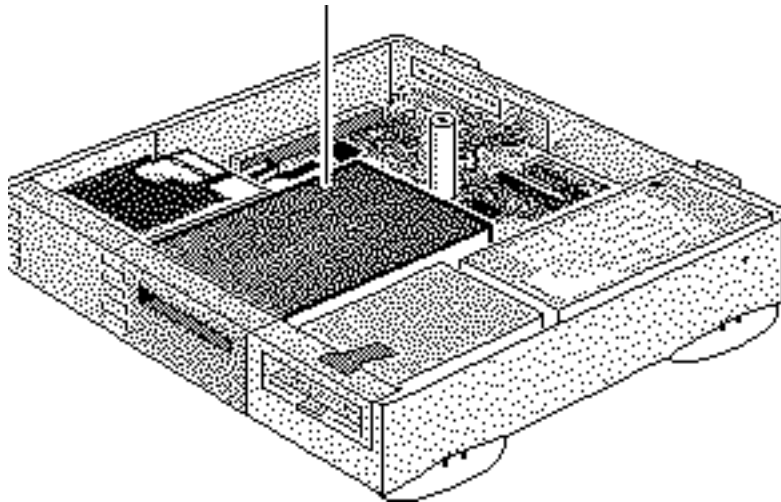



CD-ROM Audio Cable

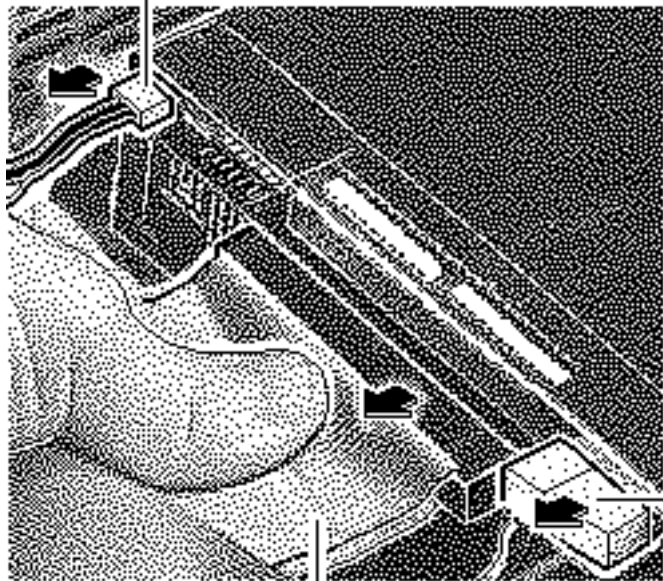

SCSI Data Cable

CD-ROM
Power
Cable

- 1 Disconnect the SCSI data cable and CD-ROM drive power cable from the CD-ROM drive.
- 2 Disconnect the CD-ROM audio cable.





- 3 Remove the CD-ROM drive EMI shield.

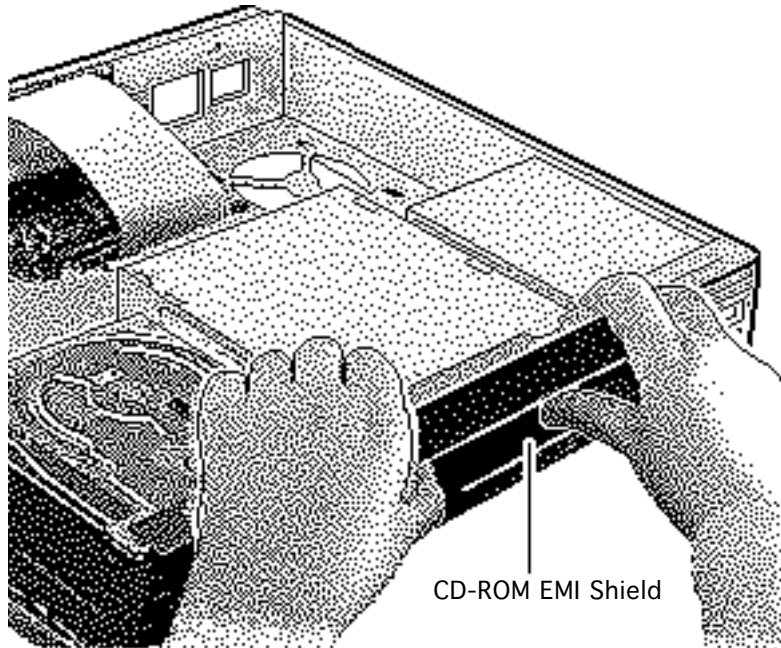



- 4 Press up on the tab and slide out the CD-ROM drive.

Replacement Note: Be sure to remove the CD-ROM drive from the carrier prior to returning the drive to Apple.

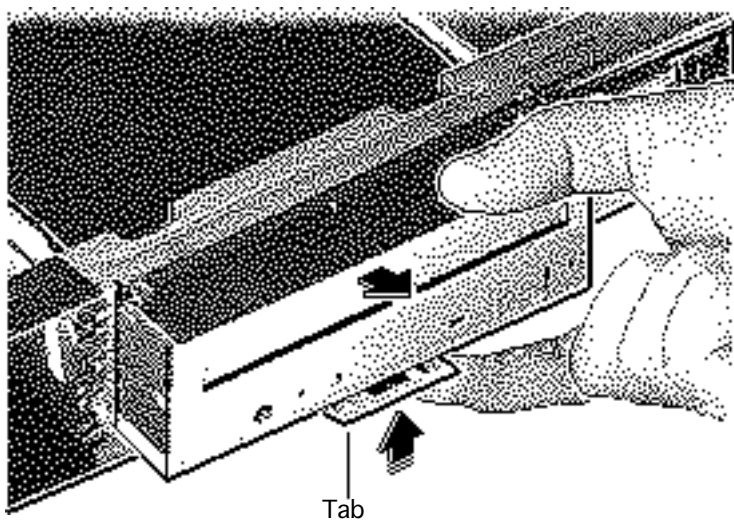



Internal Chassis and Speaker

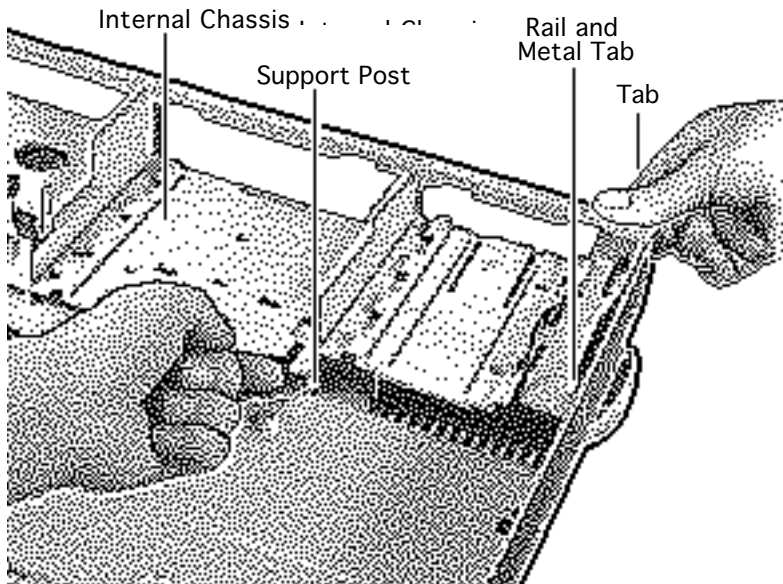

Before you begin: remove the following:

- Remove the top cover
- Remove the power supply
- Remove the floppy drive
- Remove the hard drive
- Remove the CD-ROM drive (if installed)
- Remove the logic board
- Review the ESD precautions in Bulletins/ Safety.

Note: The chassis is secured to the bottom cover by two





Internal Chassis

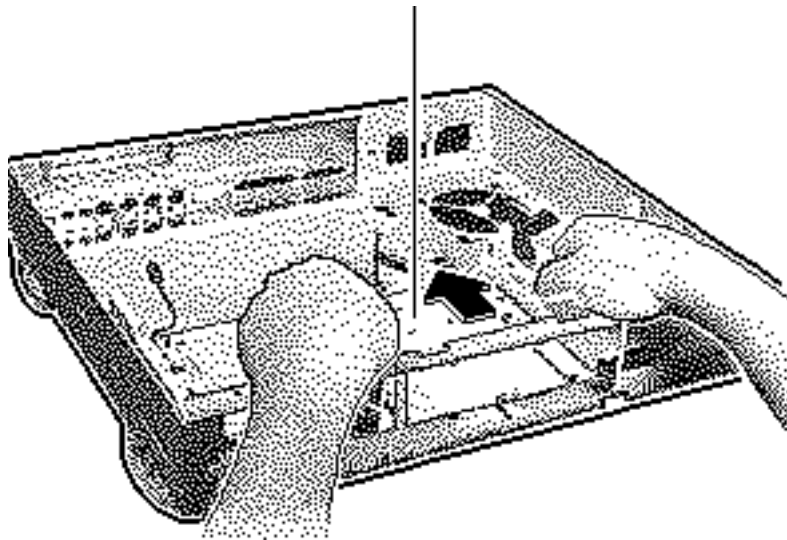

tabs at the front of the unit, two rail and tab sets at the sides of the unit, support posts at the back of the chassis, and hidden brackets that slide into the bottom cover.

- 1 Press up on one of the front tabs while lifting the support post.
- 2 Repeat this step on the other side until the internal chassis slides easily toward the back of the computer.
- 3 Press down and slide the chassis toward the back





of the computer.

- 4 Remove the chassis.

Note: The LED cable, floppy drive cable, speaker and speaker cable are not shipped with the replacement internal chassis.



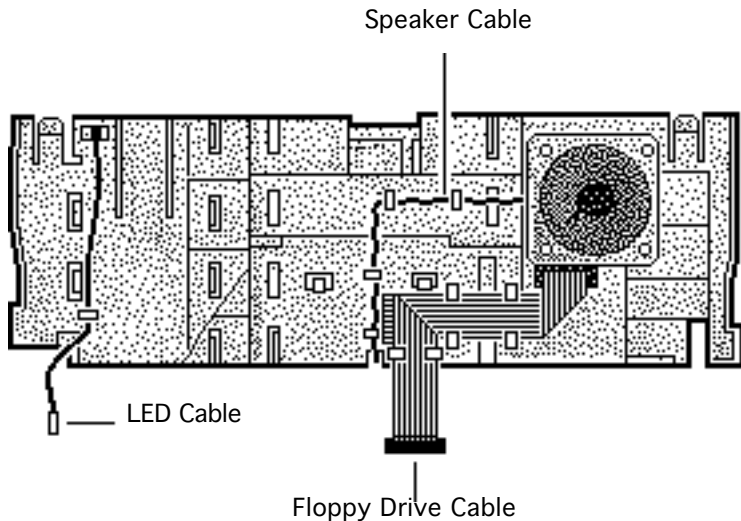

- 5 Turn the chassis over.
- 6 Remove the floppy drive cable and the LED cable.
- 7 Remove the speaker cable from its routing guides.



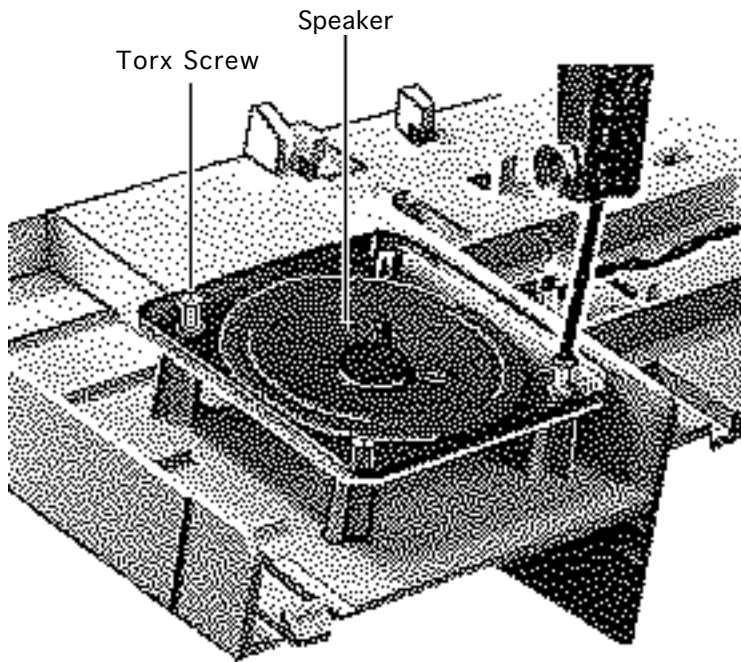

- 8 Remove the two torx screws from the speaker.
- 9 Lift out the speaker.



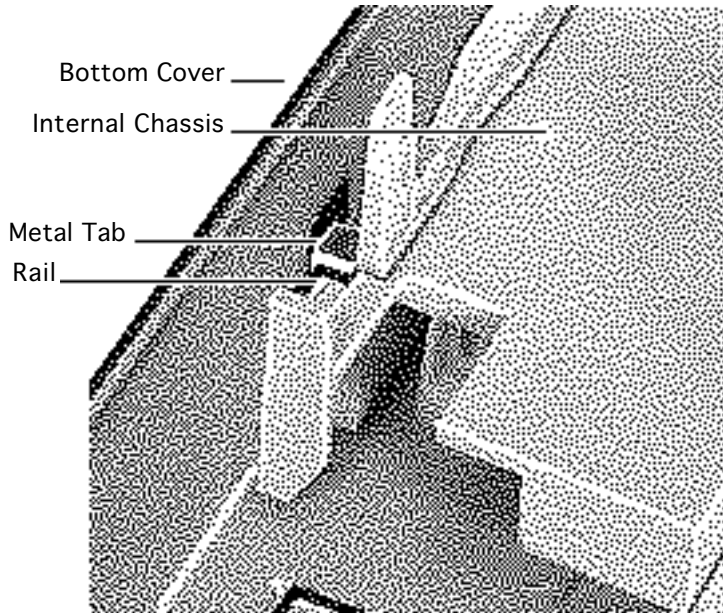

Replacement Note: Place the internal chassis on the floor of the bottom cover with the front of the chassis about 3/4 inch from the front of the cover. Align the side rails with the metal tabs and slide the rails under the metal tabs.





Replacement Note: After carefully aligning the side rails, push down firmly on the chassis and slide it toward the front of the unit. The tabs will snap into place.





Bottom Cover

Bottom Cover

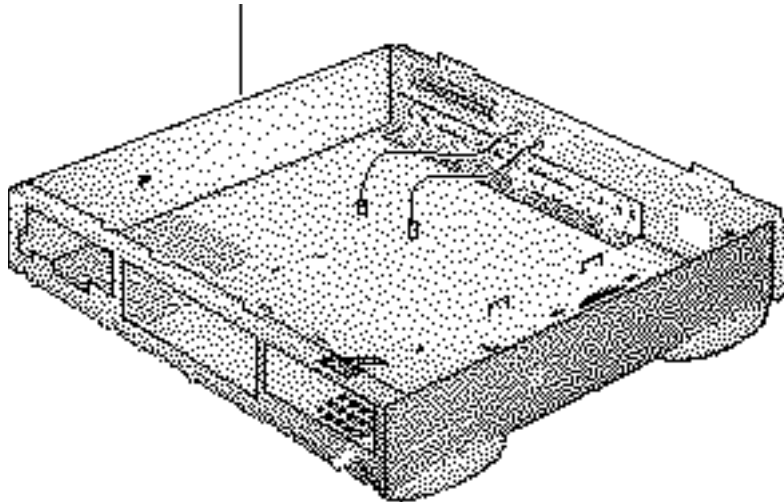

Before you begin: remove the following:

- Remove the top cover
- Remove the power supply
- Remove the floppy drive
- Remove the hard drive
- Remove the CD-ROM drive (if installed)
- Remove the logic board
- Remove the internal chassis
- Review the ESD precautions in Bulletins/ Safety



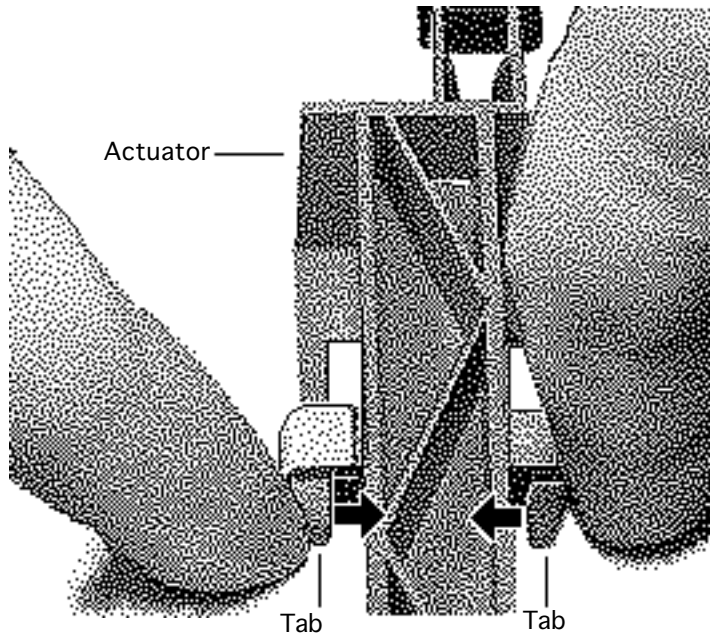

- 1 Shift the actuator toward the back of the unit.
- 2 Squeeze together the tabs on the shaft of the actuator.
- 3 Remove the actuator.





Insulator Sheet

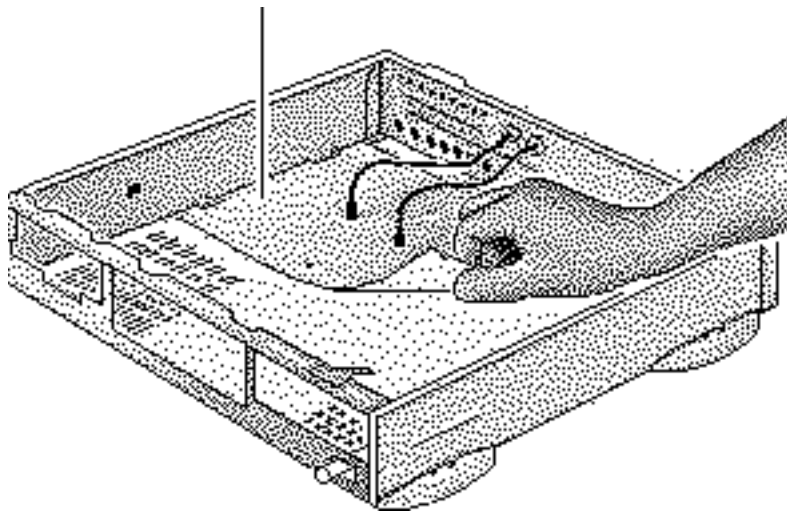

- 4 Lift out the insulator sheet.

Replacement Note:

There is only one correct position for the insulator sheet. Match the notches on the sides of the insulator sheet with the corresponding metal stops.



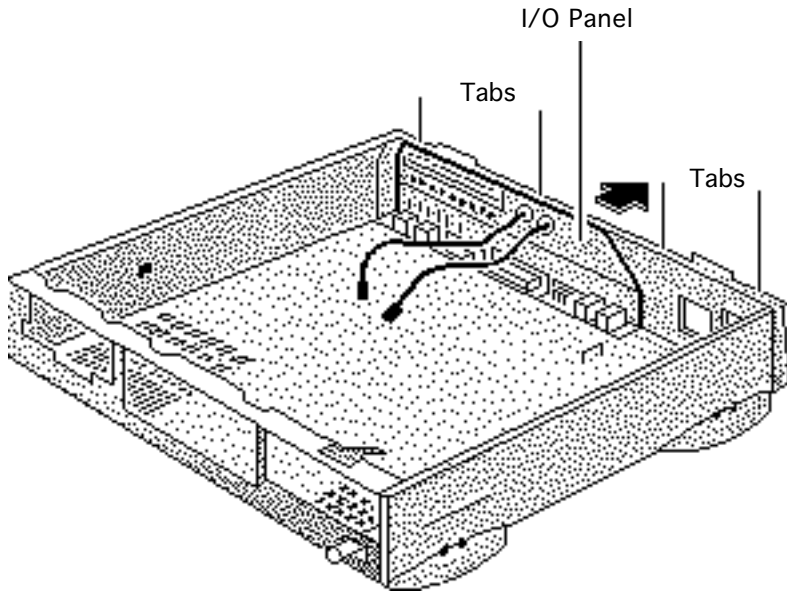

- 5 Using a screwdriver, release the tabs on the upper-rear edge of the bottom cover.
- 6 Push out the I/O panel.





Additional Procedures

Centris 660 AV/Quadra 660AV





Battery Verification

Battery

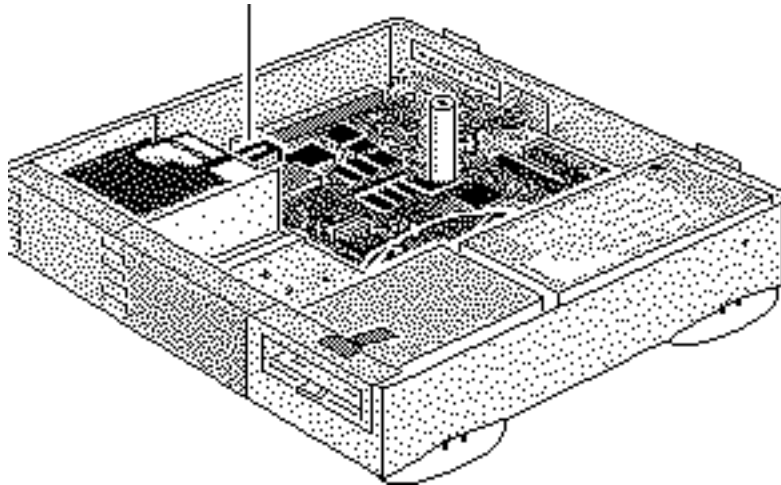

Before you begin do the following:

- Remove the top cover.

Warning: If handled or discarded improperly, the lithium battery in the computer could explode. Review battery-handling and disposal instructions in Bulletins/Safety.

- Review the ESD precautions in Bulletins/Safety.



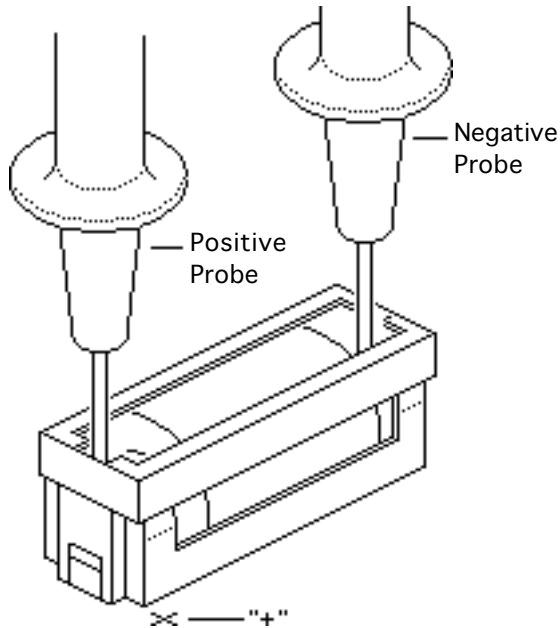

- 1 Set the voltmeter to the 10 volts DC scale.
- 2 Hold the positive probe of the voltmeter to the positive end of the battery (marked “+” on the logic board) and the negative probe to the negative end of the battery.
- 3 If the battery voltage is below 3.2 volts, replace the battery. Refer to “Battery Replacement” in this chapter.





Battery Replacement

Battery

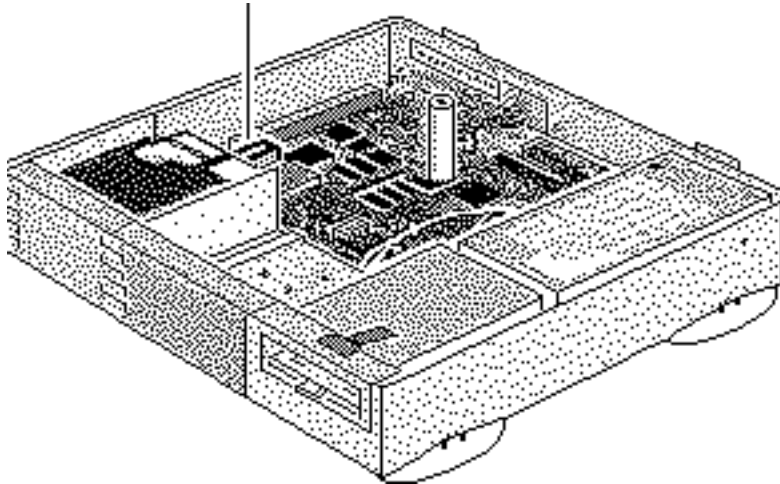

Before you begin do the following:

- Remove the top cover.

Warning: If handled or discarded improperly, the lithium battery in the computer could explode. Review battery-handling and disposal instructions in Bulletins/Safety.

- Review the ESD precautions in Bulletins/Safety.





- 1 Using a small flat-blade screwdriver, pry open the latch at the end of the battery holder and lift off the cover.

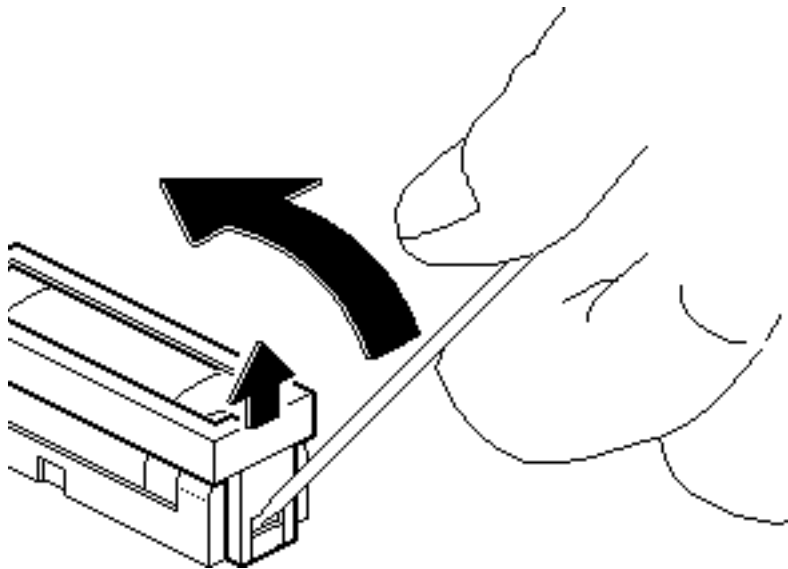

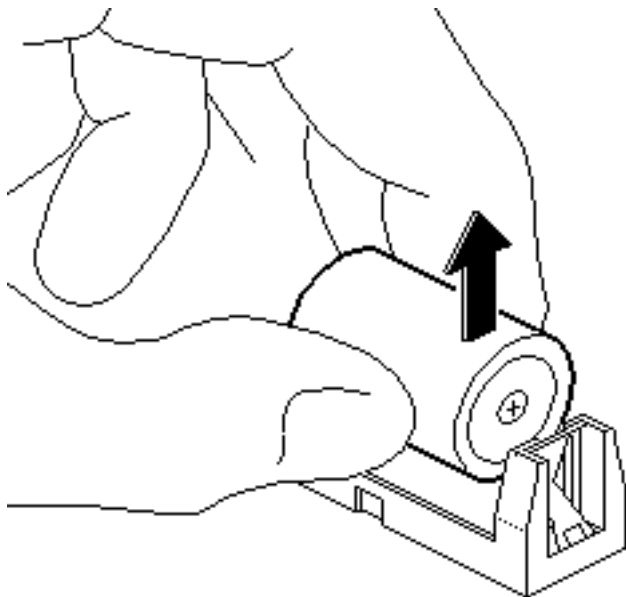

- 2 Grasp the battery and remove it from the holder.
- 3 Return the battery to Apple for proper disposal. For battery packaging and labeling instructions, refer to the safety information in Bulletins/Safety.





Upgrades

Centris 660AV/Quadra 660AV





Expansion Cards

Expansion Card Slot

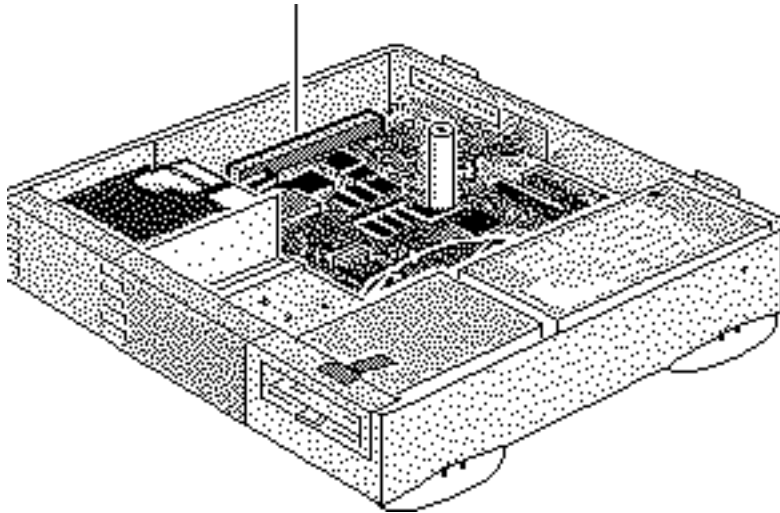

Before you begin, do the following:

- Remove the top cover.
- Review the ESD precautions in Bulletins/ Safety.



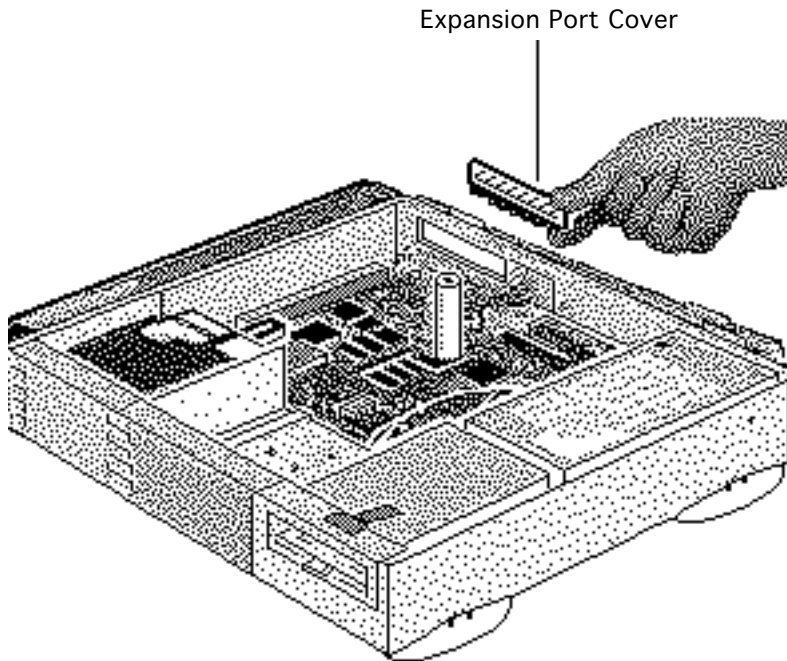

- 1 Remove the expansion port cover from the back panel.



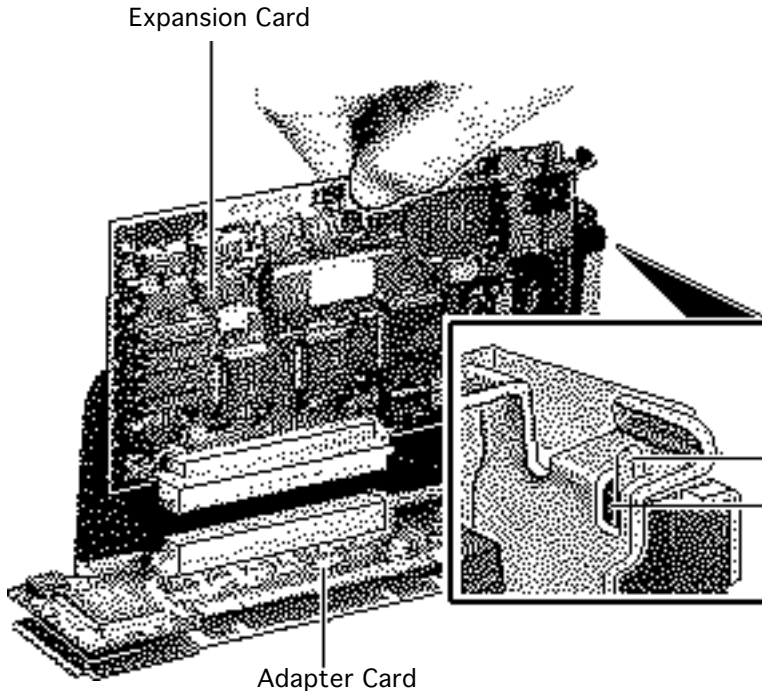

- 2 Loosely connect the expansion card connector to the adapter card connector.
Note: Be sure to fit the adapter card pin into the expansion card hole.
- 3 Gently press the connectors together.



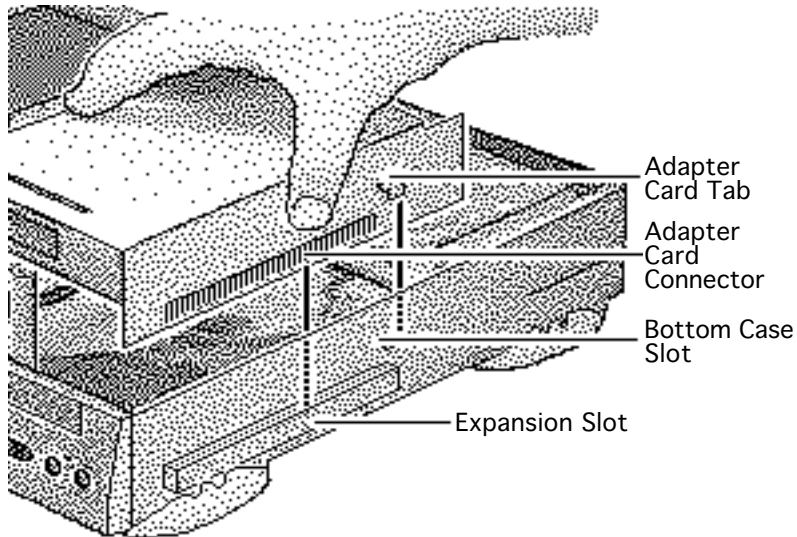

- 4 Insert the connector on the bottom of the adapter card into the expansion slot.

Note: Make sure that the tab on the side of the adapter card slides into the slot on the side of the bottom case.





- 5 Attach the thumbscrews.

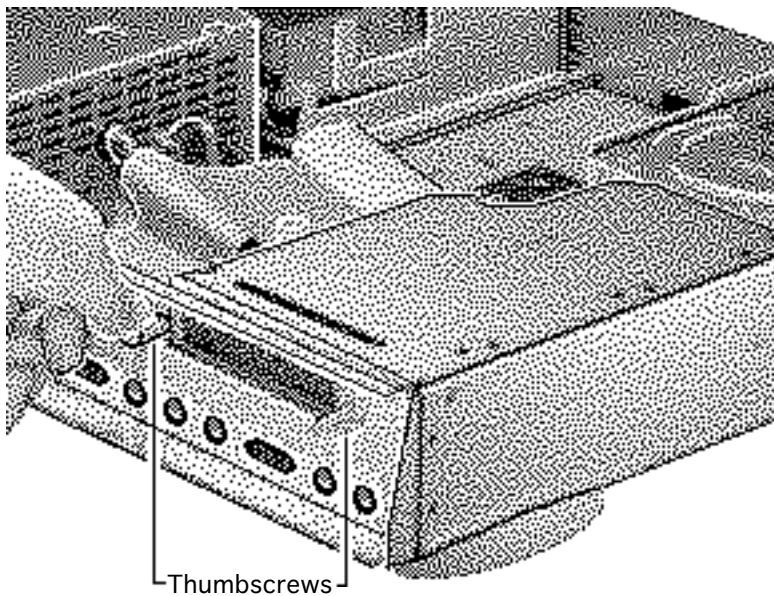



CD-ROM Drive Upgrade

Before you begin, do the following:

- Remove the top cover.
- Review the ESD precautions in Bulletins/Safety.

CD-ROM Drive Bay

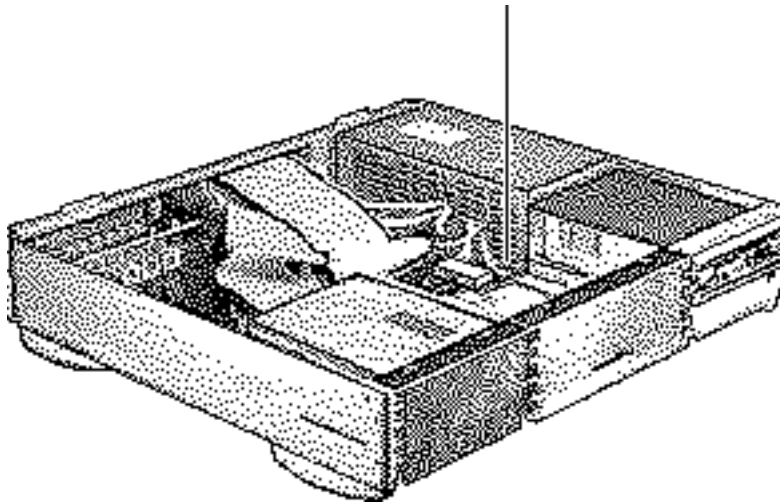



- 1 Remove the blank CD-ROM drive bezel from the top cover.
- 2 Install the slotted CD-ROM drive bezel in the top cover.

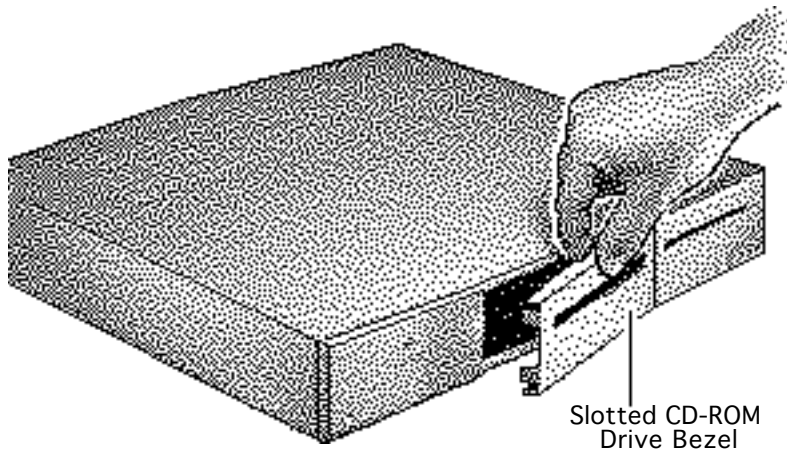



- 3 Pry off the metal 5.25" drive bay shield.

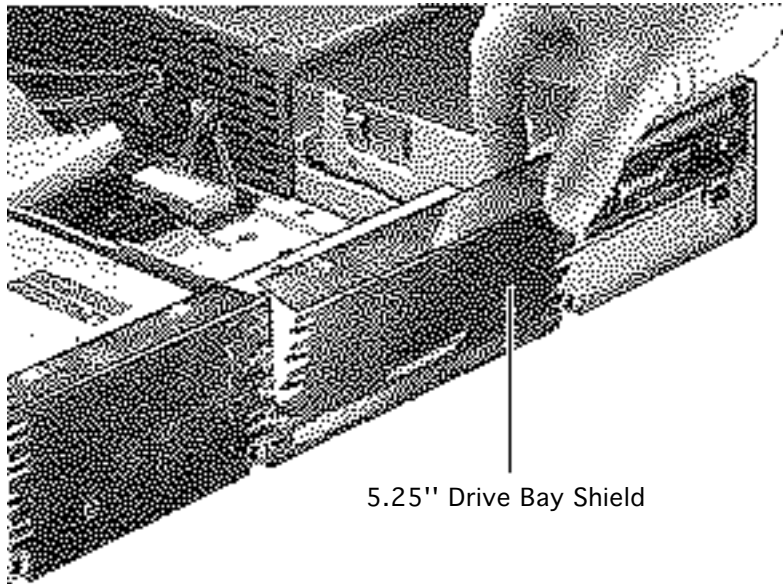

5.25" Drive Bay Shield





CD-ROM Drive Carrier

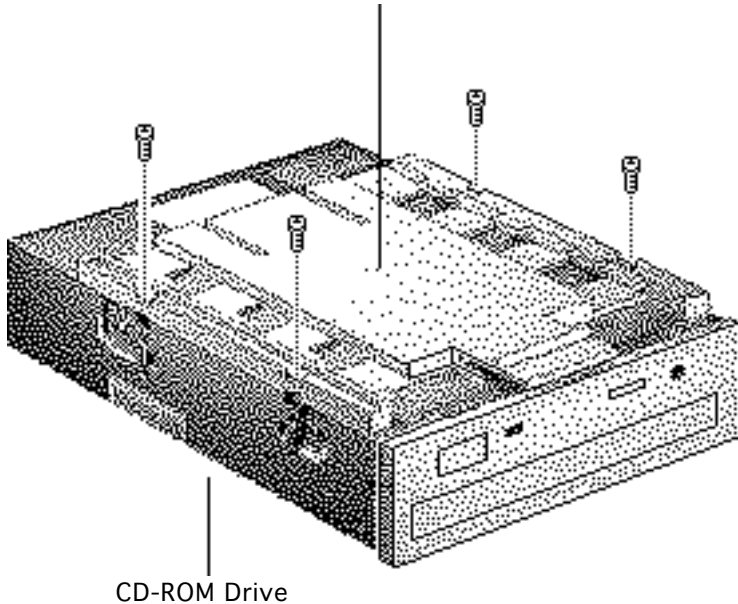

- 4 Attach the CD-ROM drive carrier to the CD-ROM drive with four Phillips screws.



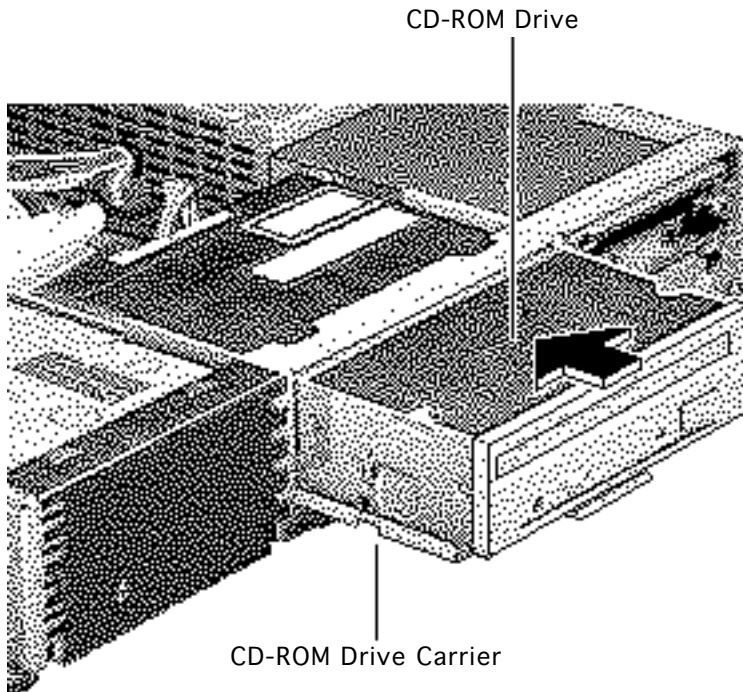

- 5 Push in the CD-ROM drive and carrier.



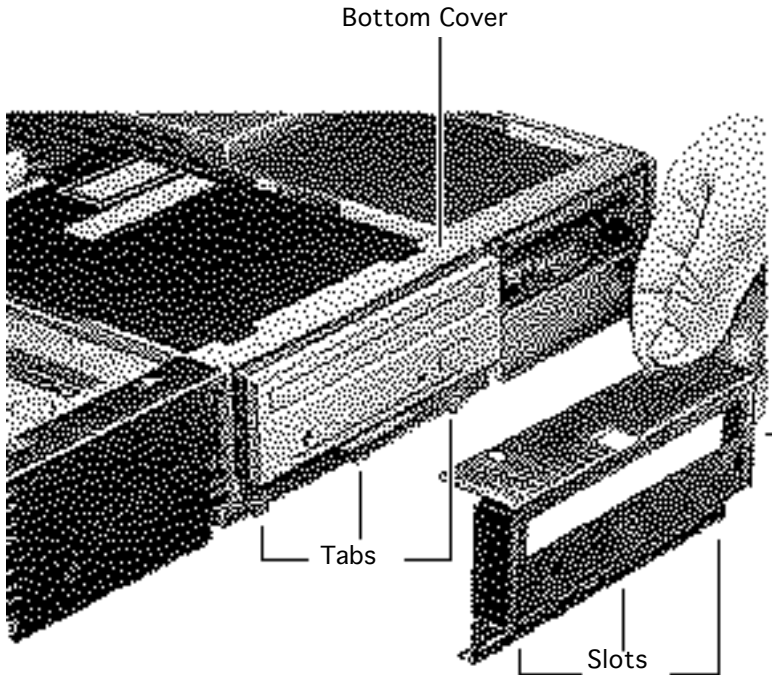

- 6 Align the slots at the lower edge of the CD-ROM shield with the tabs on the bottom cover.
- 7 Swing up the CD-ROM shield until it snaps securely onto the bottom cover.



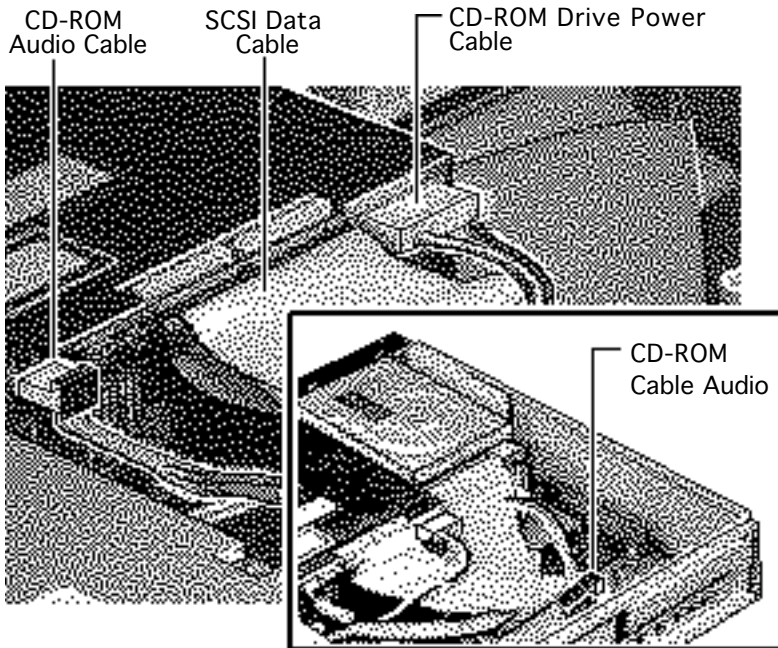

- 8 Connect these cables from the power supply to the CD-ROM drive:
 - CD-ROM audio cable
 - SCSI data cable
 - CD-ROM drive power cable
- 9 Connect the other end of the CD-ROM audio cable to the logic board.





Power Mac Upgrade

No preliminary steps are required before you begin this procedure.

The Centris 660AV and Quadra 660AV can be upgraded to a Power Macintosh 6100/60 or Power Macintosh 6100/60AV. For upgrade instructions, refer to Additional Procedures in the Power Macintosh 6100 manual.

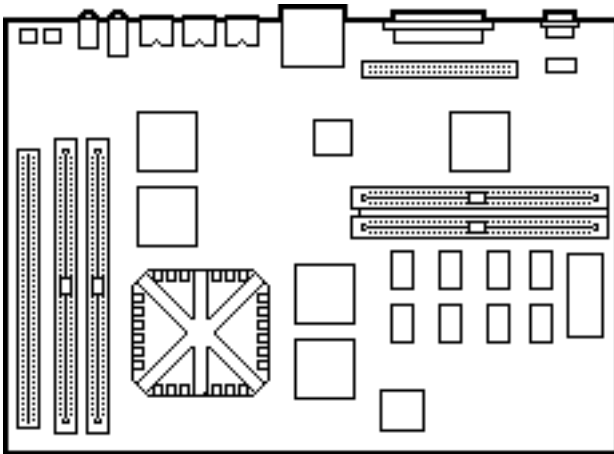



Centris 660AV/Quadra 660AV

Parts





Actuator, On/Off

922-0357

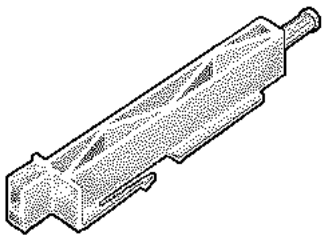



Battery, Lithium, without Leads

742-0011





Bezel, Blank

922-0358

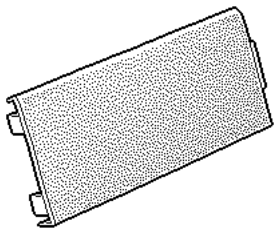



Bezel, CD, ROM Drive

922-0355

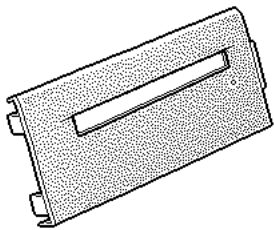



Board, Logic, 4 MB, 25 MHz, Centris/Quadra 660AV

661-1704

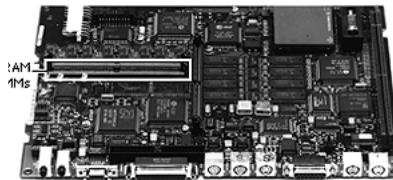



Brace, Chassis Support

922-0396

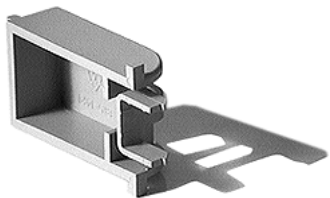



Cable, British Power Cord

590-0091





Cable, AC Power Cord, International

590-0094





Cable, AC Power Cord

590-0760





Cable, CD-ROM, Audio

922-0842





Cable, Composite Video

922-0870





Cable, Floppy Drive

922-0351

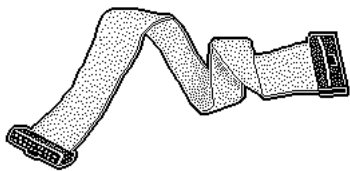



Cable Kit, SCSI Select

076-0130





Cable, LED, Power

922-0354

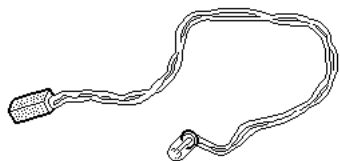



Cable, Power, 110 V, Smoke

590-0380





Cable, SCSI Drive (Replaced by 922-0804)

922-0352

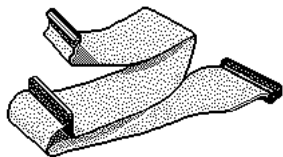



Cable, SCSI Drive, Pkg. of 5

922-0804

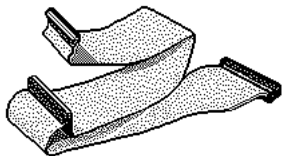



Carrier, 1.4 MB Apple SuperDrive

805-0961

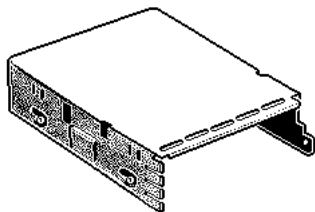



Carrier, CD-ROM Drive

922-0850

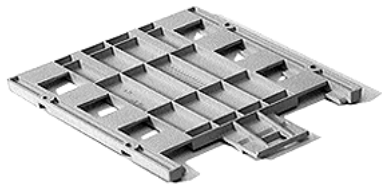



Carrier, Hard Drive

922-1806

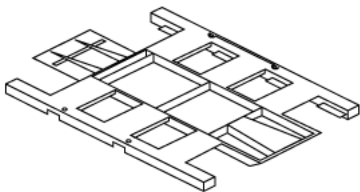



CD-ROM Drive, Apple CD 300+, Trayloading

661-0222





CD-ROM Drive, Apple CD 300, Caddy Loading

661-0023





Chassis, Drive Assembly

922-0359

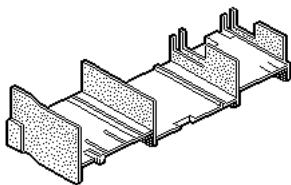



Clip, ESD Floppy (Bag of 10), Macintosh Centris 660AV

922-0879





Column (Top Cover Support)

922-0356

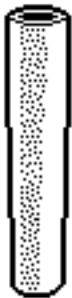



Cover, Top, Manual Insert Floppy

922-0545

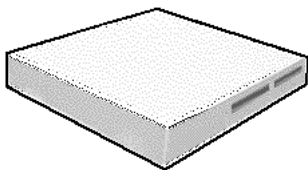



Feet, Enclosure, Pkg. of 4

922-0862





Floppy Drive, Apple SuperDrive, 1.4 MB, Manual Insert

661-0121

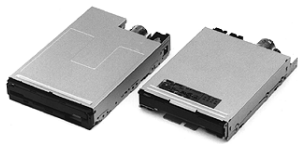

**Hard Drive, 230 MB, SCSI, 3.5" (Discontinued)****661-1637**

This part has been discontinued. For replacement of parts covered under warranty or AppleCare®, order 661-1750. For replacement of out-of-warranty parts, refer to the parts list in the Service Source manual for the product you are repairing.





Hard Drive, 250 MB, SCSI, 3.5"

661-0890

Top



Bottom



This drive is one of the recommended replacement choices for an out-of-warranty hard drive that's been discontinued. This drive may not be exchanged for the failed, out-of-warranty drive, but must be ordered as stock.



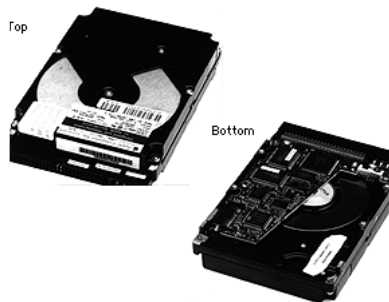

Hard Drive, 350 MB, SCSI, 3.5"

661-0182

This drive is one of the recommended replacement choices for an out-of-warranty hard drive that's been discontinued. This drive may not be exchanged for the failed, out-of-warranty drive, but must be ordered as stock.



**Hard Drive, 500 MB, SCSI, 3.5"****661-0219**

This drive is one of the recommended replacement choices for an out-of-warranty hard drive that's been discontinued. This drive may not be exchanged for the failed, out-of-warranty drive, but must be ordered as stock. All replacement drives will be shipped without carriers.

Cable Return Requirements: Return the defective drive without cables.

Carrier Return Requirements: Return the drive without a carrier.

Special Packaging Requirements: Pkg: #602-0282
Surcharge: \$150.00

Failure to comply with these requirements may result in a packaging noncompliance surcharge. Please refer to Service Price Pages for ordering and pricing information.



**Hard Drive, 500 MB, SCSI, 3.5"****661-0974**

This drive is one of the recommended replacement choices for an out-of-warranty hard drive that's been discontinued. This drive may not be exchanged for the failed, out-of-warranty drive, but must be ordered as stock.



**Hard Drive, 800 MB, SCSI, 3.5"****661-1102**

This drive is one of the recommended replacement choices for an out-of-warranty hard drive that's been discontinued. This drive may not be exchanged for the failed, out-of-warranty drive, but must be ordered as stock.



**Hard Drive, 80 MB, SCSI, 3.5" (Discontinued)****661-0212**

This part has been discontinued. For replacement of parts covered under warranty or AppleCare®, order 661-1750. For replacement of out-of-warranty parts, refer to the parts list in the Service Source manual for the product you are repairing.



**Hard Drive, 500 MB, SCSI, 3.5", In-Warranty Exchange ONLY****661-1750**

Only order this part number when exchanging a failed hard drive that meets both of the following conditions: 1) the failed hard drive is covered under warranty or AppleCare®, and 2) the like-for-like replacement hard drive has been discontinued.

Apple has made every effort to maintain LED support in its exchange program; however, some drives no longer support an LED. We regret any inconvenience this may cause.



**Hard Drive, 160 MB, SCSI, 3.5" (Discontinued)****661-0214**

This part has been discontinued. For replacement of parts covered under warranty or AppleCare®, order 661-1750. For replacement of out-of-warranty parts, refer to the parts list in the Service Source manual for the product you are repairing.



**Hard Drive, 80 MB, SCSI, 3.5" (Discontinued)****661-0111**

This part has been discontinued. For replacement of parts covered under warranty or AppleCare®, order 661-1750. For replacement of out-of-warranty parts, refer to the parts list in the Service Source manual for the product you are repairing.





Hard Drive, 1 GB, SCSI, 3.5"

661-0228

This drive is one of the recommended replacement choices for an out-of-warranty hard drive that's been discontinued. This drive may not be exchanged for the failed, out-of-warranty drive, but must be ordered as stock.

All replacement drives will be shipped without carriers. Return the defective drive without cables, carrier, hard drive frame, LED cable, or SCSI select cable. Special Packaging Requirements: Pkg: #602-0282 Surcharge: \$150.00.

Failure to comply with these requirements may result in a packaging noncompliance surcharge. The drive warranty will be void and Apple will return the module to the service provider without repair if the drive bar code label, manufacturer identification label, Apple capacity or EPROM label, or labels that say "Warranty Void if Seal Broken" have been tampered with or removed.





Housing, Bottom (replaced by 922-0806)

922-0360

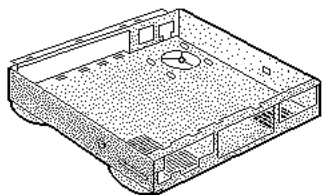



Housing, Bottom

922-0806

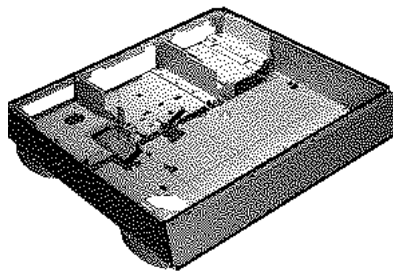



Housing, Top Cover Assembly

922-0368

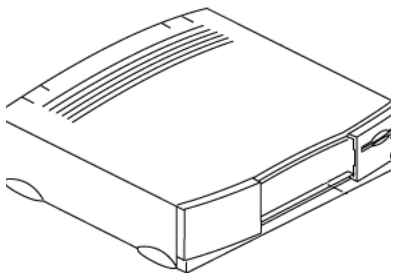



Insulator Sheet

922-0866

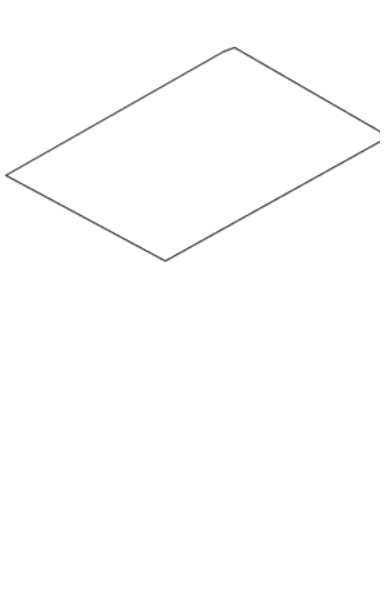



Keyboard, Apple Adjustable

661-0731



**Keyboard, AppleDesign (Discontinued and Replaced by 922-2832)****661-0310**

The US version of this keyboard must now be ordered as 922-2832. Orders are no longer accepted for 661-0310. Do not return this keyboard to Apple. The international versions of this keyboard (661-0310 B/D/F/E/S/T) are still valid part numbers and should be returned to Apple for replacement.





Keyboard, AppleDesign

922-2832





Keyboard, AppleDesign, British

B661-0310





Keyboard, AppleDesign, French Canadian

C661-0310





Keyboard, AppleDesign, French

F661-0310





Keyboard, AppleDesign, German

D661-0310





Keyboard, AppleDesign, Italian

T661-0310





Keyboard, AppleDesign, Spanish

E661-0310



**Keyboard, Apple Desktop Bus (replaced by 661-0603)****661-0337**

Internationally localized versions of this module may be ordered by utilizing P/Ns 661-0337B/D/F/T.
Keyboard is to be returned to Apple without the cable.





Keyboard, Apple Extended (Replaced by 661-0543)

661-0384

§





Keyboard II, Apple Extended

661-0543





Keyboard II, Apple

661-0603





Keypad, Apple Adjustable Int'l, w/Decimal Point (,)

661-0816





Keypad, Apple Adjustable Int'l, w/Decimal Point (.)

661-0817





Keypad, Apple Adjustable

661-0762





Label, Name Plate, Macintosh Quadra 660AV (Bag of 10)

922-0865





Label, Product ID (Bag of 10) Macintosh Centris 660AV, Europe

922-0878





Label, Product ID (Bag of 10) Macintosh Centris 660AV

922-0868





Label, Product ID, Quadra 660AV (Bag of 10)

922-0741





Microphone, Apple PlainTalk

922-0867

Use this microphone with Macintosh LC 475.





Mouse II, Apple Desktop Bus, Version A

661-0763



This module is replaced by part number 661-0104.



**Mouse II, Apple Desktop Bus, Version B****661-0104**

P/N 661-0104 and P/N 661-0763 are similar. To differentiate the two, check the connector at the end of the cable. P/N 661-0763 has a number printed on the connector; P/N 661-0104 has no number. The retainer for P/N 661-0104 is available with or without a small locking hole. There are two versions of the retainers with holes: version M, P/N 922-1242, and version L, P/N 922-1109. If the product label on the bottom of the mouse begins with “M,” and the retainer has a hole, order P/N 922-1242; if the product label begins with “L,” and the retainer has a hole, order P/N 922-1109. Note: The retainers are not interchangeable; be sure to order like for like.





Mouse, Apple DeskTop Bus (Replaced by 661-0763)

661-0338



Note: This module is replaced by Apple P/N 661-0104.





Mouse, Apple Desktop Bus (replaced by 661-0763)

661-0479



Note: This module is replaced by Apple P/N 661-0104.





NuBus Adapter, Macintosh Centris 660AV

661-1719





Plug, Expansion, Pkg. of 5

922-0902

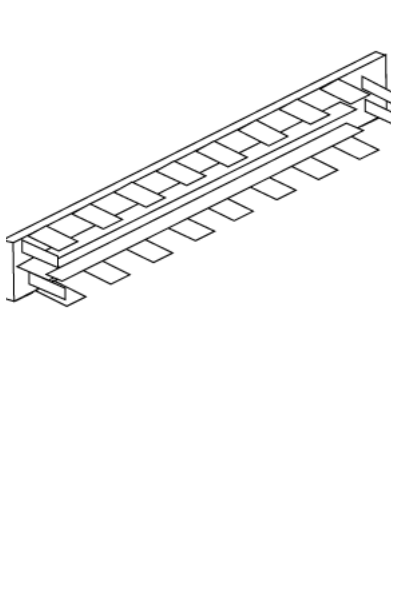



Power Supply, 86 W

661-1688



The Macintosh 86 watt power supply has the assembly part number 614-0022 on the module label.





Screw, Floppy Drive

844-0018

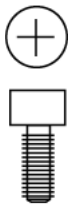



Screw, M3X.5x8mm

410-1308





Screw, M3x8mm, Pan Head, Philips, Pkg. of 10

922-0401

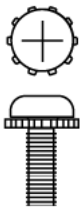



Screw, Nubus Adapter Bracket

450-0032





Screw, Sems 6-32x.313 PN CRS (Replaced by 922-1381)

440-6105

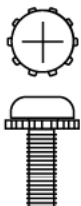



Screw, Sems 6-32x.313 PN CRS

922-1381





Shield, 5.25 Drive Bay

922-0366

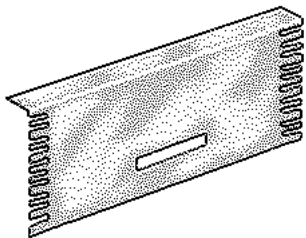



Shield, CD-ROM (replaced by 922-0826)

922-0400

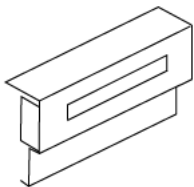



Shield, CD-ROM Drive, Trayloading, Pkg. of 10

922-0826

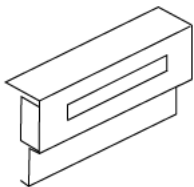



Shield, Hard Drive

922-0367

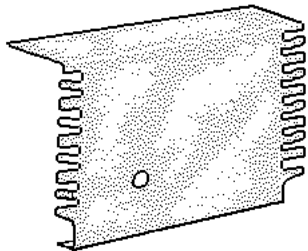



SIMM, DRAM, 16 MB, 80ns, 72-Pin

661-0087

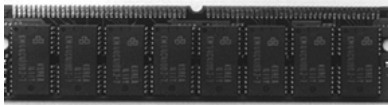

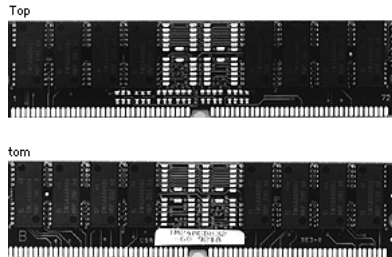
**SIMM, DRAM, 8 MB, 60ns, 72 Pin****661-1702**

This board has ICs on both sides. The RAM speed is usually indicated by a number after a dash or after a letter at the end of the manufacturer's part number. For example, -80, -8 or S8 indicates 80ns, where as -60, -6, or S6 indicates 60 ns. These numbers are located on the surface of the chip or on the back side of the SIMM board. Apple accepts only 60 ns or faster RAM SIMMs of this 8 MB variety for return.

These SIMMs can be used in the following computers and printers:

- Power Macintosh 6100/60, 6100/60AV, and WGS 6150
- Power Macintosh 7100/66 and 7100/66AV
- Power Macintosh 8100/80, 8100/80AV, and WGS 8150
- Workgroup Server 9150
- Macintosh LC 520
- Mac TV
- Macintosh Quadra 605





- Macintosh Quadra 800 and Apple Workgroup Server 80
- Macintosh Quadra 840AV
- Macintosh Quadra/Centris 610
- Macintosh Quadra/Centris 650
- Macintosh Quadra/Centris 660AV
- Macintosh LC III/Performa 450, 460, 466, and 467
- Macintosh LC 475/Quadra 605/Performa 475 and 476
- LaserWriter Pro 600 and 630
- LaserWriter Select 310





Speaker

922-0353





Exploded View

Centris 660AV/Quadra 660AV





Exploded View Quadra 660AV, Centris 660AV

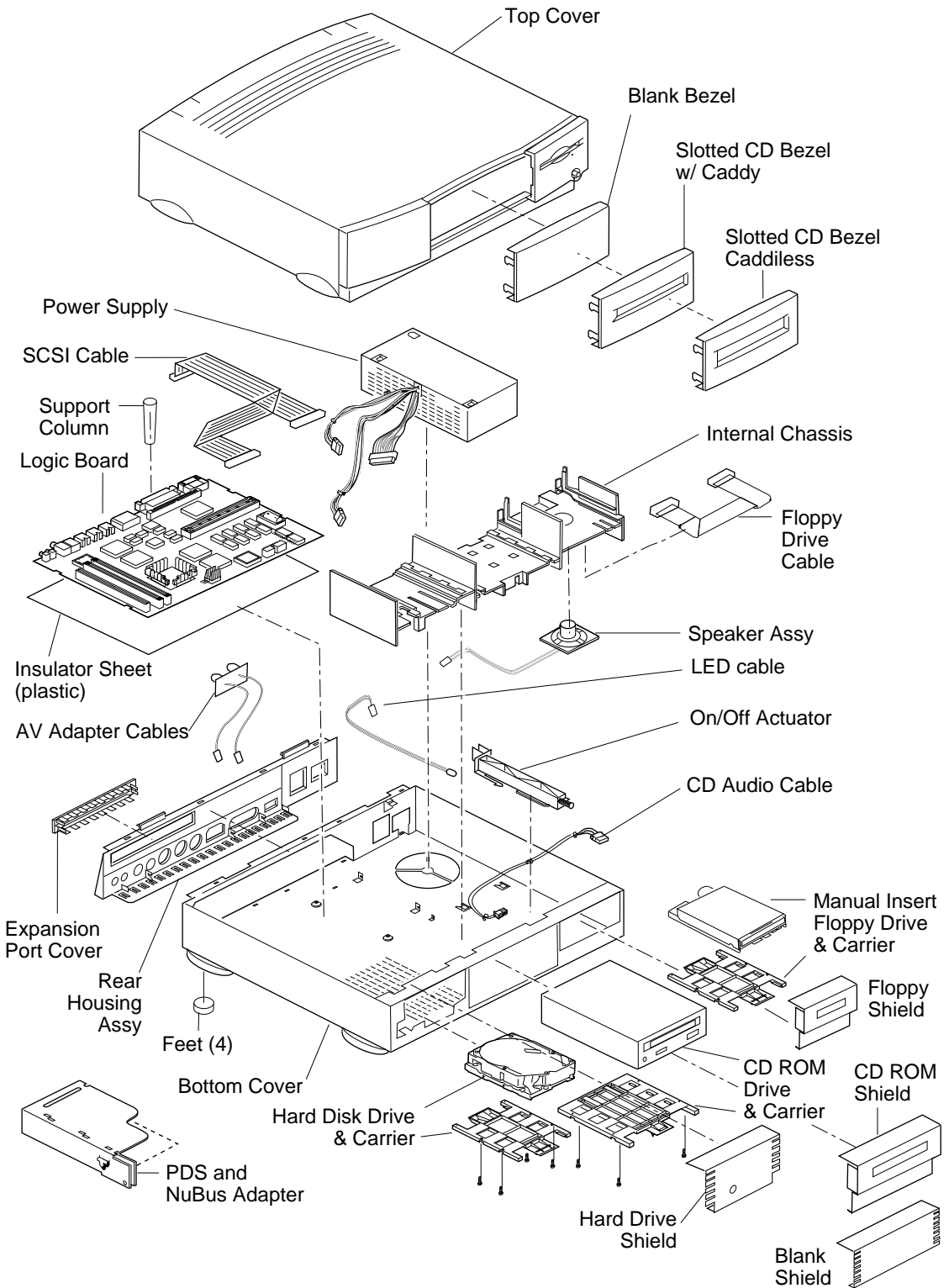

This is a generic representation of a product family. Configurations may vary.

